



LDSBus Dissolved Oxygen Sensor Adapter



1 Introduction

The LDSBus Dissolved Oxygen (DO) Sensor Adapter is designed to work with an analog galvanic probe to form a complete DO sensor. A BNC connector is built into the adapter for attaching such a probe.

The adapter and probe are calibrated using a single-point calibration procedure and the resulting sensor supports DO measurements ranging from 0 to 20 mg/L with a resolution of 0.01mg/L.

The sensor is suitable for use in water quality measurement applications such as nutrient tanks, fisheries and hatcheries, water treatment and sewage treatment plants, swimming pools, aquariums, and many other applications. Monitoring, alerting, and controlling the system can be done in real-time.

1.1 Features

- DO Sensor Adapter integrates directly with Analog Galvanic Dissolved Oxygen probe via BNC connector
- DO measurement range of 0 to 20 mg/L with linearized output and 0.01mg/L resolution
- Single Point step-by-step guided calibration
- BRTSys's LDSBus protocol. Wired data/power transmission through LDSBus HVT-Junction
- High report rate of 1 report every 5 seconds
- Low power consumption 88mW (5V)
- Operating temperature range: 0°C to +70°C
- Flush Mount and DIN Rail Mount options
- Supported platform applications: BRTSys's IoTPortal and LDSBus Python SDK

(Visit <https://brtsys.com/resources>)



Neither the whole nor any part of the information contained in, or the product described in this manual, may be adapted, or Reproduced in any material or electronic form without the prior written consent of the copyright holder. This product and its documentation are supplied on an as-is basis and no warranty as to their suitability for any particular purpose is either made or implied. BRT Systems Pte Ltd will not accept any claim for damages howsoever arising as a result of use or failure of this product. Your statutory rights are not affected. This product or any variant of it is not intended for use in any medical appliance, device, or System in which the failure of the product might reasonably be expected to result in personal injury. This document provides preliminary information that may be subject to change without notice. No freedom to use patents or other intellectual property rights is implied by the publication of this document. BRT Systems Pte Ltd, 178 Paya Lebar Road, #07-03, Singapore 409030. Singapore Registered Company Number: 202220043R.

2 Part Numbers

Part#	Naming
LS100101A	LDSBus Dissolved Oxygen Sensor Adapter
LA120101A	LDSBus DIN Rail Mount Set

Table of Contents

1	Introduction	1
2	Part Numbers	2
3	Product Specifications.....	4
4	Hardware Features.....	5
5	Sensor Configuration and Installation.....	6
5.1	Connection Diagram.....	6
6	Mounting Options	7
6.1	Flush Mount	7
6.2	DIN Rail Mount.....	7
7	System Status LED Indicators	8
8	Probe Selection	9
9	Mechanical Dimension.....	10
10	Contact Information.....	11
	Appendix A – References	12
	Document References	12
	Acronyms and Abbreviations	12
	Appendix B – List of Figures and Tables.....	13
	List of Figures	13
	List of Tables.....	13
	Appendix C – Revision History	14

3 Product Specifications

Features	Interface	BNC – DO probe connector RS485 – LDSBus communication
	LED Indicator (RGB)	System Status Indicator (Please refer to LED section)
	Mounting	Flush Mount DIN Rail Mount
Power	Input Voltage	5V DC Bus Power
	Typical Power	5V, 88mW
	Max. Power	223mW
DO Sensor input module	Detection Range	0– 20 mg/L
	Resolution	0.01mg/L
	Response Time	<1Minute
	Calibration	1 Point Calibration
Physical Characteristics	Color	White
	Housing	Polycarbonate
	Dimensions	L117.6mm x W42.9mm x H29.7mm
Environmental Limits	Operating Temperature	0 to 70°C
	Storage Temperature	-20 to 85°C
	Ambient Relative Humidity	5 to 95% (non-condensing)
Package Contents	Device	1x LDSBus Dissolved Oxygen Sensor Adapter
	Installation (Optional)	1x DIN Rail Bracket set
	Wire Assembly	1X 5m RJ11 Cable

Table 1 - LDSBus Dissolved Oxygen Sensor Adapter Specifications

4 Hardware Features

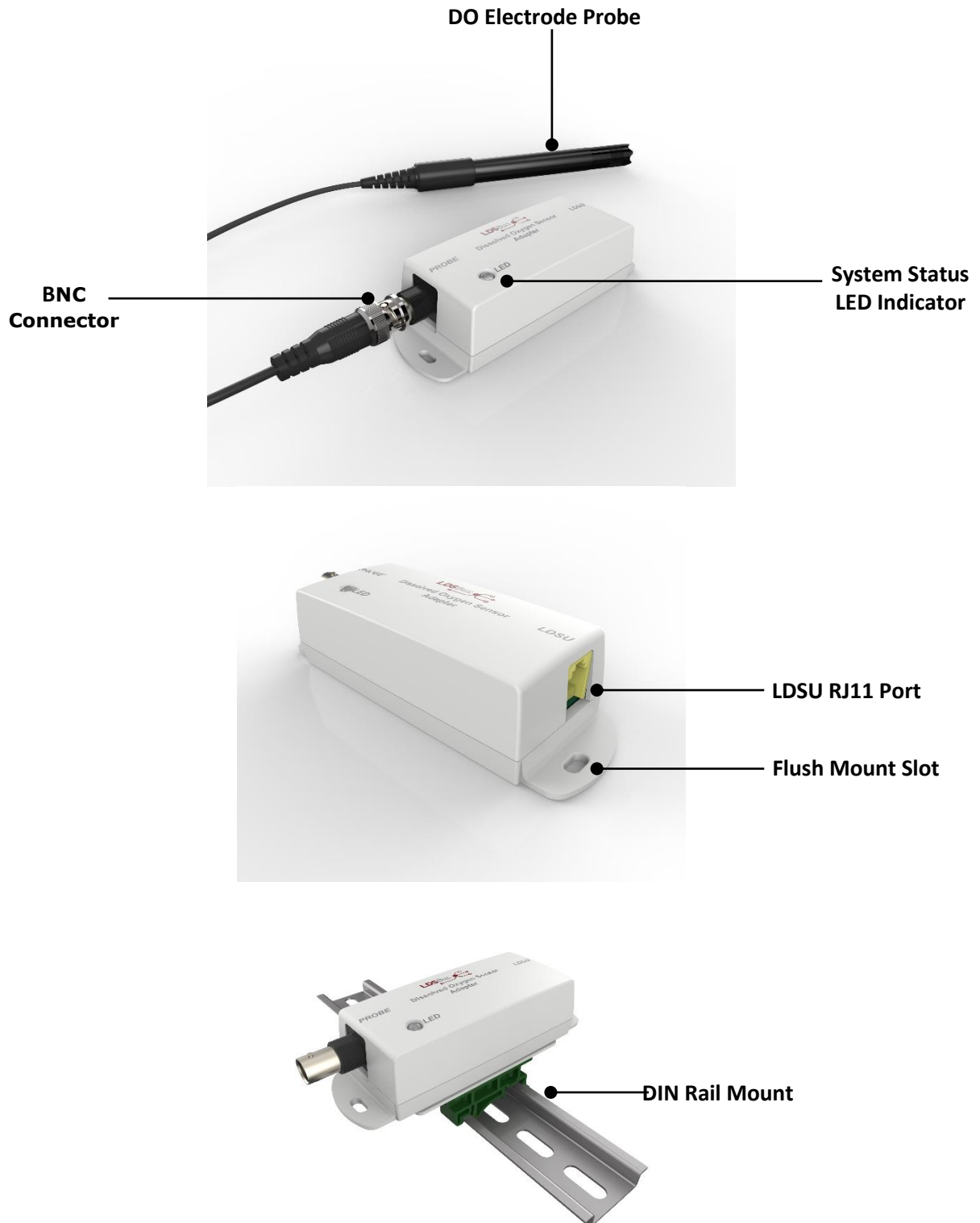

Figure 1 - LDSBus Dissolved Oxygen Sensor Adapter Hardware Features

5 Sensor Configuration and Installation

Please visit <https://brtsys.com/resources> to access the LDSBus Configuration Utility Guide on how to configure the device name, address, and termination settings before using it for your application.

5.1 Connection Diagram

Figure 2 illustrates the connection of the LDSBus DO Sensor Adapter (LDSBus Device) to the LDSBus. Please visit <https://brtsys.com/resources> to view the full device application, setup, and installation guides.

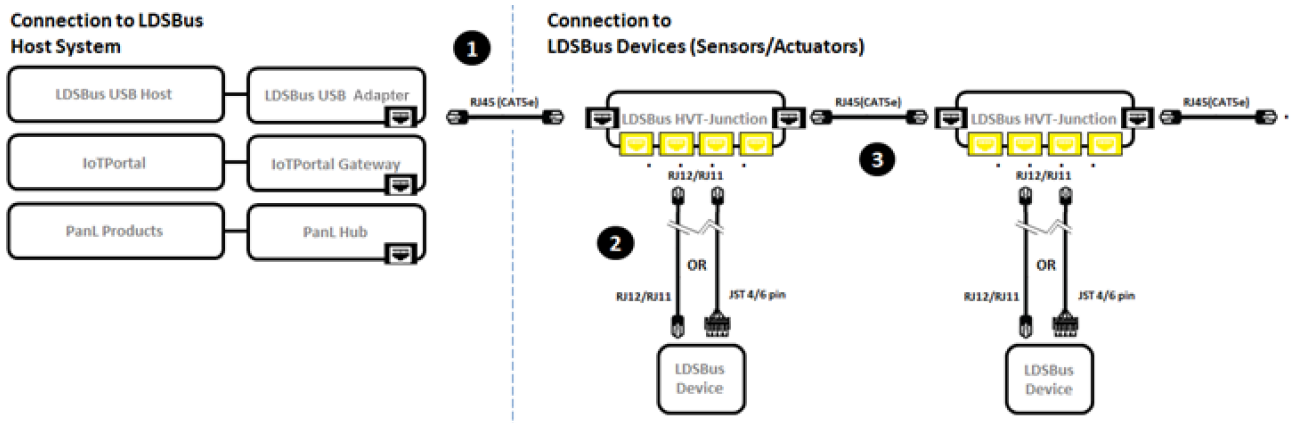

Figure 2 - LDSBus Dissolved Oxygen Sensor Adapter to LDSBus - Connection Diagram

Setup Instructions:

1. Connect the first LDSBus HVT-Junction to any of the LDSBus Host Systems using the RJ45 (CAT5e) cable.
2. Connect the configured LDSBus DO Sensor to the LDSBus HVT-Junction as shown in Figure 2.
3. If there is more than one LDSBus HVT-Junction, chain them together as shown in Figure 2.

6 Mounting Options

6.1 Flush Mount

The LDSBus DO Sensor Adapter can be flush mounted directly on a wall or any flat surface using 2 M3.5*16mm (thread) screws.

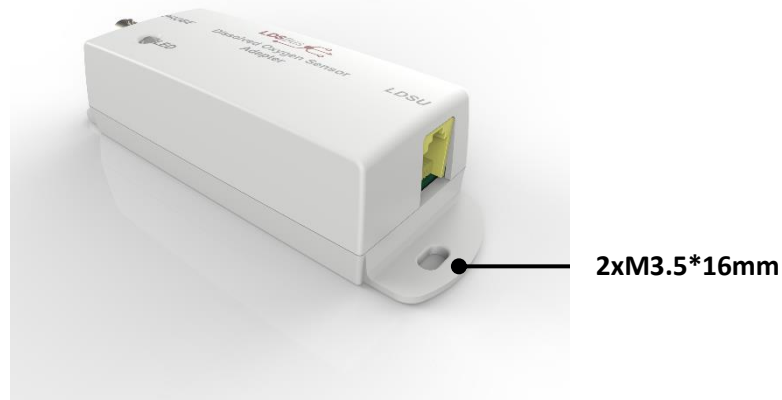

Figure 3 - LDSBus Dissolved Oxygen Sensor Adapter Flush Mount

6.2 DIN Rail Mount

The DIN Rail Mount can be fixed using a DIN Rail bracket that has two mounting holes. The package includes mounting screws and a backplate. (The DIN Rail Bracket is not included in the package).

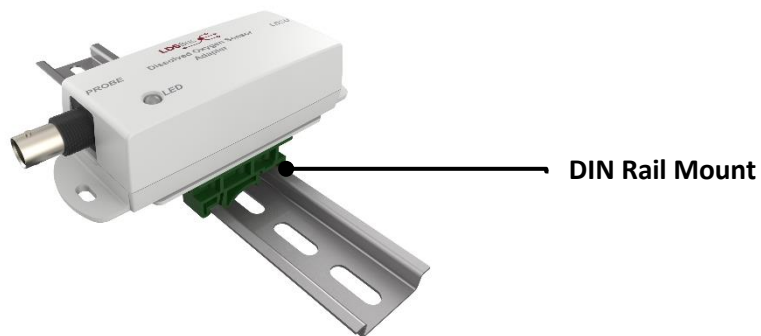

Figure 4 - LDSBus Dissolved Oxygen Sensor Adapter DIN Rail Mount

7 System Status LED Indicators

LDSU devices come with an RGB LED (4 status colors) as mentioned in the table below.

Status display colors

- | | | | |
|----|--------|---|--|
| 1. | RED | - | Device in error condition |
| 2. | YELLOW | - | Un-configured device |
| 3. | GREEN | - | Device in normal state (Device termination is OFF) |
| 4. | BLUE | - | Device in normal state (Device termination is ON) |









Device Status	LED Color		Flashing Frequency	Description
Un-configured device	YELLOW		LED flashing @1Hz	Un-configured device with factory default address (126)
Configured device	GREEN		Steady-Non-flashing	Configured device (Device ID 1-125) and device is idle
	BLUE			
Addressed device	GREEN		LED flashing @5Hz	Device is busy communicating
	BLUE			
Identified device	GREEN		LED flashing @1Hz	Device in identify state
	BLUE			
Device error	RED		Steady – Non-flashing	Device error has occurred
Firmware update	YELLOW		Steady – Non-flashing	Device firmware update

Table 2 – LDSBus Dissolved Oxygen Sensor Adapter – System Status LED Indicator

8 Probe Selection

The following specifications are recommended for selecting Dissolved Oxygen Probe -

Type	:	Galvanic Probe
Detection Range	:	0-50mg/L
Connector	:	BNC

For more information on calibration, please refer to
[BRTSYS AN 001 LDSBus Configuration Utility Guide](#)

9 Mechanical Dimension

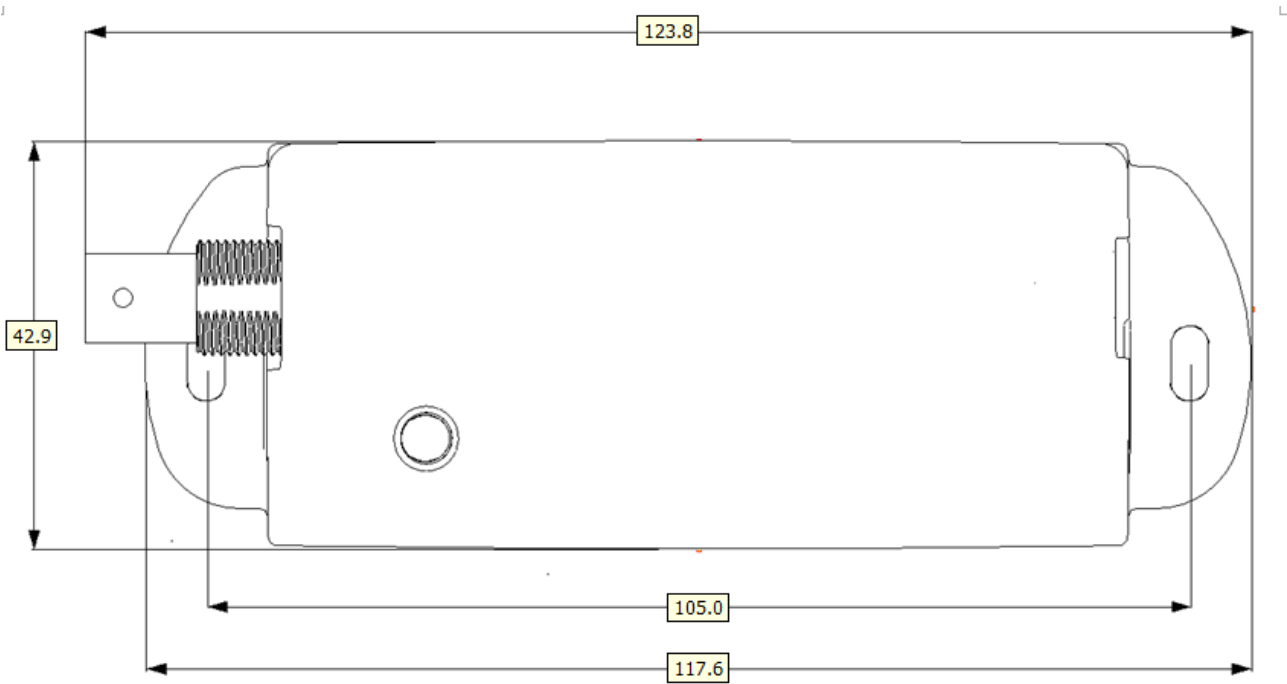

Figure 5 – LDSBus Dissolved Oxygen Sensor Adapter Dimension – Top View



Figure 6 – LDSBus Dissolved Oxygen Sensor Adapter Dimension – Side View

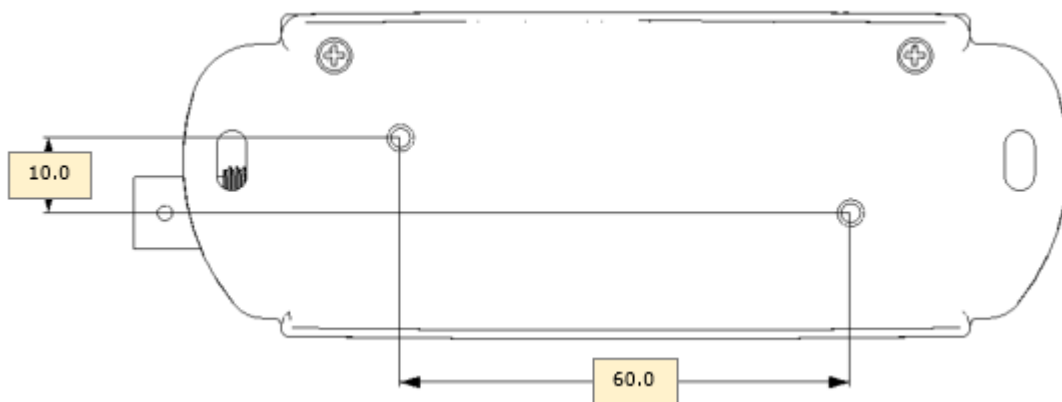

Figure 7 – LDSBus Dissolved Oxygen Sensor Adapter Dimension – Bottom View

Note: All dimensions are in millimetres.

10 Contact Information

Head Quarters – Singapore

BRT Systems Pte Ltd
178 Paya Lebar Road, #07-03
Singapore 409030
Tel: +65 6547 4827
Fax: +65 6841 6071

E-mail (Sales) sales@brtsys.com
E-mail (Support) support@brtsys.com

Web Site

<http://brtsys.com/>

Distributor and Sales Representatives

Please visit the Sales Network page of the [BRT Systems Web site](#) for the contact details of our distributor(s) and sales representative(s) in your country.

System and equipment manufacturers and designers are responsible to ensure that their systems, and any BRT Systems Pte Ltd (BRTSys) devices incorporated in their systems, meet all applicable safety, regulatory and system-level performance requirements. All application-related information in this document (including application descriptions, suggested BRTSys devices and other materials) is provided for reference only. While BRTSys has taken care to assure it is accurate, this information is subject to customer confirmation, and BRTSys disclaims all liability for system designs and for any applications assistance provided by BRTSys. Use of BRTSys devices in life support and/or safety applications is entirely at the user's risk, and the user agrees to defend, indemnify, and hold harmless BRTSys from any and all damages, claims, suits, or expense resulting from such use. This document is subject to change without notice. No freedom to use patents or other intellectual property rights is implied by the publication of this document. Neither the whole nor any part of the information contained in, or the product described in this document, may be adapted, or reproduced in any material or electronic form without the prior written consent of the copyright holder. BRT Systems Pte Ltd, 178 Paya Lebar Road, #07-03, Singapore 409030. Singapore Registered Company Number: 202220043R.

Appendix A – References

Document References

[BRTSYS AN 001 LDSBus Configuration Utility Guide](#)

Acronyms and Abbreviations

Terms	Description
DO	Dissolved Oxygen
LDSBus	Long Distance Sensor Bus
LED	Light Emitting Diode

Appendix B – List of Figures and Tables

List of Figures

Figure 1 - LDSBus Dissolved Oxygen Sensor Adapter Hardware Features.....	5
Figure 2 - LDSBus Dissolved Oxygen Sensor Adapter to LDSBus - Connection Diagram	6
Figure 3 - LDSBus Dissolved Oxygen Sensor Adapter Flush Mount	7
Figure 4 - LDSBus Dissolved Oxygen Sensor Adapter DIN Rail Mount	7
Figure 5 - LDSBus Dissolved Oxygen Sensor Adapter Dimension – Top View	10
Figure 6 - LDSBus Dissolved Oxygen Sensor Adapter Dimension – Side View.....	10
Figure 7 - LDSBus Dissolved Oxygen Sensor Adapter Dimension – Bottom View	10

List of Tables

Table 1 - LDSBus Dissolved Oxygen Sensor Adapter Specifications	4
Table 2 - LDSBus Dissolved Oxygen Sensor Adapter – System Status LED Indicator.....	8

Appendix C – Revision History

Document Title: LDSBus Dissolved Oxygen Sensor Adapter Datasheet
Document Reference No.: BRTSYS_000012
Clearance No.: BRTSYS#010
Product Page: <https://brtsys.com/ldsbus/>
Document Feedback: [Send Feedback](#)

Revision	Changes	Date
Version 1.0	Initial Release	04-03-2022
Version 1.1	Updated release under BRT Systems	15-09-2022
Version 1.2	Corrected BRTSYS to BRTSys	24-03-2023