



**INTELLINET**  
NETWORK SOLUTIONS

**manhattan**  
Life just got easier.™

SOLUCIONES DE AUDIO Y VIDEO



RED ACTIVA



CATÁLOGO  
2020

ACCESORIOS Y PERIFÉRICOS



RED PASIVA



CABLES Y ADAPTADORES





**Intellinet Network Solutions®** ofrece productos de red confiables para soluciones tanto de red activa, como de red pasiva. Hacemos esto enfocados en la calidad, innovación y rendimiento a precios razonables.

Nuestra línea está diseñada para brindar soluciones en la variedad de entornos y necesidades de infraestructura a la que se enfrentan nuestros integradores en el día a día. Es por eso que todos nuestros productos de red cumplen o exceden con los estándares y normas.



# CABLEADO ESTRUCTURADO



## RED PASIVA

Intellinet® le ofrece la gama más completa de productos en red activa y red pasiva que satisface con seguridad, calidad y variedad sus necesidades de productos para sus instalaciones de cableado estructurado. Contamos con gabinetes de piso, mural y esquina, así como todos los accesorios para poder hacer instalaciones profesionales con todo lo que se requiere.



Páneles de parcheo



Cables de red



Organizadores



Charolas

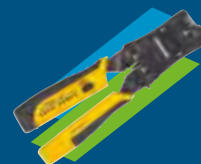

Herramientas



Switches



Barras multicontacto



KVM



Switch PoE



Inyectores PoE

## RED ACTIVA

El mundo actual se encuentra en constante comunicación, por lo que, es difícil prescindir de las telecomunicaciones. Es importante contar con una infraestructura que las respalde, disminuyendo el riesgo de comprometerlas. Así como indispensable contar con los mejores racks, así como todos los accesorios que se requieren para tener un cuarto de telecomunicaciones confiable.

# ÍNDICE

## Red activa



Switches PoE/PoE+	05
Switches Fast y Gigabit Ethernet	08
Inyectores PoE	10
Extensores PoE	10
Transceptores	11
Convertidores de Medios	12
Switches y consolas KVM	12
Kit de red inalámbrica (Mesh)	13

## Red pasiva



Bobinas Cat5e, Cat6 y Cat6a	16
Cables de red Cat5e	17
Cables SOHO	17
Cables de red Cat6 y Cat6a	18
Plugs, jacks y coples	19
Distribuidores, cajas y tapas	21
Páneles de parcheo	23
Probadores de cables	25
Herramientas	25
Tarjetas de red	26
Adaptadores	27
Gabinetes	28
Racks	37
Charolas	39
Unidades de extracción de aire	42
Páneles de tapa ciega	42
Organizadores de cables	42
Tornillería	43
Barras multicontactos	44

## Soluciones de video



Soportes	48
Cajas de conexión	62
Cables HDMI	63
Adaptadores HDMI	65
Cables SVGA	67
Cables DisplayPort	68
Convertidores para conectar video	70
Dispositivos de video	80

## Cables y adaptadores para datos y energía



Cables USB	86
Otros cables	91
Convertidores de USB a otros puertos de datos	96

## Accesorios y periféricos



Energía	102
Hubs USB	104
Lectores de tarjetas	107
Mouse y teclados	109
Audífonos	111
Maletines y Back Packs	112
Candados de seguridad	113
Ensambladores	114
Mantenimiento y limpieza	116
Lectores de tarjetas	118
Tarjetas para PC	118
Lectores de códigos de barra	121
Cámaras de vigilancia	122



# RED ACTIVA

Sabemos la importancia de tus instalaciones de TI, por lo que Intellinet se compromete contigo ofreciéndote equipos activos, capaces de llevar el nivel de tu red a su mejor desempeño.

## En nuestra línea activa encontrarás:

- Switches Automáticos
- Switches Administrables Capa 2 (L2/L2+)
- Switches PoE
- Inyectores PoE
- Extensores
- Switches KVM
- Transceptores SFP
- Convertidores de medios

Todos los productos Intellinet, han aprobado las pruebas de **calidad, funcionamiento y desempeño** solicitados por normativas y estándares, lo que nos da la tranquilidad de ofrecerte soluciones confiables para cada instalación que realizas.

# SOLUCIONES PoE

Nuestros productos con Tecnología Power Over Ethernet cumplen los estándares IEEE 802.3af y 802.3at, haciéndolos compatibles con cualquier dispositivos PoE y PoE+, tales como Access Points (AP), teléfonos IP, cámaras de videovigilancia, sistemas de control BAS, routers, entre otros más.

Nuestra línea de productos PoE consta de:

Switches · Inyectores · Extensores · Pánel de parcheo PoE · Probadores

## “PREPÁRATE PARA EL FUTURO CON NUESTROS SWITCHES POE DE ALTO RENDIMIENTO”

Olvídate del tiempo de instalación, los gastos de cableado eléctrico y minimiza el antiestético desorden causado por las fuentes de alimentación en lugares incómodos como techos y paredes. El sistema de protección de los Switches PoE de Intellinet, mantienen tus equipos protegidos de cortocircuitos, sobrecargas y alta tensión.



## GRANDES BENEFICIOS AL MENOR COSTO

- De 4 hasta 48 puertos PoE
- 100 m de alcance por puertos
- Reduce costos por instalaciones
- Protección contra sobrecargas
- Ahorra energía
- Soporte técnico en producto
- Alta calidad de manufactura
- Compatibilidad con accesorios PoE de otras marcas

Los Switches PoE de Intellinet cumplen los estándares 802.3 af/at y brindan una potencia de hasta 30 W por puerto.

**561228. Switch PoE+ 5 Puertos Gigabit Ethernet para escritorio**



**5** 

Soporta 5 puertos PoE/PoE+



Presupuesto de energía: 60 Watts



Escritorio

**561082. Switch con 5 puertos Gigabit alimentado por PoE**



**PRODUCTO DESTACADO**

La alimentación del Switch puede ser por un inyector, un Switch PoE o por corriente eléctrica (CA).

**5** 

Soporta 5 puertos PoE



Presupuesto de energía, conectando el adaptador de corriente AC: 68 Watts



Presupuesto de energía, si el Switch se alimenta de un PD: 26Watts



Escritorio

**560764. Switch PoE+ Fast Ethernet de 8 puertos para escritorio**



**8** 

Soporta 8 dispositivos PoE



Presupuesto de energía: 140 Watts



Escritorio

**560757. Switch con 8 puertos Fast Ethernet, 4 estándar/4 PoE+**



**4** 

4 puertos PoE/PoE+

**4** 

4 puertos estándar para voz y datos



Presupuesto de energía: 36 Watts



Escritorio

**561358. Switch Web-Smart de 8 puertos Fast Ethernet PoE+ con 1 puerto Gigabit Combo**



**8** 

Soporta 8 dispositivos PoE



Presupuesto de energía: 130 Watts

**SFP** 

Incluye 1 puerto SFP

Montaje en rack o escritorio

**561204. Switch PoE+ Gigabit Ethernet de 8 puertos**



**8** 

Soporta 8 dispositivos PoE



Presupuesto de energía: 60 Watts



Escritorio

**560641. Switch PoE+ Gigabit de 8 puertos, de escritorio**



**8** ⚡

Soporta 8 dispositivos PoE

⚡

Presupuesto de energía: 140 Watts

🏠 📦

Montaje en rack o escritorio

**561167. Switch de 8 puertos Gigabit Ethernet PoE+ Administrable por Web con 2 puertos SFP**

✓ Administrable

**PRODUCTO DESTACADO**



**QoS**

Calidad de Servicio

**VLAN**

Redes virtuales

**8** ⚡

Soporta 8 dispositivos PoE

⚡

Presupuesto de energía: 140 Watts

**SFP**

2 puertos SFP

🏠 📦

Montaje en rack o escritorio

💡

Dispositivo de monitoreo de poder

**560849. Switch Poe Fast Ethernet 30W, 16 Puertos Rj45 PoE+**



**16** ⚡

Soporta 16 dispositivos PoE

⚡

Presupuesto de energía: 240 Watts

📦

Montaje en rack

**561341. Switch administrable de 16 puertos Gigabit Ethernet PoE+ con 2 puertos SFP**

✓ Administrable

**PRODUCTO DESTACADO**



**QoS**

Calidad de Servicio

**VLAN**

Redes virtuales

**16** ⚡

Soporta 16 dispositivos PoE

⚡

Presupuesto de energía: 220 Watts

**SFP**

2 puertos SFP

📦

Montaje en rack

💡

Dispositivo de monitoreo de poder

**561242. Switch PoE+ de 24 puertos Gigabit Ethernet con 2 Puertos SFP**

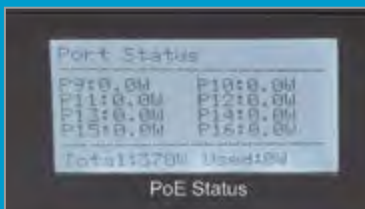

**Innovadora pantalla LCD**

Proporciona información de alimentación en tiempo real.

- Consumo por dispositivo.
- Consumo combinado de todos los dispositivos

Informa de advertencias de sobrecarga, alta temperatura, protección contra cortocircuitos y otras. Siempre se mantendrá informado sobre el estado de su Switch PoE con un vistazo rápido a la pantalla.

**24** ⚡

Soporta 24 dispositivos PoE

⚡

Presupuesto de energía: 370 Watts

**SFP**

2 puertos SFP

📦

Montaje en rack

**LED**

Display LCD

- Dos ventiladores de alto volumen aseguran una ventilación perfecta
- La función Green Ethernet desactiva el consumo de corriente en los puertos no utilizados, y en los utilizados, los ajusta dependiendo de la longitud del cable

**PRODUCTO DESTACADO**





**560559. Switch Administrable por Web Gigabit Ethernet de 24 puertos PoE+ y 2 puertos SFP** Administrable**PRODUCTO DESTACADO****QoS**

Calidad de Servicio

**VLAN**

Redes virtuales

**24**

Soporta 24 dispositivos PoE



Presupuesto de energía: 240 Watts

**SFP**

2 puertos SFP



Montaje en rack



Dispositivo de monitoreo de poder

**561143. Switch de 24 puertos Gigabit Ethernet PoE+ con enlace a 10 GbE****24**

Soporta 24 dispositivos PoE



Presupuesto de energía: 240 Watts

**SFP**

2 ranuras abiertas SFP de 10 GbE



Montaje en rack

**561112. Switch administrable de 48 puertos Gigabit Ethernet PoE+ con Uplink 10 GbE** Administrable**NUEVO****PRODUCTO DESTACADO**

- Comutación de 136 Gbps
- Administración SNMP y Monitoreo a distancia (RMON)
- Soporta VLAN (Basada en etiquetas y en puertos)
- Incorporación de enlaces (Trunking)
- Powered Device Monitor (PDM), reinicia cualquier dispositivo PoE conectado que no responda o envíe tráfico de red.

**STP**

Spanning Tree Protocol

**VLAN**

Redes virtuales

**QoS**

Calidad de Servicio

**48**

Soporta 48 dispositivos PoE/PoE+



Presupuesto de energía: 400 Watts

**SFP**

2 ranuras abiertas SFP de 10 GbE



Montaje en rack



Dispositivo de monitoreo de poder PDM

## Switches Fast Ethernet y Gigabit Ethernet

Son ideales para la comunicación de tus equipos de TI, tales como teléfonos, computadoras, cámaras IP, impresoras, Access Points (AP) y todos los equipos de comunicación por red.

El sistema de autodetección ayuda a que las redes se mantengan en velocidades de comunicación óptimas.

Las funciones avanzadas de los Switches Administrables establecen reglas de funcionamiento que optimizan tus redes de manera profesional, lo que permite gestionar tus equipos conectados en red de la manera correcta.



**523301. Switch de Oficina Fast Ethernet**



5

5 puertos



Metálico



Escritorio

**523318. Switch de Oficina Fast Ethernet**



8

8 puertos



Metálico



Escritorio

**522595. Switch de Oficina Fast Ethernet de 16 Puertos**



16

16 puertos



Metálico



Escritorio

**520409. Switch Fast Ethernet para Racks y/o Gabinetes**



16

16 puertos



Metálico



Montaje en rack

**Switch Fast Ethernet, Plástico**

**560672. 5 puertos** **560689. 8 puertos**



560689



Función Green Ethernet



Plástico



Escritorio

**Switch de Escritorio Gigabit Ethernet**

**530378. 5 Puertos** **530347. 8 Puertos**



530378



Metálico



Escritorio

**561099. Switch Administrable de 8 puertos Gigabit**

Administrable

**PRODUCTO DESTACADO**



- 8**  8 puertos
- QoS** Calidad de Servicio
- VLAN** Redes virtuales
-  Metálico
-  Escritorio

**Switch Gigabit Ethernet, Plástico**

**560696.** 5 Puertos

**560702.** 8 Puertos



**560702**

-  Función Green Ethernet
-  Plástico
-  Escritorio

**524162. Switch Gigabit Ethernet de 24 puertos**



- 24**  Soporta 24 puertos
-  Metálico
-  Montaje en rack

**561044. Switch de 24 Puertos Gigabit Ethernet con 2 puertos SFP**



- 24**  Soporta 24 puertos
- 2 SFP** 2 puertos SFP
-  Metálico
-  Montaje en rack

**560917. Switch de 24 Puertos Gigabit Ethernet Administrable por Web con 2 puertos SFP**

Administrable

**PRODUCTO DESTACADO**



- 24**  Soporta 24 puertos
- SFP** 2 puertos SFP
- QoS** Calidad de servicio
- VLAN** Redes virtuales
- STP** Spanning Tree Protocol
-  Función Green Ethernet
-  Montaje en rack

**561334. Switch de 48 puertos Gigabit Ethernet administrable por red con 4 puertos SFP**

Administrable

**PRODUCTO DESTACADO**

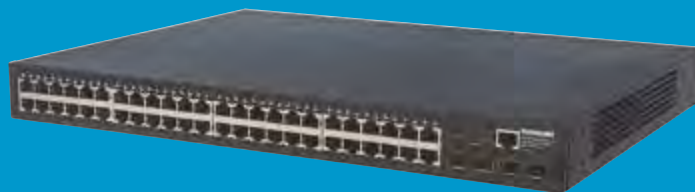

- 48**  Soporta 24 puertos
- SFP** 2 puertos SFP
- QoS** Calidad de servicio
- VLAN** Redes virtuales
- STP** Spanning Tree Protocol
-  Función Green Ethernet
-  Montaje en rack

561464. Switch AV Gigabit Ethernet de 16 puertos

PRÓXIMAMENTE



16

16 puertos  
Gigabit Ethernet



Montaje  
en rack o  
escritorio



Puertos en la  
parte posterior para  
mayor limpieza  
y orden

561471. Switch AV Gigabit Ethernet de 24 puertos

PRÓXIMAMENTE



24

16 puertos  
Gigabit Ethernet



Montaje  
en rack o  
escritorio



Puertos en la  
parte posterior para  
mayor limpieza  
y orden

524179. Inyector PoE



1

Soporta 1  
dispositivo PoE



Velocidad  
Fast Ethernet



Salida de  
energía:  
15.4 Watts



Plástico

561037. Inyector PoE+ Gigabit 30 W



1

Soporta 1  
dispositivo  
PoE/PoE+



Velocidad  
Gigabit Ethernet



Salida de  
energía:  
30 Watts



Plástico

560566. Inyector PoE+ Gigabit 30 W



1

Soporta 1  
dispositivo  
PoE/PoE+



Velocidad  
Gigabit Ethernet



Salida de energía:  
30 Watts



Metálico

561211. Extensor/Repetidor de un Puerto Gigabit PoE+ de alta potencia para exteriores



- Extiende una conexión PoE existente mas allá del límite de los 100 m
- Cubre distancias más largas colocando multiples extensores PoE (Hasta 5 extensores en cascada)

1

Soporta 1  
dispositivo PoE



Salida de  
energía:  
25 Watts



Encadenable:  
Hasta 600 m de  
distancia



IP65 Para  
exteriores

**560962. Extensor/Repetidor de un puerto PoE+ de alta potencia Gigabit**





-  Soporta 1 dispositivo PoE
-  Salida de energía: 25 Watts
-  Hasta 100 m
-  Encadenable: Hasta 600 m de distancia

**720342. Pánel de parcheo activo, 12 puertos PoE**

**PRODUCTO DESTACADO**





-  19" montaje en Rack
- 1U**  
Espacio para montaje en rack
- 24**  
24 puertos RJ-45  
12 puertos para conectar datos  
12 puertos con salida PoE
-  Presupuesto de energía de 120 W

# Transceptores

Nuestros Transceptores SFP (mini-GBIC) cumplen con la especificación MSA, por lo que pueden ser colocados en Switches de la marca Intellinet y de otras marcas, siempre y cuando los Switches cuenten con puertos SFP y sean compatibles con MSA.





**507462. Módulo Transceptor SFP+ 10 Gigabit de Fibra Óptica**

-  Formato SFP+ estándar
-  Tasa de transferencia de datos de 10 Gbps
-  Puerto LC dúplex Multimodo 10 GBase-SR, 300m
- MMF**  
Multi-Mode







**545006. Módulo Transceptor SFP Gigabit de Fibra Óptica**

-  Formato SFP estándar
-  Tasa de transferencia de datos de 1000 Mbps
-  Puerto LC dúplex Multi-Modo 1000Base-SX, 550 m
- MMF**  
Multi-Mode



**523882. Módulo Transceptor SFP Gigabit RJ45 de Cobre**

-  Formato estándar SFP
-  10/100/1000 Mbps Autosensitivo
-  Puerto 1000Base-T (RJ-45)
-  100 m de distancia



**506502. Convertidor de Medios Fast Ethernet**



- Tasa de transferencia de datos: 100 Mbps
- Un puerto RJ45 10/100Base-TX, distancia máxima de 100 m
- Puerto RJ45 con soporte Auto MDI/MDI-X y auto negociación
- Un puerto de Fibra SC dúplex 100Base-FX multi-modo
- Soporta distancias con Fibra: hasta 2 km (cable de 62.5/125 ó 50/125µm)
- Longitud de onda: 1310 nm
- Control de flujo

**506533. Convertidor de Medios Gigabit Ethernet**



- Tasa de transferencia de datos: 1000 Mbps
- Un puerto RJ45 1000Base-T, distancia máxima 100 m (Cat5e o superior)
- Puerto RJ45 con soporte Auto MDI/MDI-X y auto negociación
- Puerto de Fibra 1000Base-SX SC dúplex multi-modo
- Soporta distancias con Fibra: hasta 220 m (cable de 62.5/125 µm) ó 550 m (cable de 50/125 µm)
- Longitud de onda: 850 nm
- Control de flujo

**151245. Mini Switch KVM de 2 puertos**



Opera 2 computadoras con puerto USB con un teclado, ratón y monitor



Resoluciones: Hasta 1920 x 1440 píxeles



Sólo necesita conectar los cables adjuntos

**151269. Switch KVM Compacto 4 puertos**

**151252. 2 puertos**

**151269. 4 puertos**



**151269**



Opera computadoras con puerto USB con un teclado, ratón y monitor



Cambio entre los canales de audio y micrófono



Conexión de PC sin necesidad de apagar ni el switch KVM ni las computadoras

**507059. Consola KVM LCD de 16 puertos para montaje en rack**



Montaje en rack



Soporta 16 puertos



99 teclas



Ajustable con profundidades de 800 a 1200 mm

**506441. Switch KVM de 8 puertos**



Montaje en rack



Opera 8 computadoras con un teclado, ratón y monitor



Conexión de PC sin necesidad de apagar ni el switch KVM ni las computadoras

525725. Kit de red inalámbrica amplia AC1200 - Mesh para extender la red en tu hogar

PRÓXIMAMENTE

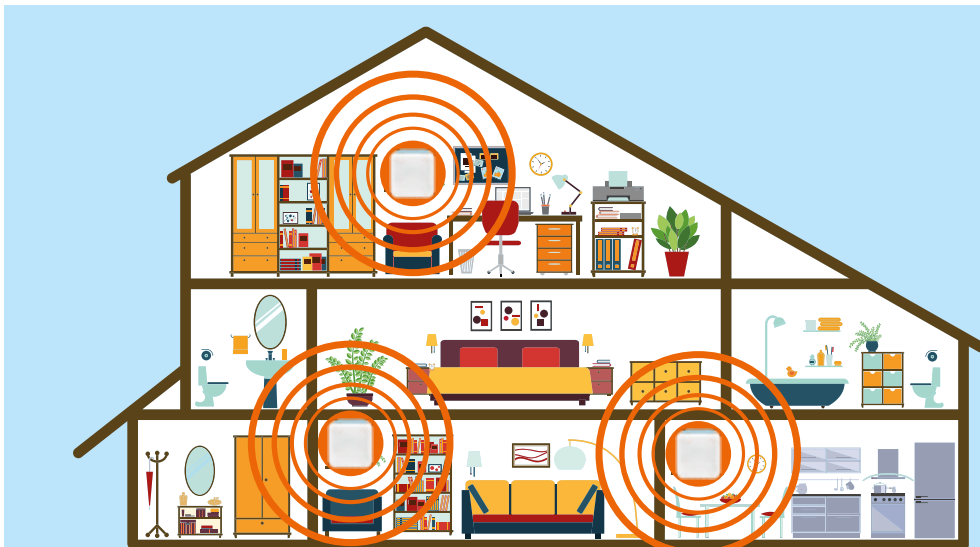

¡Extiende tu red!

El trabajo y el juego son más fáciles y agradables cuando sus computadoras portátiles, teléfonos inteligentes y tabletas pueden conectarse a su red inalámbrica desde casi cualquier lugar de su hogar. El Kit de red inalámbrica AC1200 ofrece conexiones sin complicaciones a su red doméstica en espacios de hasta 420 m<sup>2</sup> para que pueda conectarse en línea rápidamente con la mejor conexión en todo momento.



Ideal para áreas de hasta 420 m<sup>2</sup> (4,500 pies<sup>2</sup>)



Utiliza tecnología de red (mesh) inteligente para encontrar el camino más rápido a Internet



Entrega hasta 867 Mbps en la banda de 5-GHz



300 Mbps en la banda de 2.4-GHz



Fácil instalación



Modem



Wireless Notebook



Tablet



Simplemente toque y conéctese para compartir fácilmente su red inalámbrica.



Rango de 280 a 418 m<sup>2</sup>



# CABLEADO ESTRUCTURADO

La base de un Cableado Estructurado es la Red Pasiva, ya que será la columna vertebral de la comunicación entre los diferentes puntos de conexión. Dentro del cableado estructurado encontraremos los enlaces permanentes y los enlaces de canal, los cuales principalmente se componen de los siguientes elementos:



Gabinetes y Racks



Cable UTP



Páneles de parcheo



Patch Cords



Jacks



Tapas (Faceplate) y cajas

Adicional, los siguientes productos son necesarios para complementar una instalación de cableado estructurado:



Charolas



Herramientas



Probadores



Barras multicontacto (PDU)



Accesorios

Para evitar problemas de compatibilidad es recomendable utilizar productos de la misma categoría, por lo que Intellinet te ofrece la solución completa en las diferentes categorías de cableado estructurado.





# RED PASIVA

Sabemos que su red de cableado estructurado es la base principal en donde convergen voz, datos y video, por lo que la marca Intellinet lo acompaña en esos proyectos de conectividad, ofreciendo productos de calidad y desempeño óptimo para sus redes.

Nuestra solución de Red Pasiva **certificable** te da la confianza de instalar proyectos con productos que sobrepasan los estándares requeridos.

# Cables UTP

De acuerdo al estándar TIA/EIA-568-B, existen diferentes categorías de cableado de red, las cuales se diferencian de acuerdo a su rendimiento en velocidad de transmisión de datos y el ancho de banda. Actualmente, en nuestro país las categorías más populares para la transferencia de datos a través de cable UTP son Cat5e y Cat6.

- **Cat 5e.** Permite una tasa de transferencia de datos de 100 Mbps (redes Fast Ethernet) y una transmisión a frecuencias de 100 Mhz.
- **Cat 6.** Es utilizado para transferencias de datos de hasta 1,000 Mbps (redes Gigabit Ethernet) con un ancho de banda de hasta 250 Mhz.
- **Sólido:** El cable de par trenzado de conductor sólido, incluye un solo filamento dentro de cada pin de los pares del cable. Por sus características físicas su instalación es recomendada en el tendido de la instalación, pues soporta una mayor distancia de transmisión de datos, con una atenuación mínima.
- **Multifilar:** Se refiere a que cada pin del cable de red incluye múltiples filamentos en su interior, permitiendo tener un cable más flexible que permite conectar dispositivos que tendrán diferentes movimientos durante su uso. Es recomendado su uso en distancias cortas y medianas. Ideal para conectar computadoras, puntos de acceso, teléfonos, y otros dispositivos de red.



Bobina Cat5e					
Conductor	Tipo	Calibre	Color	Longitud	Tu bobina
CCA	Multifilar	23 AWG	Gris	100 m	<b>704830</b>
CCA	Multifilar	23 AWG	Gris	305 m	<b>704823</b>
CCA	Sólida	24 AWG	Azul	305 m	<b>◆362344</b>
CCA	Sólida	24 AWG	Gris	305 m	<b>◆362320</b>
100% Cobre	Sólida	24 AWG	Blanca	305 m	<b>333078</b>
100% Cobre	Sólida	24 AWG	Gris	305 m	<b>325899</b>
100% Cobre	Sólida	24 AWG	Gris	305 m	<b>705073</b>

Empaque Reelex para bobina Cat5e



**NUEVO**

Bobina Cat6					
Conductor	Tipo	Calibre	Color	Longitud	Tu bobina
CCA	Sólida	23 AWG	Azul	305 m	<b>◆704670</b>
CCA	Sólida	23 AWG	Gris	305 m	<b>◆704663</b>
100% Cobre	Sólida	23 AWG	Gris	305 m	<b>334136</b>
100% Cobre	Sólida	23 AWG	Azul	305 m	<b>705059</b>

Empaque Reel-in-a-Box para bobina Cat6



**NUEVO**

Bobina SFTP Cat6a					
Conductor	Tipo	Calibre	Color	Longitud	Tu bobina
100% Cobre	Sólida	23 AWG	Azul	305 m	<b>705042</b>
100% Cobre	Sólida	23 AWG	Gris	305 m	<b>705066</b>

**NUEVO**

**NUEVO**

## ¡Actualice su Red!

Disfrute de transmisiones rápidas y claras con velocidades de hasta 10 Gb

- Forro con clasificación CM
- Cable S/FTP para reducir interferencias
- Filamento sólido, 100% cobre
- Ideal para transmisión de video

# Cables Patch

Los Cables Patch Intellinet son parte importante en el desarrollo de soluciones de cableado estructurado y son utilizados en prácticamente cualquier dispositivo de red. Son fabricados con cable UTP y conductores multifilares que brindan una mayor flexibilidad y resistencia al cable.



## Cables de Red Cat5e

- Cobre · Impedancia combinada · Contactos chapados en oro · Chaqueta de PVC única
- Botas sin gancho · Alivio de tensión · Estándares probados



Longitud	Azul	Gris	Blanco	Negro	Rojo	Amarillo	Verde
<b>Cat5e UTP Sin blindaje</b>							
0.5 ft. (0.15 m)	<b>347365</b>	<b>345590</b>		<b>347310</b>			
1.5 ft. (0.5 m)	<b>◆ 318129</b>		<b>345088</b>	<b>318143</b>			
3 ft. (1.0 m)	<b>◆ 318938</b>	<b>◆ 318921</b>	<b>320672</b>	<b>320740</b>	<b>◆ 318952</b>	<b>318969</b>	<b>◆ 318945</b>
5 ft. (1.5 m)	<b>338400</b>	<b>336628</b>	<b>338370</b>	<b>338387</b>			
7 ft. (2.0 m)	<b>◆ 318983</b>	<b>◆ 318976</b>	<b>320689</b>	<b>◆ 320757</b>	<b>319300</b>	<b>319744</b>	<b>318990</b>
10 ft. (3.0 m)	<b>◆ 319775</b>	<b>◆ 319768</b>	<b>320696</b>	<b>320764</b>	<b>319799</b>	<b>319805</b>	<b>319782</b>
14 ft. (5.0 m)	<b>319829</b>	<b>◆ 319812</b>	<b>320702</b>	<b>320771</b>			
25 ft. (7.5 m)	<b>319874</b>	<b>◆ 319867</b>	<b>320719</b>	<b>320788</b>			
50 ft. (15.0 m)	<b>319980</b>	<b>◆ 319973</b>					
100 ft. (30.0 m)		<b>320627</b>					

Cat5e UTP, Blíster	
Longitud	Azul
4.2 m	<b>732666</b>



Cat5e SOHO	
Longitud	Gris
1.0 m	<b>◆ 362221</b>
2.0 m	<b>◆ 362238</b>
3.0 m	<b>362252</b>
7.5 m	<b>362276</b>



¿Ya no tiene clip? Evita cambiar el Plug y repáralo de manera rápida y sencilla.

### Reparadores de Plugs RJ-45



- 771443. Transparente, azul; 50 piezas
- 771436. Transparente; 50 piezas
- 771450. Transparente, colores mixtos; 50 piezas



Plugs  
modulares RJ45



Instalación  
rápida y sencilla



Añade un nuevo seguro a  
los plugs modulares rotos

# Cables de Red Cat6

- Cobre · Impedancia combinada · Contactos chapados en oro · Chaqueta de PVC única
- Botas sin gancho · Alivio de tensión · Estándares probados



Longitud	Azul	Gris	Blanco	Negro	Rojo	Amarillo	Verde
<b>Cat6 UTP Sin blindaje</b>							
0.5 ft. (0.15 m)	<b>347433</b>		<b>347372</b>	<b>347389</b>			
1.5 ft. (0.5 m)	◆ <b>342568</b>	◆ <b>340427</b>	<b>341936</b>	<b>342032</b>	<b>342131</b>	<b>342339</b>	<b>342469</b>
3 ft. (1.0 m)	◆ <b>342575</b>	◆ <b>340373</b>	◆ <b>341943</b>	<b>342049</b>	<b>342148</b>	<b>342346</b>	<b>342476</b>
5 ft. (1.5 m)		<b>340380</b>	◆ <b>341950</b>		<b>342155</b>	<b>342353</b>	<b>342483</b>
7 ft. (2.0 m)	◆ <b>342599</b>	◆ <b>334112</b>	<b>341967</b>	◆ <b>342063</b>	<b>342162</b>	<b>342360</b>	<b>342490</b>
10 ft. (3.0 m)	◆ <b>342605</b>	◆ <b>334129</b>	<b>341974</b>	<b>342070</b>	<b>342179</b>	<b>342377</b>	<b>342506</b>
14 ft. (5.0 m)	<b>343305</b>	<b>336765</b>	<b>343732</b>	<b>343350</b>			
25 ft. (7.5 m)	<b>342629</b>	<b>336758</b>	<b>341998</b>	<b>342094</b>			



## Cables de Red Cat6a



### NUEVOS

Longitud	Azul	Negro
<b>Cat6a</b>		
1ft. (0.3 m)	<b>315982</b>	<b>313834</b>
3 ft. (1.0 m)	<b>741477</b>	<b>741521</b>
7 ft. (2.0 m)	<b>741484</b>	<b>741538</b>
10 ft. (3.0 m)	<b>741491</b>	<b>741545</b>
14 ft. (5.0 m)	<b>741507</b>	<b>741552</b>
25 ft. (7.5 m)	<b>741514</b>	<b>741569</b>

## ¡Mantenga actualizada su red!

Disfrute de transmisiones rápidas y claras, asegurándose que sus datos viajaran seguros con los cables Patch Cat 6a de Intellinet.

- Velocidades de hasta 10 Gb
- Cables S/FTP para reducir interferencias
- 100% cobre
- Contactos chapados con 50 micras de oro
- Forro de PVC para una larga vida útil
- Certificados y aprobados a 500 MHz



## Plugs

Categoría	Tipo de cable	Contenido	Empaque	Descripción	Modelo
Cat5e	Para cable sólido	100 Piezas	Bote	15μ Chapado en oro	<b>502399</b>
Cat5e	Para cable multifilar	100 Piezas	Bote	15μ Chapado en oro	<b>♦ 790055</b>
Cat6	Para cable sólido	100 Piezas	Bote	15μ Chapado en oro	<b>503006</b>
Cat6	Para cable multifilar	100 Piezas	Bote	15μ Chapado en oro	<b>♦ 502344</b>
Cat5e	Para cable sólido	100 Piezas	Bote	50μ Chapado en oro	<b>790512</b>
Cat5e	Para cable multifilar	100 Piezas	Bote	50μ Chapado en oro	<b>790567</b>
Cat6	Terminal de 3 puntas para cable sólido	80 Piezas	Bote	50μ Chapado en oro	<b>790536</b>
Cat6	Terminal de 2 puntas para cable multifilar	90 Piezas	Bote	50μ Chapado en oro	<b>790611</b>



### Plug RJ45, Cat6a. Línea Pro



**790673. Para cable Multifilar. Bote con 80 pzas**  
**790550. Para cable Sólido. Bote con 80 pzas**



Bote con 80 pzas



Contactos chapados con 50 micras de oro.



Incluyen guías y deslizadores



Mayor vida útil



Menor corrosión

### 790482. Plug RJ45, sólido, multifilar UTP Cat6



No requiere herramientas

## UTP

Compatible con cables UTP sólidos y multifilares, calibres 22-26AWG

### Jack Cat5e Keystone

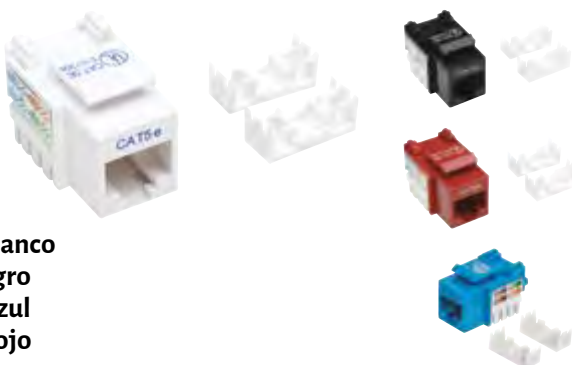

**♦ 210355. Blanco**  
**210416. Negro**  
**♦ 210546. Azul**  
**♦ 210478. Rojo**



Compatible con herramientas de impacto 110 y Krone

## UTP

Uso con cable UTP Cat5e

### Jack Cat6 Keystone

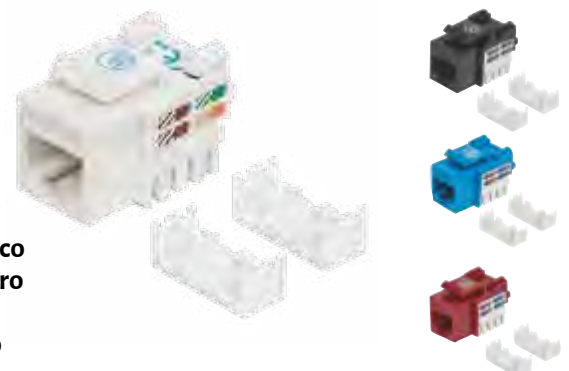

**♦ 210591. Blanco**  
**♦ 210720. Negro**  
**♦ 210737. Azul**  
**♦ 210614. Rojo**



Compatible con herramientas de impacto 110 y Krone

## UTP

Uso con cable UTP Cat6

**◆ 210843. Jack telefónico RJ11/RJ12**



Jack para conectores RJ11 y RJ12



Para telefonía



Tipo Keystone

**Jack tipo Keystone con función de bloqueo de conector. Línea Pro. ¡No necesita herramienta de ponchado!**

**790734. Cat5e**

**790758. Cat6**



No requiere herramientas



Compatible con herramientas de impacto 110 y Krone

**UTP**

Usar con Cable de red UTP

**Cople RJ45 a RJ45 Cat6 Keystone, UTP**

**504898. Negro**

**505147. Blanco**



Contactos chapados con 50 micras de oro

**8P8C**

8P8C hembra a 8P8C hembra

**UTP**

Uso con cable UTP Cat6

**Cople RJ45 a RJ45 Cat5e Keystone, UTP**

**504775. Negro**

**504935. Blanco**



Contactos chapados con 50 micras de oro

**8P8C**

8P8C hembra a 8P8C hembra

**UTP**

Uso con cable UTP Cat5e

**772167. Jack Keystone con puerto USB de carga**



Un puerto de carga USB Tipo A, hembra



Salida 5V / 1A



Diseño de conector Keystone para adaptarse en placas de pared o paneles de parcheo

**◆ 771351. Cople HDMI, Tipo Keystone HDMI hembra a HDMI hembra, blanco**



**CL2**

Para su instalación en muros con cables HDMI CL2



De fácil instalación



Compatible con paneles de parcheo, tapas y cajas de pared

**4K**

Soporta 4K

**504751. Cople RJ45-RJ45 Cat6, modular, blanco, UTP**



Contactos chapados con 50 micras de oro

**8P8C**

8P8C hembra a 8P8C hembra

**UTP**

Uso con cable UTP Cat6

**Cople modular RJ45**

504768. Cat5e

505130. Cat6



Contactos chapados con 50 micras de oro

**8P8C**

8P8C hembra a 8P8C hembra

**FTP**

Uso con Cable de Par Trenzado Forrado (FTP)

**◆ 504225. Cople modular, Hembra a Hembra, RJ45, Cat 5e**



**8P8C**

Cople modular 1 a 1 8P8C

**UTP**

Conecta dos cables UTP para llevar más lejos tu red

**Cople modular RJ45 con función de bloqueo**

790819. Cat5e

790727. Cat6



Contactos chapados con 50 micras de oro

**UTP**

Usar con Cable de red UTP

**504195. Distribuidor Modular RJ-45**



**Ahorra cable en tus conexiones**

- Usar en pares
- Compatible con coples RJ-45 Cat5e y Cat6

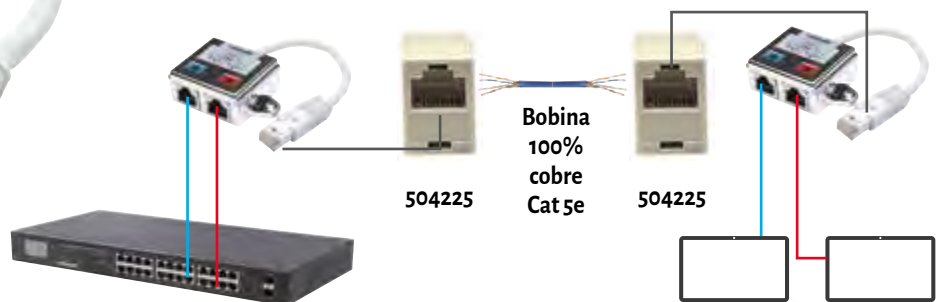

Dos puertos RJ45



Usar en pares

**FTP**

Compatible con cable UTP y FTP

• Cumple el estándar IEEE 802.3u (100Base-TX Fast Ethernet)

Tapa (Faceplate), color blanco

PRÓXIMAMENTE

772389. 1 Perforación

772396. 2 Perforación



◆ 517874. Caja para pared, color blanco



Incluye los tornillos de montaje y cinta adhesiva



Conexión sencilla, 1.89" de profundidad

Caja de pared tipo roseta con función de bloqueo. 2 puertos

790826. Cat5e

771467. Cat6



Compatible con herramientas de impacto 110 y Krone

UTP

Usar con Cable de red UTP

Tapa para caja, blanca



- ◆ 163286. 1 Salida
- ◆ 163293. 2 Salidas
- ◆ 163309. 3 Salidas
- ◆ 163316. 4 Salidas



Montaje a ras de la pared



Se adapta a las cajas estándar

790833. Llave de desbloqueo para línea Pro de jacks, coples y paneles de parcheo



Para paneles de parcheo y accesorios que cuenten con función de bloqueo



Llave para la función de bloqueo de productos



### 720427. Pánel de parcheo



19" montaje en Rack

**24**

24 puertos

**1U**

Espacio para montaje en rack



Administración de cable



### Pánel de Parcheo para Montaje en Pared

**162470.** Cat5e, 12 Puertos

**560269.** Cat6, 12 Puertos



50 micro pulgadas de baño de oro

**UTP**

Uso con cable UTP



Compatible con herramientas de impacto 110 y Krone



### 720342. Pánel de parcheo activo, 12 puertos PoE



19" montaje en Rack

**1U**

Espacio para montaje en rack

**24**

24 puertos RJ-45  
12 puertos para conectar datos  
12 puertos con salida PoE



Presupuesto de energía de 120 W



### Pánel de Parcheo Cat5e

◆ **513555.** 24 Puertos, 1U  
**513579.** 48 Puertos, 2U



50 micro pulgadas de baño de oro

**UTP**

Uso con cable UTP



Compatible con herramientas de impacto 110 y Krone



### Pánel de Parcheo Cat6

◆ **520959.** 24 Puertos, 1U

**560283.** 48 Puertos 2U



50 micro pulgadas de baño de oro

**UTP**

Uso con cable UTP



Compatible con herramientas de impacto 110 y Krone



**Pánel de Parcheo de 24 puertos, con identificación por colores**

513678. Cat5e, 24 Puertos

513692. Cat6, 24 Puertos



Código de color en grupos de 6

**UTP**

Uso con cable UTP

**1U**

Espacio para montaje en rack



**720847. Panel de parcheo vacío modular de 24 puertos**



19" montaje en Rack

**24**

24 puertos

**UTP**

Uso con cable UTP

**1U**

Espacio para montaje en rack



**Pánel de parcheo de mesa con función de bloqueo con conectores. 12 puertos. Línea Pro**

720618. Cat5e

720625. Cat6



**UTP**

Uso con cable UTP

**1U**

Espacio para montaje en rack



Compatible con herramientas de impacto 110 y Krone



Es necesaria la llave de seguridad 790833 la cual se vende por separado.

**Pánel de parcheo con función de bloqueo de conectores. 24 puertos. Línea Pro**

720557. Cat5e

720564. Cat6



**UTP**

Uso con cable UTP

**1U**

Espacio para montaje en rack



Compatible con herramientas de impacto 110 y Krone



Es necesaria la llave de seguridad 790833 la cual se vende por separado.

**790833. Llave de desbloqueo para línea Pro de jacks, coples y páneles de parcheo**



Para páneles de parcheo y accesorios que cuenten con función de bloqueo



Llave para la función de bloqueo de productos

**Compatible con:**

790734	771467
790758	720618
790819	720625
790727	720557
790826	720564



◆ 351898. Probador de cables de red



**RJ11  
-  
RJ45**

Prueba RJ11  
y RJ45

**UTP/  
STP/FTP**

Tipos  
de cable



Los LEDs indican  
continuidad y fallos

351911. Probador de Cables 4 en 1



**RJ11/  
RJ45/USB/BNC**

Prueba RJ11/-45/  
USB/BNC

**180 m**

Distancia máxima  
de prueba



Los LEDs indican  
continuidad y fallos

780094. Probador de cable 5 en 1



**RJ11/  
RJ45/USB/BNC**

Prueba USB/RJ11/RJ45/  
10Base/FireWire

**180 m**

Distancia máxima  
de prueba



Los LEDs indican  
continuidad  
y fallos

515566. Probador y generador de tonos para cableado



Prueba redes de datacom, telecom,  
seguridad, video y audio



LEDs de polaridad  
de línea, continuidad y voltaje

780131. Probador de PoE/PoE+



Detector Power  
over Ethernet que  
confirma conexiones  
PoE y PoE+



Plug  
and Play



Detecta  
IEEE802.3af y  
IEEE802.3at



Detecta el tipo de  
PSE (Fuente de  
poder) ya sea  
Midspan o Endspan

◆ 780070. Kit de herramientas para instalaciones



kit de 4 herramientas para red compuesta por Probador de cable UTP,  
Ponchadora, Pinza Crimpadora y Pelador de cable

**211055. Ponchadora para jacks y p neles de parcheo**



110  
-  
88

Para Terminal Block 110/ 88



Control de presi n de impacto ajustable

**211048. Pinza para crimpear RJ11, RJ12 y RJ45, con trinquete**



RJ45/RJ12  
/RJ11

Para plugs modulares



Corta y quita el forro de cable redondo y plano

**210836. Pinza para crimpear RJ11, RJ12 y RJ45**



RJ45/RJ12  
/RJ11

Para plugs modulares



Corta y quita el forro del cable

**780124. Pinza Crimpeadora Universal de Plugs Modulares y Probador de Cables**

**PRODUCTO DESTACADO**



RJ45/  
RJ22/  
RJ12/RJ11

Para plugs modulares



Corta, pela, remata y prueba cables con una sola herramienta



Prueba cables Cat3, 5e, 6 y 6a



9 indicadores LED



Pruebas hasta 100 m de distancia

**Tarjeta de red Gigabit PCI Express**



**522533. Tarjeta de red Gigabit PCI Express  
522328. Tarjeta de red Gigabit PCI**



Incluye br cket regular y corto



10/100/1000 Mbps



Velocidad Full d plex de 20 Mbps, 200 Mbps, 2000 Mbps

**507950. Tarjeta de red 10 Gigabit PCI Express**

**PRODUCTO DESTACADO**



Provee una tasa de transferencia de datos de hasta 5 Gbps con cable de red Cat6 o de 2.5 Gbps con cable de red Cat5e



Tasa de transferencia de datos de hasta 10 Gbps con un cable de red Cat6a

◆ 506731. Adaptador Fast Ethernet USB de Alta Velocidad 2.0



10 veces más rápido que los adaptadores USB 1.1 a Fast Ethernet



Añada una conexión de red a su PC sin necesidad de abrirla



Perfecto para computadoras de escritorio y portátiles



507578. Hub de 3 puertos USB 3.0 con Adaptador Gigabit Ethernet

PRODUCTO DESTACADO

Agrega una conexión de red Gigabit de alta velocidad y tres puertos USB 3.0 para computadoras portátiles, 2 en 2, Ultrabooks™, dispositivos Surface®, MacBook® y Chromebook™



3 puertos USB 3.0 Superspeed



Un puerto Gigabit Ethernet (RJ45) que soporta una velocidad de transferencia de hasta 2 Gbps full-duplex



Velocidades: Hasta 5 Gbps



◆ 506847. Adaptador Gigabit Ethernet USB de Súper Velocidad 3.0

Agrega una conexión de red Gigabit de alta velocidad para computadoras portátiles, 2 en 2, Ultrabooks™, dispositivos Surface®, MacBook® y Chromebook™



Un puerto Gigabit Ethernet (RJ45) que soporta una velocidad de transferencia de hasta 2 Gbps full-duplex



Actualice la computadora o portátil a velocidad Gigabit



507585. Adaptador de USB-C a Red Gigabit

Agrega una conexión de red Gigabit Ethernet de Alta Velocidad a Notebooks, MacBook® y Chromebook Pixel™ con un conector USB Tipo-C



Un puerto Gigabit Ethernet (RJ45) que soporta una velocidad de transferencia de hasta 2 Gbps full-duplex



USB SuperSpeed 3.1 Generación 1 (5 Gbps); 10/100/1000 Mbps Gigabit Ethernet



# Gabinete profesional para Recarga de Energía

Mantenga 14 dispositivos móviles completamente cargados y resguardados de manera segura.

## 714778. Gabinete profesional para recarga de energía



- Almacena de manera segura hasta 14 dispositivos - 39 x 24.5 x 2.3 cm. Las bahías son compatibles con dispositivos como iPads, Chromebooks, Macbooks, Ultrabooks, tabletas
- Orificios para montaje en pared y cuatro patas de goma para el escritorio
- Dos puertos con cerradura con dos llaves
- Ventilado para una mejor circulación del aire



14 tomas AC para adaptadores de carga



Fabricado en acero, totalmente ensamblado y con espacio para almacenamiento del cable de corriente



Repisas ajustables con divisiones removibles y organizador de cables integrado

## Gabinetes murales

### GABINETES PARA ESQUINAS

#### Gabinete de 19" para Montaje en Esquinas de Pared

19"

Gabinete de 19"



Acero laminado, galvanizado



Puerta delantera reversible



Para montaje en esquinas



Carga estática máxima de 60 kg



Recubrimiento antiestático en todos los paneles



Entrada de cable a través del panel superior o inferior



Puerta de cristal templado que puede ser abierto a más de 180°

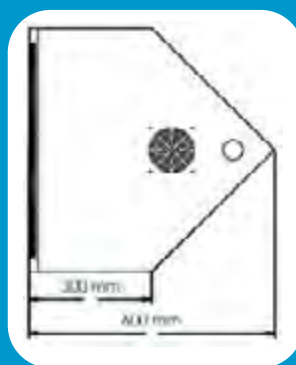

PRODUCTO DESTACADO



Modelo	Pulgadas	U	Altura	Ancho	Profundidad	Envío
714624	19"	6	350 mm	600 mm	430 mm	Ensamblado
714723	19"	6	370 mm	600 mm	600 mm	Ensamblado
714631	19"	9	483 mm	600 mm	430 mm	Ensamblado
714730	19"	9	503 mm	600 mm	600 mm	Ensamblado

## GABINETES PARA ESQUINAS

SKU	DESCRIPCIÓN	714624	714723	714631	714730
		Gabinete 19" Esquina 6U 600*430 Ensamblado	Gabinete 19" Esquina 6U 600*600 Ensamblado	Gabinete 19" Esquina 9U 600*430 Ensamblado	Gabinete 19" Esquina 9U 600*600 Ensamblado
715072	Charola Rack 19", 1U Sólida, 30cm, 25kg		●		●
714884	Charola Rack 19", 1U Ventilada, 30cm, 25kg		●		●
169950	Organizador Horizontal 19", 1U Metálico 5cm	●	●	●	●
714679	Organizador Horizontal 19", 1U Plástico	●	●	●	●
714907	Unidad de extracción de aire 19" con 2 ventiladores y termostato, 1U		●		●
712668	Unidad de extracción de aire 19" con 3 ventiladores, 1U		●		●
714358	Panel Tapa Ciega, 1U, Sin Herramienta, Plástico	●	●		●
714310	Panel Tapa Ciega, 1U, Sin Herramienta, Metal	●	●		●
714341	Panel Tapa Ciega, 2U, Sin Herramienta, Metal	●	●		●
714372	Panel Tapa Ciega, 3U, Sin Herramienta, Metal	●	●		●

GABINETES MURALES DE 19"

Gabinetes para muro

Ensamblado



Modelo	Altura	Ancho	Profundidad	U
203906	351	600	450	6U
203883	485	600	450	9U
203869	618	600	450	12U
203845	751	600	450	15U

Carga estática máxima de 60 kg

Gabinetes murales ECO

Flat-Pack



Modelo	Altura	Ancho	Profundidad	U
711593	359	520	400	7U
711609	448	520	400	9U
711616	520	520	400	12U

Carga estática máxima de 30 kg

Gabinetes para muro

Flat-Pack



Modelo	Altura	Ancho	Profundidad	U
711715	370	570	450	6U
711951	770	570	600	15U

Carga estática máxima de 60 kg

Gabinetes para muro

Ensamblado



Modelo	Altura	Ancho	Profundidad	U
711753	370	600	600	6U
711814	500	600	450	9U

Capacidad de carga 60 kg



## GABINETES MURALES

		711753	711814	711715	711951	203906
SKU	DESCRIPCIÓN	Gabinete 19" Mural 6U 600*600 Ensamblado	Gabinete 19" Mural 9U 600*450 Ensamblado	Gabinete 19" Mural 6U 570*450 Flatpack	Gabinete 19" Mural 15U 570*600 Flatpack	Gabinete 19" Mural 6U 600*450 Ensamblado
710954	Charola Rack 19", 2U Ventilada 35.5cm, 15kg	●			●	
710916	Charola Rack 19", 2U Sólida, 40cm, 25kg	●			●	
715072	Charola Rack 19", 1U Sólida, 30cm, 25kg	●	●	●	●	●
714884	Charola Rack 19", 1U Ventilada, 30cm, 25kg	●	●	●	●	●
712521	Charola Gabinete 19", 1U Fija, 35cm, 50kg	●			●	
130066	Charola Rack 19", 1U Ventilada, 40cm, 50kg	●			●	
712514	Charola Rack 19", 2U Ventilada, 40cm, 25kg	●			●	
714907	Unidad de extracción de aire 19" con 2 ventiladores y termostato, 1U	●	●	●	●	●
712668	Unidad de extracción de aire 19" con 3 ventiladores, 1U	●	●	●	●	●
169950	Organizador Cables 19", 1U Metálico 5cm	●	●	●	●	●
714679	Organizador Cables 19", 1U Plástico	●	●	●	●	●
714686	Organizador Cables 19", 2U Plástico	●	●	●	●	●
168458	Organizador Cables 19", 2U Tapa Plástico	●	●	●	●	●
714655	Organizador Cables Doble 19", 1U Plástico	●	●	●	●	●
714662	Organizador Cables Doble 19", 2U Plástico	●	●	●	●	●
714358	Panel Tapa Ciega, 1U, Sin Herramienta, Plástico	●	●	●	●	●
714310	Panel Tapa Ciega, 1U, Sin Herramienta, Metal	●	●	●	●	●
714341	Panel Tapa Ciega, 2U, Sin Herramienta, Metal	●	●	●	●	●
714372	Panel Tapa Ciega, 3U, Sin Herramienta, Metal	●	●	●	●	●



## GABINETES MURALES

		203883	203869	203845	711593	711609	711616
SKU	DESCRIPCIÓN	Gabinete 19" Mural 9U 600*450 Ensamblado	Gabinete 19" Mural 12U 600*450 Ensamblado	Gabinete 19" Mural 15U 600*450 Ensamblado	Gabinete 19" Mural 7U 600*400 Flatpack	Gabinete 19" Mural 9U 600*400 Flatpack	Gabinete 19" Mural 12U 600*400 Flatpack
710954	Charola Rack 19", 2U Ventilada 35.5cm, 15kg						
710916	Charola Rack 19", 2U Sólida, 40cm, 25kg						
715072	Charola Rack 19", 1U Sólida, 30cm, 25kg	●	●	●	●	●	●
714884	Charola Rack 19", 1U Ventilada, 30cm, 25kg	●	●	●	●	●	●
712521	Charola Gabinete 19", 1U Fija, 35cm, 50kg						
130066	Charola Rack 19", 1U Ventilada, 40cm, 50kg						
712514	Charola Rack 19", 2U Ventilada, 40cm, 25kg						
714907	Unidad de extracción de aire 19" con 2 ventiladores y termostato, 1U	●	●	●	●	●	●
712668	Unidad de extracción de aire 19" con 3 ventiladores, 1U	●	●	●	●	●	●
169950	Organizador Cables 19", 1U Metálico 5cm	●	●	●	●	●	●
714679	Organizador Cables 19", 1U Plástico	●	●	●	●	●	●
714686	Organizador Cables 19", 2U Plástico	●	●	●	●	●	●
168458	Organizador Cables 19", 2U Tapa Plástico	●	●	●	●	●	●
714655	Organizador Cables Doble 19", 1U Plástico	●	●	●	●	●	●
714662	Organizador Cables Doble 19", 2U Plástico	●	●	●	●	●	●
714358	Panel Tapa Ciega, 1U, Sin Herramienta, Plástico	●	●	●	●	●	●
714310	Panel Tapa Ciega, 1U, Sin Herramienta, Metal	●	●	●	●	●	●
714341	Panel Tapa Ciega, 2U, Sin Herramienta, Metal	●	●	●	●	●	●
714372	Panel Tapa Ciega, 3U, Sin Herramienta, Metal	●	●	●	●	●	●

# Gabinetes de 19" para Redes y Servidores

Gabinetes de 19" para redes, 800 mm de profundidad, puerta de cristal



**PROTECCIÓN IP20**

Gabinetes de 19" para servidores, 1000 mm de profundidad, puerta de acero perforado



Gabinetes Ensamblados de 19"				
Modelo	U	Frente	Altura	Profundidad
<b>713542</b>	26	600 mm	1322 mm	800 mm
<b>601597</b>	42	600 mm	2098 mm	800 mm

713542. Capacidad de carga 1,500 kg

Gabinetes Flat-Pack de 19"				
Modelo	U	Frente	Altura	Profundidad
<b>713085</b>	22	600 mm	1120 mm	800 mm
<b>713108</b>	26	600 mm	1284 mm	800 mm
<b>713184</b>	42	600 mm	2057 mm	800 mm
<b>713245</b>	26	600 mm	1322 mm	1000 mm
<b>713276</b>	42	800 mm	2057 mm	1000 mm

Capacidad de carga 1,500 kg

## Presentación Flat-Pack

Hace referencia al tipo de embalaje del gabinete.

Esta presentación permite transportarlo de manera **ágil y sencilla**, evita complicaciones de acceso en espacios angostos, poco cómodos o dificultad para subirlos a pisos altos.

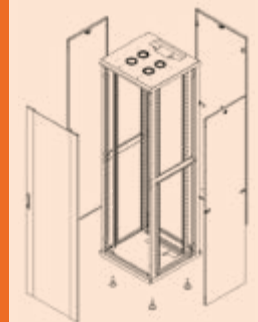

Ahorrarás en costos de transportación.



Ahorro de espacio para el almacenaje



Diseñados para cualquier servidor o equipo activo de 19"



Transportación ágil y sencilla en cualquier zona del edificio

203227. Gabinete 19" para redes, 27 U



19"

Para dispositivos de 19"

27 U

Altura: 27 U



4 extractores de aire de alta potencia



Construido de acero



Carga estática máxima de 800 kg



Puerta con vidrio templado



Frente: 600 mm



Altura: 1386 mm



Profundidad: 900 mm

- Rieles de montaje vertical para ofrecer un montaje universal (EIA-310) para cualquier marca de servidor
- Entradas de cable por las partes superior e inferior
- Bordes frontal y trasero ventilados para entradas de aire
- Las partes están terminadas en pintura tipo polvo para extender su uso y retardar el tiempo de desgaste
- **Presentación Flat-Pack**

167628. Rack mini para muro o escritorio



Para montaje en pared o escritorio

19"

Para dispositivos de 19"



Altura de 7", (4 unidades)



Profundidad de 12" (30 cm)

## GABINETES PARA REDES

		713276	713245	713542	601597
SKU	DESCRIPCIÓN	Gabinete 19" 42U 800x1000 Flatpack	Gabinete 19" 26U 600x1000 Flatpack	Gabinete 19" 26U 600*800 Ensamblado	Gabinete 19" 42U 600*800 Ensamblado
678051	Charola Gabinete 19", 1U Fija, 52.5cm, Ventilada, 50kg	●	●	●	
710954	Charola Rack 19", 2U Ventilada 35.5cm, 15kg	●	●	●	●
710916	Charola Rack 19", 2U Sólida, 40cm, 25kg	●	●	●	●
715072	Charola Rack 19", 1U Sólida, 30cm, 25kg	●	●	●	●
714884	Charola Rack 19", 1U Ventilada, 30cm, 25kg	●	●	●	●
712521	Charola Gabinete 19", 1U Fija, 35cm, Ventilada, 50kg	●	●	●	
130066	Charola Rack 19", 1U Ventilada, 40cm, 50kg	●	●	●	●
712576	Charola Gabinete 19", 1U Fija, 62cm, Ventilada, 100kg	●	●	●	●
712545	Charola Gabinete 19", 1U Fija, 72cm, Ventilada, 50kg	●	●		
712514	Charola Rack 19", 2U Ventilada, 40cm, 25kg	●	●	●	●
677455	Charola Rack 19", 2U Ventilada, 55cm, 25kg	●	●	●	●
712613	Charola Gabinete 19", Ajustable 37-60cm, Deslizable, 1U, Ventilada, 35kg	●	●	●	●
712620	Charola Gabinete 19", Ajustable 60-80cm, Deslizable, 1U, Ventilada, 35kg	●	●	●	●
714389	Charola Gabinete 19", Ajustable 55-100cm, 1U, Ventilada, 45kg	●	●	●	●
714709	Charola Gabinete 19", Ajust 60-80cm, Desliz/Rotación 90°, 1U, 30kg	●	●	●	●
710268	Charola Gabinete 19", Ajustable 60-80cm, Deslizable, 1U, Ventilada, 35kg	●	●	●	●
601290	Charola Gabinete 19", Ajustable 65-85 cm, 2U, Ventilada, 30kg	●	●	●	●
678054	Charola Gabinete 19", Deslizable, 52cm, 1U, Ventilada, 25Kg	●	●		
671075	Charola Gabinete 19", Ajustable 70-90cm, 1U, Ventilada, 100kg	●	●		
714754	Soporte de monitor VESA para Gabinete/Rack 19", 7U	●	●	●	●
714907	Unidad de extracción de aire 19" con 2 ventiladores y termostato, 1U	●	●	●	●
712668	Unidad de extracción de aire 19" con 3 ventiladores, 1U	●	●	●	●

GABINETES PARA REDES

SKU	DESCRIPCIÓN	713085	713108	713184	203227
		Gabinete 19" 22U 600*800 Flatpack	Gabinete 19" 26U 600*800 Flatpack	Gabinete 19" 42U 600*800 Flatpack	Gabinete 19" 27U 600x900 Flatpack
678051	Charola Gabinete 19", 1U Fija, 52.5cm, Ventilada, 50kg				
710954	Charola Rack 19", 2U Ventilada 35.5cm, 15kg	●	●	●	●
710916	Charola Rack 19", 2U Sólida, 40cm, 25kg	●	●	●	●
715072	Charola Rack 19", 1U Sólida, 30cm, 25kg	●	●	●	●
714884	Charola Rack 19", 1U Ventilada, 30cm, 25kg	●	●	●	●
712521	Charola Gabinete 19", 1U Fija, 35cm, Ventilada, 50kg				●
130066	Charola Rack 19", 1U Ventilada, 40cm, 50kg	●	●	●	●
712576	Charola Gabinete 19", 1U Fija, 62cm, Ventilada, 100kg	●	●	●	●
712545	Charola Gabinete 19", 1U Fija, 72cm, Ventilada, 50kg				
712514	Charola Rack 19", 2U Ventilada, 40cm, 25kg	●	●	●	●
677455	Charola Rack 19", 2U Ventilada, 55cm, 25kg	●	●	●	●
712613	Charola Gabinete 19", Ajustable 37-60cm, Deslizable, 1U, Ventilada, 35kg	●	●	●	●
712620	Charola Gabinete 19", Ajustable 60-80cm, Deslizable, 1U, Ventilada, 35kg	●	●	●	●
714389	Charola Gabinete 19", Ajustable 55-100cm, 1U, Ventilada, 45kg	●	●	●	●
714709	Charola Gabinete 19", Ajust 60-80cm, Desliz/Rotación 90°, 1U, 30kg	●	●	●	●
710268	Charola Gabinete 19", Ajustable 60-80cm, Deslizable, 1U, Ventilada, 35kg	●	●	●	●
601290	Charola Gabinete 19", Ajustable 65-85 cm, 2U, Ventilada, 30kg	●	●	●	●
678054	Charola Gabinete 19", Deslizable, 52cm, 1U, Ventilada, 25Kg				
671075	Charola Gabinete 19", Ajustable 70-90cm, 1U, Ventilada, 100kg				
714754	Soporte de monitor VESA para Gabinete/Rack 19", 7U	●	●	●	●
714907	Unidad de extracción de aire 19" con 2 ventiladores y termostato, 1U	●	●	●	●
712668	Unidad de extracción de aire 19" con 3 ventiladores, 1U	●	●	●	●

# Racks para redes de 2 y 4 postes

Para la organización de los dispositivos en tu instalación de red, la línea de racks INTELLINET ofrecen una solución resistente y rentable para los usuarios. Los accesorios harán más sencilla la administración de los dispositivos activos.

## Rack abierto de 19"



19" montaje en rack



Ensamble sencillo sin molestias



Opción de usar ruedas (incluidas)



Unidades marcadas en cada poste



Ganchos organizadores (opción a colocar en postes)

Modelo #	# de postes	U	Altura	Anchura	Profundidad	Envío
714228	2	26	1295 mm	600 mm	603 mm	Flatpack
714235	2	42	2007 mm	600 mm	603 mm	Flatpack
714426	2	48	2273 mm	600 mm	603 mm	Flatpack
714242	4	26	1295 mm	515 mm	559 mm	Flatpack
714259	4	45	2140 mm	515 mm	559 mm	Flatpack
714419	4	48	2273.1 mm	514.5 mm	558.8 mm	Flatpack

Capacidad de carga 300 kg: Modelos 714228, 714235

Capacidad de carga 360 kg: Mod.714242, Mod.714259

## Rack Abierto de 19" para Escritorio

Mejore la organización en la oficina o en el cuarto del servidor colocando el equipo en el escritorio



19" Montaje en escritorio



Ensamble sencillo sin molestias



Unidades de montaje numeradas

Modelo #	Pulgadas	U	Altura	Anchura	Profundidad	Envío
714648	19"	8	416 mm	504 mm	294 mm	Flatpack
714747	19"	12	584 mm	504 mm	294 mm	Flatpack

**RACKS PARA REDES**

		Dos postes			Cuatro postes (Doble)		
		714228	714235	714426	714242	714259	714419
SKU	DESCRIPCIÓN	Rack 19" 2 postes 26U	Rack 19" 2 postes 42U	Rack 19" 2 postes 48U	Rack 19" doble 26U, Ajust. 22-40"	Rack 19" doble 45U, Ajust. 22-40"	Rack 19" doble 48U, Ajust. 22-40"
710954	Charola Rack 19", 2U Ventilada 35.5cm, 15kg	●	●	●	●	●	●
710916	Charola Rack 19", 2U Sólida, 40cm, 25kg	●	●	●	●	●	●
715072	Charola Rack 19", 1U Sólida, 30cm, 25kg	●	●	●	●	●	●
714884	Charola Rack 19", 1U Ventilada, 30cm, 25kg	●	●	●	●	●	●
130066	Charola Rack 19", 1U Ventilada, 40cm, 50kg	●	●	●	●	●	●
712576	Charola Gabinete 19", 1U Fija, 62cm, Ventilada, 100kg				●	●	●
712545	Charola Gabinete 19", 1U Fija, 72cm, Ventilada, 50kg				●	●	●
712552	Charola Gabinete 19", 1U Fija, 92cm, Ventilada, 50kg				●	●	●
712514	Charola Rack 19", 2U Ventilada, 40cm, 25kg				●	●	●
677455	Charola Rack 19", 2U Ventilada, 55cm, 25kg				●	●	●
712613	Charola Gabinete 19", Ajustable 37-60cm, Deslizable, 1U, Ventilada, 35kg				●	●	●
712620	Charola Gabinete 19", Ajustable 60-80cm, Deslizable, 1U, Ventilada, 35kg				●	●	●
714389	Charola Gabinete 19", Ajustable 55-100cm, 1U, Ventilada, 45kg				●	●	●
714709	Charola Gabinete 19", Ajust 60-80cm, Desliz/Rotación 90°, 1U, 30kg				●	●	●
710268	Charola Gabinete 19", Ajustable 60-80cm, Deslizable, 1U, Ventilada, 35kg				●	●	●
601290	Charola Gabinete 19", Ajustable 65-85 cm, 2U, Ventilada, 30kg				●	●	●
714754	Soporte de monitor VESA para Gabinete/Rack 19", 7U	●	●	●	●	●	●



## RACKS PARA ESCRITORIO

SKU	DESCRIPCIÓN	714648	714747
		Rack 19" 8U Escritorio 2 postes	Rack 19" 12U Escritorio 2 postes
715072	Charola Rack 19", 1U Sólida, 30cm, 25kg	●	●
714884	Charola Rack 19", 1U Ventilada, 30cm, 25kg	●	●
169950	Organizador Horizontal 19", 1U Metálico 5cm	●	●
714679	Organizador Horizontal 19", 1U Plástico	●	●
714358	Panel Tapa Ciega, 1U, Sin Herramienta, Plástico	●	●
714310	Panel Tapa Ciega, 1U, Sin Herramienta, Metal	●	●
714341	Panel Tapa Ciega, 2U, Sin Herramienta, Metal	●	●
714372	Panel Tapa Ciega, 3U, Sin Herramienta, Metal	●	●

## 710954. Charola para rack 19", ventilada

**2U**

Altura: 2U

Profundidad:  
35 cmCarga máxima:  
15 Kg

## 710916. Charola para rack 19", sólida

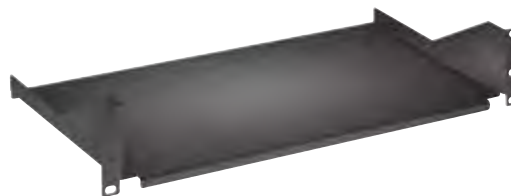
**2U**

Altura: 2U

Profundidad:  
40 cmCarga máxima:  
25 Kg

## 715072. Charola para rack 19", sólida

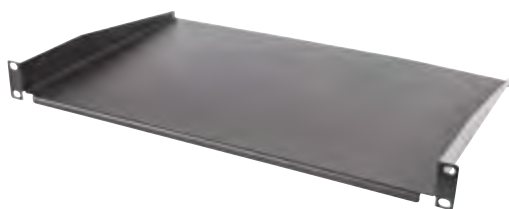
**1U**

Altura: 1U

Profundidad:  
30 cmCarga máxima:  
25 Kg

## 714884. Charola para rack 19", ventilada

**1U**

Altura: 1U

Profundidad:  
30 cmCarga máxima:  
25 Kg

712521. Charola fija para gabinete 19"



1U

Altura: 1U



Profundidad:  
35 cm



Carga máxima:  
50 Kg

712576. Charola fija para gabinete 19"

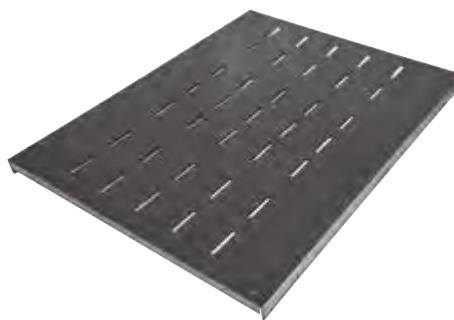

1U

Altura: 1U



Profundidad:  
62 cm



Carga máxima:  
100 Kg

712514. Charola para rack 19", fija



2U

Altura: 2U



Profundidad:  
40 cm



Carga máxima:  
25 Kg

Charola fija para gabinete 19"

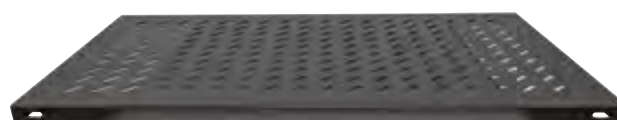

Modelo #	Profundidad	U	Carga
712545	72 cm	1U	50 Kg
712552	92 cm	1U	50 Kg



Compatible con  
gabinetes de red



Ventilada

714709. Charola para gabinete 19", con rotación, ajuste y deslizable

NUEVO

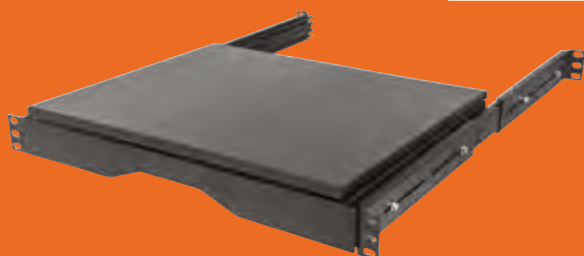

1U

Espacio: 1U

90°

Rotación de  
izquierda a  
derecha



Carga máxima:  
30 Kg



610 mm a 800  
mm profundi-  
dad ajustable

Charola para gabinete 19", ajustable y deslizable

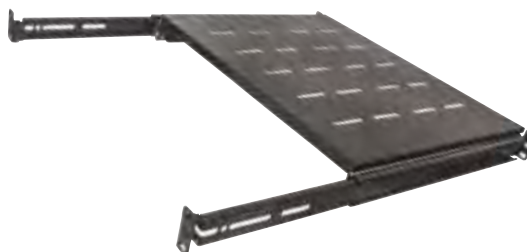

Modelo #	Profundidad	U	Carga
712613	60 cm	1U	35 Kg
712620	80 cm	1U	35 Kg
710268	80 cm	1U	35 Kg

**Charola para rack 19", ventilada**

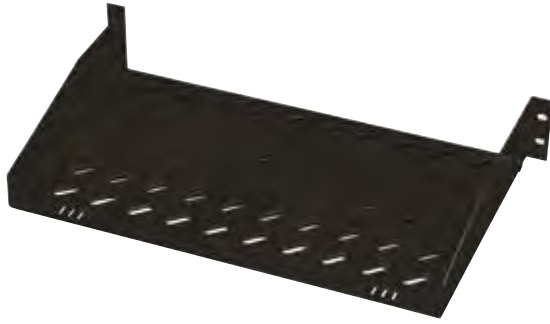

Modelo #	Profundidad	U	Carga
130066	40 cm	1U	50 Kg
677455	55 cm	2U	25 Kg

**678051. Charola fija para gabinete 19"**



<b>1U</b>			
Altura: 1U	Profundidad: 52.5 cm	Fabricadas en acero	Carga máxima: 50 Kg

**714389. Charola ajustable para gabinete 19"**



<b>1U</b>			
Altura: 1U	Carga máxima: 45 Kg	Profundidad: 55-100 cm	Ventilada

**678054. Charola deslizable para gabinete 19"**



<b>1U</b>		
Altura: 1U	Carga máxima: 25 Kg	Profundidad: 52 cm

**671075. Charola ajustable para gabinete 19"**



		
Carga máxima: 100 Kg	Profundidad: 70 - 90 cm	Ventilada

**601290. Charola ajustable para gabinete 19", ventilada**



<b>2U</b>		
2U	Carga máxima: 30 Kg	Profundidad: 65-85 cm

**714907. Unidad de extracción de aire con termostato digital.**



**1U**

Ocupa 1U en rack



19" montaje en rack



Termostato digital



Botón de encendido y apagado

**712668. Unidad de extracción de aire**



3 ventiladores

**1U**

Ocupa 1U en rack



19" montaje en rack

**714754. Soporte para monitor LCD en rack de 19"**



Compatible con monitores de 17" y 19" LCD, LED y pantalla táctil



Ventilado



Fabricado en acero

**714358. Tapa ciega de 19"**



**1U**

Ocupa 1U en rack



No necesita herramientas



Plástico



Para espacio sin usar en gabinetes

**Tapa ciega de 19"**

**714310. 1U**

**714341. 2U**

**714372. 3U**



**714372**

**U**

714310. 1U  
714341. 2U  
714372. 3U



No necesita herramientas



Metal



Para espacio sin usar en gabinetes

**Organizadores horizontales para cable**



**169950. 1U, tapa metálica**

**1U**

1U de alto



5 cm de profundidad



Metal

**168458. 2U, tapa de plástico**

**2U**

2U de alto



10 cm de profundidad



Plástico

**Organizador Horizontal de Cable de 19"**

714679. 1U    714686. 2U



**Organizador Horizontal de Cable de 19"**

714655. 1U    714662. 2U



Cubierta removible



Rieles de doble cara y orificios



Alivio de tensión de cables



Cubierta removible



Rieles de doble cara y orificios



Alivio de tensión de cables



La tuerca M6 presente en nuestros productos **715157, 712194, 711081, 713658 y 710718** ofrece un mejor ajuste y una mayor protección a tus equipos instalados en Racks y Gabinetes.

**715157. Bote con 50 juegos de tuercas enjauladas, tornillos y arandelas, 12-24**

**NUEVO**



Tornillos de cabeza en cruz / Phillips



Color plateado



100 juegos

**Tornillería M6 con tuerca enjaulada**



Modelo #	Piezas	Presentación
712194	20 juegos	Bolsa
711081	50 juegos	Bote
713658	100 juegos	Bote



Tornillos



Tuerca enjaulada



Color plateado

**710718. Tornillería M6, color negro**



· Presentación en bolsa



20 juegos, tuerca y tornillo



Tuerca enjaulada



Compatible con Racks y Gabinetes de redes

# Unidades de Distribución de Energía

## PDU (Power Distribution Units)

Las PDU (unidades de distribución de energía) de Intellinet proporcionan una distribución de energía confiable a través de una sola entrada con múltiples receptáculos de salida. Nuestra gama actual está diseñada para distribuir energía de circuitos eléctricos monofásicos de bajo amperaje.



### 163682. Barra multicontactos de 8 salidas para montaje en rack de 19"

**PRODUCTO DESTACADO**



8 puertos, IEC320 C13 salida de energía con corriente total de 16 A



19" montaje en rack 1.5U



Alarmas personalizables de alerta y sobrecarga



Protección integrada contra sobrecargas y cortocircuitos

### 164603. Barra multicontacto con 16 salidas USB Tipo A para rack de 19" (NEMA 5-15)

**NUEVO**



16 salidas USB Tipo A



2.1 Amperes por módulo



19" montaje en rack



Protección contra sobrecargas



Cable de alimentación de 2 m

### 163651. Unidad de distribución de energía C13 1U de 8 salidas anti-desconexión para montaje en rack de 19"

**NUEVO**



8 puertos anti-desconexión



19" montaje en rack



Cable de alimentación de 2 m

### 713955. Barra multicontactos vertical con 12 salidas para montaje en rack de 19"



Sin protección a sobretensión



Cable de alimentación de 1.6 m



Interruptor neumático sencillo



Para uso en posición vertical



**207102. Barra multicontactos de 7 salidas para montaje en rack de 19"**



19" montaje en rack



Protección de sobrevoltaje



Cable de alimentación de 3 m

**713979. Barra multicontactos con 6 salidas para montaje en 1.5U de rack de 19"**



19" montaje en rack 1.5U



Protección de sobrevoltaje



Cable de alimentación de 3 m



Switch de encendido/apagado

**713948. Barra multicontactos con 6 salidas**



19" montaje en rack



sin protección a sobretensión



Cable de alimentación de 1.6 m



Doble interruptor

**714013. Barra multicontactos con 7 salidas para montaje en 1.5 U de rack de 19"**



19" montaje en rack 1.5U



Protección contra sobretensiones



Cable de alimentación de 3 m

**713993. Barra multicontactos con 8 salidas para montaje en 1U de rack de 19"**



19" montaje en rack 1 U



Protección contra sobrecargas



Cable de alimentación de 3 m



Switch de encendido/apagado

**714075. Barra multicontactos de 15 salidas para montaje en 2U de rack de 19"**



19" montaje en rack



Doble interruptor neumático



Cable de alimentación de 3 m

# CERTIFICACIÓN INTELLINET EN CABLEADO ESTRUCTURADO

Un **Sistema de Cableado Estructurado** es la base angular de las redes de información de tu empresa. Esta columna física, compuesta de cables, conectores, accesorios y estructuras metálicas, serán el pilar del funcionamiento óptimo de tus servicios de voz, video, seguridad e incluso energía. Contar con una **Certificación** en Cableado estructurado, suma beneficios que garantizan el buen funcionamiento de este sistema.



Para ser competitivo en el mundo de instaladores, Intellinet te invita a certificarte y formar parte de su Red de Integradores Certificados, con ello serás acreedor a:

Planes de lealtad · Asesoría en proyectos · Precios especiales · Capacitación · Invitación a eventos  
Garantías extendidas hasta por 25 años en instalaciones con la marca

**¡Certifícate, desarrolla tu potencial y únete a la Red Mundial de Instaladores Certificados!**





**manhattan**<sup>®</sup>  
Life just got easier.<sup>™</sup>

# SOLUCIONES DE AUDIO Y VIDEO

Manhattan te ofrece soluciones completas de audio y video, sin importar si es para el hogar, la oficina, una sala de capacitación o de conferencias, un centro comercial, o cualquier otra aplicación que tengas en mente. En esta sección encontrarás desde soportes para montar una televisión, hacer un video wall, soportes de monitor o de proyector, una variedad muy amplia de cables HDMI, adaptadores, convertidores para conectar de una tecnología a otra, splitters, extensores, switches de video, matrices para conectar varias fuentes a varias pantallas. Lo que quieres, Manhattan lo tiene.

**TABLA DE CARACTERÍSTICAS DE LOS SOPORTES DE TV**

Características		Modelos					
		461719	461702	461245	461238	461412	423625
Para TV, monitor o ambas		TV	TV	TV	TV	TV	TV
Número de pantallas		1	1	1	1	1	1
Tamaño de pantalla recomendado		45" a 70"	45" a 70"	37" a 70"	37" a 70"	37" a 70"	37" a 70"
Brazo	Un brazo						
	Doble brazo						
	Articulación doble						
Montaje	Pared						
	Techo						●
	Móvil			Soporte móvil con ruedas	Soporte móvil con ruedas	Soporte de Trípode	
Planas, curvas o ambas		Plana	Plana	Plana	Plana	Plana	Plana
Material principal							Acero de alta resistencia
Límite de peso				50 kg	50 kg	35 kg	50 kg
Fijo							
Inclinación		-5 a +3°	-5 a 3°	+5 a -12°	+/- 10°	-8° a 0°	0° a -15°
Rotación							
Ajuste de altura				●	●	●	
Ajuste de nivel							
Giro							360°
Total movimiento							
Estándar VESA	75 x 75						
	100 x 100						
	200 x 100						
	200 x 200	●	●	●	●	●	●
	300 x 200						
	300 x 300	●	●	●	●	●	●
	400 x 200	●	●	●	●	●	●
	400 x 300						
	400 x 400	●	●	●	●	●	●
	600 x 400	●	●	●	●	●	●
800 x 400						●	

**461719. Soporte Premium de TV para Video Wall**

**NUEVO**



• SE DESPLIEGA PARA ACCEDER A LA PARTE TRASERA



Pulgadas:  
45" a 70"



Hasta 70 kg



Para pantallas  
planas



Inclinación:  
-5° a 3°

**461702. Soporte de TV para Video Wall**

**NUEVO**



• CON MICROAJUSTES PARA MEJOR ALINEACIÓN



Pulgadas:  
45" a 70"



Hasta 70 kg



Para pantallas  
planas



Inclinación:  
-5° a +3

**461245. Soporte para TV tipo carrito**



• CON RUEDAS  
• ALUMINIO



Pulgadas:  
37" a 70"



Hasta  
50 kg



Con repisa  
removible  
hasta 5 kg



Inclinación: -12 a 5°  
Rotación: Hasta 90°

**461238. Soporte económico para TV tipo carrito**

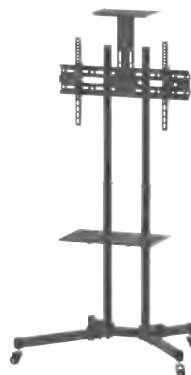

• CON RUEDAS  
• ACERO



Pulgadas:  
37" a 70"



Hasta  
50 kg



Charola hasta  
10 kg



Inclinación: +/- 10°

**461412. Soporte para TV con trípode**



• DE TRÍPODE



Pulgadas:  
37" a 70"



Hasta  
35 kg



Con trípode



Inclinación: -8° a 0°

**423625. Para pantallas de TV**



• PARA TECHO  
• SE EXTIENDE  
DE 105 A 156 CM



Pulgadas:  
37" a 70"



Hasta  
50 kg

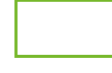

Para pantallas  
planas



Inclinación: 0° a 15°  
vertical  
Rotación: 360°

## TABLA DE CARACTERÍSTICAS DE LOS SOPORTES DE TV

Características		Modelos					
		461221	461290	461283	461337	461351	461214
Para TV, monitor o ambas		TV	TV	TV	TV	TV	TV
Número de pantallas		1	1	1	1	1	1
Tamaño de pantalla recomendado		60" - 100"	37" - 90"	37" - 70"	37" - 70"	37" - 70"	37" - 63"
Brazo	Un brazo			●	●		
	Doble brazo	●	●			●	●
	Articulación doble	●	●		●	●	●
Montaje	Pared	●	●		●	●	●
	Techo						
	Móvil						
Planas, curvas o ambas		Ambas		Plana	Ambas	Ambas	Plana
Material principal		Acero de alta resistencia	Acero de alta resistencia	Acero de alta resistencia	Acero	Acero	Acero de alta resistencia
Límite de peso		80 kg	75 kg	50 kg	35 kg	40 kg	60 kg
Fijo							
Inclinación		-15° a 5°	-15° a 5°	-20° a 10°	+10° a -15°	-15° a 5°	±15°
Rotación							
Ajuste de altura			±3°				
Ajuste de nivel		±3°		±3°	±3°	±3°	±5°
Giro		±45°	±60°	180°	±90°	±60°	120°
Total movimiento		●	●	●	●	●	●
Estándar VESA	75 x 75						
	100 x 100						
	200 x 100						
	200 x 200	●	●	●	●	●	●
	300 x 200						
	300 x 300	●	●	●	●	●	●
	400 x 200	●	●	●	●	●	●
	400 x 300						
	400 x 400	●	●	●	●	●	●
	600 x 400	●	●	●	●	●	●
	800 x 400	●	●				●
900x600	●						

**461221. Soporte de montaje de pared para pantallas grandes**

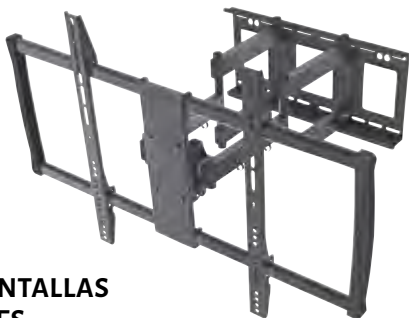

• PARA LAS PANTALLAS MÁS GRANDES



Pulgadas: 60" a 100"



Hasta 80 kg



Para pantallas planas o curvas



Inclinación: -15° a 5°  
Giro: ±45°  
Ajuste de nivel: ±3°

**461290. Soporte con movimiento completo para pantallas grandes**



• PARA PANTALLAS HASTA 90"



Pulgadas: 37" a 90"



Hasta 75 kg



Para pantallas planas o curvas



Inclinación: -20° a +10°  
Giro: 180°

**461283. Soporte de TV articulado para montaje en pared**



• SE EXTIENDE DE 6.2 A 47.5 CM



Pulgadas: 37" a 70"



Hasta 50 kg



Para pantallas planas o curvas



Inclinación: -20° a +10°  
Giro: 180°

**461337. Soporte para TV con montaje para pared**

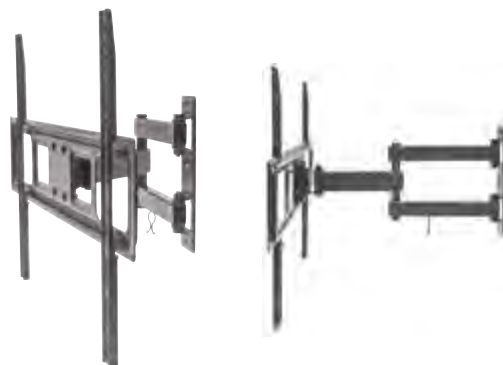

• SE EXTIENDE HASTA 24.7 CM



Pulgadas: 37" a 70"



Hasta 35 kg



Para pantallas planas o curvas



Inclinación: +10° a -15°  
Rotación: ±90°  
Ajuste de nivel: ±3°

**461351. Soporte para pared universal LCD de total movimiento**



• SE EXTIENDE HASTA 46.4 CM



Pulgadas: 37" a 70"



Hasta 40 kg



Para pantallas planas o curvas



Inclinación: -15° a 5°  
Rotación: ±60°  
Ajuste de nivel: ±3°

**461214. Soporte de montaje en esquinas**



• PARA ESQUINAS



Pulgadas: 37" a 63"



Hasta 60 kg

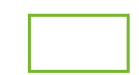

Para pantallas planas



Inclinación: ±15°  
Giro: 120°  
Ajuste de nivel: ±5°

## TABLA DE CARACTERÍSTICAS DE LOS SOPORTES DE TV

Características		Modelos					
		461306	461344	461313	461320	423830	461481
Para TV, monitor o ambas		TV	TV	TV	TV	TV	TV
Número de pantallas		1	1	1	1	1	1
Tamaño de pantalla recomendado		32" - 55"	32" - 55"	32" - 55"	32" - 55"	37" - 85"	37" - 80"
Brazo	Un brazo				●		
	Doble brazo	●	●	●			
	Articulación doble	●	●	●	●		
Montaje	Pared	●	●	●	●	●	●
	Techo						
	Móvil						
Planas, curvas o ambas		Ambas	Ambas	Ambas	Ambas	Plana	Plana
Material principal		Aluminio	Acero	Aluminio	Acero	Acero de alta resistencia	Acero
Límite de peso		50 kg	40 kg	30 kg	35 kg	75 kg	80 kg
Fijo							
Inclinación		-15° a 5°	-15° a 5°	-15° a 15°	+10° a -15°	±10°	-10° a 5°
Rotación							
Ajuste de altura							
Ajuste de nivel		±2.5°	±3°	±5°	±3°		
Ajuste de nivel después de instalado							●
Giro		±60°	±60°	±80°	±90°		
Total movimiento		●	●	●	●		
Bajo perfil				●			
Estándar VESA	75 x 75						
	100 x 100						
	200 x 100						
	200 x 200	●	●		●	●	●
	300 x 200						
	300 x 300	●	●	●	●	●	●
	400 x 200	●	●	●	●	●	●
	400 x 300						
	400 x 400	●	●	●	●	●	●
	600 x 400					●	●
800 x 400					●		

**461306. Soporte para TV con montaje para pared**



- DE ALUMINIO
- SE EXTIENDE HASTA 51.8 CM



Pulgadas:  
32" a 55"



Hasta  
50 kg



Para pantallas  
planas o curvas



Inclinación: -15° a 5°  
Rotación: ±60°  
Ajuste de nivel: ±2.5°

**461344. Soporte para pared de total movimiento**

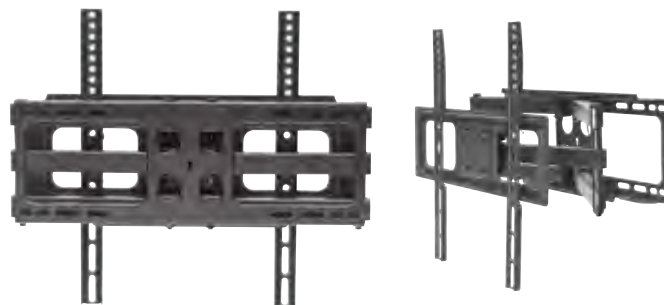

- SE EXTIENDE DE 5.3 A 46.4 CM



Pulgadas:  
32" a 55"



Hasta  
40 kg



Para pantallas  
planas o curvas



Inclinación: -15° a 5°  
Rotación: ±60°  
Ajuste de nivel: ±3°

**461313. Soporte para TV con montaje para pared**

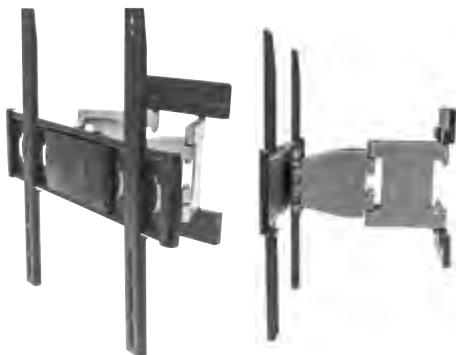

- DE ALUMINIO
- SE EXTIENDE HASTA 26.8 CM



Pulgadas:  
32" a 55"



Hasta  
30 kg



Para pantallas  
planas o curvas



Inclinación: -15° a 15°  
Rotación: 80°  
Ajuste de nivel: ±5°

**461320. Soporte para TV con montaje para pared**

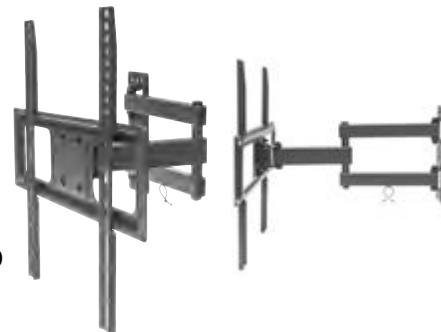

- TOTAL MOVIMIENTO
- SE EXTIENDE HASTA 42.7 CM



Pulgadas:  
37" a 55"



Hasta  
35 kg



Para pantallas  
planas o curvas



Inclinación:  
+10° a -15°  
Rotación: ±90°  
Ajuste de nivel: ±3°

**423830. Soporte para TV con montaje para pared con ajuste vertical**



- CON BURBUJA DE NIVEL INTEGRADA



Pulgadas:  
37" a 85"



Hasta  
75 kg

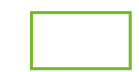

Para pantallas  
planas



Inclinación: Ajuste  
vertical de ±10°

**461481. Soporte para TV con montaje para pared**



- AJUSTA ALINEACIÓN DESPUÉS DE INSTALADO



Pulgadas:  
37" a 80"



Hasta  
80 kg

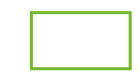

Para pantallas  
planas



Inclinación:  
-10° a +5°

## TABLA DE CARACTERÍSTICAS DE LOS SOPORTES DE TV

Características		Modelos					
		461467	424752	461450	461474	460941	460934
Para TV, monitor o ambas		TV	TV	TV	TV	TV	TV
Número de pantallas		1	1	1	1	1	1
Tamaño de pantalla recomendado		37" - 70"	37" - 70"	32" - 55"	32" - 55"	32" - 55"	32" - 55"
Brazo	Un brazo						
	Doble brazo						
	Articulación doble						
Montaje	Pared	●	●	●	●	●	●
	Techo						
	Móvil						
Planas, curvas o ambas		Plana	Plana	Plana	Plana	Plana	Plana
Material principal		Acero	Acero de alta resistencia	Acero	Acero	Acero	Acero
Límite de peso		35 kg	75 kg	35 kg	80 kg	35 kg	40 kg
Fijo							●
Inclinación		-12° a 12°	0° a -10°	-12° a +12°	-10° a 5°	0° a -14°	
Rotación							
Ajuste de altura							
Ajuste de nivel							
Giro							
Bajo perfil							●
Estándar VESA	75 x 75						
	100 x 100						
	200 x 100						
	200 x 200	●	●	●	●	●	●
	300 x 200	●		●			
	300 x 300	●	●	●	●	●	●
	400 x 200	●	●	●	●	●	●
	400 x 300	●		●			
	400 x 400	●	●	●	●	●	●
	600 x 400	●	●				
800 x 400							



**461467. Soporte para TV con montaje para pared**



• CON ESPACIO PARA ALMACENAMIENTO



Pulgadas:  
37" a 70"



Hasta  
35 kg



Para pantallas  
planas



Inclinación:  
-12° a +12°

**424752. Soporte para pared para TV planas**



• CON NIVEL DE BURBUJA INTEGRADO



Pulgadas:  
37" a 70"



Hasta  
75 kg



Para pantallas  
planas



Ajuste vertical:  
0° a -10°

**461450. Soporte para TV con montaje para pared y área de almacenamiento**

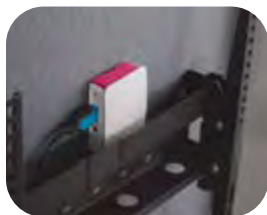

• ESPACIO DE ALMACENAMIENTO EN EL SOPORTE



Pulgadas:  
32" a 55"



Hasta  
35 kg

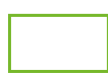

Para pantallas  
planas



Inclinación:  
-12° a +12°

**461474. Soporte para TV con montaje para pared**

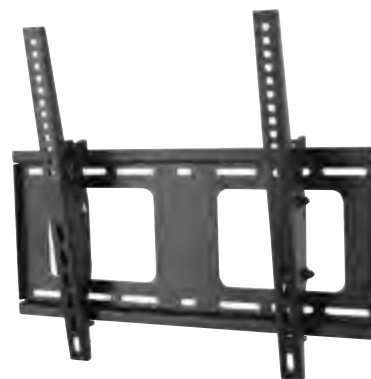

• SE AJUSTA DESPUÉS DE INSTALADA



Pulgadas:  
32" a 55"



Hasta  
80 kg



Para pantallas  
planas



Inclinación:  
-10° a +5°

**◆ 460941. Soporte para TV con ajuste vertical**



• ECONÓMICO



Pulgadas:  
32" a 55"



Hasta  
35 kg

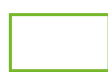

Para pantallas  
planas



Ajuste vertical  
0° a -14°

**◆ 460934. Soporte de bajo perfil para TV**



• FIJO



Pulgadas: 32" a 55"



Hasta 40 kg



Para pantallas planas

**461641. Soporte de pared para TV, con pistón a gas**

**PRÓXIMAMENTE**



• CON PISTÓN DE GAS



Pulgadas:  
21" a 60"



Hasta 30 kg



Para monitores  
planos y curvos



Inclinación:  $\pm 10^\circ$   
Giro:  $\pm 90^\circ$   
Rotación:  $\pm 180^\circ$

**461399. Soporte para TV con montaje para pared**



• DE ACERO  
• SE EXTIENDE HASTA 19 CM



Pulgadas:  
13" a 42"



Hasta 20 kg



Para pantallas  
planas



Inclinación:  $+5^\circ$  a  $-12^\circ$   
Rotación:  $\pm 90^\circ$   
Ajuste de nivel:  $\pm 3^\circ$

**461405. Soporte para TV con montaje para pared**



• DE ACERO  
• SE EXTIENDE HASTA 27.3 CM



Pulgadas:  
13" a 42"



Hasta 20 kg

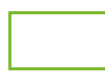

Para pantallas  
planas



Inclinación:  $5^\circ$  a  $-12^\circ$   
Rotación:  $\pm 45^\circ$   
Ajuste de nivel:  $\pm 3^\circ$

**423755. Soporte para TV con montaje para pared**



• DE ALUMINIO  
• SE EXTIENDE HASTA 40 CM



Pulgadas:  
23" a 42"



Hasta 20 kg



Para pantallas  
planas



Ajuste vertical:  $\pm 15^\circ$   
Rotación:  $\pm 180^\circ$

**423700. Soporte para monitor/TV con montaje para pared con ajuste articulado**



• DE ALUMINIO  
• SE EXTIENDE HASTA 24.8 CM



Pulgadas:  
13" a 27"



Hasta 15 kg



Para monitores  
planos



Ajuste vertical:  $\pm 15^\circ$   
Rotación:  $\pm 180^\circ$

**423670. Soporte de pared para monitor/TV**



• DE ALUMINIO  
• SE EXTIENDE HASTA 40.8 CM



Pulgadas:  
13" a 27"



Hasta 15 kg



Para monitores  
planos



Ajuste vertical:  $\pm 15^\circ$   
Rotación:  $\pm 180^\circ$

**460965. Soporte para pared universal**



- DE ALUMINIO
- SE EXTIENDE HASTA 19.5 CM



Pulgadas:  
13" a 27"



Hasta  
15 kg

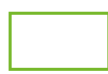

Para monitores  
planos



Inclinación:  $\pm 45^\circ$   
Rotación:  $\pm 90^\circ$

**460958. Soporte para TV con montaje para pared**



- DE ALUMINIO
- SE EXTIENDE HASTA 38.2 CM



Pulgadas:  
13" a 27"



Hasta  
15 kg

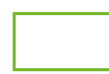

Para pantallas  
planas



Ajuste vertical:  $\pm 70^\circ$   
Rotación:  $\pm 90^\circ$

**461382. Soporte de pared para monitor/TV**



- USO LIGERO
- SE EXTIENDE HASTA 35.4 CM



Pulgadas:  
13" a 27"



Hasta  
15 kg



Para monitores  
planos



Inclinación:  $5^\circ$  a  $-12^\circ$   
Rotación:  $\pm 90^\circ$   
Ajuste de nivel:  $\pm 3^\circ$

**461269. Soporte ergonómico para trabajar de pie o sentado**



Pulgadas:  
Hasta 30"



Hasta  
7.5 kg



Para  
1 monitor



Inclinación:  $\pm 25^\circ$   
Giratorio:  $\pm 25^\circ$   
Pivote:  $\pm 90^\circ$

**461443. Soporte ergonómico para trabajar de pie o sentado**



Pulgadas:  
13" a 27"



Hasta 8 kg  
por brazo



Para  
2 monitores



Inclinación:  $\pm 15^\circ$   
Giro:  $\pm 90^\circ$   
Rotación:  $\pm 180^\circ$

**461429. Soporte sobre escritorio para 1 monitor**



- DOS PUERTOS USB 3.0.
- CON PISTÓN DE GAS



Pulgadas:  
13" a 27"



Hasta  
6 kg



Para  
1 monitor



Inclinación:  $\pm 90^\circ$   
Giro:  $\pm 25^\circ$   
Rotación:  $\pm 180^\circ$

**461597. Soporte para dos monitores, con pistón a gas**

**NUEVO**



• CON PISTÓN DE GAS



Pulgadas:  
17" a 32"



Hasta 8 kg  
cada brazo



Para 2 monitores  
planos o curvos



Inclinación:  $\pm 35^\circ$   
Giro:  $\pm 90^\circ$   
Rotación:  $\pm 180^\circ$

**461627. Soporte de pared para dos monitores, con pistones a gas**

**NUEVO**



• DE PARED  
• CON PISTÓN DE GAS



Pulgadas:  
17" a 32"



Hasta 8 kg  
cada brazo



Para 2 monitores  
planos y curvos



Inclinación:  $\pm 35^\circ$   
Giro:  $\pm 90^\circ$   
Rotación:  $\pm 180^\circ$

**461573. Soporte de escritorio para monitor**



• CON PISTÓN DE GAS



Pulgadas:  
17" a 32"



Hasta  
8 kg



Para  
1 monitor



Inclinación:  $\pm 35^\circ$   
Giro:  $\pm 90^\circ$   
Rotación:  $\pm 180^\circ$

**461580. Soporte de escritorio para monitor**



• CON PISTÓN DE GAS



Pulgadas:  
17" a 32"



Hasta  
8 kg



Para  
1 monitor



Inclinación:  $\pm 35^\circ$   
Giro:  $\pm 90^\circ$   
Rotación:  $\pm 180^\circ$

**461610. Soporte de pared para monitor**



• DE PARED  
• CON PISTÓN DE GAS



Pulgadas:  
17" a 32"



Hasta  
8 kg



Para  
1 monitor



Inclinación:  $\pm 35^\circ$   
Giro:  $\pm 90^\circ$   
Rotación:  $\pm 180^\circ$

**461603. Soporte de pared para monitor con pistón a gas**

**NUEVO**

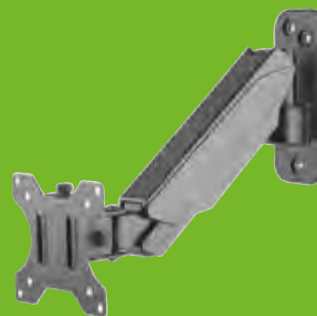

• DE PARED  
• CON PISTÓN DE GAS



Pulgadas:  
17" a 32"



Hasta  
8 kg



Para  
1 monitor



Inclinación:  $\pm 35^\circ$   
Giro:  $\pm 90^\circ$   
Rotación:  $\pm 180^\circ$

**461566. Soporte de escritorio para 4 monitores con brazos de doble articulación**

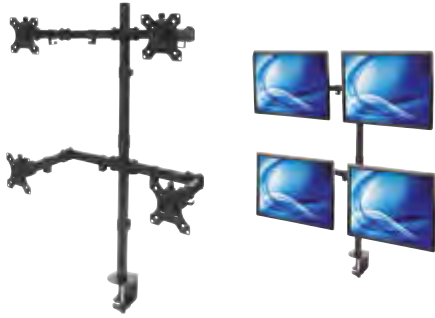

Pulgadas:  
13" a 32"



Hasta 8 kg  
cada brazo



Para 4  
monitores



Inclinación:  $\pm 45^\circ$   
Rotación:  $\pm 180^\circ$

**461658. Soporte de escritorio para 3 monitores con brazos de doble articulación**



Pulgadas:  
13" a 27"



Hasta 7 kg  
cada brazo



Para 3  
monitores



Inclinación:  $\pm 45^\circ$   
Rotación:  $\pm 180^\circ$

**461528. Soporte de escritorio con dos brazos de doble articulación**



Pulgadas:  
13" a 32"



Hasta 8 kg  
cada brazo



Para 2  
monitores



Inclinación:  $\pm 45^\circ$   
Rotación:  $\pm 180^\circ$

**461559. Soporte sobre escritorio para 2 monitores con brazos de doble articulación**



Pulgadas:  
13" a 32"



Hasta  
8 kg



Para  
2 monitores



Inclinación:  $\pm 45^\circ$   
Rotación:  $\pm 180^\circ$

**420808. Soporte de escritorio con dos brazos de doble articulación**



Pulgadas:  
13" a 24"



Hasta 6 kg  
cada brazo



Para 2  
monitores



Movimientos separados  
de  $180^\circ$  vertical  
y  $180^\circ$  de rotación

**461498. Soporte VESA universal para laptop**

**NUEVO**

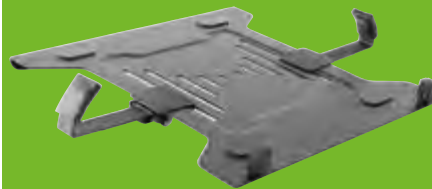

• SE AJUSTA A LA MAYORÍA DE LOS POSTES DE SOPORTES DE MONITOR



Las ventilaciones en la base permiten la disipación del calor de la laptop y permiten una operación fresca



Ganchos laterales retráctiles para ajustarse a cualquier laptop

**461542. Soporte de escritorio con brazo articulado**



Pulgadas:  
13" a 32"



Hasta  
8 kg



Para 1 monitor



Inclinación:  $\pm 45^\circ$   
Rotación:  $360^\circ$

**423786. Soporte de escritorio con brazo de doble articulación**



Pulgadas:  
13" a 27"



Hasta  
15 kg



Para 1 monitor



Ajuste vertical:  $\pm 15^\circ$   
Rotación:  $180^\circ$

**422840. Soporte fijo de pared para un monitor**



Pulgadas:  
13" a 22"



Hasta  
15 kg



Para  
1 monitor



Ajuste fijo

**432351. Soporte articulado de pared para un monitor**



Pulgadas:  
13" a 22"



Hasta 12 kg



Para  
1 monitor



Inclinación:  $\pm 90^\circ$   
Giro:  $\pm 90^\circ$   
Rotación:  $360^\circ$

**461504. Soporte de teléfono, magnético**



Para teléfono celular



Para colocarse en la  
ventila de los autos



Rotación:  $360^\circ$

**406000. Soporte para tablet a la cabecera del auto**



Pulgadas:  
De 8.9" a 10.4"



Para tablet



Giro:  $360^\circ$

**461191. Soporte para proyector de techo o pared**

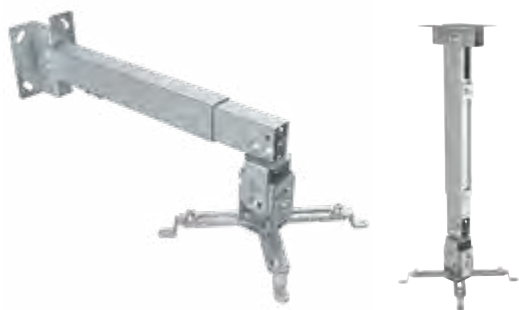

Hasta  
20 kg



Ajuste de altura:  
43 a 65 cm



Inclinación: -15° a 15°  
Giro: -8° a 8°

**424820. Soporte para montaje de proyector en techo**



• PARA PROYECTOR



Hasta  
10 kg



Ajuste de altura:  
13 a 106 cm



Inclinación: ±10°  
Giro: 360°

**424851. Soporte para montaje de proyector en techo**



• PARA PROYECTOR



Hasta  
20 kg



Extensión  
de la barra:  
57.5 a 82.5 cm



Inclinación: ±20°  
Giro: 360°

**461153. Soporte de proyector en techo**



• PARA PROYECTOR



Hasta  
25 kg



Inclinación: -20° a 20°  
Giro: -20° a 20°  
Rotación: 360°

**461184. Soporte de proyector en techo**



• PARA PROYECTOR



Hasta  
13.5 kg



Inclinación: -15° a 15°  
Giro: -15° a 15°  
Rotación: 360°



# Cajas de conexión

La solución ideal para conectar todos tus dispositivos de forma ordenada y en un solo lugar.

Recomendado para espacios como:

- Salas de juntas
- Salas de cómputo
- Salones de clases
- Oficinas

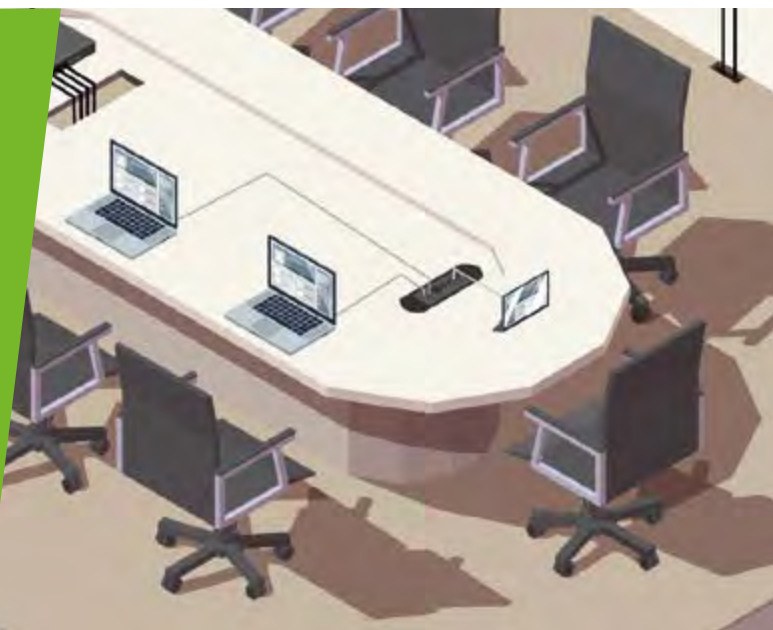

164863. Caja de conexión para mesa con enchufe, US

**NUEVO**



2 conexiones estándar, 110-220V



2 entradas USB-A, 5V/2.1A



2 entradas RJ45



1 entrada plug 3.5 mm



1 entrada HDMI, 1080p



1 entrada VGA, 1080p

164856. Caja de conexión

**NUEVO**



2 conexiones estándar, 110-220V



2 entradas USB-A, 5V/2.1A



2 entradas RJ45



1 entrada HDMI, 1080p



1 entrada VGA, 1080p

164832. Caja de conexión para mesa con enchufe, US

**NUEVO**



2 conexiones estándar, 110-220V



2 entradas USB-A, 5V/2.1A



1 entrada HDMI, 1080p



1 entrada VGA, 1080p

164849. Caja de conexión para mesa con enchufe, US

**NUEVO**



4 conexiones estándar, 110-220V



2 entradas USB-A, 5V/2.1A





# Cables HDMI

La tecnología HDMI es la interfaz digital de video, audio y datos líder para conectar pantallas de altay ultra alta definición a una amplia gama de dispositivos. Los cables HDMI transmiten simultáneamente video no comprimido, así como audio comprimido y sin comprimir.



## 8K ULTRA ALTA VELOCIDAD

Cable HDMI de ultra alta velocidad con ethernet, blindado

**NUEVOS**



Modelos	Longitud	Empaque	Conectores
<b>354080</b>	2.0 m	Bolsa	Macho - Macho
<b>354332</b>	3.0 m	Bolsa	Macho - Macho
8K@60Hz y 4K@120Hz UHD	Ancho de banda: 48 Gbps, 3D, HEC, eARC	Completa compatibilidad con productos HDMI 2.1, admite formatos de audio más avanzados	

## CABLE DE FIBRA ÓPTICA, ACTIVO

Cable HDMI compatible con estándares 2.0 o superiores, clasificación Plénium (CMP).

**NUEVOS**



Modelos	Longitud	Empaque	Conectores
<b>355414</b>	10.0 m	Caja	Macho - Macho
<b>355438</b>	30.0 m	Caja	Macho - Macho
<b>355445</b>	50.0 m	Caja	Macho - Macho
4K@60Hz UHD	Ancho de banda: 18 Gbps, 3D, ARC	Admite formatos de audio Dolby, Dolby Atmos, DTS y PCM	

## PREMIUM

Cable HDMI de alta velocidad con ethernet, blindado

**PRÓXIMAMENTE**



Modelos	Longitud	Empaque	Conectores
<b>354837</b>	1.0 m	Bolsa	Macho - Macho
<b>355346</b>	1.8 m	Bolsa	Macho - Macho
<b>355353</b>	3.0 m	Bolsa	Macho - Macho
<b>355360</b>	5.0 m	Bolsa	Macho - Macho
<b>355377</b>	9.0 m	Bolsa	Macho - Macho
4K@60Hz UHD	Ancho de banda: 18 Gbps, 3D, HEC, ARC		

## INTRAMUROS

Cable HDMI de alta velocidad con ethernet, blindado



Modelos	Longitud	Empaque	Conectores
<b>353922</b>	1.0 m	Bolsa	Macho - Macho
<b>353939</b>	2.0 m	Bolsa	Macho - Macho
<b>353946</b>	3.0 m	Bolsa	Macho - Macho
<b>353953</b>	5.0 m	Bolsa	Macho - Macho
<b>353960</b>	8.0 m	Bolsa	Macho - Macho
<b>353977</b>	10.0 m	Bolsa	Macho - Macho
4K@60Hz UHD	Ancho de banda: 18 Gbps, 3D (1080p), HEC, ARC		

**ULTRADELGADOS**

**Cable HDMI de alta velocidad con ethernet, blindado**



Modelos	Longitud	Empaque	Conectores
<b>394406</b>	0.5 m	Blíster	Macho - Macho
<b>394352</b>	1.0 m	Blíster	Macho - Macho
<b>394369</b>	1.8 m	Blíster	Macho - Macho
<b>394376</b>	3.0 m	Blíster	Macho - Macho
<b>394383</b>	4.5 m	Blíster	Macho - Macho
4K@60Hz UHD	Ancho de banda: 18 Gbps, 3D (1080p), HEC, ARC		

**RECUBRIMIENTO TEXTIL**

**Cable HDMI de alta velocidad con ethernet, blindado**



Modelos	Longitud	Empaque	Conectores
<b>354813</b>	3.0 m, negro/azul	Bolsa	Macho - Macho
<b>354783</b>	3.0 m, negro/blanco	Bolsa	Macho - Macho
<b>354790</b>	5.0 m, negro/ blanco	Bolsa	Macho - Macho
4K@60Hz UHD	Ancho de banda: 18 Gbps, 3D, HEC, ARC		

**Cable HDMI de alta velocidad, blindado**



Modelos	Longitud	Empaque	Conectores
<b>308816</b>	1.0 m	Bolsa	Macho - Macho
<b>355308</b>	1.5 m	Bolsa	Macho - Macho
4K@30Hz	Ancho de banda 10.2 Gbps, 3D (1080p), ARC		

**PLANOS**

**Cable HDMI de alta velocidad con ethernet, blindado**



Modelos	Longitud	Empaque	Conectores
<b>394390</b>	0.5 m	Blíster	Macho - Macho
<b>391474</b>	1.0 m	Blíster	Macho - Macho
<b>391498</b>	3.0 m	Blíster	Macho - Macho
<b>391504</b>	5.0 m	Manga de cartón	Macho - Macho
<b>391542</b>	7.5 m	Manga de cartón	Macho - Macho
<b>391559</b>	10.0 m	Manga de cartón	Macho - Macho
4K@60Hz UHD	Ancho de banda: 18 Gbps, 3D (1080p), HEC, ARC		

**Cable HDMI de alta velocidad con ethernet, blindado**



Modelos	Longitud	Empaque	Conectores
<b>323215</b>	2.0 m	Bolsa	Macho - Macho
<b>393751</b>	2.0 m	Blíster	Macho - Macho
<b>323222</b>	3.0 m	Bolsa	Macho - Macho
<b>323239</b>	5.0 m	Bolsa	Macho - Macho
<b>353274</b>	7.5 m	Bolsa	Macho - Macho
<b>323246</b>	10.0 m	Bolsa	Macho - Macho
<b>323260</b>	15.0 m	Bolsa	Macho - Macho
4K@30Hz, UHD	Ancho de banda 10.2 Gbps, 3D (1080p), HEC, ARC		

**EXTENSIÓN**

**Cable HDMI de alta velocidad con ethernet, blindado**



Modelos	Longitud	Empaque	Conectores
<b>354356</b>	0.2 m	Bolsa	Macho - Hembra
<b>354363</b>	1.0 m	Bolsa	Macho - Hembra
<b>354370</b>	1.8 m	Bolsa	Macho - Hembra
4K@30Hz	Ancho de banda 10.2 Gbps, 3D (1080p), HEC, ARC		



**MICRO HDMI**

**Cable HDMI de Alta Velocidad con Ethernet, blindado**



Modelos	Longitud	Empaque	Conectores
<b>324427</b>	2.0 m	Bolsa	Macho - Micro Macho
4K@30Hz	Ancho de banda: 10.2 Gbps, 3D (1080p), HEC, ARC		

**MINI HDMI**

**Cable HDMI de Alta Velocidad, blindado**



Modelos	Longitud	Empaque	Conectores
<b>304955</b>	1.8 m	Bolsa	Macho - Mini Macho
4K@30Hz UHD	Ancho de banda 10.2 Gbps, 3D (1080p)		

**ECONÓMICO**

**Cable HDMI de Alta Velocidad, blindado**



Modelos	Longitud	Empaque	Conectores
◆ <b>306119</b>	1.8 m	Bolsa	Macho - Macho
◆ <b>306126</b>	3.0 m	Bolsa	Macho - Macho
◆ <b>306133</b>	5.0 m	Bolsa	Macho - Macho
◆ <b>308434</b>	15.0 m	Bolsa	Macho - Macho
4K@30Hz. admite resoluciones mayores a 1080p	Ancho de banda: 10.2 Gbps, 3D (1080p)		

**ECONÓMICO**

**Cable HDMI de Alta Velocidad, blindado**



Modelos	Longitud	Empaque	Conectores
◆ <b>308441</b>	7.5 m	Bolsa	Macho - Macho
◆ <b>322539</b>	10.0 m	Bolsa	Macho - Macho
<b>308458</b>	22.5 m	Bolsa	Macho - Macho
1080p	Ancho de banda: 10.2 Gbps		

**353441. Adaptador HDMI, hembra a micro**



Resolución:  
4K



Contactos con  
baño de oro



Ancho de banda:  
10.2 Gbps

**353489. Adaptador HDMI, macho a hembra**



Resolución:  
4K



Contactos con  
baño de oro



Ancho de banda:  
10.2 Gbps



Ángulo izquierdo  
de 90°

**353496. Adaptador HDMI, macho a hembra**



Resolución:  
4K



Contactos con  
baño de oro



Ancho de banda:  
10.2 Gbps



Ángulo derecho  
de 90°

**353502. Adaptador HDMI H-M ángulo abajo 90°**



Resolución:  
4K



Contactos con  
chapa de oro



Ancho de banda:  
10.2 Gbps



Ángulo de 90°  
hacia abajo

**353519. Adaptador HDMI H-M ángulo arriba 90°**



Resolución:  
4K



Contactos con  
chapa de oro



Ancho de banda:  
10.2 Gbps



Ángulo de 90°  
hacia arriba

**353472. Cople HDMI hembra a hembra ángulo 90°**



Resolución:  
4K



Contactos con  
chapa de oro



Ancho de banda:  
10.2 Gbps



Conexión  
a 90°

**◆ 353465. Acoplador HDMI**



Resolución:  
4K



Contactos con  
chapa de oro



Ancho de banda:  
10.2 Gbps

# Cables SVGA

VGA y SVGA (Video Graphics Array / Super Video Graphics Array). Es un formato también conocido como D-Sub, DB15 o HD15. Los cables SVGA tienen mejor calidad de señal en distancias largas. El VGA tiene resolución de 640 x 840 píxeles, mientras que el SVGA llega hasta 1024 x 768 píxeles.



## SVGA



SVGA			
Modelos	Longitud	Empaque	Conectores
◆ 311731	1.8 m	Bolsa	Macho - Macho
◆ 311748	3.0 m	Bolsa	Macho - Macho
◆ 312721	4.5 m	Bolsa	Macho - Macho
◆ 372978	7.5 m	Bolsa	Macho - Macho
◆ 312776	9.0 m	Bolsa	Macho - Macho
◆ 371377	11.0 m	Bolsa	Macho - Macho
◆ 313629	15.0 m	Bolsa	Macho - Macho
◆ 335607	20.0 m	Bolsa	Macho - Macho
◆ 337342	30.0 m	Bolsa	Macho - Macho

## SVGA - EXTENSIÓN



SVGA			
Modelos	Longitud	Empaque	Conectores
◆ 309011	1.8 m	Bolsa	Macho - Hembra
313599	3.0 m	Bolsa	Macho - Hembra
310345	4.5 m	Bolsa	Macho - Hembra
327015	7.5 m	Bolsa	Macho - Hembra
313612	15.0 m	Bolsa	Macho - Hembra
328746	30.0 m	Bolsa	Macho - Hembra

## SVGA CON CONECTOR DE AUDIO



SVGA con conector de audio 3.5 mm			
Modelos	Longitud	Empaque	Conectores
324267	1.8 m	Bolsa	Macho - Hembra
324359	10.0 m	Bolsa	Macho - Hembra
326681	20.0 m	Bolsa	Macho - Hembra
326711	30.0 m	Bolsa	Macho - Hembra

## SVGA ECONÓMICO



SVGA económico			
Modelos	Longitud	Empaque	Conectores
◆ 371315	1.8 m	Bolsa	Macho - Macho
371568	11.0 m	Bolsa	Macho - Macho

**SVGA CABLE "Y"**



**SVGA cable "Y"**

Modelos	Longitud	Empaque	Conectores
◆ 328302	15 cm	Bolsa	Macho - 2x Hembra

**200462. Adaptador cambiador de género Mini VGA**



Blindado para reducir la interferencia EMI



Con baño de níquel

**Cable DisplayPort a HDMI 1080p**

**NUEVOS**



**Cable DisplayPort a HDMI 1080p**

Modelos	Longitud	Empaque	Conectores
152662	1.0 m	Bolsa	Macho - Macho
152679	1.8 m	Bolsa	Macho - Macho
153188	3.0 m	Bolsa	Macho - Macho

**Cable DisplayPort a HDMI 4K**

**NUEVOS**



**Cable DisplayPort a HDMI 4k@60Hz**

Modelos	Longitud	Empaque	Conectores
153195	1.0 m	Bolsa	Macho - Macho
153201	1.8 m	Bolsa	Macho - Macho
153218	3.0 m	Bolsa	Macho - Macho

**Cable Mini DisplayPort a HDMI 1080p**

**NUEVOS**



**Cable Mini DisplayPort a HDMI 1080p**

Modelos	Longitud	Empaque	Conectores
153225	1.0 m	Bolsa	Macho - Macho
153232	1.8 m	Bolsa	Macho - Macho
153249	3.0 m	Bolsa	Macho - Macho

**Cable Mini DisplayPort a HDMI 4k@60Hz**

**NUEVOS**



**Cable Mini DisplayPort a HDMI 4k@60Hz**

Modelos	Longitud	Empaque	Conectores
153270	1.0 m	Bolsa	Macho - Macho
153287	1.8 m	Bolsa	Macho - Macho
153294	3.0 m	Bolsa	Macho - Macho

Cables DisplayPort y Mini DisplayPort

ÚLTIMAS PIEZAS



Modelos	Longitud	Empaque	Conectores
<b>306935</b>	1.0 m	Bolsa	DP Macho - DP Macho
<b>307116</b>	2.0 m	Bolsa	DP Macho - DP Macho
<b>307093</b>	3.0 m	Bolsa	DP Macho - DP Macho



Modelos	Longitud	Empaque	Conectores
<b>324724</b>	1.0 m	Bolsa	Mini DP Macho - DP Macho
<b>324748</b>	2.0 m	Bolsa	Mini DP Macho - DP Macho
<b>324830</b>	3.0 m	Bolsa	Mini DP Macho - DP Macho



Modelos	Longitud	Empaque	Conectores
<b>324557</b>	1.0 m	Bolsa	Mini DP Macho - Mini DP Macho
<b>324632</b>	2.0 m	Bolsa	Mini DP Macho - Mini DP Macho



Modelo	Longitud	Empaque	Conectores
<b>152150</b>	1.8 m	Bolsa	Mini DP 1.2a Macho - DVI-D 24+1 Macho



Modelo	Longitud	Empaque	Conectores
<b>152167</b>	1.8 m	Bolsa	Mini DP 1.2a Macho - VGA Macho

**152648. Convertidor de HDMI a DisplayPort 4K**



Ancho de banda:  
10.2Gbps



Conecta una fuente  
HDMI a una pantalla  
DisplayPort



Resoluciones:  
4K@30Hz UHD,  
color intenso

**Adaptadores y Convertidores DisplayPort**

**Adaptador DisplayPort a HDMI Pasivo**

Modelo	Empaque	Conexión	Resolución
<b>151993</b>	Bolsa	DP Macho - HDMI Hembra	1080p, Pasivo



**Adaptador DisplayPort 4K, 2 en 1**

Modelo	Longitud	Empaque	Conexión	Resolución
<b>152587</b>	16 cm	Blíster	DP Macho - HDMI/VGA Hembra	HDMI 4K, VGA 1080p, Pasivo



**Cable convertidor de Displayport a VGA**

Modelo	Longitud	Empaque	Conexión	Resolución
<b>◆ 151962</b>	15 cm	Bolsa	DP Macho -VGA Hembra	1080p, Activo



**Adaptador DisplayPort 1.2a a DVI-D**

Modelo	Longitud	Empaque	Conexión	Resolución
<b>152228</b>	23 cm	Bolsa	DP Macho - DVI-D Hembra	1080p, Activo



**Adaptador Activo Mini-DisplayPort a HDMI**

Modelo	Empaque	Conexión	Resolución
<b>152570</b>	Bolsa	Mini DP Macho - HDMI Hembra	4K, Activo
<b>152501</b>	Blíster	Mini DP Macho - HDMI Hembra	4K, Activo





## Adaptadores y Convertidores Mini DisplayPort

### Adaptador Pasivo de Mini DisplayPort a HDMI

Modelo	Longitud	Empaque	Conexión	Resolución
<b>•322461</b>	17 cm	Bolsa	Mini DP Macho - HDMI Hembra	1080p, Pasivo



### Adaptador Mini DisplayPort a HDMI

Modelo	Longitud	Empaque	Conexión	Resolución
<b>151399</b>	17 cm	Blíster	Mini DP Macho - HDMI Hembra	1080p, Pasivo



### Adaptador Mini DisplayPort a VGA

Modelo	Longitud	Empaque	Conexión	Resolución
<b>322508</b>	17 cm	Bolsa	Mini DP Macho - VGA Hembra	1080p, Pasivo



### Adaptador Mini DisplayPort a VGA

Modelo	Longitud	Empaque	Conexión	Resolución
<b>151382</b>	17 cm	Blíster	Mini DP Macho - VGA Hembra	1080p, Activo



### Adaptador Mini-DisplayPort a DVI

Modelo	Empaque	Conexión	Resolución
<b>322485</b>	Bolsa	Mini DP Macho - DVI-I Doble Enlace Hembra	1080p



### Adaptador Activo Mini-DisplayPort a DVI-I

Modelo	Empaque	Conexión	Resolución
<b>152488</b>	Blíster	Mini DP Macho - DVI-I Doble Enlace Hembra	4K, Activo
<b>152549</b>	Bolsa	Mini DP Macho - DVI-I de Doble Enlace Hembra	4K, Activo
<b>152532</b>	Blíster	Mini DP Macho - DVI-I de Doble Enlace Hembra	1080p, Pasivo



**Adaptadores y Convertidores Mini DisplayPort**

**Adaptador 3 en 1 Mini DisplayPort**

Modelo	Longitud	Empaque	Conexión	Resolución
<b>207713</b>	25 cm	Blíster	Mini DP Macho - HDMI/VGA/DVI Hembra	1080p, Pasivo
<b>207720</b>	25 cm	Blíster	Mini DP Macho - HDMI/VGA/DVI Hembra	VGA/DVI 1080p, HDMI 4K, Pasivo



**Adaptador 2 en 1 Mini DisplayPort 4K**

Modelo	Longitud	Empaque	Conexión	Resolución
<b>152709</b>	25 cm	Blíster	Mini DP Macho - HDMI/VGA Hembra	VGA 1080p, HDMI 4K, Pasivo



**207768. Hub Video Splitter de DisplayPort a 2 DisplayPort con MST**





Modo:  
Espejo



Modo: Escritorio  
extendido



Modo:  
Video Wall



4K@30Hz,  
video 3D y MST

**152716. Hub Video Splitter de DisplayPort a 2 HDMI, con MST**





Modo:  
Espejo



Modo: Escritorio  
extendido



Modo:  
Video Wall



4K@30Hz,  
video 3D y MST

**207775. Hub Video Splitter de Mini DisplayPort a 2 DisplayPort, con MST**





Modo:  
Espejo



Modo: Escritorio  
extendido



Modo:  
Video Wall



4K@30Hz,  
video 3D y MST

**152723. Hub Video Splitter de Mini DisplayPort a 2 HDMI, con MST**





Modo:  
Espejo

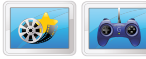

Modo: Escritorio  
extendido



Modo:  
Video Wall



4K@30Hz,  
video 3D y MST



**152952. Adaptador de USB-C a dos puertos DisplayPort – Hub MST**

**NUEVO**



Modo: Espejo	Modo: Escritorio extendido	Modo: Video Wall	UHD, 4K@30Hz

**152969. Convertidor de USB-C a dos puertos HDMI – Hub MST**

**PRÓXIMAMENTE**



Modo: Espejo	Modo: Escritorio extendido	Modo: Video Wall	UHD, 4K@30Hz

**207737. Hub Video Splitter de DisplayPort a 4 DisplayPort, con MST**



Modo: Espejo	Modo: Escritorio extendido	Modo: Video Wall	4K@30Hz, video 3D y MST

**207744. Hub Video Splitter de Mini DisplayPort a 4 DisplayPort, con MST**



Modo: Espejo	Modo: Escritorio extendido	Modo: Video Wall	4K@30Hz, video 3D y MST

**Cables y adaptadores DisplayPort y Mini DisplayPort**



**Cable DVI-D - Enlace Dual**

Modelo	Longitud	Empaque	Conexión
<b>328838</b>	1.8 m	Bolsa	DVI-D Enlace Dual Macho - DVI-D Enlace Dual Macho
<b>371803</b>	3.0 m	Bolsa	DVI-D Enlace Dual Macho - DVI-D Enlace Dual Macho
<b>301244</b>	5.0 m	Bolsa	DVI-D Enlace Dual Macho - DVI-D Enlace Dual Macho



**Cable DVI-D - Enlace Sencillo**

Modelo	Longitud	Empaque	Conexión
<b>328821</b>	1.8 m	Bolsa	DVI-D Enlace Sencillo Macho a DVI-D Enlace Sencillo Macho

**Adaptadores y Convertidores DVI**



**Cable para monitor**

Modelo	Longitud	Empaque	Conexión
◆ <b>372503</b>	1.8 m	Bolsa	HDMI Macho - DVI-D 24+1 Enlace Dual Macho
<b>372510</b>	3.0 m	Bolsa	HDMI Macho - DVI-D 24+1 Enlace Dual Macho
<b>372527</b>	4.5 m	Bolsa	HDMI Macho - DVI-D 24+1 Enlace Dual Macho

**Cable HDMI a DVI-D**

Modelo	Longitud	Empaque	Conexión
<b>354592</b>	20 cm	Bolsa	HDMI Macho - DVI-D Enlace Dual Hembra

**Adaptadores y Convertidores DVI**



**Cable Mini DisplayPort 1.2a a DVI**

Modelo	Longitud	Empaque	Conexión
<b>152150</b>	1.8 m	Bolsa	Mini DP Macho - DVI-D Macho

**Adaptador Mini-DisplayPort a DVI**

Modelo	Empaque	Conexión	Resolución
<b>322485</b>	Bolsa	Mini DP Macho - DVI-I Doble Enlace Hembra	1080p, Pasivo
<b>152549</b>	Bolsa	Mini DP Macho - DVI-I Doble Enlace Hembra	4K, Activo
<b>152532</b>	Blíster	Mini DP Macho - DVI-I Doble Enlace Hembra	1080p, Pasivo

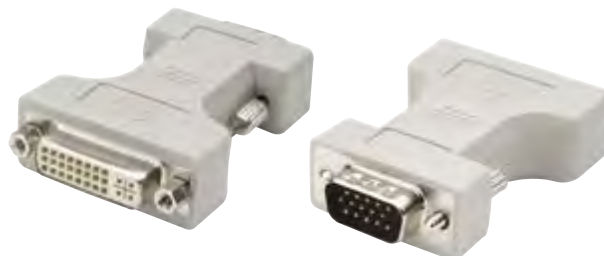

**Adaptador de video digital**

Modelo	Empaque	Conexión
◆ <b>328883</b>	Bolsa	DVI-I Enlace Doble Macho - VGA Hembra

**Adaptador de video digital**

Modelo	Empaque	Conexión
<b>328906</b>	Bolsa	DVI-I Hembra - VGA Macho

**151542. Micro Convertidor HDMI a VGA con salida de audio**

**NUEVO**



VGA hembra de 15 pines	HDMI macho de 19 pines	Jack de 3.5 mm hembra	Micro-USB hembra	1920x1200 (1080p)

**Convertidor HDMI a VGA+Audio**

**151450. Blíster**    **151559. Bolsa**



VGA Hembra	HDMI Macho	3.5 mm Macho 3.5 mm Hembra	Micro-USB Hembra (energía)	Resolución: 1080p

**177351. Convertidor de video SVGA HD15 + audio a HDMI**



Entrada: VGA Macho	Entrada: 2 RCA Hembra	Salida: HDMI Hembra	1280 x 1024, 1080p

**Convertidor HDMI a VGA**

**151436. Blíster**    **151467. Bolsa**



VGA Hembra	HDMI Macho	Micro-USB Hembra	Resolución: 1080p

**152426. Convertidor de video VGA y USB a HDMI**



Entrada: VGA Macho	Entrada: USB-A Macho	Salida: HDMI Hembra	Hasta 1920 x 1080, 1080p @ 60 Hz

**152075. Estación Docking Replicador de puertos USB Tipo-C 6 en 1**



Entrada: USB-C, macho	Salida: HDMI, hembra	RJ45, hembra
2 USB-A, hembras	Memoria SD	USB-C PD, hembra

**152808. Estación Docking USB-C SuperVelocidad 7 en 1**



Entrada: USB-C, macho



Salida: HDMI, hembra



Mini DisplayPort, hembra



VGA, hembra



RJ45, hembra



3 USB-A, hembras



Memoria SD



Memoria Micro-SD



3.5 mm, hembra



USB-C PD, hembra

**152631. Convertidor Docking USB-C Superspeed 4-en-1 a HDMI/VGA**



Entrada: USB-C, macho



Salida: HDMI, hembra



VGA, hembra



2 USB-A, hembra



Memoria SD

**152990. Convertidor de USB-C a Multipuertos de A/V – Hub MST**

**NUEVO**



Entrada: USB-C, macho



Salida: HDMI, hembra



DisplayPort, hembra



VGA, hembra

**152983. Convertidor de USB-C a Multipuertos de A/V 3 en 1**

**NUEVO**



Entrada: USB-C, macho



Salida: HDMI, hembra



DVI, hembra



VGA, hembra

**152600. Convertidor Video USB-C a HDMI/DP/SVGA/DVI**



Entrada: USB-C, macho



Salida: HDMI, hembra



DisplayPort, hembra



DVI, hembra



VGA, hembra

**152037. HDMI Docking convertidor USB tipo-C**



Entrada: USB-C, macho



Salida: HDMI, hembra



USB-A, hembra



USB-C PD, hembra

**152044. Convertidor Docking USB, tipo-C y VGA**



Entrada: USB-C, macho



VGA, hembra



USB-A, hembra



USB-C PD, hembra

**151788. Convertidor USB 3.1 a HDMI**



Entrada: USB-C, macho



Salida: HDMI, hembra

**152020. Convertidor USB 3.1 a DisplayPort**



Entrada: USB-C, macho



DisplayPort, hembra

**152051. Convertidor USB 3.1 a DVI**



Entrada: USB-C, macho



DVI, hembra

**151771. Convertidor USB-C 3.1 a VGA**



Entrada: USB-C, macho



VGA, hembra

**Cable adaptador USB-C a HDMI**

152235.1 m    151764.2 m



Longitud:  
152235.1 m  
151764.2 m



Entrada:  
USB-C, macho



Salida: HDMI,  
hembra



Resolución:  
Hasta 3840 x  
2160 @ 30 Hz

**Cable adaptador USB-C a DisplayPort**

152471.1m    152464.2 m



Longitud:  
152471.1 m  
152464.2 m



Entrada:  
USB-C, macho



DisplayPort,  
hembra



Resolución:  
4K, UHD

**152457. Cable adaptador USB-C a DVI**



Longitud:  
2.0 m



Entrada:  
USB-C,  
macho



DVI,  
hembra



Ancho de  
banda: 2.25  
Gbps por  
canal



Resolución:  
Hasta 2520 x  
1600 @ 60 Hz

**151061. Convertidor USB 2.0 a puerto de video HDMI**



USB-A  
Macho



HDMI  
Hembra



Resolución:  
1080p



Ideal para conectar PCs a TV,  
proyectors, pantallas LCD  
de alta definición

**152334. Convertidor USB 2.0 a DVI-I**



USB-A  
Macho



DVI  
Hembra



Resolución: 1680 x 1050  
@ 32-bit color; Video HD  
720 p/1080 i

**152310. Convertidor Video USB 3.0 a DVI-I Hembra**



USB-A 3.0  
Macho



DVI-I  
Hembra



Resoluciones: Hasta  
2048 x 1152 @ 32 bit  
color; 1080p Full HD video



**179225. Convertidor USB 2.0 a puerto de video SVGA HD15 (resolución 1280 x 1040)**



Hasta 6 monitores



USB-A



SVGA



Resoluciones:  
Hasta 1600 x 1200

**152327. Convertidor Video USB 3.0 a DisplayPort H**



USB-A 3.0 Macho



DisplayPort Hembra



Resoluciones: Hasta 3840 x 2160 @ 30 Hz

**152259. Convertidor Video USB 3.0 a HDMI Hembra**



USB-A 3.0 Macho



HDMI Hembra



Resoluciones:  
Hasta 2560 x 1440 en 32-bit color;  
Soporta video 1080p full HD

**152303. Convertidor Video USB 3.0 a SVGA Hembra**



USB-A 3.0 Macho



SVGA Hembra



Resoluciones:  
Hasta 2048 x 1152 @ 32-bit color

**162579. Conv. Importador imágenes/sonido USB 2.0**



Entradas: S-video, RCA para audio y video



USB-A



Resoluciones:  
NTSC; 720 X 480 a 30 cuadros por segundo, PAL; 720 X 576 a 25 cuadros por segundo

**207638. Extensor Video HDMI 4K, 40 m/70 m**



Hasta 70 m



Resoluciones:  
1080p hasta 70 m  
4K hasta 40 m

**177269. Extensor de video HDMI**



Hasta 60 m



Resoluciones:  
Hasta 1080p

**207461. Kit extensor de HDMI sobre Ethernet**



Hasta 50 m



Resoluciones:  
Hasta 1080p

**207386. Extensión HDMI, Cat 5e/Cat 6**



Hasta 30 m



Resoluciones:  
Hasta 1080p

**177344. Extensor de video SVGA + audio**



Hasta 300 m



VGA



Stereo  
3.5 mm



Resoluciones:  
Hasta 1920 x 1200

**207621. Repetidor HDMI, 4K, Activo**



4K  
hasta 40 m



Resoluciones:  
1080p-hasta 50m  
4K@30Hz-hasta 40m  
4K@60Hz-hasta 25m



Entrada HDMI:  
Cable 5-25 m  
Salida HDMI:  
Cable 1-15 m



Entrada  
Micro-B USB:  
Energía  
adicional

**207799. Repetidor HDMI, 1080p, Activo**



Hasta 45 m



Resolución:  
Hasta 1080p



Longitud del cable de fuente  
a repetidor: De 5 - 20 m  
Longitud del cable del repetidor  
a la pantalla: De 5 - 25 m

**207447. Repetidor HDMI**



Hasta 40 m



Resoluciones: 1080p, así como video HD 3-D



Entrada HDMI: Cable 5-25 m  
Salida HDMI: Cable 1-15 m

**207553. Switch HDMI de 3 puertos**



**3 UHD**

Conecta 3 fuentes de video UHD



Control remoto



Resoluciones: 4K@60Hz, Video full 3D

**207522. Switch HDMI de 3 puertos**



**3 UHD**

Conecta 3 fuentes de video UHD



Control remoto



Resoluciones: 4K@30Hz, Video full 3D

**207423. Switch HDMI 1.3, 3 puertos**



**3 HD**

Conecta 3 fuentes de video HD

**HD**

Detecta automáticamente una señal HD



Resoluciones: Hasta 1080p

**207416. Switch HDMI 1.3, 2 puertos**



**2 HD**

Conecta 2 fuentes de video HD

**HD**

Detecta automáticamente una señal HD



Resoluciones: Hasta 1080p

**207911. Switch HDMI 1080p de 2 puertos**



**2 HDMI**

Conecta 2 fuentes de video HDMI



Conmutación automática y manual



Resoluciones: 1080p

**207928. Matriz 4x4 para video wall 1080p HDMI para 4 pantallas**

**PRÓXIMAMENTE**



**4**

Comparte hasta 4 fuentes HDMI entre 4 pantallas



Con función de video wall



Control remoto



Resoluciones: Hasta 1080p

**207904. Matrix HDMI 1080p 4x4**

**NUEVO**



**4**

Comparte hasta 4 fuentes HDMI entre 4 pantallas



Control remoto



Resoluciones: Hasta 1080p

**207409. Matriz HDMI 4K, de 4 fuentes a 2 pantallas**

**ÚLTIMAS PIEZAS**



**4 HDMI**

Conecta 4 fuentes HDMI entre 2 pantallas



Control remoto



Resoluciones: 4K@30Hz

**207898. Matriz HDMI 4 x 2 1080p**

**PRÓXIMAMENTE**



**2**

Comparte hasta 4 fuentes HDMI entre 2 pantallas



Control remoto



Resoluciones: Hasta 1080p

**207492. Video Splitter HDMI 1.4, de 8 puertos**



**8 HDMI**

Conecta 8 fuentes de video HDMI



Resoluciones: 4K

**207515. Video Splitter HDMI de 4 puertos**



**4 HDMI**

Conecta 4 pantallas HDMI, 4K



Conexión en cascada hasta 5 splitters para 16 pantallas 4K



Resoluciones: 4K@30Hz

177146. Video splitter HDMI



**4 HDMI**

Conecta 4 fuentes de video HDMI



Se puede conectar en cascada hasta 3 niveles



Resoluciones: Hasta 1080p

207591. Video Splitter HDMI 4K de 2 puertos



**2 HDMI**

Duplica una señal a dos pantallas UHD



Resoluciones: 4K@60Hz

207669. Splitter HDMI de 2 puertos



**2**

Hasta 2 pantallas HDMI



Resoluciones: 4K@30Hz

207652. Video Splitter HDMI de 2 puertos, 1080p



**2 HD**

2 pantallas HD



Se puede conectar en cascada hasta 3 niveles



Resoluciones: Hasta 1080p

208215. Video splitter SVGA de 4 puertos, 1080p



**4**

Multiplica una señal de video en 4 salidas VGA



Resoluciones: 1080p

207348. Video splitter SVGA



**4 VGA**

Multiplica una señal VGA hasta en 4 salidas



Transmisiones efectivas de hasta 65 m



Resoluciones: Hasta 1920 x 1080

**Cable MHL de Micro USB a HDMI**

151498. 1.5 m    151511. 0.76 m



Entrada:  
Micro USB



Salida:  
HDMI



Alimentación:  
USB-A



MHL



Resolución:  
1080p

**207607. Extensor Video HDMI, 60M via Cat 5e/6 Pared**



Hasta  
60 m



Resoluciones:  
Hasta 1080p



1 HDMI  
hembra



1 RJ45  
hembra



1 puerto DC-5V



1 puerto infrarrojo



1 terminal 5VDC/1A

**Placa de pared, con conectores HDMI**



Modelo	Puertos	Empaque	Conectores
771719	1	Bolsa	HDMI Hembra a HDMI Hembra, Tipo Cople

Modelo	Puertos	Empaque	Conectores
771726	2	Bolsa	HDMI Hembra a HDMI Hembra, Tipo Cople

**771351. Cople HDMI, Tipo Keystone**



Compatible con paneles de parcheo, tapas y cajas de pared.



HDMI hembra a HDMI hembra



Resoluciones:  
Hasta 4K

**772167. Jack Keystone con puerto USB de carga**



1 puerto de carga USB-A



Salida 5V/1A



**manhattan**<sup>®</sup>  
Life just got easier.<sup>™</sup>

# CABLES Y ADAPTADORES PARA DATOS Y ENERGÍA



USB



**USB 3.1 Gen 2, C Macho - A Macho**

Modelo	Longitud	Empaque	Color
354639	50 cm	Bolsa	Negro
353373	1.0 m	Bolsa	Negro



**USB 3.1 Gen 2, C Macho - B Macho**

Modelo	Longitud	Empaque	Color
353380	1.0 m	Bolsa	Negro



**USB 3.1 Gen 2, C Macho - Micro-B Macho**

Modelo	Longitud	Empaque	Color
353397	1.0 m	Bolsa	Negro



**USB 3.1 Gen 2, C Macho - C Macho**

Modelo	Longitud	Amperes	Empaque	Color
354899	50 cm	3 A	Bolsa	Negro
353526	1.0 m	3 A	Bolsa	Negro
355223	1.0 m	5 A	Bolsa	Negro



**USB Gen 3.1 Gen 2, C Macho - C Hembra, Extensión**

Modelo	Longitud	Amperes	Empaque	Color
355230	50 cm	5 A	Bolsa	Negro



**USB 3.1 Gen 2, C Hembra - A Macho, Adaptador**

Modelo	Empaque	Color
354714	Bolsa	Negro



**USB 3.1 Gen 1, C Macho - A Macho**

Modelo	Longitud	Empaque	Color
354974	1.8 m	Bolsa	Negro
354981	3.0 m	Bolsa	Negro



**USB 3.1 Gen 1, C Macho - A Hembra**

Modelo	Longitud	Empaque	Color
353540	15 cm	Bolsa	Azul



USB



**USB 3.1 Gen 1, C Macho - B Macho**

Modelo	Longitud	Empaque	Color
<b>354998</b>	2.0 m	Bolsa	Negro



**USB 3.1 Gen 1, C Macho - C Macho**

Modelo	Longitud	Empaque	Color
<b>354905</b>	1.8 m	Bolsa	Negro



**USB 3.1 Gen 1, A Hembra - C Macho, Adaptador**

Modelo	Empaque	Color
<b>354646</b>	Bolsa	Negro



**USB 3.1 Gen 1, Micro-B Hembra - C Macho, Adaptador**

Modelo	Empaque	Color
<b>354660</b>	Bolsa	Negro



**USB 3.1, Mini-B Hembra - C Macho, Adaptador**

Modelo	Empaque	Color
<b>354677</b>	Bolsa	Negro



**USB 3.0, A Macho - Micro-B Macho**

Modelo	Longitud	Empaque	Color
<b>393898</b>	1.0 m	Blíster	Azul
<b>♦ 325424</b>	2.0 m	Bolsa	Azul



**USB 2.0, C Macho - A Macho**

Modelo	Longitud	Empaque	Color
<b>354912</b>	50 cm	Bolsa	Negro
<b>353298</b>	1.0 m	Bolsa	Negro
<b>354929</b>	2.0 m	Bolsa	Negro
<b>354936</b>	3.0 m	Bolsa	Negro
<b>354943</b>	5.0 m	Bolsa	Negro



**USB 2.0, C Macho - B Macho**

Modelo	Longitud	Empaque	Color
<b>353304</b>	1.0 m	Bolsa	Negro
<b>354950</b>	2.0 m	Bolsa	Negro

**USB**



**USB 2.0, C Macho - C Macho**

Modelo	Longitud	Amperes	Empaque	Color
<b>354868</b>	50 cm	3.0 A	Bolsa	Negro
<b>354875</b>	2.0 m	3.0 A	Bolsa	Negro
<b>354882</b>	3.0 m	3.0 A	Bolsa	Negro



**USB 2.0, C Macho - C Macho**

Modelo	Longitud	Amperes	Empaque	Color
<b>353342</b>	1.0 m	3.0 A	Bolsa	Negro



**USB 2.0, C Macho - C Macho**

Modelo	Longitud	Amperes	Empaque	Color
<b>355247</b>	2.0 m	5.0 A	Bolsa	Negro



**USB 3.0, A Macho - Micro-B Macho**

Modelo	Longitud	Empaque	Color
<b>353311</b>	1.0 m	Bolsa	Negro



**USB 3.0, A Macho - Micro-B Macho**

Modelo	Longitud	Empaque	Color
<b>354967</b>	2.0 m	Bolsa	Negro



**USB 2.0, C Macho - Micro-B Hembra**

Modelo	Longitud	Empaque	Color
<b>353335</b>	15 cm	Bolsa	Negro



**USB 2.0, C Macho - Mini-B Macho**

Modelo	Longitud	Empaque	Color
<b>353328</b>	1.0 m	Bolsa	Negro



**USB 2.0, C Hembra - A Macho, Adaptador**

Modelo	Empaque	Color
<b>354653</b>	Bolsa	Negro

**USB**



**ÚLTIMAS PIEZAS**

**USB 2.0, Micro-B Macho - Mini-B Hembra, Adaptador**

Modelo	Empaque	Color
<b>322492</b>	Bolsa	Negro



**USB 2.0, A Macho - A Macho**

Modelo	Longitud	Empaque	Color
<b>306089</b>	1.8 m	Bolsa	Negro



**USB 2.0, A Macho - B Macho**

Modelo	Longitud	Empaque	Color
<b>374507</b>	0.5 m	Bolsa	Negro
◆ <b>333368</b>	1.8 m	Bolsa	Negro
◆ <b>333405</b>	1.8 m	Bolsa	Negro
<b>393737</b>	1.8 m	Blíster	Negro
<b>308762</b>	1.8 m	Bolsa	Blanco
◆ <b>333382</b>	3.0 m	Bolsa	Negro
◆ <b>340458</b>	3.0 m	Bolsa	Negro
◆ <b>340465</b>	4.5 m	Bolsa	Plateado
<b>337779</b>	5.0 m	Bolsa	Negro
◆ <b>345408</b>	5.0 m	Bolsa	Plateado



**USB 2.0, Cable de Extensión, A Macho - A Hembra**

Modelo	Longitud	Empaque	Color
◆ <b>336314</b>	1.8 m	Bolsa	Plateado
<b>340496</b>	3.0 m	Bolsa	Plateado
◆ <b>340502</b>	5.0 m	Bolsa	Plateado



**USB 2.0, A Macho - Micro-B Macho**

Modelo	Longitud	Empaque	Color
◆ <b>325677</b>	0.5 m	Bolsa	Negro
<b>393874</b>	1.0 m	Blíster	Negro
<b>323987</b>	1.0 m	Bolsa	Blanco
<b>307161</b>	1.0 m	Bolsa	Negro
<b>324069</b>	1.8 m	Bolsa	Blanco
<b>325684</b>	3.0 m	Bolsa	Negro
◆ <b>307178</b>	1.8 m	Bolsa	Negro



**USB 2.0, Cubierta Textil, A Macho - Micro-B Macho**

Modelo	Longitud	Empaque	Color
<b>352772</b>	1.0 m	Bolsa	Verde/Negro
<b>394062</b>	1.0 m	Blíster	Verde/Negro
<b>352734</b>	1.0 m	Bolsa	Naranja/Azul
<b>394024</b>	1.0 m	Blíster	Naranja/Azul
<b>352758</b>	1.0 m	Bolsa	Rosa/Morado
<b>394048</b>	1.0 m	Blíster	Rosa/Morado
<b>352710</b>	1.0 m	Bolsa	Amarillo/Aqua
<b>394000</b>	1.0 m	Blíster	Amarillo/Aqua
<b>352765</b>	1.8 m	Bolsa	Verde/Negro
<b>352727</b>	1.8 m	Bolsa	Naranja/Azul
<b>352741</b>	1.8 m	Bolsa	Rosa/Morado



USB



USB 2.0, Planos, A Macho - Micro-B Macho

Modelo	Longitud	Empaque	Color
391368	1.0 m	Blíster	Morado/Negro
391436	1.0 m	Blíster	Azul/Amarillo
391443	1.0 m	Blíster	Rosa/Verde
391283	2.0 m	Blíster	Azul/Amarillo



USB 2.0, A Macho - Mini-B Macho

Modelo	Longitud	Empaque	Color
◆ 333375	1.8 m	Bolsa	Negro
◆ 333412	1.8 m	Bolsa	Plateado



Cable de Extensión Activa USB de Súper Velocidad

Modelo	Longitud	Empaque	Conexión	Versión USB
150712	5.0 m	Bolsa	A Macho - A Hembra	SuperSpeed



Cable Extensión Activa USB de Alta Velocidad 2.0

Modelo	Longitud	Empaque	Conexión	Versión USB
519779	5.0 m	Blíster	A Macho - A Hembra	Hi-Speed
151573	10.0 m	Bolsa	A Macho - A Hembra	Hi-Speed
150958	20.0 m	Caja	A Macho - A Hembra	Hi-Speed



Cable de Extensión Activa USB de Alta Velocidad

Modelo	Longitud	Empaque	Conexión	Versión USB
510424	11.0 m	Bolsa	A Macho - B Macho	Hi-Speed



Cable USB 1.1 de A macho - B macho

Modelo	Longitud	Empaque	Conexión	Color
◆ 317856	1.8 m	Bolsa	A Macho - B Macho	Gris
◆ 342650	1.8 m	Bolsa	A Macho - B Macho	Negro
◆ 317863	3.0 m	Bolsa	A Macho - B Macho	Gris
◆ 341028	4.5 m	Bolsa	A Macho - B Macho	Gris

USB



**Cable USB 1.1 de A macho - B macho, económico**

Modelo	Longitud	Empaque	Color
♦ 771023	1.8 m	Bolsa	Negro



**Cable de Extensión USB 1.1 de A Macho - A Hembra**

Modelo	Longitud	Empaque	Color
♦ 165211	1.8 m	Bolsa	Gris
♦ 317238	3.0 m	Bolsa	Gris
♦ 340960	4.5 m	Bolsa	Gris

**179300. Extensor de línea USB**



Longitud:  
60 m



Empaque:  
Blíster



Color:  
Negro



**Cables USB 1.1 A Macho - A Macho**

Modelo	Longitud	Empaque	Color
♦ 317887	1.8 m	Bolsa	Gris

**354196. Cable USB A-H Alim. 3.5 mm, 5V DC**



Longitud:  
1 m



Color:  
Negro

**354202. Cable USB A-M Alim. 5.5 mm, 5V DC**



Longitud:  
1 m



Color:  
Negro

**354219. Cable USB A-N Alim. 5.5 mm, 5V DC**



Longitud:  
1 m



Color:  
Negro

**354240. Cable USB V2.0, A-Samsung 30 pines**



Longitud:  
1 m



Color:  
Negro

**391856. Cable USB para iPhone/iPod/iPad**



Longitud:  
1.0 m



Tasa de transferencia:  
480 Mbps

**390613. Cable para carga/sincronización iLynk**



**ÚLTIMAS PIEZAS**



Longitud:  
1.0 m



Carga y sincroniza  
tu smartphone, tableta y más

**353434. Cable de carga y datos USB 3 en 1**



**PRÓXIMAMENTE**



Longitud:  
1.0 m



Tasa de transferencia:  
480 Mbps



Conector  
Lightning



Conector  
USB Micro-B



Conector  
USB-C

**Cable USB-C a Lightning para carga y sincronización**

**354424. 0.5 m**

**354462. 1.8 m**

**PRÓXIMAMENTE**



Longitud:  
**354424. 0.5 m**  
**354462. 1.8 m**



Tasa de transferencia:  
480 Mbps

**390620. Adaptador Lightning (Micro-B Hembra - Lightning Macho)**

ÚLTIMAS PIEZAS



**Cable iLynk Lightning**

Modelo	Longitud	Empaque	Color
<b>391467</b>	1.0 m	Blíster	Azul
<b>394215</b>	1.0 m	Blíster	Verde
<b>394222</b>	1.0 m	Blíster	Rosa
<b>394239</b>	1.0 m	Blíster	Morado
♦ <b>393744</b>	1.0 m	Blíster	Blanco
<b>394345</b>	1.0 m	Blíster	Gris Acero + Textil
<b>390842</b>	1.8 m	Blíster	Blanco
<b>390866</b>	3.0 m	Blíster	Blanco

**Cables de audio**

ÚLTIMAS PIEZAS



**3.5 mm Estéreo, Macho - Macho**

Modelo	Longitud	Empaque	Color
<b>393935</b>	1.0 m	Blíster	Negro
♦ <b>334594</b>	1.8 m	Bolsa	Negro
<b>354585</b>	5.0 m	Bolsa	Negro

**3.5 mm Estéreo, Hembra - 2xMacho**

Modelo	Longitud	Empaque	Color
<b>354578</b>	20 cm	Bolsa	Negro



**3.5 mm Estéreo, Macho - 2xHembra**

Modelo	Longitud	Empaque	Color
<b>354561</b>	20 cm	Bolsa	Blanco

**Cables de audio**



**Cable de Audio con recubrimiento textil, 3.5 mm, estéreo, Macho - Macho**

Modelo	Longitud	Empaque	Color
<b>394130</b>	1.0 m	Blíster	Verde/Negro
<b>352826</b>	1.0 m	Bolsa	Rosa/Morado
<b>394116</b>	1.0 m	Blíster	Rosa/Morado
<b>394093</b>	1.0 m	Blíster	Naranja/Azul
<b>352802</b>	1.0 m	Bolsa	Naranja/Azul
<b>352833</b>	1.8 m	Bolsa	Rosa/Morado
<b>352819</b>	1.8 m	Bolsa	Naranja/Azul

**394178. Display con 60 cables micro USB V2.0 A-micro B**



**CABLE POP**

**60**  
Cables

**390682. Display con 60 cables estéreo M-M**



**AUDIO POP**

**60**  
Cables

**178822. Display con 40 audífonos intraauricular**



**SONIDO POP**

**40**  
Audífonos

**Cable de corriente, CPU/monitor a pared**

**393911. Empaque blíster**

**♦ 300179. Empaque bolsa**



Longitud:  
393911. 1.8 m  
♦ 300179. 1.8 m



Potencia:  
393911. 10 A / 125 V  
♦ 300179. 10 A / 250 V



Protección  
de tensión

**323338. Cable Corriente CPU/monitor a pared**



Longitud:  
3.0 m



Potencia:  
10 A / 250 V



Protección  
de tensión

**♦ 301152. Cable de corriente**



Longitud:  
1.8 m



Potencia:  
10 A / 250 V



Protección  
de tensión

**♦ 348591. Cable corriente para laptop**



Longitud:  
1.8 m



Conector triple



♦ 342766. Cable de alimentación interna SATA, Molex a SATA, 15 pines



Longitud:  
20 cm



Contactos SATA con baño de oro

354554. Cable corriente int. HDD SATA, 1 m - 2h



Longitud:  
15 cm



Contactos SATA con baño de oro

♦ 349369. Cable de alimentación interna SATA, "Y" 1 Molex a 2 SATA de 15 pines

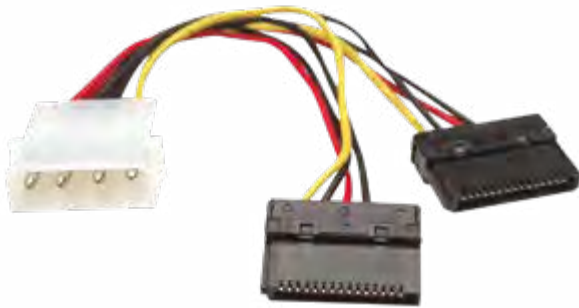

Longitud:  
15 cm



Contactos SATA con baño de oro

301503. Cable de alimentación interna en "Y" Molex 1 a 2

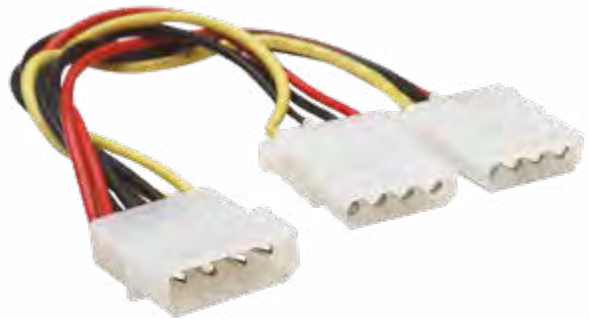

Longitud:  
20 cm



Moldeado  
en PVC

♦ 340700. Cable de datos SATA



Longitud:  
50 cm



Tasa de transferencia:  
Hasta 6 Gbps



Blindado

305808. Cable de Datos SATA



Longitud:  
50 cm



Tasa de  
transferencia:  
Hasta 6 Gbps



Conector a 90° que proporciona  
una mejor administración  
del cable



370486. Cable para dispositivos FireWire 800/400



Longitud:  
1.8 m



Tasa de  
transferencia: 400 Mbps

314770. Cable null módem



Longitud:  
1.8 m

8

8 conductores



Blindado

301404. Cable null módem



Longitud:  
2 m



Moldeado  
en PVC

303033. Cable para impresora



Longitud:  
1.8 m



Blindado

150859. Adaptador de Audio 3-D USB de Alta Velocidad



Sonido  
estéreo 7.1



1 entrada  
de micrófono



1 salida  
de audio



1 USB 2.0  
A-Macho

152754. Adaptador de Sonido Estéreo USB de Alta Velocidad



Sonido  
estéreo 2.1



1 entrada  
de micrófono



1 salida  
de audio



1 USB 2.0  
A-Macho

151429. Convertidor USB a Tarjeta de Sonido 7.1



Sonido estéreo 5.1



1 entrada de micrófono



1 salida de audio



1 USB 2.0 A-Macho

130424. Convertidor USB 3.0 a HDD SATA 2.5"



Tasa de transferencia: Hasta 5 Gbps



Discos duros externos SATA 2.5"

151825. Convertidor USB 3.0 a HDD SATA 2.5"

**NUEVO**



Tasa de transferencia: Hasta 5 Gbps



Permite la transferencia de datos entre SATA, CFAST y USB 3.0 SuperSpeed

152976. Adaptador USB 3.1 SuperSpeed a SATA y CFAST

**NUEVO**



Tasa de transferencia: Hasta 5 Gbps



Permite la transferencia de datos entre SATA, CFAST y USB 3.0 SuperSpeed

179195. Convertidor USB 2.0 a conectores IDE/SATA



Tasa de transferencia: Hasta 1.5 Gbps



Función de respaldo de un solo toque

Convertidor USB 1.1 a conector Centronics 36

317474. Paquete retail

317016. Paquete bolsa



Longitud: 1.8 m



Tasa de transferencia: Hasta 12 Mbps



**336581. Convertidor USB a Paralelo para impresora**



Longitud:  
1.8 m



Tasa de transferencia:  
Hasta 1.2 Mbps

**179027. Convertidor USB a PS/2 (2 Puertos)**



Ideal para conectar teclado y ratón  
de una computadora

**150439. Convertidor USB a RS485**



Longitud:  
80 cm



Tasa de transferencia:  
Hasta 1 Mbps



**Convertidores seriales**

Modelo	Longitud	Empaque	Color
<b>151566</b>	45 cm	Serial a un puerto USB Tipo-C, Chip FTDI FT232RL	Negro
<b>151283</b>	45 cm	Serial a un puerto USB Tipo-C, chip Prolific PL-2303RA	Negro



**Convertidores seriales**

Modelo	Longitud	Empaque	Color
<b>151801</b>	45 cm	Serial a un puerto USB, Chip Prolific PL-2303HXD	Negro
<b>151832</b>	1.8 m	Serial a un puerto USB, Chip Prolific PL-2303HXD	Negro
<b>151849</b>	1.8 m	Serial a un puerto USB, Chip Prolific PL-2303RA	Negro
<b>151856</b>	45 cm	Serial a un puerto USB, Chip FTDI FT232RL	Negro



**Convertidores seriales**

Modelo	Longitud	Empaque	Color
<b>◆ 205153</b>	45 cm	Serie a un puerto USB, Bolsa	Negro
<b>◆ 205146</b>	45 cm	Serie a un puerto USB, Blíster	Negro

**174947. Convertidor USB-A a 2 puertos seriales**



Longitud:  
45 cm



Convertidor USB-A  
a 2 puertos seriales



Color:  
Negro

**151047. Convertidor Serial**



Convertidor USB-A  
a 4 puertos seriales



Color:  
Plateado

**151054. Convertidor Serial**



Convertidor USB-A  
a 8 puertos seriales



Color:  
Negro

**152495. Convertidor USB-C 3.1 a HDD SATA 2.5**



Longitud:  
25 cm



Tasa de transferencia:  
Hasta 10 Gbps

**152525. Convertidor USB-C a CEN36 1.0 m,  
para impresora**



Longitud:  
1.0 m



Tasa de transferencia:  
Hasta 12 Mbps

**152518. Convertidor USB-C a DB25 1.0 m,  
para impresora**



Longitud:  
1.0 m



Tasa de transferencia:  
Hasta 12 Mbps



### 154109. Modem USB



Tasa de descarga:  
56 Kbps

### 406239. Adaptador OTG USB 2.0 + 2 Puertos USB + 24 en 1, Negro



2 puertos  
USB 2.0



Compatible  
con tarjetas  
SD



Compatible  
con tarjetas  
de memoria  
Multimedia



Compatible  
con tarjetas  
microSD



Para  
Android

### 406215. Lector imPORT OTG



24 en 1



Lector de  
tarjetas  
24 en 1



Compatible  
con tarjetas  
de memoria  
Multimedia



Compatible  
con tarjetas  
microSD



Para  
Android

### 406192. Adaptador imPORT OTG USB



1 puerto  
USB 2.0



Velocidad de  
transferencia:  
1.5/12/480 Mbps



Funciona con  
smartphones y tablets  
habilitados con  
tecnología OTG

### 406222. Adaptador OTG imPORT link con un puerto USB 2.0



24  
en 1



Lector de  
tarjetas  
24 en 1



Tasa de  
transferencia:  
480 Mbps



Funciona con  
smartphones y tablets  
habilitados con  
tecnología OTG



Para  
Android

### 406208. Lector Tarjetas OTG imPORT 24 en 1



24  
en 1

Lector de  
tarjetas  
24 en 1



Tasa de  
transferencia:  
480 Mbps



Funciona con  
smartphones y tablets  
habilitados con  
tecnología OTG



Para  
Android



 **manhattan**<sup>®</sup>  
Life just got easier.<sup>™</sup>

# ACCESORIOS Y PERIFÉRICOS

**180214. Cargador de energía – 60 W**

**NUEVO**



Carga para dos dispositivos con puerto USB-A



Carga para un dispositivo con puerto USB-C



Puerto USB-C PD para un máximo de 60 W para cargar una notebook, laptop, y más

**180054. Cargador de energía – 45 W**

**PRÓXIMAMENTE**



Carga para dos dispositivos con puerto USB-A



Carga para un dispositivo con puerto USB-C



Puerto USB-C PD para un máximo de 45 W para cargar una notebook, laptop, y más

**100854. Fuente de poder universal**



Salida de DC: 12 – 24 V; máximo 4 A; 70 W



Entrada de AC: 100 – 240 V; 47 – 63 Hz



Voltaje ajustable

**101622. Fuente de poder universal (mini)**



Salida de CD: 9,5 – 20 V; máximo 3,5 A; 40 W



Entrada de CA: 100 – 240 V; 50 – 60 Hz



Voltaje ajustable automático

**180009. Estación de carga con 10 puertos USB**



10 puertos frontales USB-A



Salida de 2.0 para carga rápida en su primer puerto



Salida de 1 A en los siguientes 5 puertos



Salida de 2.4 A en los últimos 4 puertos

**714778. Gabinete profesional para recarga de energía**



14 tomas AC para adaptadores de carga



Fabricado en acero, totalmente ensamblado y con espacio para almacenaje del cable de corriente



Repisas ajustables con divisiones removibles y organizador de cables integrado



**102186. Base de carga inalámbrica rápida - 10 W**

**PRÓXIMAMENTE**



Certificado Qi™ para garantizar una carga segura para ti y tus dispositivos



Hasta 10 W de carga rápida de dispositivos compatibles como teléfonos de Samsung, Apple®, LG, Sony



Tecnología de seguridad integrada que corta la salida de energía cuando se detecta metal

**102209. Base dual de carga inalámbrica - 30 W**

**PRÓXIMAMENTE**



Certificado Qi™ para garantizar una carga segura para ti y tus dispositivos



Dos bases de carga que admiten hasta 15 W para la carga súper rápida de dispositivos



Tecnología de seguridad integrada que corta la salida de energía cuando se detecta metal

**102216. Cargador inalámbrico rápido para automóvil - 10 W**

**PRÓXIMAMENTE**



Certificado Qi™ para garantizar una carga segura para ti y tus dispositivos



Hasta 10 W de carga rápida para teléfonos inteligentes de Samsung, Apple®, LG, Sony



Opción para instalar por medio de clip en las persianas de ventilación del automóvil o por ventosa

**101721. Cargador USB para Auto 2 puertos**



Salida de potencia USB: 5 V DC



1 puerto USB de 1 A



1 puerto USB de 2.1 A

**101714. Cargador USB de auto**



Para celular o tablet



1 puerto USB de 2.1 A

**101738. Cargador para dos puertos USB**



Permite la carga de dos dispositivos USB desde un contacto de pared



Carga a 1A por puerto con dos dispositivos conectados o a 2.1A con un dispositivo conectado

**164924. Conector múltiple de 4 puertos para USB 3.2 Gen 1**

**NUEVO**



4 puertos USB-A hembra



Conexión USB-C macho



USB 3.2 Gen 1

**164948. Conector múltiple de 3 puertos para USB 3.2 Gen 1 con lector de tarjetas**

**NUEVO**



3 puertos USB-A hembra



Lector de tarjetas



Conexión USB-C macho



USB 3.2 Gen 1

**164894. Conector múltiple de 4 puertos para USB 3.2 Gen 1**



2 puertos USB-A hembra



2 puertos USB-C hembra



Conexión USB-C macho



USB 3.2 Gen 1

**163552. Hub USB-C con puertos USB A y C**



3 puertos USB-A hembra



1 puerto USB-C hembra (PD)



Conexión USB-A macho



USB 3.1 Gen 1

**162746. Hub USB - USB Tipo-C**



4 puertos USB-A hembra



Conexión USB-C macho



USB 3.1 Gen 1

**162463. Hub USB - USB Tipo-C**



13 puertos USB-A hembra



Conexión USB-A macho



USB 2.0



Adaptador de corriente

**164887. Conector múltiple de 4 puertos para USB 3.2 Gen 1**

**NUEVO**



2 puertos USB-A hembra



2 puertos USB-C hembra



Conexión USB-A macho



USB 3.2 Gen 1

**164900. Conector múltiple de 4 puertos para USB 3.2 Gen 1**

**NUEVO**



4 puertos USB-A hembra



Conexión USB-A macho



USB 3.2 Gen 1

**164955. Conector múltiple de 4 puertos para USB 3.2 Gen 1 con adaptador de alimentación**

**PRÓXIMAMENTE**



4 puertos USB-A hembra



Conexión USB-micro hembra a USB-A macho



USB 3.2 Gen 1



Adaptador de corriente 5V/2A

**164931. Conector múltiple de 3 puertos para USB 3.2 Gen 1 con lector de tarjetas**

**NUEVO**



3 puertos USB-A hembra



Lector de tarjetas



Conexión USB-A macho



USB 3.2 Gen 1

**161411. Hub industrial USB 3.0 de 4 puertos**



4 puertos USB-A hembra



Conexión USB-B macho a USB-A



USB 3.0



Alimentación CA

**163767. Hub USB 3.0 de 4 Puertos**



4 puertos USB-A hembra



Conexión USB-A macho



USB 3.0

**162296. Hub USB de Supervelocidad**



4 puertos USB-A hembra



Conexión USB-A macho



USB 3.0

**163590. Hub USB 3.0 y Lector/Grabador de Tarjetas**



3 puertos USB-A hembra



Lector de tarjetas



Conexión USB-A macho



USB 3.0

**163828. Hub combo USB 3.0 / 2.0**



3 puertos USB-A 2.0 hembra



1 puerto USB-A 3.0 hembra



Conexión USB-A macho



USB 2.0 / 3.0

**161572. Hub USB**



10 puertos USB-A hembra



Conexión USB-A macho



USB 2.0



Adaptador de corriente

**161169. Mini hub USB de alta velocidad**



7 puertos USB-A hembra



Conexión USB-A macho



USB 2.0

**161039. Hub USB**



7 puertos USB-A hembra



Conexión USB-A macho







USB 2.0



Adaptador de corriente





◆161053. Hub USB



			
4 puertos USB-A hembra	Conexión USB-A macho	USB 2.0	Tasas de transferencia: 1.5/12/480 Mbps

160612. Hub USB



			
4 puertos USB-A hembra	Conexión USB-A macho	USB 2.0	Adaptador de corriente





◆160599. Mini hub USB



		
4 puertos USB-A hembra	Conexión USB-A macho	USB 2.0

◆162272. Mini hub USB



			
4 puertos USB-A hembra	Conexión USB-A macho	USB 1.1	Velocidad de transmisión: 12 Mbps

◆160605. Micro hub USB



		
4 puertos USB-A hembra	Conexión USB-A macho	USB 2.0

101998. Lector de tarjetas 79 en 1, USB 2.0



<b>79 en 1</b>		
Compatible con 79 formatos de tarjetas	1 puerto USB 2.0 de alta velocidad	Tasa de transferencia: 480 Mbps

**101653. Lector y grabador externo de tarjetas 62 en 1**



**62 en 1**

Compatible con 62 formatos de tarjetas



Compatible con tarjetas SD



Compatible con tarjetas de memoria Multimedia



Compatible con tarjetas microSD



Tasa de transferencia: Hasta 5 Gbps

**100939. Lector Tarjetas USB 2.0, 60 en 1**



**60 en 1**

Compatible con 60 formatos de tarjetas



1 puerto USB 2.0 de alta velocidad



Tasa de transferencia: 480 Mbps

**102018. Lector Tarjetas USB + USB-C 2.0, 24 en 1**



**24 en 1**

Compatible con 24 formatos de tarjetas



Compatible con tarjetas SD



Compatible con tarjetas de memoria Multimedia



Compatible con tarjetas microSD



Tasa de transferencia: Hasta 480 Mbps

**101981. Mini Lector y grabador externo de tarjetas. 24 en 1**



**24 en 1**

Compatible con 24 formatos de tarjetas



Compatible con tarjetas SD



Compatible con tarjetas de memoria Multimedia



Compatible con tarjetas microSD



Tasa de transferencia: Hasta 5 Gbps

**101677. Mini lector y grabador externo de tarjetas. 24 en 1**



**24 en 1**

Compatible con 24 formatos de tarjetas



1 puerto USB 2.0



Tasa de transferencia: 480 Mbps

**102001. Lector Tarjetas USB-C 2.0, 24 en 1**



**24 en 1**

Compatible con 24 formatos de tarjetas



Tasa de transferencia: Hasta 480 Mbps



Compatible con tarjetas SD



Compatible con tarjetas de memoria Multimedia



Compatible con tarjetas microSD

**176071. Ratón óptico para videojuegos**



Conexión  
USB 2.0



Seis botones  
con rueda de  
desplazamiento



Iluminación  
LED



Forma  
ergonómica

**Mouse Óptico Gaming c/luz**

**179232. Blanco**    **179164. Negro**



Conexión  
USB



Seis botones  
con rueda de  
desplazamiento



Luz led,  
blanca



Forma  
ergonómica

**178457. Teclado gaming — Edición Base Metálica**



A prueba de  
salpicaduras



Retroilumi-  
nación LED  
constante



12 teclas con  
acceso  
multimedia



19 teclas anti  
efecto fantasma

**176088. Audífonos USB para videojuegos, con luces LED**



Longitud:  
1.8 m



Plug  
3.5 mm



Función de  
control de audio



Compatible con  
chats en vivo

**178464. Juego de teclado y mouse óptico, cableados**



Conexión  
USB 1.0



Ratón con tres botones  
con rueda de  
desplazamiento



Teclado con diseño  
ergonómico y con  
amplia área de trabajo

**◆ 176354. Teclado numérico**



Conexión  
USB 1.1



18 teclas, incluye tecla  
de retroceso



Ultra delgado  
y ligero

**177795. Mouse Inal. Óptico de alto rendimiento**



Conexión inalámbrica:  
Hasta 10 m



Administración automática de la energía



Forma ergonómica

**179416. Mouse Inal. Óptico "Success" Negro/Azul**



Conexión inalámbrica:  
Hasta 10 m



Administración automática de la energía



Forma ergonómica

**Ratón óptico USB Edge**

**179423. Gris [1] 177801. Azul [2] 179430. Rojo [3]**



Conexión USB



Tamaño compacto, ergonómico y diseño ambidiestro

**◆ 177627. Mouse "silueta" tipo Mac, económico**



Conexión USB 1.0



Tres botones con rueda de desplazamiento



Forma ergonómica

**◆ 177658. Mouse "silueta" tipo Mac, económico**



Conexión USB 1.0



Tres botones con rueda de desplazamiento



Forma ergonómica

**Mouse Económico USB, Bolsa**

**178402. Negro 178815. Blanco**



Conexión USB 1.0



Tres botones con rueda de desplazamiento



Forma ergonómica



**Mousepad con descansa muñeca tipo gel**

◆ 434362. Negro ◆ 434386. Azul



Soporte suave para la muñeca con sensación como de gel



Diseñado ergonómicamente, combate la fatiga

**422871. Mousepad 3 en 1, microfibra**



Tamaño aproximado:  
225 x 170 x 1 mm



Microfibra suave, limpia el polvo, quita el brillo y las manchas

**Mousepad 6 mm, en bolsa**

◆ 423533. Bolsa ◆ 423526. Granel



Espuma: 6mm

**175555. Audífonos clásico**



Plug  
3.5 mm



Función de  
control de audio



Stereo



Micrófono

**175517. Audífonos Estéreo**



Longitud:  
2.5 m



Plug  
3.5 mm



Stereo



Micrófono

**◆ 164429. Audífonos estándar**



Longitud:  
1.8 m



Plug  
3.5 mm



Función de  
control de audio



Micrófono

**177481. Audífonos Estéreo**



Longitud:  
2.2 m



Plug  
3.5 mm



Stereo



Diadema ligera  
ajustable

**178297. Audífonos Intraauricular LS Canto de Sol**



Longitud:  
1.2 m



Stereo  
3.5 mm

**439909. Maletín para Computadora Portátil - "London"**

**NUEVO**



Exterior:  
45 x 33 x 8.5 cm



Interior:  
44 x 32 x 7.5 cm



Peso:  
430 g



Compartimiento  
para laptop de  
hasta 17.3"

**◆ 438889. Maletín London**



Exterior:  
41 x 31 x 7 cm



Interior:  
39 x 29 x 5 cm



Peso:  
390 g



Compartimiento  
para laptop de  
hasta 15.6"

**439893. Maletín para Computadora Portátil - "London"**

**NUEVO**



Exterior:  
37 x 29 x 6.5 cm



Interior:  
36 x 28 x 5.5 cm



Peso:  
350 g



Compartimiento  
para laptop de  
hasta 14.1"

**439862. Maletín para Computadora Portátil - "London"**

**NUEVO**



Exterior:  
33 x 27 x 5.8 cm



Interior:  
32 x 26 x 4.8 cm



Peso:  
330 g



Compartimiento  
para laptop de  
hasta 12.5"

### 421560. Maletín Empire



Exterior:  
43 x 33 x 8 cm



Interior:  
42 x 32 x 6.5 cm



Peso:  
993 g



Compartimiento  
para laptop de  
hasta 17.0"

### 421430. Maletín Times Square



Exterior:  
29 x 37 x 6 cm



Interior:  
28 x 37 x 5 cm



Peso:  
850 g



Compartimiento  
para laptop de  
hasta 15.4"

### 439831. Maletín backpack 15.6" negra



Exterior:  
48.5 x 33 x 19.5 cm



Compartimiento  
de computadora:  
37 x 28.5 x 5 cm



Peso:  
Hasta 10 kg



Compartimiento  
para laptop de  
hasta 15.6"

### Maletín Backpack 12" Dashpack

439855. Negro/Azul 439879. Negro/Rosa

ÚLTIMAS  
PIEZAS



Exterior:  
44 x 31 x 9 cm



Compartimiento  
de computadora:  
29.7 x 20.9 x 1.4 cm



Peso:  
440 g



Almacenan  
tablets/ ultrabooks  
de hasta 12"

### 440295. Candado de Seguridad Wedge N17 para Portátiles



PRÓXIMAMENTE



Longitud:  
2.0 m



Cable de acero resistente  
y sólido, construcción  
completamente metálica

### 440240. Candado de seguridad para computadoras portátiles de llave



Longitud:  
1.8 m



Cable de acero resistente  
y sólido, construcción  
completamente metálica

◆ 440271. Candado de seguridad



Longitud:  
1.4 m



Cable de acero resistente  
y sólido, construcción  
completamente metálica

700467. Base con ventilador para computadora portátil

ÚLTIMAS PIEZAS



3 ventiladores silenciosos



Ayuda a reducir la temperatura  
de operación

130479. Gabinete QuickDock HDD-2 SATA-USB 3.0



2 ranuras SATA



Acepta unidades de  
disco duro de 3.5" y 2.5"



Capacidad por disco:  
3 TB

130356. Gabinete Quick Port, discos duros SATA de 3.5" y 2.5", USB 3.0



1 ranura SATA



Acepta unidades de  
disco duro de 3.5" y 2.5"



Tasa de transferencia:  
Hasta 5 Gbps

151955. Gabinete QuickDock HDD\*2 SATA-USB 3.0



NUEVO



2 ranuras SATA



Acepta unidades de  
disco duro de 2.5"



conexión de discos duros  
SATA 2.5" de hasta 6 TB

130455. Gabinete de USB SúperVelocidad a M.2 NGFF para Disco de Estado Sólido (SSD)



Conexión  
USB 3.1



Tasa de transferencia:  
Hasta 5 Gbps



Acepta los discos  
de estado sólido  
más comunes

**Gabinete para disco duro SATA 2.5",  
conexión USB 2.0, silicón**

130103. Negro    130110. Azul

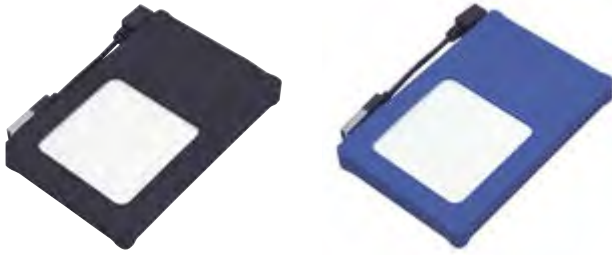

1 puerto  
USB 2.0



Permite la  
ventilación



Proporciona un  
ajuste amortiguador

**130042. Gabinete para disco duro SATA 2.5",  
conexión USB 2.0**



1 puerto  
USB 2.0



Chasis  
resistente



Instalación fácil  
y rápida

**130349. Gabinete para disco duro SATA 2.5",  
conexión USB 3.0**



1 puerto  
USB 3.0



Tasa de transferencia:  
Hasta 5 Gbps



Almacenamiento:  
Hasta 1 TB

**530071. Kit técnico de herramientas**



17 piezas



Uso pesado



Transportadora  
con cierre

**400077. Kit de herramientas para mantenimiento PC**



11 piezas



Uso rudo



Maletín de  
transportación

**530217. Kit universal de herramientas**



145 piezas



Caja para carga pesada

◆ 161138. Barra multicontacto



6 contactos  
de 125 V AC



Carga máxima  
de 1875 W



Switch de encendido  
y apagado con  
cortacircuitos y botón  
de reestablecimiento

◆ 410144. Pulsera antiestática



Cable:  
1.8 m



Pulsera  
ajustable

◆ 410632. Removedor de polvo



Bote con  
236 ml



Incluye popote  
de extensión



Remueve de manera segura  
el polvo y la suciedad de  
equipo electrónico

◆ 421010. Kit de limpieza con brocha y microfibra



Solución de  
limpieza: 60 ml



Paño de microfibra:  
20 x 19 cm



Brocha suave que  
elimina el exceso  
de polvo y manchas

◆ 421027. Kit de limpieza con brocha y microfibra



Solución de  
limpieza:  
200 ml



Paño de  
microfibra:  
30 x 30 cm



Brocha suave que  
elimina el exceso de  
polvo y manchas

◆ 433105C. Paños húmedos para monitores



50 hojas  
desechables  
15 x 11.5 cm



Remueve el polvo de  
pantallas planas, CD/  
DVD y electrónicos



Sin abrasivos,  
fórmula segura limpia  
sin rayaduras

◆432528. Batería para motherboard, 3 V, modelo CR2032, 2 piezas



Proporciona una potencia de 3 V



Tecnología de celdas de litio

2

Paquete con 2 baterías

Pasta térmica jeringa

◆701662. 1.5 g

◆140065. 20.0 g



Ayuda a disipar el calor



Dispensador de jeringa con tapa

170598. Convertidor de dispositivos IDE a SATA 150



Tasa de transferencia: Hasta 1.5 Gbps

IDE

100% compatibles con todos los dispositivos IDE

152129. Convertidor SATA 150 a IDE



Tasa de transferencia: Hasta 1.5 Gbps

SATA-IDE

Conecta fácilmente dispositivos SATA a conexiones IDE

◆700320. Ventilador 80 x 80 x 25 mm, conector 4 pines para gabinete, tipo sleeve

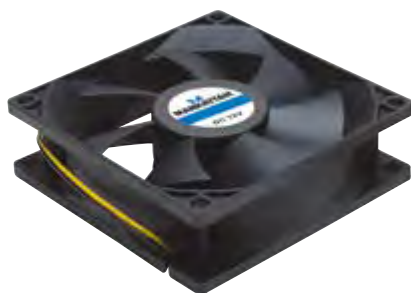

Frente: 80 mm



Altura: 25 mm



Profundidad: 80 mm



Velocidad del ventilador: 2.500 rpm

◆700955. Ventilador 80 x 80 x 25 mm, conector 3 pines para gabinete, tipo sleeve



Frente: 80 mm



Altura: 25 mm



Profundidad: 80 mm



Velocidad del ventilador: 2.500 rpm

**101967. Lector/Grabador de múltiples tarjetas**



Para bahía de montaje de 3.5"



Tasa de transferencia: Hasta 5 Gbps

**48 en 1**

Compatible con hasta 48 tipos de formatos

**101974. Lector/Grabador de múltiples tarjetas**



Para bahía de montaje de 3.5"



Tasa de transferencia: Hasta 5 Gbps

**34 en 1**

Compatible con hasta 34 tipos de formatos

**151757. Tarjeta PCI Express USB-C 3.1**



1 puerto USB-A



1 puerto USB-C



Soporta ranura PCI Express

**151795. Tarjeta PCI Express USB 3.1**



2 puertos USB 3.1 de súper alta velocidad+



Soporta ranura PCI Express

**152884. Tarjeta PCI Express USB 3.0**

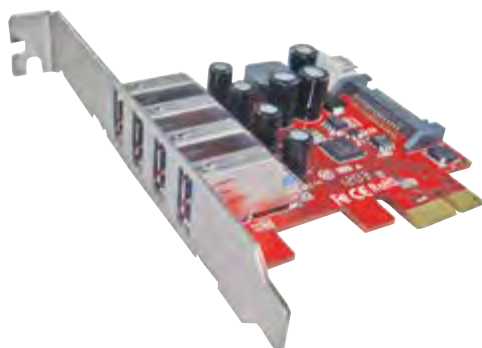

Tarjeta USB 3.0



4 puertos USB



Soporta ranura PCI Express

**152891. Tarjeta PCI express USB 3.0**



Tarjeta USB 3.0



4 puertos USB



Soporta ranura PCI Express



**171557. Tarjeta PCI USB 2.0**



Tarjeta USB 2.0



4 puertos USB



Soporta ranura PCI

**151375. Tarjeta USB de Súper Velocidad 3.0**



Tarjeta USB 3.0



2 puertos USB de súper velocidad



Soporta ranura PCI Express

**152105. Tarjeta Serial**



Tarjeta serial



Añade 4 puertos serie DB9 de alta velocidad



Soporta ranura PCI Express

**175586. Tarjeta serial**



Tarjeta serial



Añade 4 puertos serie DB9 de alta velocidad



Soporta ranura PCI

**152082. Tarjeta serial**

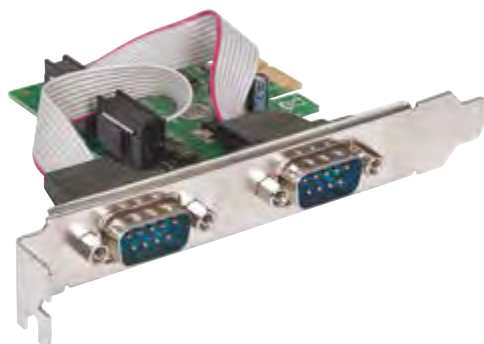

Tarjeta serial



2 puertos externos serie DB9



Soporta ranura PCI Express

**158152. Tarjeta serial**



Tarjeta serial



1 puerto externo DB9



Soporta ranura PCI Express

**158213. Tarjeta serial**



Tarjeta serial



2 puertos externos serie DB9



Soporta ranura PCI

**158251. Tarjeta PCI Combo Serie/Paralelo**



Tarjeta serie/paralelo



1 puerto paralelo DB25



2 puertos externos serie DB9



Soporta ranura PCI

**152099. Tarjeta paralela**



Tarjeta paralela



1 puerto paralelo DB25



Soporta ranura PCI Express

**158220. Tarjeta paralela**



Tarjeta paralela



1 puerto externo DB25



Soporta ranura PCI

**102032. Lector Tarjetas Inteligentes + SIM (c/chip)**



Conexión USB 2.0



Compatible con tarjetas smart/SIM con contacto de fricción



Ideal para transacciones y aplicaciones que requieren intercambios seguros de información

**460255. Lector de Banda Magnética de Tarjetas**



Conexión USB



Lector de banda magnética de triple pista

**177603. Lector de código de barras 2D alcance 43 cm**



200 escaneos por segundo



Rango de lectura: 43 cm



Acepta códigos 2D y 1D



Interfaz: USB

**178495. Lector inalámbrico de códigos de barras**



500 escaneos por segundo



Rango de lectura: 50 cm



Bluetooth: Hasta 80 m



Detecta los códigos de barras más comunes

**460866. Lector de códigos de barras**



200 escaneos por segundo



Rango de lectura: 10 cm



Interfaz: USB

**178433. Lector de códigos de barras**



500 escaneos por segundo



Rango de lectura: 50 cm



Detecta los códigos de barras más comunes



Interfaz: USB

**177672. Lector de código barras de largo alcance**



500 escaneos por segundo



Rango de lectura: 50 cm



Detecta los códigos de barras más comunes



Interfaz: USB

**401517. Lector de códigos barras**



120 escaneos por segundo



Rango de lectura: 20 mm



Campo de escaneo: 80 mm



Interfaz: USB

**460835. Lector de código de barras**



500 escaneos por segundo



Rango de lectura: 50 cm



Interfaz: USB

**178488. Lector de códigos de barras**



100 escaneos por segundo



Rango de lectura: 60 mm



Campo de escaneo: 60 mm



Interfaz: USB

**177665. Lector láser de código de barras**



50 escaneos por segundo



Rango de lectura: 300 mm



Interfaz: USB

**460842. Soporte para lectores de códigos de barras**



Altura máxima: 26 cm



Para poner sobre la mesa, el mostrador o montarse en la pared



Compatible con los modelos de lectores 178495, 460835 y 177603

**551496. HomeCam. Cámara para la vigilancia de tu hogar**

**ÚLTIMAS PIEZAS**



Vinculable mediante app a smartphones y tablets



Conexión inalámbrica a red



Control de rotación desde tu dispositivo móvil



Sensor de movimiento

**551502. PetCam. Cámara para vigilar a tus mascotas**

**ÚLTIMAS PIEZAS**



Vinculable mediante app a smartphones y tablets



Conexión inalámbrica a red



Control de rotación desde tu dispositivo móvil



Sensor de movimiento







Manhattan® ofrece soluciones profesionales de conectividad, con línea completa de cables, adaptadores, convertidores, soportes y dispositivo de video.

Tu negocio crece con Manhattan® porque tenemos para ti: precio, garantía y calidad con las mejores condiciones del mercado, ofreciéndote la oportunidad de tener mejores utilidades.

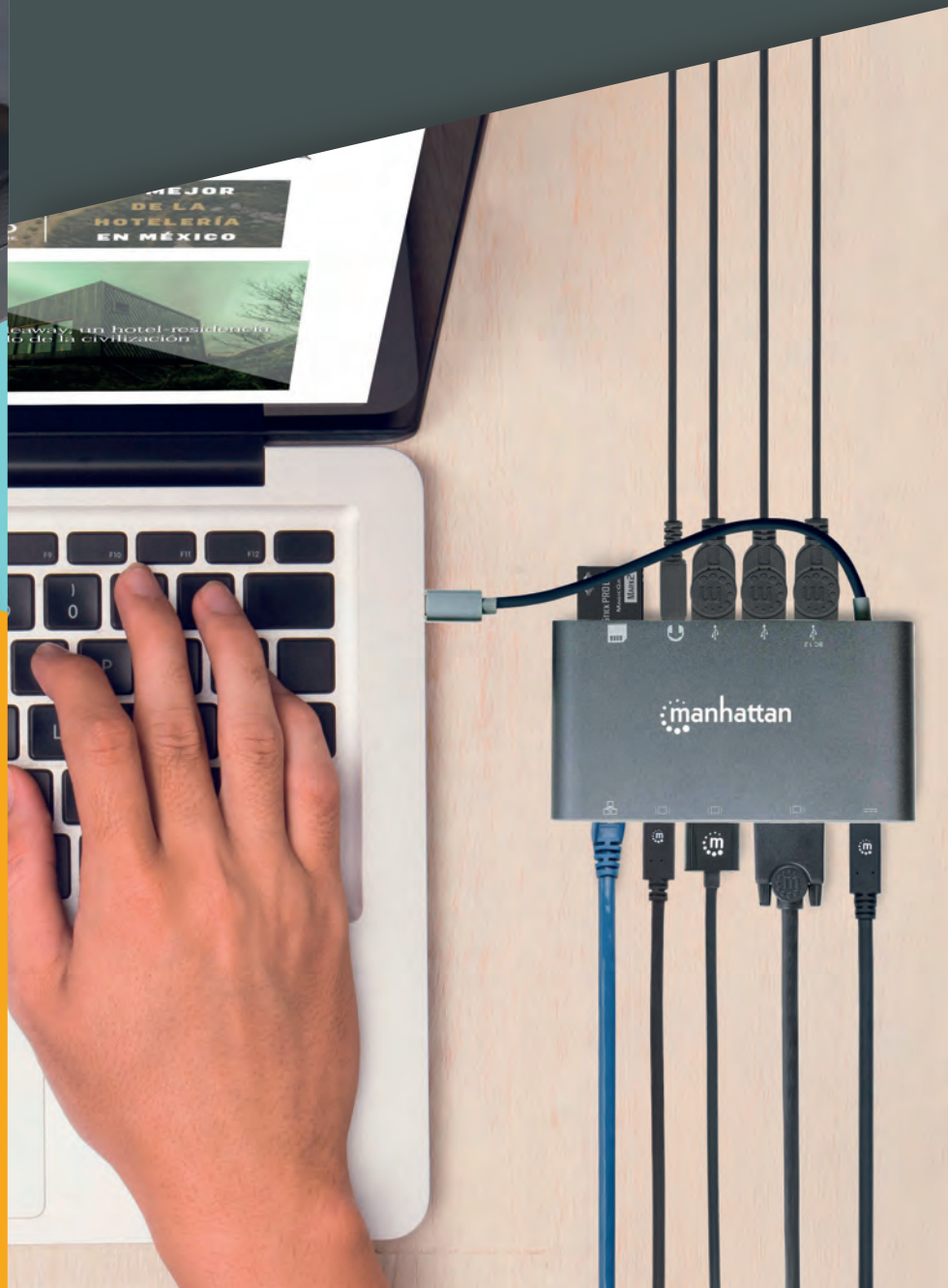

# SIN LÍMITES PARA TRABAJAR!

**manhattan**  
Life just got easier.



Manhattan® crece al ritmo de la tecnología y se adapta a los diversos dispositivos que cuentan solo con entradas USB tipo C.

Con nuestra Estación Docking 7 en 1 de SuperVelocidad podrás conectar desde teclados y audífonos hasta tarjetas de memoria y monitores.



Modelo: 152808

**PARA ADQUIRIR NUESTROS PRODUCTOS,  
CONTACTE CON NUESTROS MAYORISTAS Y DISTRIBUIDORES**



[www.intellinetsolutions.mx](http://www.intellinetsolutions.mx)



[www.manhattanproducts.mx](http://www.manhattanproducts.mx)