

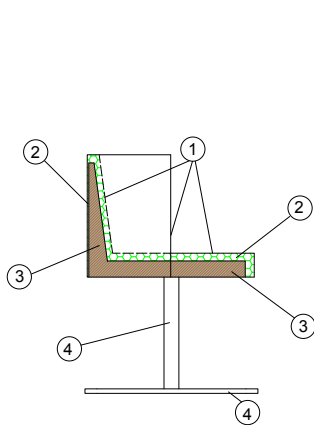

Tigram: the art of playing with geometrical shapes (and turning them into sofas and chairs)

Starting out from Tangram, the ancient Chinese game based on arranging seven geometrical shapes in combinations to form an endless variety of designs and figures, Adrenalina has developed a collection of padded elements that re-invents the original brain teaser. The seven basic elements are armchairs, sofas, poufs and stools, all rigorously modeled on a hexagonal base and featuring different sizes, heights, and colours, which can be combined and separated to create figures and symbols in a kaleidoscope of variations. The simple shapes of Tigram's primary elements allow a tremendous and exciting variety of combinations that give birth to complex clusters of figures that can be freely interpreted both by those who arrange them and by the observer.

The choice of single elements can be summed up in a harmonic yet explosive whole, but you can also let them drift away from each other and let them recover their individual charm. Tigram can be an articulated combination of elements, but each element can also elegantly stand on its own to stylize a corner or to fashion a cozy and friendly parlour.



TIGRAM CHAIR:

- 1 - dacron® fiber 100 gr;
- 2 - high resilience polyurethane foam of different densities;
- 3 - structural frame in plywood;
- 4 - swivel base in shiny inox and column in chrome metal.

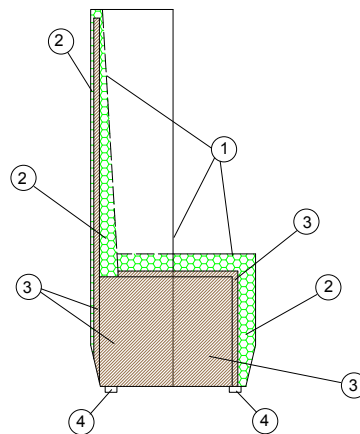

TIGRAM LOW-HIGH:

- 1 - dacron® fiber 100 gr;
- 2 - high resilience polyurethane foam of different densities;
- 3 - structural frame in plywood;
- 4 - PVC feet.

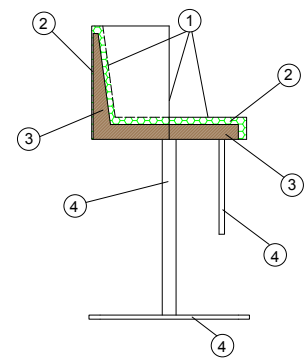

TIGRAM STOOL:

- 1 - dacron® fiber 100 gr;
- 2 - high resilience polyurethane foam of different densities;
- 3 - structural frame in plywood;
- 4 - swivel base in shiny inox and column in chrome metal.

11M

DESIGN ITALO PERTICHINI

TIGRAM

DIMENSIONS:

Low

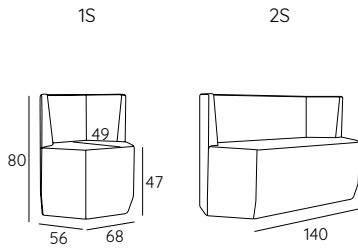

High

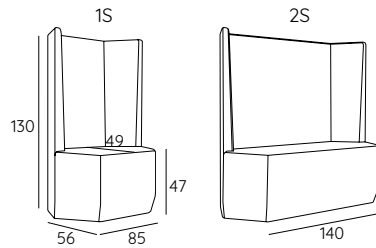

Chair

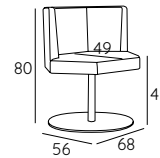

Stool

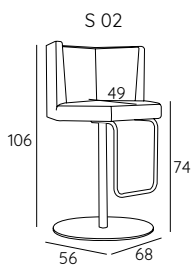

Pouf

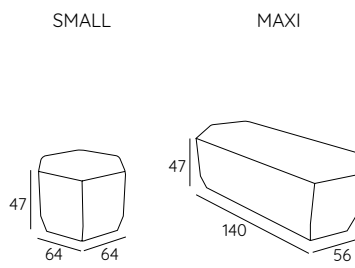

FEET AND BASES:

Low e High



Chair



Stool



Pouf



METAL BASES FINISHINGS:

DI SERIE

chrome
matt/shiny



plated brass
shiny



aged brass
brushed



black nickel
shiny



gold
matt/shiny



bronze-brass
matt/shiny

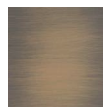

copper bronze
semigloss

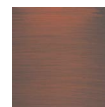

copper
matt/shiny

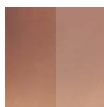

OPTIONAL

RAL on
demand

TECHNICAL DETAILS:

Removable cover: NO	kg	m ³	mts		kg	m ³	mts
TIGRAM LOW 1S	20	0.30	2.80	TIGRAM STOOL S 02	32	0.40	2.80
TIGRAM LOW 2S	39	0.63	4.00	TIGRAM STOOL S 03	25	0.40	2.80
TIGRAM HIGH 1S	34	0.62	3.80	TIGRAM POUF SMALL	13	0.19	1.20
TIGRAM HIGH 2S	48	1.02	5.00	TIGRAM POUF MAXI	30	0.37	2.80
TIGRAM CHAIR	24	0.30	2.80				

<https://adrenalina.it/tigram/>

adrenalina
WE ARE DIFFERENT!

11M

DESIGN ITALO PERTICHINI

TIGRAM

SUGGESTED CONFIGURATIONS:

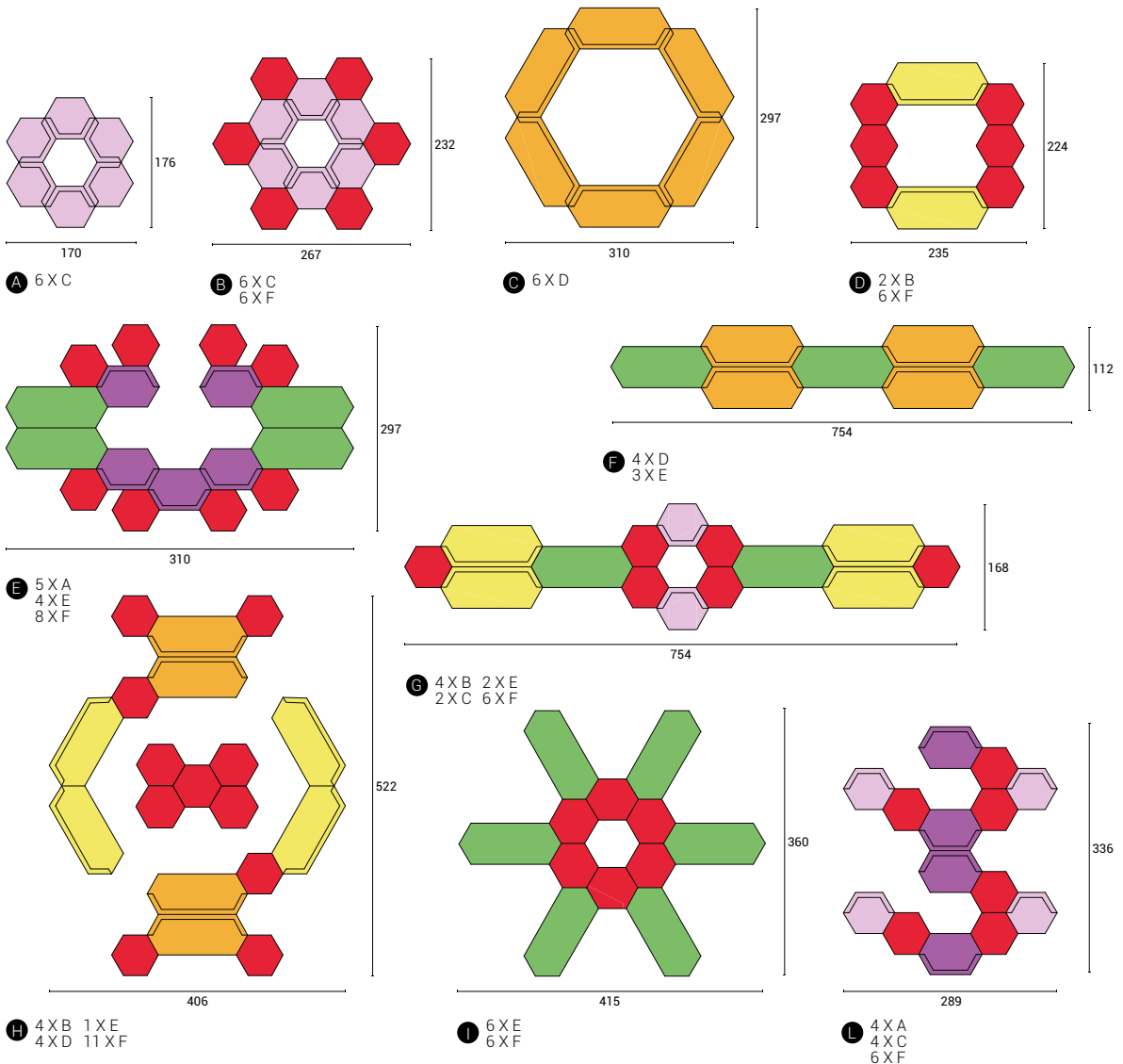
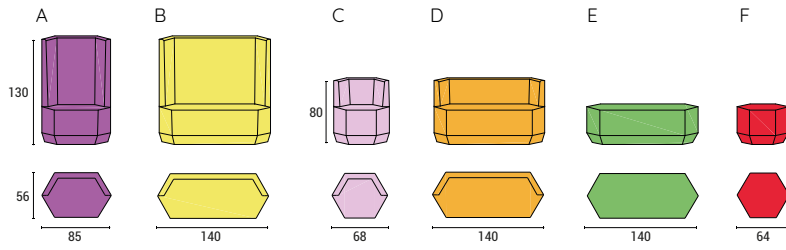

11M

DESIGN ITALO PERTICHINI

TIGRAM

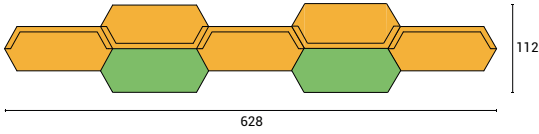

M 5XD
2XE

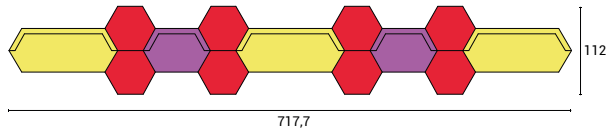

N 2XA
3XB
8XF

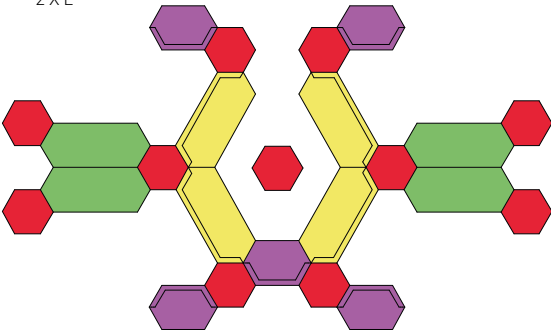

O 5XA 4XE
4XB 11XF

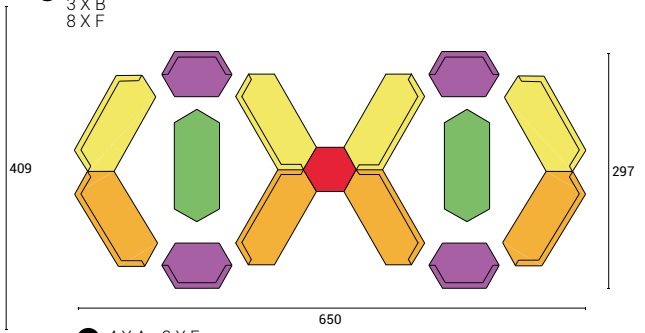

P 4XA 2XE
4XB 1XF
4XD

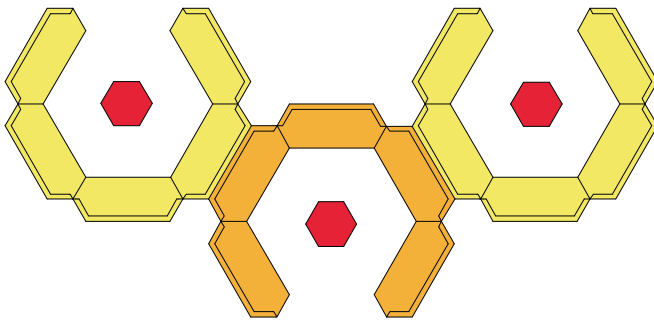

Q 10XB
5XD
3XF

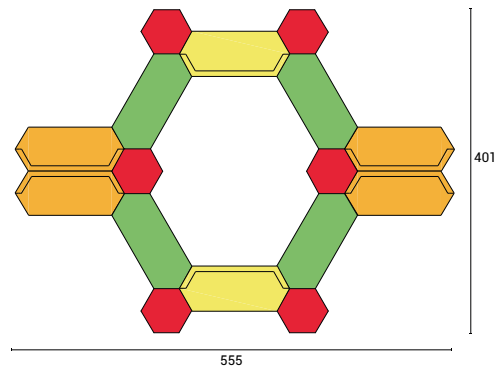

R 12XB
6XD
3XF

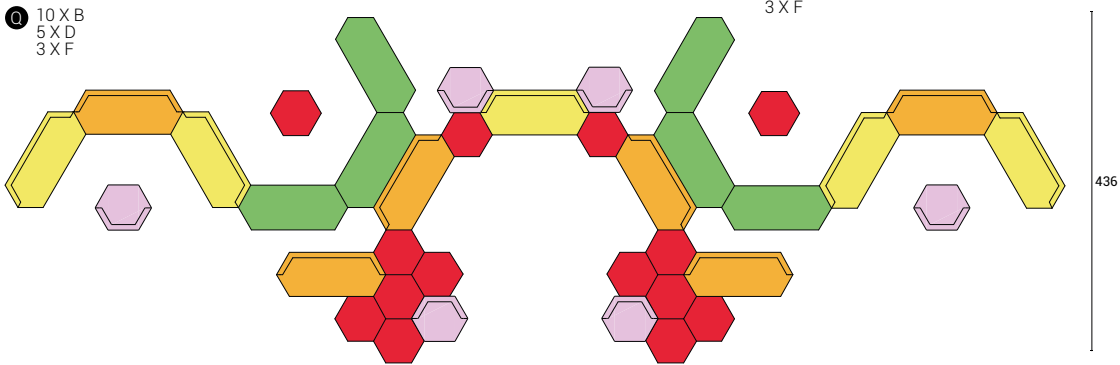

S 5XB 6XE
6XC 14XF
6XD

11M

DESIGN ITALO PERTICHINI

TIGRAM

SUGGESTED FABRICS:



PHOTO GALLERY:



Tigram low armchair



Tigram low sofa



Tigram high armchair



Tigram high sofa



Tigram chair



Tigram pouf small e maxi

<https://adrenalina.it/tigram/>

adrenalina
WE ARE DIFFERENT!



Tigram: l'arte di giocare con le forme geometriche e trasformarle in divani e poltrone.

Partendo dal concetto del Tangram, antico gioco cinese basato sulla componibilità di 7 forme geometriche con le quali si possono costruire infiniti disegni e figure, Tigram si sviluppa sulla base di forme geometriche semplici, su elementi primari componibili che le permettono di trasformarsi in un insieme complesso di figure liberamente interpretabili sia per chi le progetta, sia per chi le osserva. 7 elementi tra poltrone, divani, pouf e sgabelli, tutti rigorosamente modellati su una base esagonale, con diverse dimensioni ed altezze, disponibili in un'ampia varietà di colori, si uniscono e si separano creando figure e simboli e cromie mutanti come in un caleidoscopio. È una collezione perfetta per arredare locali pubblici che hanno la necessità di arredi flessibili e modulari, facilmente adattabili ai diversi momenti di vita dei luoghi vissuti da collettività in movimento, che mutano continuamente l'ambiente in cui si spostano. Tigram non è solo un insieme articolato, ma anche un singolo pezzo scelto ad hoc per un corner sofisticato o un angolo chiacchiere esclusivo di un ambiente domestico frutto di ricerca e studio, nel quale Tigram si inserisce nella versione con schienale basso, nel ruolo di divanetto discreto o di trono altezzoso.

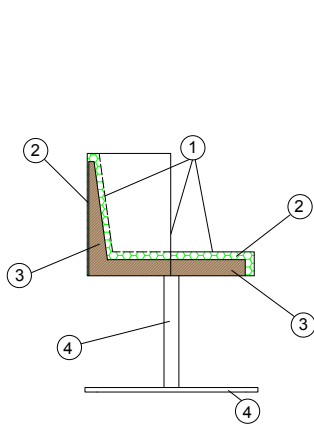

TIGRAM CHAIR:

- 1 - fibra di dacron® 100 gr;
- 2 - poliuretano espanso indeformabile di diverse densità;
- 3 - telaio in multistrato di legno;
- 4 - base girevole in inox lucido e colonna in metallo cromato.

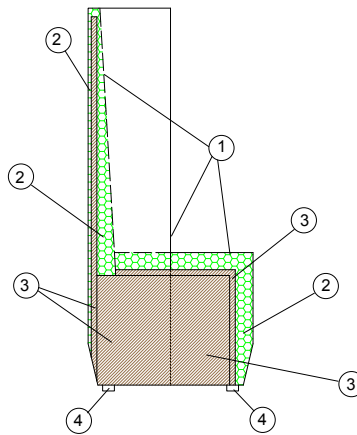

TIGRAM LOW-HIGH:

- 1 - fibra di dacron® 100 gr;
- 2 - poliuretano espanso indeformabile di diverse densità;
- 3 - telaio in multistrato di legno;
- 4 - piedi in PVC.

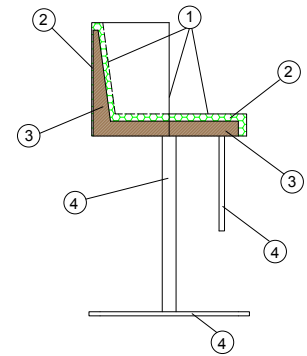

TIGRAM STOOL:

- 1 - fibra di dacron® 100 gr;
- 2 - poliuretano espanso indeformabile di diverse densità;
- 3 - telaio in multistrato di legno;
- 4 - base girevole in inox lucido e colonna in metallo cromato.

11M

DESIGN ITALO PERTICHINI

TIGRAM

DIMENSIONI:

Low

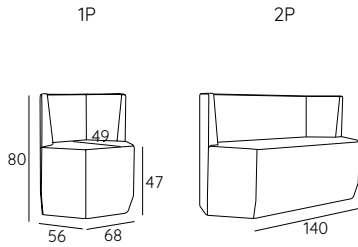

High

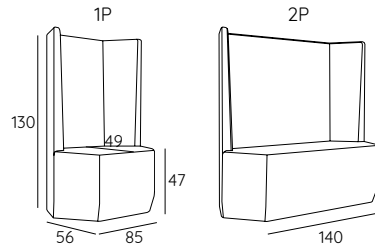

Chair

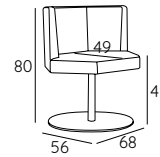

Stool

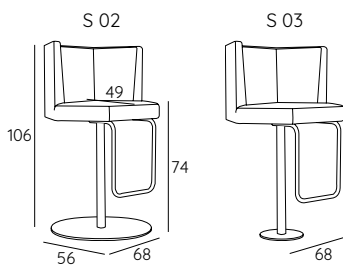

Pouf

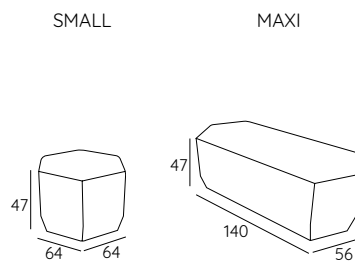

PIEDIE BASI:

Low e High



Chair



Stool

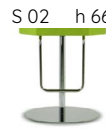

Pouf



FINITURE METALLO BASI:

DI SERIE

Cromo satinato/lucido

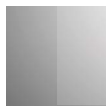

Ottone lucido



Ottone brunito satinato



Canna di fucile lucido

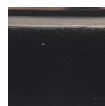

Oro opaco/lucido



Bronzo ottone semilucido



Bronzo rame semilucido

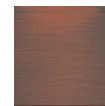

Rame opaco/lucido



OPTIONAL

RAL su richiesta

INFORMAZIONI TECNICHE:

Sfoderabile: NO	kg	m ³	mts		kg	m ³	mts
TIGRAM LOW 1P	20	0.30	2.80	TIGRAM STOOL S 02	32	0.40	2.80
TIGRAM LOW 2P	39	0.63	4.00	TIGRAM STOOL S 03	25	0.40	2.80
TIGRAM HIGH 1P	34	0.62	3.80	TIGRAM POUF SMALL	13	0.19	1.20
TIGRAM HIGH 2P	48	1.02	5.00	TIGRAM POUF MAXI	30	0.37	2.80
TIGRAM CHAIR	24	0.30	2.80				

<https://adrenalina.it/tigram/>

adrenalina
WE ARE DIFFERENT!

11M

DESIGN ITALO PERTICHINI

TIGRAM

COMBINAZIONI SUGGERITE:

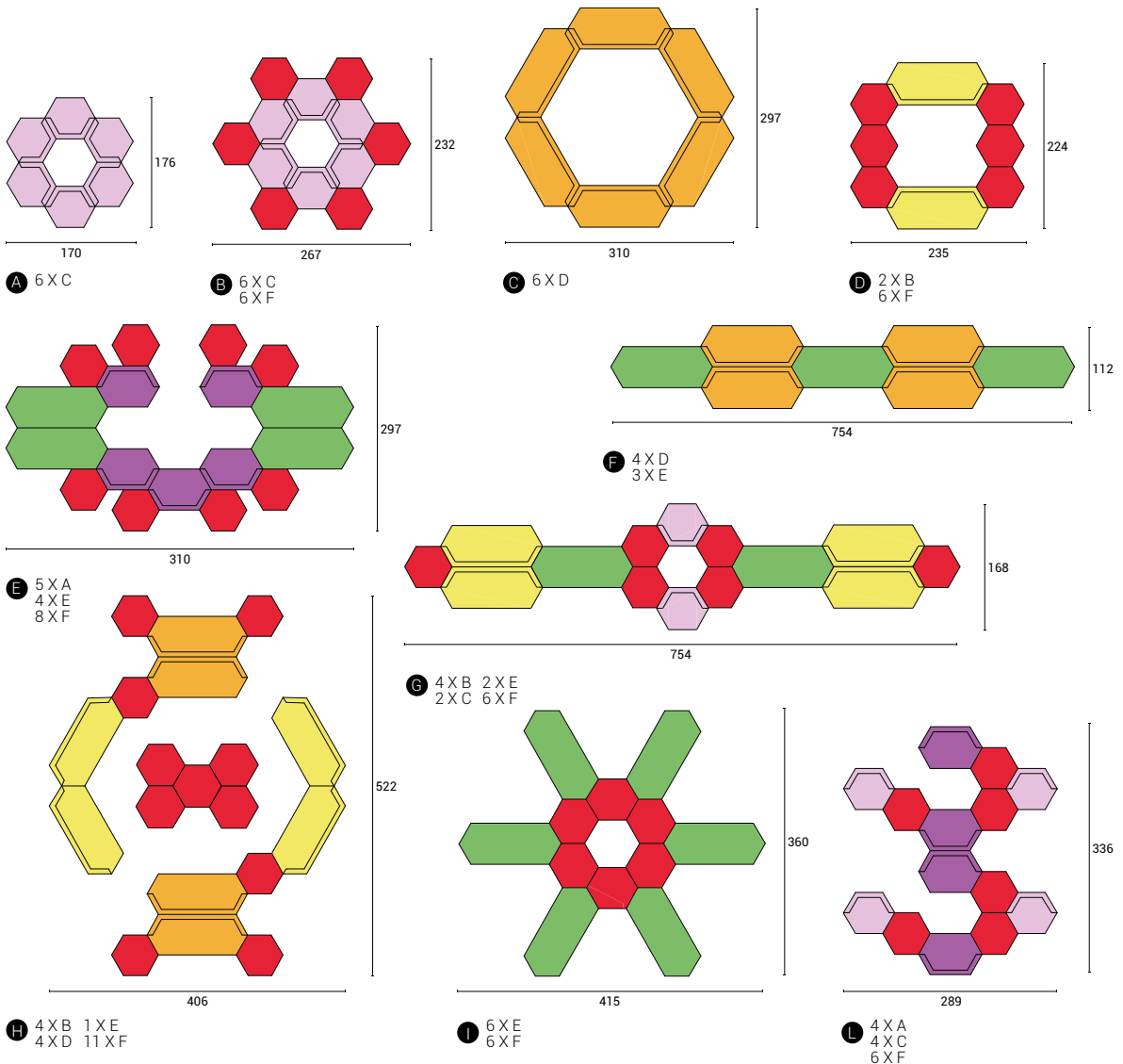
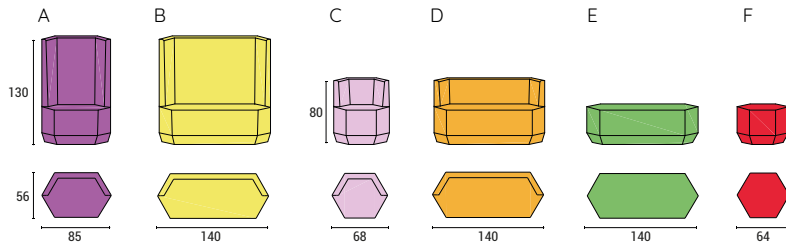

11M

DESIGN ITALO PERTICHINI

TIGRAM

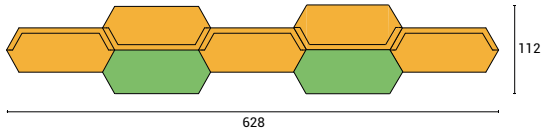

M 5 X D
2 X E

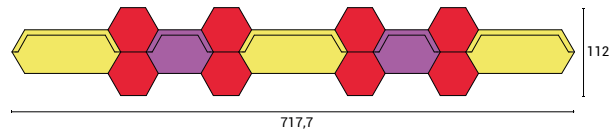

N 2 X A
3 X B
8 X F

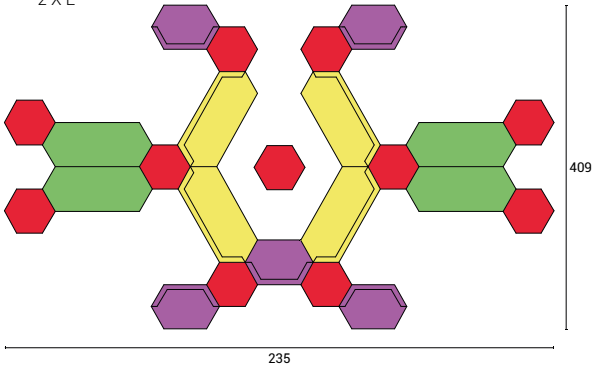

O 5 X A 4 X E
4 X B 11 X F

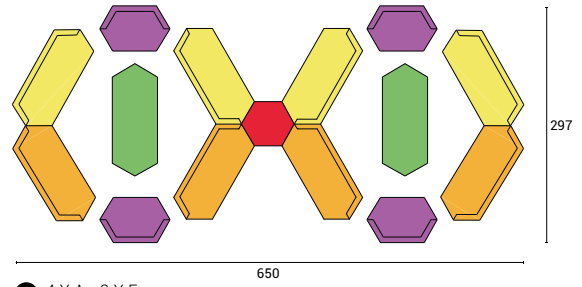

P 4 X A 2 X E
4 X B 1 X F
4 X D

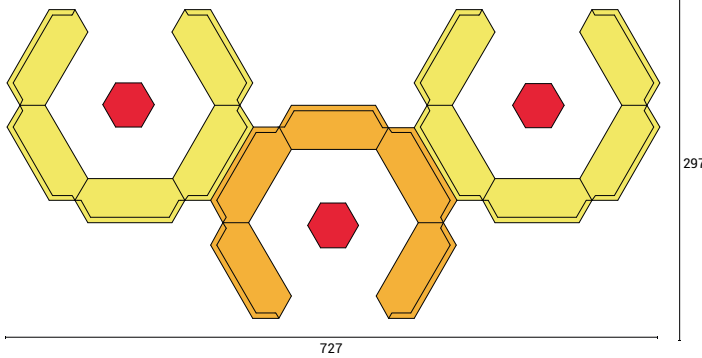

Q 10 X B
5 X D
3 X F

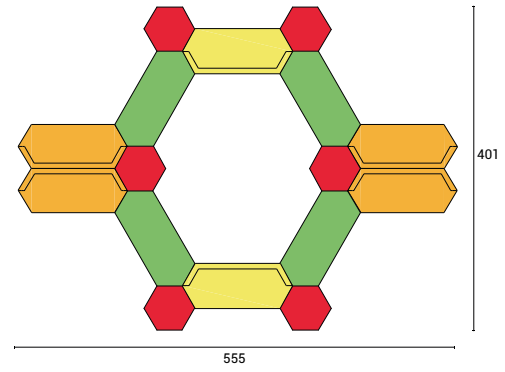

R 12 X B
6 X D
3 X F

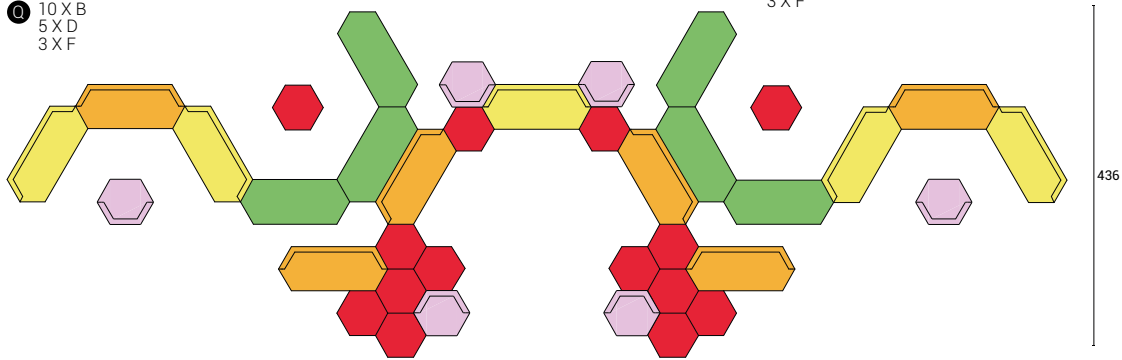

S 5 X B 6 X E
6 X C 14 X F
6 X D

11M

DESIGN ITALO PERTICHINI

TIGRAM

RIVESTIMENTI CONSIGLIATI:



PHOTO GALLERY:



Tigram low poltrona



Tigram low divano



Tigram high poltrona



Tigram high divano



Tigram chair



Tigram pouf small e maxi

<https://adrenalina.it/tigram/>

adrenalina
WE ARE DIFFERENT!