

DESIGN **ITALO PERTICHINI** **SLY**

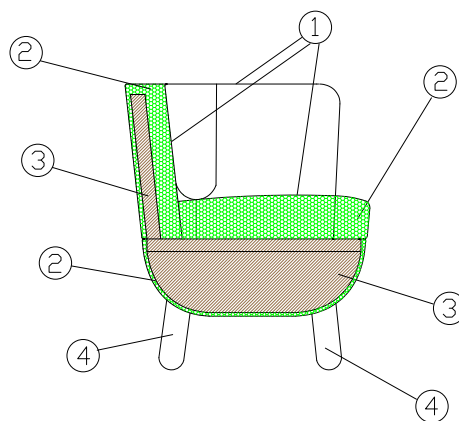

The full curves and wraparound form define the design of the Sly. Sly is available in two versions: with low back or high back, opening like a shell to welcome someone seeking a cozy corner or an oasis of privacy. Both versions are characterized by two small, "magical windows" - cracks that open to the outside world, but that retain discretion and privacy, closed with colored strings that break the severity of the lines with their lacing.

- 1 - dacron® fiber 100 gr;
- 2 - high resilience polyurethane foam of different densities;
- 3 - structural frame in plywood;
- 4 - natural beechwood feet.



**DIMENSIONS:**

**Low**

1S

2S

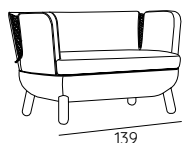
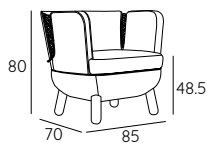

**High**

1S

2S

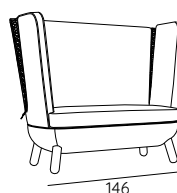
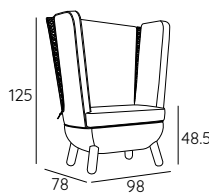

**FEET:**

h 15

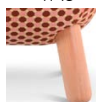

<https://adrenajina.it/sly/>

**adrenajina**  
WE ARE DIFFERENT!

# SLY

DESIGN ITALO PERTICHINI

## WOODEN FEET FINISHINGS:



## COLOR STRINGS:

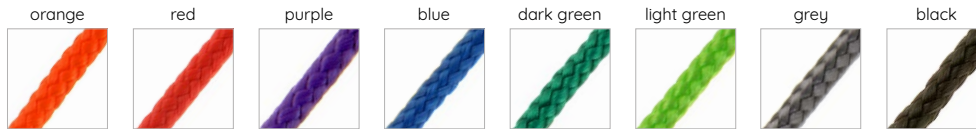

**MATERIALS:**  
polypropylene HT string  
UV-stabilised  
diam. 3 mm

## TECHNICAL DETAILS:

Removable cover: NO	kg	m <sup>3</sup>	mts
SLY 1S LOW	23	0.47	(1) 2.50 (2) 2.50
SLY 2S LOW	34	0.77	(1) 3.70 (2) 3.70
SLY 1S HIGH	37	0.95	(1) 2.80 (2) 3.70
SLY 2S HIGH	48	1.16	(1) 4.50 (2) 5.00

IS Sly low

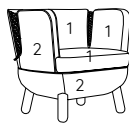

2S Sly low

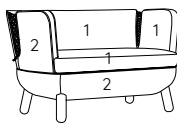

IS Sly high

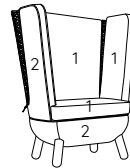

2S Sly high

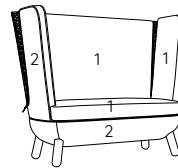

## SUGGESTED FABRICS:



# SLY

DESIGN ITALO PERTICHINI

.....  
**PHOTO GALLERY:**



Sly low armchair



Sly high armchair



Sly high sofa



DESIGN ITALO PERTICHINI **SLY**



Curve piene e forma avvolgente sono i tratti principali delle sedute Sly. Due le versioni disponibili: con schienale basso o schienale alto, come un guscio che si schiude ad accogliere chi cerca un angolo raccolto o un'oasi di privacy. Entrambe sono caratterizzate da due piccole "finestre magiche" chiuse con corde colorate intrecciate, fessure che si aprono sul mondo esterno, ma che conservano discrezione e riservatezza spezzando con la loro sinuosità il rigore degli schienali.

- 1 - fibra di dacron® 100 gr;
- 2 - poliuretano espanso indeformabile di diverse densità;
- 3 - telaio in multistrato di legno;
- 4 - piedi in legno di faggio naturale.

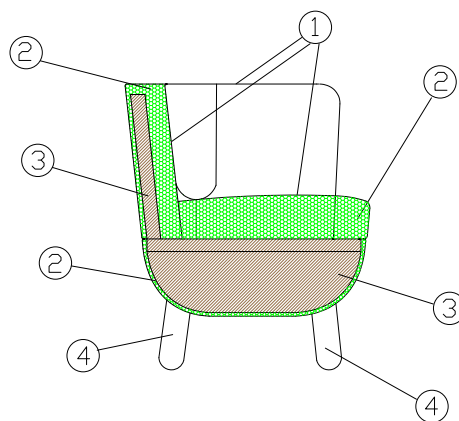

**DIMENSIONI:**

**Low**

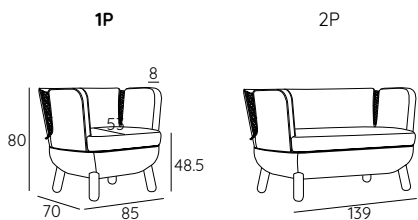

**High**

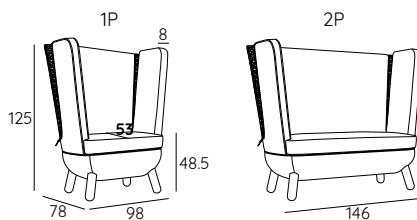

**PIEDI:**



<https://adrenalina.it/sly/>

**adrenalina**  
WE ARE DIFFERENT!

## FINITURE LEGNO PIEDI:



## COLORI CORDE:

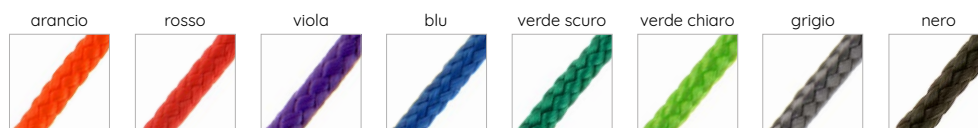

## MATERIALI:

corde di polipropilene HT stabilizzato ai raggi HV diam. 3 mm

## INFORMAZIONI TECNICHE:

Sfoderabile: NO	kg	m <sup>3</sup>	mts
SLY 1P LOW	23	0.47	(1) 2.50 (2) 2.50
SLY 2P LOW	34	0.77	(1) 3.70 (2) 3.70
SLY 1P HIGH	37	0.95	(1) 3.70 (2) 2.80
SLY 2P HIGH	48	1.16	(1) 5.00 (2) 4.50

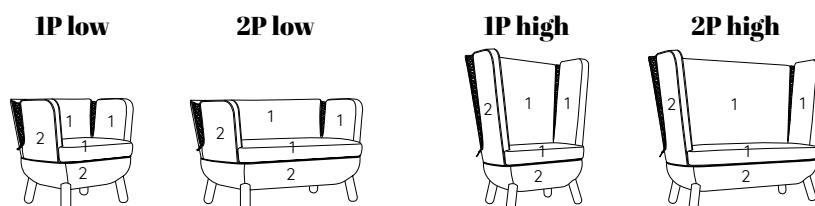

## RIVESTIMENTI CONSIGLIATI:



# SLY

DESIGN ITALO PERTICHINI

PHOTO GALLERY:



Sly low poltrona



Sly high poltrona



Sly high divano

