



BROCHURE

Copyright © 2021



INNOVA Quilting Systems

Words can barely describe our cutting-edge, innovative, state-of-the-art longarm quilting systems.

INNOVA's have been thoroughly tested through stress and strain analysis to reach new heights of engineering excellence. They are the most streamlined, balanced, lightweight, high-speed quilting machines available on the market.

From machines to robotics and accessories, our class-leading line of precision engineered quilting machine systems offer:

- Unmatched stitching accuracy and reliability
- Exclusive patented features
- Outstanding user experience
- Superior customer service

Our commitment to leadership through innovation and a dedication to excellence have resulted in many patented and exclusive options for the INNOVA customer.

ABM International offers a complete line of optional equipment so you can customize your INNOVA quilting machine to best suit your needs for the ultimate experience in longarm quilting.

Form & Function meet
Art & Science



M Series INNOVA Quilting Machines

Building on INNOVA's classic strengths, the M Series INNOVA quilting machines were engineered and designed in the 21st Century with the latest in technology, combining both beauty and refined engineering. The M series of machines is the absolute best money can buy, integrating the finest materials available in both art and science. These machines have been tested to the highest standards utilizing stress and strain analysis to ensure they are the very best.

This includes:

- Viewing windows for LED diagnostics
- Integrated strip LED lighting system with black light, dim, and bright
- Integrated needle laser light
- Fully adjustable handles with multiple joints allowing nearly 360 degrees of rotation for perfect positioning
- Power button at front of machine
- Integrated Lightning Stitch control system with horizontal orientation and new user interface
- Integrated AutoPilot® Robotics when activated
- Integrated PantoVision® when activated
- Sound-deadening automotive insulation
- Platinum Warranty

Never Compromise!



INNOVA M28

The ultimate in function and beauty, the INNOVA M28 is designed to be paired with the AutoPilot® Mach 3 computerized quilting system for optimum creativity and maximum production. With 28 inches under throat, a beautiful sleek design and interactive Lightning Stitch interface, the INNOVA M28 with AutoPilot® Mach 3 will please the most demanding professional quilter and delight the creative genius with a plethora of editing tools available for limitless creativity.

M28 Specs

- 28" Throat
- Red anodized aluminum side panels
- Extruded aluminum modular construction
- AutoPilot® Mach 3 Compatible
- PantoVision® Compatible
- Sews standard and art threads
- Lightning Stitch regulation
- 3.5" Industrial Touch Panel Computer w/Windows CE Operating System
- AC servo motor
- AC servo drive
- Sealed ball bearings
- 1/2" drive shaft
- 2 – 22 stitches per inch
- Cruise
- Presets for stitch regulation
- Bobbin counter
- Stitch counter
- Integrated LED strip lighting plus Spectra Lite
- Viewing windows for LED diagnostics
- Needle laser light
- Flex handles
- Power button at the front of the sew head
- Automotive sound-deadening insulation
- Integrated cooling system
- Starter Kit with Ruler Base
- Bobbin Winder
- Platinum Warranty



INNOVA M24

The INNOVA M24 quilting machine provides **maximum flexibility**. Superior hand-guided control paired with ample area for computerized quilting makes this machine a very popular choice. With 24 inches under throat, a beautiful sleek design, and interactive Lightning Stitch interface, the INNOVA M24 will thrill the most discerning artist with its perfect balance and extraordinary control.

M24 Specs

- 24" Throat
- Blue aluminum side panels
- Extruded aluminum modular construction
- AutoPilot® Mach 3 compatible
- PantoVision® compatible
- Sews standard and art threads
- Lightning Stitch regulation
- 3.5" Industrial Touch Panel Computer w/Windows CE Operating System
- AC servo motor
- AC servo drive
- Sealed ball bearings
- 1/2" drive shaft
- 2 – 22 stitches per inch
- Cruise
- Three presets for stitch regulation
- Bobbin counter
- Stitch counter
- Integrated LED strip lighting plus Spectra Lite
- Viewing windows for LED diagnostics
- Needle laser light
- Flex handles
- Power button at the front of the sew head
- Automotive sound-deadening insulation
- Integrated cooling system
- Starter Kit with Ruler Base
- Bobbin Winder
- Platinum Warranty

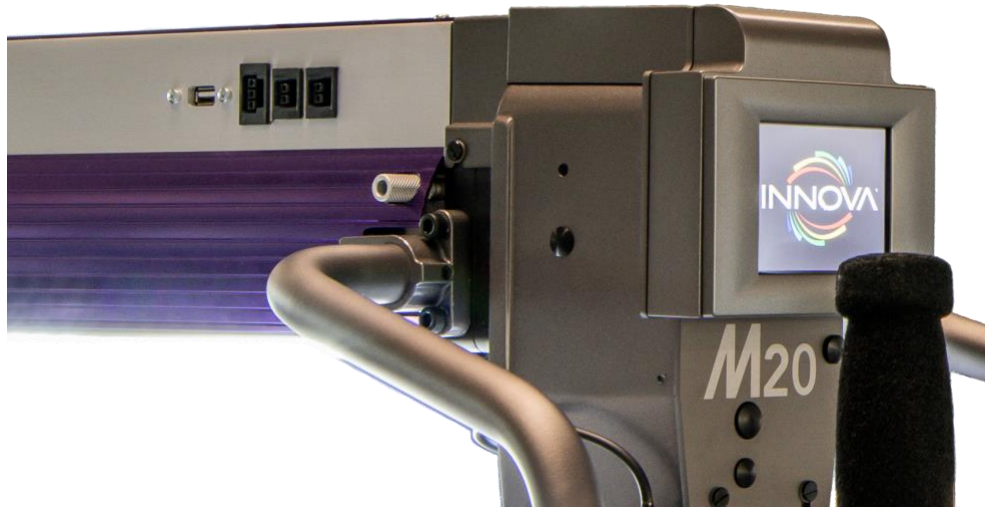

INNOVA M20

The INNOVA M20 offers *exquisite design* and function for the quilter who expects the best. With a beautiful sleek look and new Lightning Stitch interface, the M20 will produce the industry's finest quality stitch with a smooth and delightful hand. Suited to the hand guided quilter, this machine can be outfitted with the AutoPilot® Mach 3 computerized quilting system for optimum creativity.

M20 Specs

- 20" Throat
- Purple aluminum side panels
- Extruded aluminum modular construction
- AutoPilot® Mach 3 compatible
- PantoVision® compatible
- Sews standard and art threads
- Lightning Stitch regulation
- 3.5" Industrial Touch Panel Computer w/Windows CE Operating System
- AC servo motor
- AC servo drive
- Sealed ball bearings
- 1/2" drive shaft
- 2 – 22 stitches per inch
- Cruise
- Three presets for stitch regulation
- Bobbin counter
- Stitch counter
- Integrated LED strip lighting plus Spectra Lite
- Viewing windows for LED diagnostics
- Needle laser light
- Flex handles
- Power button at the front of the sewhead
- Automotive sound-deadening insulation
- Integrated cooling system
- Starter Kit with Ruler Base
- Bobbin Winder
- Platinum Warranty

INNOVA Quilting Machines

Industrial engineering and expertise is evident in the construction of the INNOVA Longarm Quilting Machine.

All INNOVA machines are constructed of a high-quality, extremely rigid aircraft grade aluminum profile and include the highest quality digital electronic components. The innovative 3-piece design invented and patented by ABM in 1996 is engineered to house top-rated sealed ball bearings and Teflon hard coated components to increase longevity and eliminate exposed grease and oils which can quickly ruin a quilt. Along with the largest (.5" diameter) driveshaft of any longarm machine, the INNOVA boasts many qualities including most importantly the fastest motor, lowest maintenance, most reliable stitch quality, and best customer service available in the longarm quilting community.

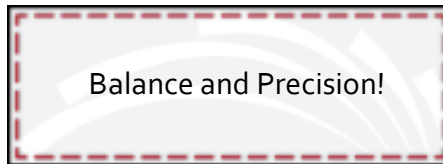

INNOVA's patented swivel sew head is exclusive to the INNOVA. This unique feature is included on all INNOVA quilting machines and makes adding innovative accessories, changing feet, removal of broken needles and preventative maintenance a breeze.

All INNOVA machines are equipped with a 3000 stitch per minute one horse motor for faster, more efficient quilting and better stitch regulation. The strong motor is capable of piercing multiple-layer seam allowances without stalling. Coupled with INNOVA's patented spring-loaded hopping foot, it seamlessly adjusts for varying quilt thicknesses and bulky seam allowances ensuring a quality stitch. The exclusive Lightning Stitch™ regulation is the highest rated stitch regulator available. Its AC digital brushless Sercos-based servo motor and control system along with its user-friendly interface ensures the user perfect stitches and maximum adjustability with award-winning results!

Standard features include both front and rear handlebars with start/stop controls, along with half stitch button and a selectable needle stop (up/down) position. The INNOVA quilting machine has a rotary thread tensioner, a laser and mechanical stylus, as well as a five-way adjustable fluorescent light. INNOVA comes standard with an M style large capacity hook for fewer bobbin changes and includes extra needles, bobbins, tool kit, dust cover, and stand-alone bobbin winder with auto shut off and speed control.

The only maintenance your INNOVA requires is general cleaning of thread lint buildup and regular lubricating of the bobbin area of your machine!

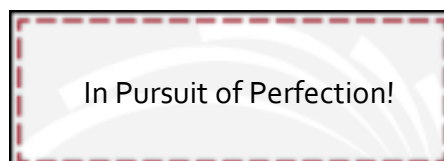



INNOVA Classic 26

The INNOVA Classic 26 quilting machine is the *professional's choice*. The large quilting space maximizes creative expression for the experienced free motion quilter and increases productivity when combined with the AutoPilot® Mach 3 Computerized System. Enjoy robust production at an exceptional value while experiencing the most accurate system on the market with an INNOVA Classic 26!

INNOVA truly is BUILT TO QUILT®!

Classic 26 Specs

- 26" Throat
- AutoPilot® Mach 3 compatible
- Navigator® P2 compatible
- PantoVision® T2 compatible
- Sews standard and art threads
- Lightning Stitch regulation
- 3.5" Industrial Touch Panel Computer w/Windows CE Operating System
- AC servo motor
- AC servo drive
- Sealed ball bearings
- 1/2" drive shaft
- 2 – 22 stitches per inch
- Articulated fluorescent light
- Min Sew Speed (Cruise)
- Starter Kit with Ruler Base
- Bobbin Winder

Classic Design
Proven Workhorse



INNOVA Classic 22

The INNOVA Classic 22 quilting machine is the *hand guider's dream*. Make the most of your space with the ability to efficiently quilt professionally or add the AutoPilot® Mach 3 computerized quilting system for automated output. Experience free flowing movement and unsurpassed value with an INNOVA Classic 22!

Classic 22 Specs

- 22" Throat
- Extruded Aluminum Pro Frame
- 10' or 12' Frame size
- Custom frame sizes available
- Leader Set
- AutoPilot® Mach 3 Compatible
- Navigator® P2 Compatible
- PantoVision® T2 Compatible
- Sews standard and art threads
- Lightning Stitch regulation
- 3.5" Industrial Touch Panel
Computer w/Windows
CE Operating System
- Sealed ball bearing shaft support
- 1/2" drive shaft
- 2 – 22 stitches per inch
- Articulated fluorescent light
- Min Sew Speed (Cruise)
- Starter Kit with Ruler Base
- Bobbin Winder

Cost-effective,
Balanced and Precise!



INNOVA Classic 18

The INNOVA Classic 18 quilting machine is the ***perfect choice*** for the home quilter who loves to hand guide and expects quality results. With a smaller footprint, this machine will fit nicely into your home quilting space. Experience the same quality professional high-end results of larger INNOVA systems within a smaller package and at a more affordable price. Your time matters - make it worthwhile with an INNOVA!

Classic 18 Specs

- 18" Throat
- Extruded Aluminum Pro Frame
- 10' or 12' Frame size
- Custom Frame sizes available
- Leader Set
- AutoPilot® Mach 3 Compatible
- Navigator® P2 Compatible
- PantoVision® T2 Compatible
- Sews standard and art threads
- Lightning Stitch regulation
- 3.5" Industrial Touch Panel Computer w/Windows CE Operating System
- Sealed ball bearing shaft support
- 1/2" drive shaft
- 2 – 22 stitches per inch
- Articulated fluorescent light
- Min Sew Speed (Cruise)
- Starter Kit with Ruler Base
- Bobbin Winder

The best value in
the industry!

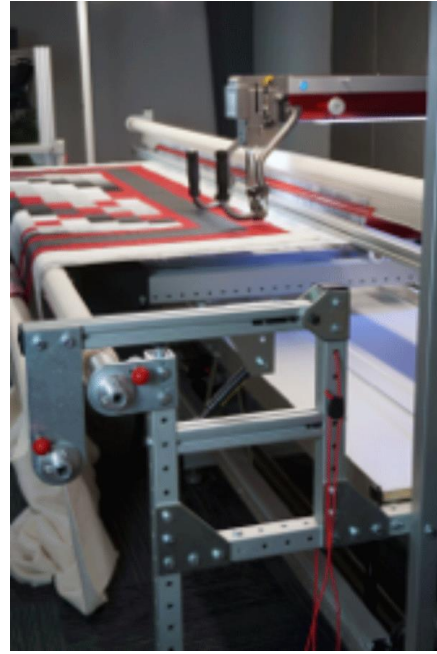

INNOVA Pro Frame

The commercial quality INNOVA Pro Frame is designed to maximize efficiency and ease of use. It comes with rigid 2" diameter steel fabric rollers, INNOVA's unique infinitely adjusting EZ Lock brake system, laminated tabletops, and two side clamps with tensioning bands. The gas-assisted top fabric pole lifting system provides easy access to straighten and inspect batting. This feature is critical to the discerning quilter. The Pro Frame has INNOVA's unique fabric take-up compensator that eliminates the need for raising and lowering as the quilt take up roll increases in diameter.

The frame is designed with plenty of free space below the front lifting bar which allows the quilter to sit comfortably at the INNOVA if desired. The INNOVA Pro Frame stationary compensator roller maintains a perfectly level quilting bed and ensures stitch quality. The EZ Lock roller system allows for infinite adjustment of fabric tension, which is critical for stitching reliability. Two nylon side tension clamps with adjustment straps are also included.

The INNOVA Pro Frame includes high quality canvas leaders and sturdy 3/4" laminated table tops which are perfect for placing pantographs, or they can double as a sewing or cutting table when your longarm is not in use. The INNOVA Pro Frame has six adjustable self-leveling legs with perforated extensions, so it can be adjusted up to 13" to accommodate your desired quilting height. Its unique modular construction allows for the addition of accessories at any time. Feel free to customize your frame with our many available options.

Pro Frame Specs

- 10- or 12-foot length
- Custom sizes available
- Perforated extruded aluminum tubing
- Adjustable height from 30"-42"
- Includes leaders
- Side clamps
- Machine leveling legs
- Gas-assisted lifting top fabric roller
- Adjustable two bar take-up roller system
- Adjustable stationary quilt backing roller
- 2" diameter steel rollers
- EZ Lock infinite adjustment roller system
- Manual Channel Locks
- Super Glide Carriage System for industry-leading effortless movement
- Heavy duty laminated wood tabletop



Computerized Systems

In 1985 ABM International was awarded its first United States Patent #4,505,212, confirming ABM as the original inventor of the computerized quilting machine! More recently ABM has been awarded for its groundbreaking ability to embroider on a longarm quilting machine.

With our extensive understanding and experience of industrial and home robotics quilting systems, you can rest assured ABM has the natural ability to deliver the same robust quality in their robotics and software as they do with the INNOVA quilting machines.

ABM's proprietary motion control hardware and software is made in the USA and allows the quilter to layout the quilting designs for individual blocks or the entire quilt. The Autopilot system includes a 3-axis AC servo system for high-speed quilting, controlled acceleration and deceleration with unmatched reliability and performance. Its repeatability and positioning are unrivaled in the industry. Editing features are available to realize a quality result, whether it be a simple resize, a quick edge-to-edge layout, detailed custom creation, or an original design drawn directly onscreen! Continually improving and adding new features, updates are included with our systems.

Always utilizing the latest technology paired with a penchant for industrial quality and innovation, ABM offers software and robotics from PantoVision® T2 (hand guided digital pantograph guidance system, patented) to Navigator® P2 (mid entry robotics), to full featured AutoPilot® Mach 3 with the ability to add Grand Format Embroidery® with Path Apply and Applique!

Increase your productivity and release your creativity with a computerized quilting system from ABM International for INNOVA!

Feature	PantoVision™2	Navigator™2	AutoPilot™Mach3
Included Patterns	51	110	661
Pattern Pad	◆	◆	◆
Pattern Pad Manager	◆	◆	◆
Gesture Screen Capable	◆	◆	◆
Undo	◆	◆	◆
Redo	◆	◆	◆
Pattern Positioning Options	◆	◆	◆
Pause Settings			◆
Auto Tie Off Settings			◆
Bobbin Counter Settings			◆
Snap to Grid	◆	◆	◆
Quilt Grid Labels	◆	◆	◆
Customizable Top Panel	◆	◆	◆
Multiple Projects	◆	◆	◆
Customizable Color Theme	◆	◆	◆
Pattern Settings	◆	◆	◆

Feature	PantoVision TM 2	Navigator TM 2	AutoPilot TM Mach ³
Sewhead TM Interaction			◆
Select	◆	◆	◆
Delete	◆	◆	◆
Copy/Paste	◆	◆	◆
Flip	◆	◆	◆
Mirror	◆	◆	◆
Rotate	◆	◆	◆
Resize	◆	◆	◆
Group	◆	◆	◆
Un TM Group	◆	◆	◆
Attach		◆	◆
Link		◆	◆
Reverse TM Sew	◆	◆	◆
Push TM Pins		◆	◆
Zoom TM In	◆	◆	◆
Zoom TM Out	◆	◆	◆
Active TM Zoom	◆	◆	◆
Pan	◆	◆	◆
Record		◆	◆
Grab	◆	◆	◆
Drop	◆	◆	◆
Nudge	◆	◆	◆
Add TM Repeats	◆	◆	◆
Less TM Repeats	◆	◆	◆
Trim		◆	◆
Measure			◆
Align		◆	◆
Wreath		◆	◆
Multiply	◆	◆	◆
Boundary TM			◆
Morph		◆	◆
Mask			◆
AutoFit			◆
Endsnap			◆
Split/Divide			◆
Create/Delete TM Segment			◆

Feature	PantoVision™2	Navigator™P2	AutoPilot™Mach3
Join			◆
EdgeToEdge			◆
Crosshatch			◆
Draw/Edit			◆
Text>Create			◆
Echo			◆
EmbroideryCapable(GFE)			◆
PathApplyCapable(GFE)			◆
PatternCrosshairs	◆	◆	◆
PatternLock			◆
ChannelLock			◆
Encryption	◆	◆	◆
FullView	◆	◆	◆
ActualSize	◆	◆	◆
RunningView	◆		
PopcornTrail	◆		
Reposition	◆	◆	◆
SewZone		◆	◆
Home	◆		
SewOptions		◆	◆
PatternSave	◆	◆	◆
ProjectSave	◆	◆	◆
ProjectRecovery	◆	◆	◆
PatternTags	◆	◆	◆
SizeableBackgroundImage	◆	◆	◆
AdjustableSewhead?			
Crosshairs	◆		◆
CustomizeableNotification?			
Sounds			◆
TensionCheckCamera?			
Compatible	◆	◆	◆
VariableSpeedControl		◆	◆
PolyurethaneSteel?			
ReinforcedTimingBelt?			
Drive		◆	◆
ZeroBacklashGear?			
ReductionUnits		◆	◆



AutoPilot® Mach 3

Increase your productivity and release your creativity with AutoPilot® Mach 3™. Our robotics systems accept ABM proprietary .pat, certain .dxf file types, and encrypted files. Utilize the easy Edge to Edge feature or implement the many tools available to create a truly original masterpiece. The AutoPilot® Mach 3 has a high number of convenience features designed for the serious custom quilter as well as the increased productivity needed to make this great pastime a profitable business.

Building on the INNOVA's ability to sew 3000 stitches per minute, the maximum travel speed is 15 inches per second with an average travel speed of 8 inches per second. The AutoPilot® Mach 3 operates under true servo control, the same as found on our large format industrial quilting machines. Our robotics system controls the speed of the sew head and carriage. Through a complex mathematical program, AutoPilot® actually looks ahead at the pattern path being sewn, calculates its position and maximizes its speed to maintain accurate stitches per inch and pattern quality. ABM International has been manufacturing computerized quilting machines since the 1980's and has proven the AutoPilot® system to be both reliable and efficient.

INNOVA truly is BUILT TO QUILT!®

Autopilot® Mach 3 Specs

- Dell All-In-One touch-screen computer
- 3-axis servo controller
- AC servo motors
- Hi-flex cables
- Over 600 patterns
- Compatible with all INNOVA Quilting Machines
- Resize, Rotate, Flip, Mirror
- Repeat
- Record
- Grand Format Embroidery compatible (GFE)
- User-friendly interface
- Mask
- Echo, Ripple, Spiral
- Boundary
- Align
- Auto Fit (point to point)
- Edge to Edge
- Morph
- Wreath
- Trim, Divide, Segment
- Draw
- Join
- Crosshatch
- End Snap
- Background Image
- Push Pins
- Reverse Sew
- Power Assist
- Channel Lock
- Tension Check compatible
- Preview
- Set Order
- Thread Break Recovery



Grand Format Embroidery® and Applique

INNOVA is the only longarm quilting system with embroidery capability.

Import and stitch any .dst embroidery pattern. With no "hoop" to limit the size, stitch patterns of **Grand** size!

Run repeats perfectly straight for beautiful lace! Create applique effortlessly.

Path Apply offers over 60 choices of stitch motifs to apply to any path (pattern line). With the built-in ability to create your own motifs, the possibilities are limitless!

INNOVA truly is BUILT TO QUILT!

GFE Specs

- Grand Format Embroidery
- Patented industry-exclusive feature
- 3-axis full control
- AutoPilot® Mach 3 compatible
- Hoopless embroidery
- Limitless embroidery sizes
- Unlimited embroidery stitches
- Accepts .dst file type
- Queue and Dequeue layers
- Assign colors
- Includes Path Apply
- Create and modify Motifs
- Automates Applique

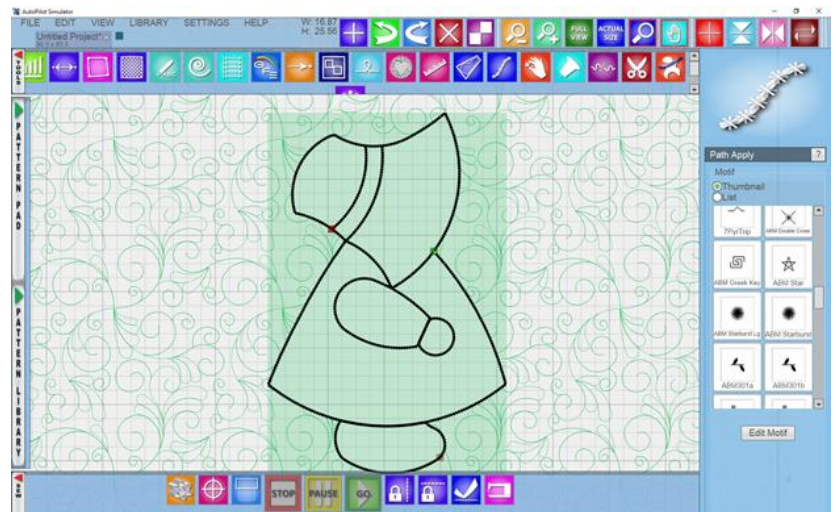



Navigator® P2

Equipped with the Microsoft Surface Tablet, the Navigator P2™ provides capabilities for design layout, editing, and complete control of final pattern stitch out. Navigator P2's ability to upload .dxf file format patterns or INNOVA's proprietary .pat file format provides compatibility with thousands of digitized quilting patterns and designs. With the Navigator P2®, patterns can be resized, trimmed, copied, and rotated. Free-motion quilting can be recorded and saved as a new pattern. The thread break recovery feature is an excellent safeguard in the event the bobbin thread runs out. The sewing head can be moved to the exact location and stitching can resume from that point.

Equipped with robust stepper motors and American-made electronics, the Navigator® P2 easily delivers quality professional results suitable for hire to the casual home user.

Navigator P2 Specs

- Microsoft Surface Pro tablet
- 2-axis motion controller
- DC stepper motors
- Over 100 patterns
- Compatible with Classic INNOVA Quilting Machines
- Resize, Rotate, Flip, Mirror
- Repeat
- Record
- User-friendly interface
- Align
- Multiply
- Morph
- Wreath
- Trim
- Push Pins
- Reverse Sew
- Power Assist
- Tension Check compatible
- Preview
- Set Order
- Thread Break Recovery

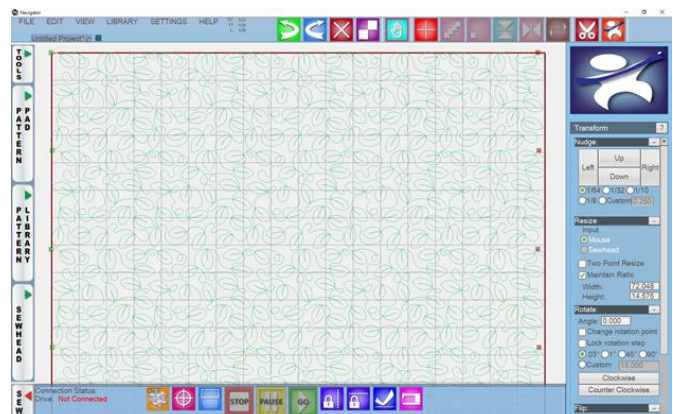



PantoVision® T2

PantoVision is another ABM innovative patented design and the industry's only digitized pantograph guidance system for longarm quilters. Enjoy quilting pantographs from the front of your machine. When advancing your quilt, PantoVision® digitized pantograph guidance system for longarm quilters makes lining up patterns a breeze as compared to traditional style paper pantographs. PantoVision® includes a library of patterns and allows the quilter to produce edge-to-edge quilts effortlessly by providing a fully digitized pantograph system. Patterns can be purchased over the internet or the user can design their own using a drawing program. Those designs can then be attached, nested and resized to create your very own pantograph patterns in limitless sizes and variations. Increase your productivity and release your creativity with a PantoVision® Guidance System!

PantoVision® T2 Specs

- Microsoft Surface Pro Tablet
- 92 digital patterns
- Compatible with any INNOVA system
- No more PAPER patterns!
- Trace
- Popcorn
- Target
- Resize
- Flip, Mirror, Rotate

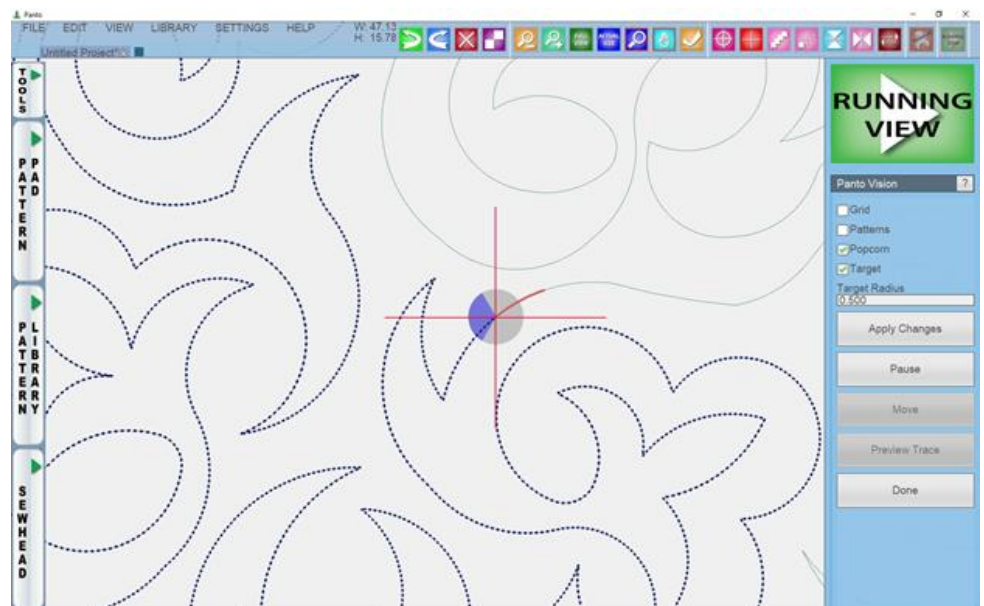



INNOVA Accessories

ABM International offers a complete line of optional equipment so you can customize your INNOVA quilting machine to best suit your needs. This makes the INNOVA truly unique as its modular design allows for limitless upgrades without the need for drilling, cutting, welding and painting as would be required on other systems in the market.

Crank Handles

Add the in-house precision engineered INNOVA Crank Handles to aid in rolling your fabric. Our crank handles are precision machined in-house in our CNC machine shop to our exacting specifications from billet aluminum and anodized to protect them for long life.

Crosshatch Ruler System

INNOVA's exclusive built-in Crosshatch Ruler can be added to the Pro-Frame for multiple angle crosshatching. This unique system replaces the by-pass roller with a special quarter round slotted guide rail. The Crosshatch Ruler attaches to the by-pass bar and provides stability for better control and accuracy. This frees up one hand for moving the machine while helping to support the ruler.

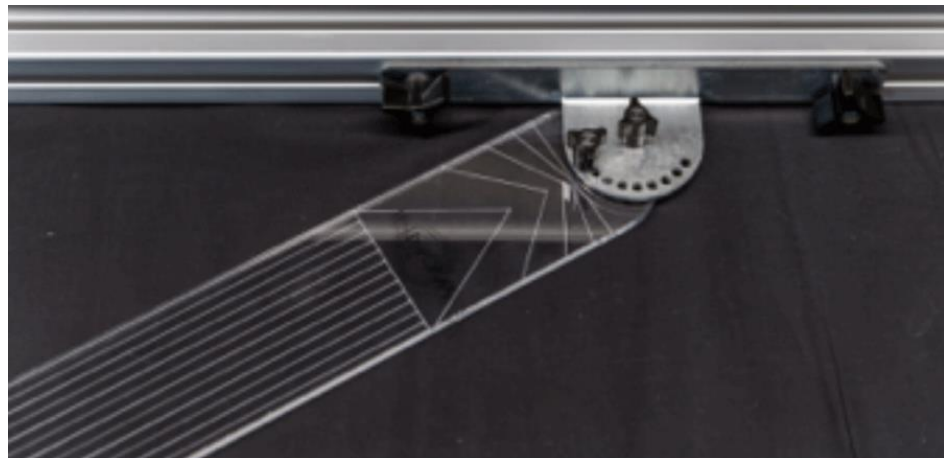

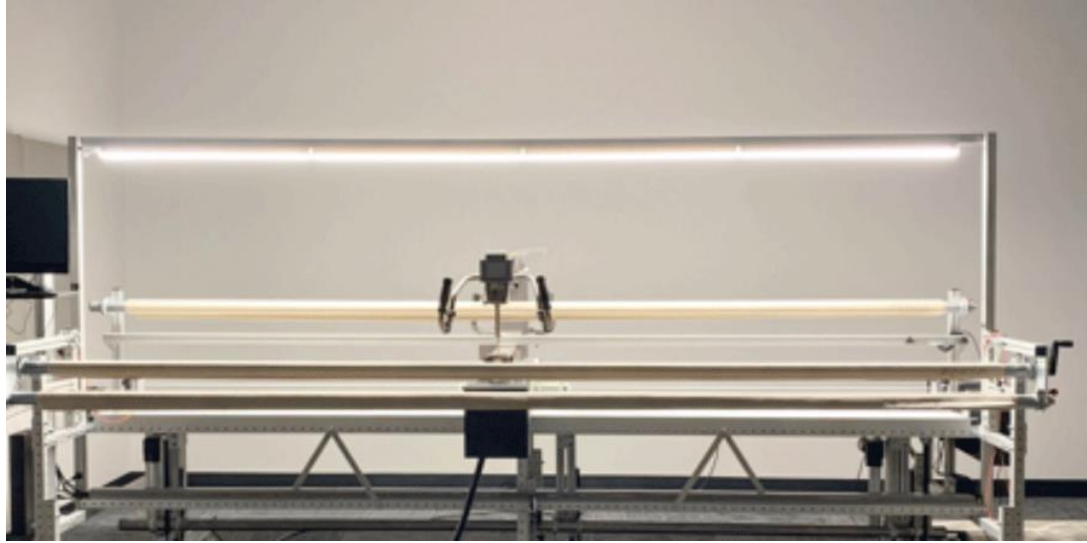

Light Bar

Light up your space with the INNOVA Light Bar to enhance your quilting experience. The Light Bar plugs into the INNOVA power distribution box or can be plugged into any 120-volt receptacle. Its low voltage LED design provides excellent light right where you need it. The 12' Light Bar emits 9,000 lumens with a color temperature of 4000K.

Side Spool Holder

The INNOVA has been proven to run many specialty threads including metallics, silks, cottons, and mono-poly. Feel confident running specialty threads that are purchased on spools using INNOVA's Side Spool Holder.

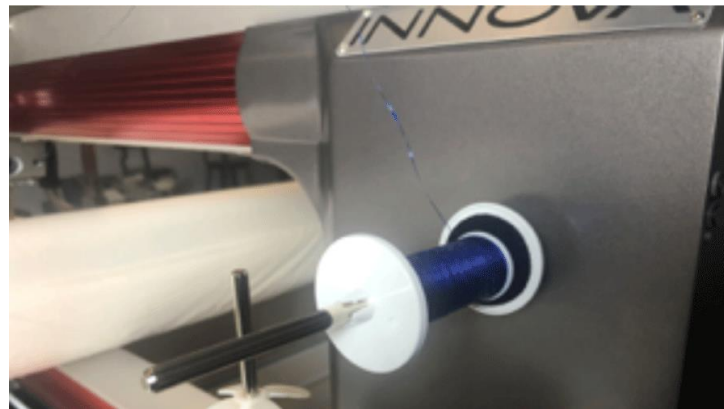

Power Advance

The INNOVA motorized advance is available for the quilter looking to save some time or enjoy some well-deserved convenience. Easily wind and unwind the take up roller by adding this industrial hypoid gear drive motor with driver. This will reduce strain on your hands and help people with ailments.

INNOVATECH Thread

Designed especially for the INNOVA quilting machine, INNOVATECH thread is durable, beautiful, smooth, and virtually lint free.

- Exclusively developed thread engineered specifically for multi-directional longarm quilting
- 40-weight poly wrapped poly (27 tex)
- A sleek design and beautiful finish allow for maximum efficiency while providing superior visual appeal
- Available in 61 of the most popular color choices
- 3000 or 6000 yard cones



L n M Bobbin Winder

Wind bobbins with perfect tension for superior quilt stitches with the L n M Bobbin Chief. This bobbin winder is designed to wind bobbins of both L size and M size so you can quickly wind bobbins for both your INNOVA and your regular sewing machine without having to remove thread from your machine. Our bobbin winder includes a tension set LED and automatic shutoff. It includes storage for up to 40 bobbins.

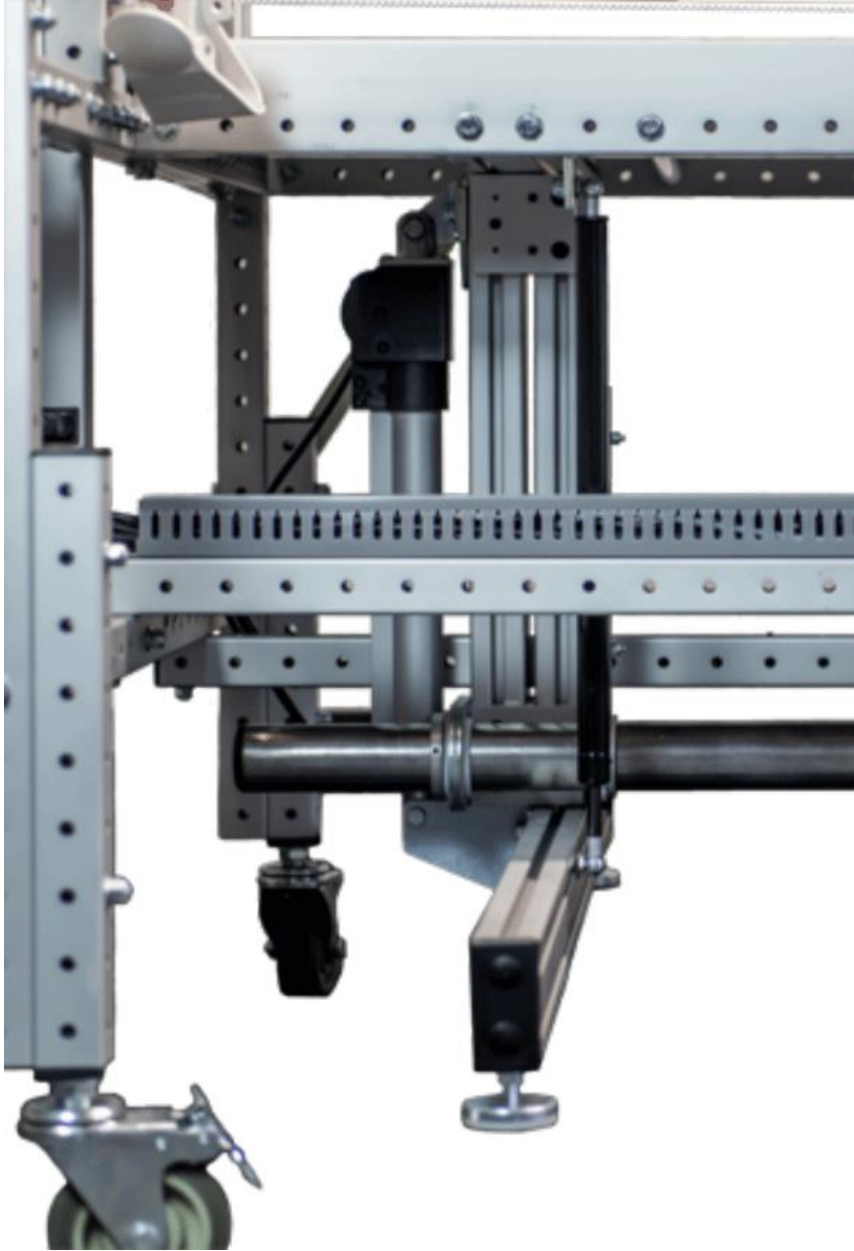

Electric Lift

INNOVA's ergonomically friendly electric powerlift system is free of messy hydraulic oil and is an excellent enhancement to the superior quality Pro-Frame. If you rent time on your machine, have multiple quilters, or just like to switch between sitting and standing, the INNOVA's powerlift system is a welcome upgrade. Equipped with compact motorized linear actuators and a rack and pinion leveler system, the INNOVA powerlift system is quite unique. With the push of a button quickly raise and lower the complete INNOVA system up to 11" in height.



Magnifying Glass

When performing micro stippling (or for those of us that just can't see well) the INNOVA magnifying glass is a welcome attachment.

Specialty Feet

Customize your system with the type of hopping foot best suited for your use. Whether you enjoy quilting with rulers, are looking for a specialty cup foot for computerized quilting, or embellishing with our couching foot set, we have the perfect foot for you.

- Cup Foot
- Billet Machined Open Toe
- Open Toe Feet
- Clear Standard Set
- Standard Foot
- Trapunto Foot
- Clear Echo Set
- Clear Couching Set
- Ruler Foot
- Billet Machined Heavy Duty Foot



More INNOVA Accessories



- Electric Channel Locks
- Adjustable micro handles for classic machines
- Sm Ruler Base
- Lg Ruler Base
- INNOVA exclusive patented timing tool with needle height gauge
- Locking Casters
- Red Vortex M Bobbin
- Spectre LED Light for classic machines

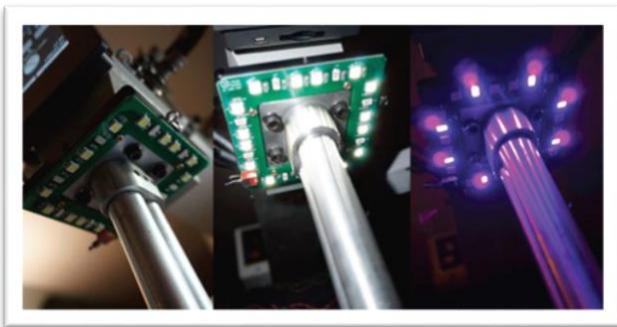
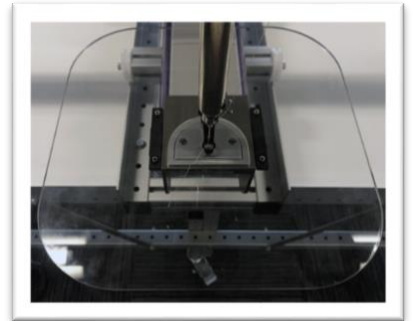
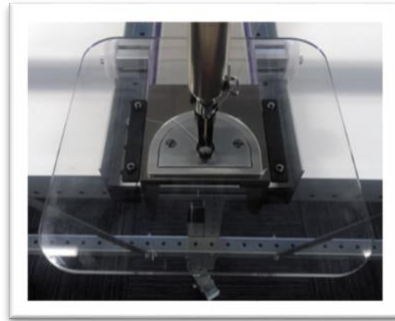
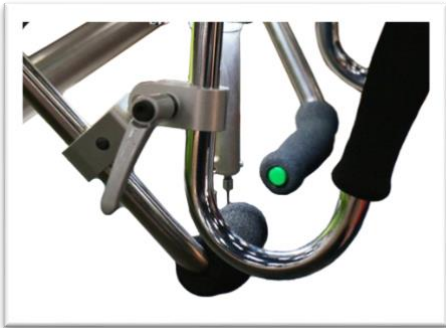



Training Centers

ABM's commitment to innovation and leadership is setting the standard for customer service and training perfection. The most innovative and highest quality products must be matched with the best-in-class training experience. ABM's unique approach to creating full-service quilt training centers has created the standard by which all other manufacturers are judged. Our complex dealer network is compiled of the industry's most knowledgeable and respected educators and sales staff. INNOVA has made a commitment to its customers by guaranteeing that every customer receives a customized, hands-on training experience. INNOVA customers are 100% satisfied and we guarantee you will be, too!

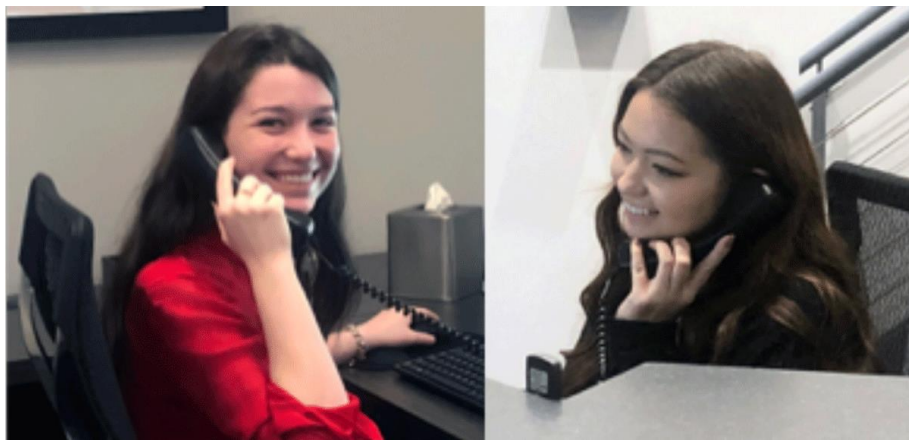

Customer Support and Service

The foundation of ABM International is built on family values and outstanding customer service. Our INNOVA customers have grown to rely on our free stateside based remote login support team. Provide us a code from your screen and we can access your machine and walk you through almost anything.

Because of ABM's commitment to excellence in manufacturing the need for service is rare, but rest assured that if you ever need technical assistance we are just a phone call away, 24 hours a day, seven days a week! 1-888-99-QUILT (78458).



White Glove Delivery and Installation

Experience the ultimate in delivery and set up by our ABM International White Glove certified team. Our dealers and our factory have the industry's best trained technicians. We know how it feels to let a stranger into your home for delivery, and we employ and train the very best people for the job. We can ensure your satisfaction and guarantee your delivery will be seamless and inspiring. Feel confident knowing that we will be there 24 hours a day, seven days a week to support you. The ABM family has been taking care of our customers for over 80 years, and it is our core philosophy to stand behind our products.



Testimonial Excerpts

"He truly exemplifies an "old school" work ethic, and it is greatly appreciated."

Julie Lucht

"I could not in any way be happier with my purchase!"

Cheryl Szykowski

"It was a delight....AMAZING to work with a truly fabulous dealer!"

Amy Lobsiger

"I learned, we laughed.....I'm the happiest person...."

Liz Torrence

"I cannot say enough words to describe how happy I am with this product."

Karen Charles

"He was patient....explained...in a way I could understand and never seemed in a hurry or flustered if I asked him to repeat something."

Mary Cavitt

"...how happy I am with my Innova."

Nancy Bailey

"...I love my new machine."

Pat

"I know why I purchased an Innova and all of the owners are not wrong ABM is the best...."

Michelle

"Amazing knowledgeable help."

Carole

"My experience in working with her to resolve the issue was remarkably positive..."

Stefan C.

"The knowledge, competence, response, customer service was beyond what I expected..."

D.V.Ripley

"INNOVA stands behind their products and makes sure the customer is satisfied for years...."

Jane O'Clair

"I can't say THANK YOU enough.....technical guidance and patience...."

Michelle Palermo

"...commitment to excellence in your products and service."

Sharon Haertling

"I will NEVER buy anything but an ABM INNOVA....their customer service is #1."

Kathy V

"Thanks again, ABM International for a great machine and great customer support."

Carolyn

Platinum Warranty & Lifetime Pledge

ABM stands behind its INNOVA machines with the absolute best warranty in the industry and our Lifetime Pledge. Every INNOVA is built to last a lifetime and we pledge to provide you with a lifetime of service and support for the lifetime of your INNOVA machine. Our INNOVA machines have proven to be the very best, so why not back it with the very best warranty in the industry? That's why we've developed the very best comprehensive warranty in the business to protect you against manufacturing defects.

Rest assured if your INNOVA fails for whatever reason we will be there to back it up with outstanding support. For complete details and to see exclusions please visit our website at www.innovalongarm.com



Choice Brand of
Missouri Star Quilt Co.



Additional Information

Find endless information at www.innovalongarm.com
and www.abminternational.com

Call a dealer near you!
Locate a dealer near you at www.innovalongarm.com

Disclaimer: Information contained in this brochure is subject to change without notice to consumer. ABM reserves the right to make engineering changes and modify or change its products at any time without notice. This includes changes and or modifications to the machine, electronics, software, hardware, mechanical components, and frame specifications. Please confirm exact specifications with ABM or a Dealer nearest you at time of order placement.



ABM International Inc. Worldwide Headquarters, Montgomery Texas

ABM International Inc., headquartered near Houston, Texas, is a four-generation family owned and operated U.S. based manufacturing company and has been manufacturing quilting machinery for over 80 years. We are the oldest quilting machine manufacturer in the world.

At ABM, we are committed to manufacturing excellence and superior customer service. Let us provide you with the highest quality state-of-the-art quilting machines that will enhance your quilts, improve your productivity, increase your excitement, and ENSURE YOUR SUCCESS!



ABM International, Inc.

P.O. Box 1820

Montgomery, Texas 77356

Telephone: (936) 441-4401

Toll Free: (888) 99-QUILT

Fax: (936) 597-4410

Contact: info@innovalongarm.com

www.abminternational.com

www.innovalongarm.com

Copyright © 2021