

PLEASE SPEND 5 MINUTES READING THESE INSTRUCTIONS BEFORE USING YOUR NEW RIVET TOOL.

TRUST US, IT WILL SAVE YOU TIME AND INCONVENIENCE IN THE LONG RUN.



READ THIS MANUAL CAREFULLY BEFORE USING THE TOOL !

It is **IMPORTANT** to follow the safety instructions for adequate protection against injuries.

- This tool should be used **ONLY** to set blind rivets within the **TOOL'S CAPACITY**. It **MUST NOT** be used for other purposes, such as hammer, etc.
- This tool should be always operated with compressed air supply within the air pressure range 0.5Mpa ~ 0.7Mpa.
- Always **DISCONNECT** the air supply from the tool before changing the tool parts, such as jaws, etc.
- **DO NOT** use the tool in the environment described as below:
 - fuel and combustion air.
 - temperature rapidly rising.
 - humidity, rain, water, storm and thunder, lightning.
- When the tool is suspended by the operation hook during use, be sure the tool will not fall.
- When using the tool, always carry protective goggles, protective gloves, safety helmet, and other necessary protections. It is highly recommended for safety reasons.
- Only use genuine spare parts for maintenance and repairs.
- All repair work must be carried out by skilled personnel, when in doubt, always return the tool to the distributor.

DRPN250 Operation Manual

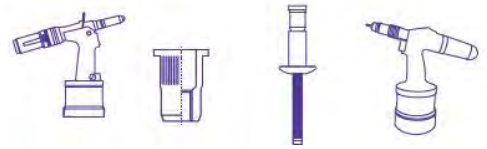

TOOL CAPACITY

Blind rivets 3.0mm / 3.2mm ~ 4.0mm ~ 4.8mm / 5.0mm standard.

TOOL SPECIFICATIONS

Air supply pressure:	0.5Mpa ~ 0.7Mpa
Output traction power:	10,300 N ~ 14,420 N
Stroke:	19mm
Net weight:	1.37kgs

GETTING STARTED

Please refer to the **TOOL EXPLOSIVE ILLUSTRATION** and the **PARTS LIST** in this manual in order to have a good understanding of the tool parts described. The descriptions of the tool parts appear in this manual are in *italics* with the parts position *numbers* corresponding to the tool explosive illustration.

- 1) This pneumatic powered tool should be used with a compressed air supply. It is recommended to use an air hose with a diameter bigger than 8mm.
- 2) Before connecting the tool to the compressed air supply, check that the compressed air pressure is within the specified range of between 0.5Mpa ~ 0.7Mpa. Once the air pressure has been confirmed, connect the air hose adaptor onto the tool *air adaptor* (#49). The air adaptor comes in different versions in different countries. Normally the tools are equipped with the correct version for your country as default, however, if the air adaptor you have received does is incorrect, please contact the tool distributor(s).
- 3) Change and use correct *nosepiece* (#1) according to the size of the rivet to be set. This tool is equipped with nosepieces 3.0mm / 3.2mm, 4.0mm, 4.8mm / 5.0mm (on the tool) in the kit. Follow the steps below to change the nosepiece (#1);
 - a) Remove the air supply hose from *air adaptor* (#49).
 - b) Use the *wrench* (in accessories pack) to remove the *nosepiece* (#1) from the tool as below;

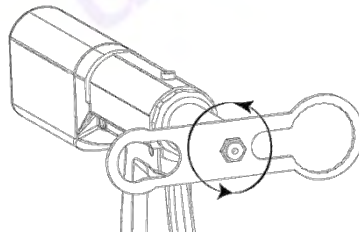

- c) Select the correct *nosepiece* in the accessories pack and screw on to the tool, using the *wrench* to fix it firmly on the tool.

Dafra Fastening Systems - Rivets Rivnuts & Tooling

1 / 7 Jarrah Dr, Braeside, VIC 3195, Australia

P: +61 3 9555 6872 | F: +61 3 9555 0803

E: sales@dafra.com.au | dafra.com.au



DRPN250 Operation Manual

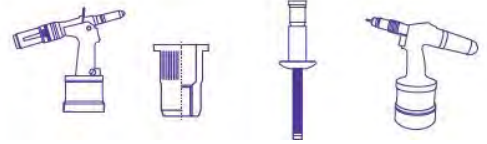

- 4) Install the *mandrel release protector* (in accessories pack) on the back of the tool.

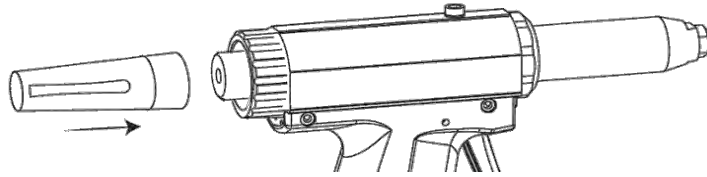

TOOL OPERATION FOR SETTING BLIND RIVETS

- 1) After completing the start-up preparations, place the rivet mandrel into the nosepiece, and holding the tool to insert the rivet into the pre-drilled hole of the work piece that needs to be fastened.
- 2) Pull the tool *trigger* (#45) to set the blind rivet in its position on work piece.
- 3) After setting the rivet, tilt the tool to the front in order to release the mandrel from inside the tool or tilt back the tool and the mandrel will be released from the back of the tool into the *mandrel release protector*. While using the tool, be sure always with the *mandrel release protector* on the tool, in case a mandrel comes shooting out from the back and causes injuries.

TOOL MAINTAINANCE

In order to maintain optimum performance after several weeks of regular use, add a few drops of hydraulic oil on the inlet of the *air adaptor* (#49) of the tool in order to reduce the friction of the tool parts since the oil will be blown inside the tool when tool is in operation.

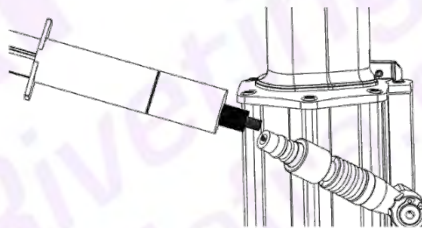

After a period of use, the tool stroke may be reduced which indicated that the hydraulic oil in the pneumatic tool needs to be refilled or changed;

- 1) Remove the *screw* (#11) with a hexagon wrench:

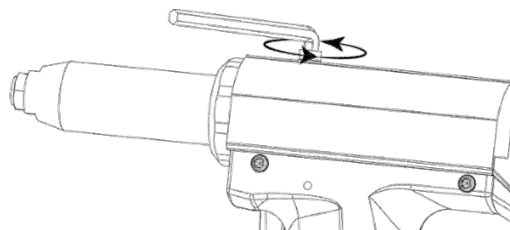

DRPN250 Operation Manual

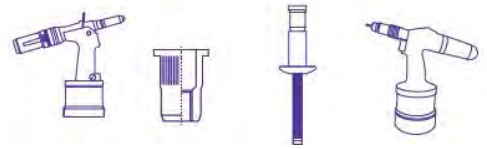

- 2) Connect the air supply and to place a cloth over the hole where the screw (#11) was removed, then to pull the *trigger* (#45) and the oil will be forced out from the tool;

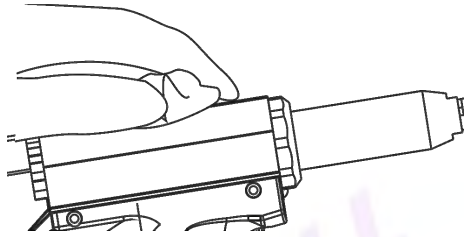

- 3) Screw the *oil inject adaptor* (in oil injector set in the accessories pack) into the hole where screw (#11) was removed;

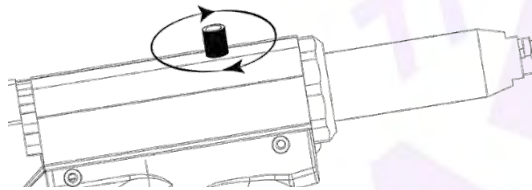

- 4) Use the *oil injector* (in the accessories pack) to slowly inject the oil until full (approx. 15ml). Remove the injector and its adaptor, then clean off any excess oil on the tool and tightly screw the screw (#11) back into the tool;

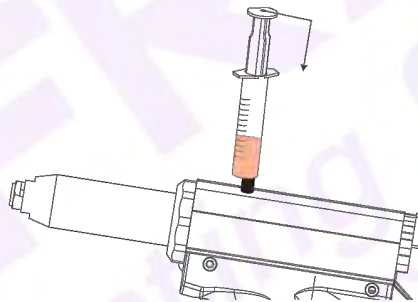

- 5) Test the tool stroke. If the stroke is still not what it should be, some air could have entered the *oil cylinder* (#13) while refilling the oil in the tool. To release this extra air from the tool, connect the tool to the air supply, pull the tool *trigger* (#45) 6 or 7 times, then loosen the screw (#11), to let the extra air leak out and then tighten the screw (#11) again.

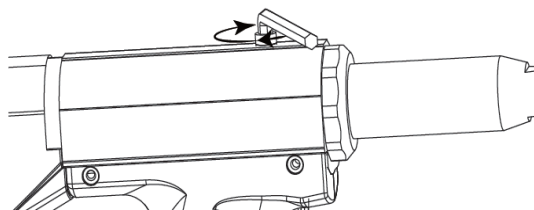

Dafra Fastening Systems - Rivets Rivnuts & Tooling

1 / 7 Jarrah Dr, Braeside, VIC 3195, Australia

P: +61 3 9555 6872 | F: +61 3 9555 0803

E: sales@dafra.com.au | dafra.com.au

DRPN250 Operation Manual

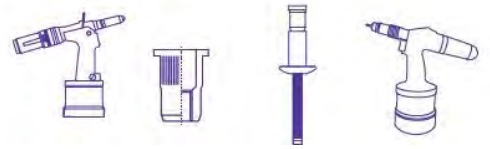

After extensive use, the tool may accumulate small metal chips from rivets within the nose assembly of the tool. This will compromise the tool's efficiency; therefore, it is recommended that you clean or change the nose assembly parts periodically.

- 1) Use the *wrench* (in accessories pack) and a spanner provided by user;

Included in accessories kit

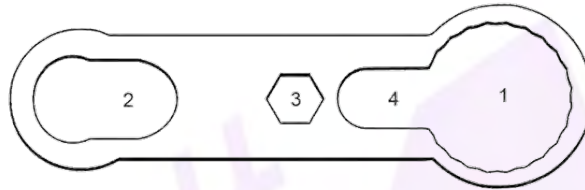

Provided by user

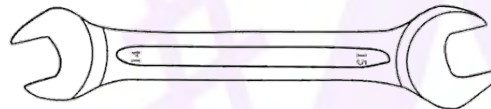

Wrench hole 1 for *compressed spring pedestal* (#21);
Wrench hole 2 for *clamping sleeve* (#3);
Wrench hole 3 for *nosepieces* (#1);
Wrench hole 4 for *front sleeve* (#2);

- 2) Remove the *nosepiece* (#1) on the tool using the *wrench* included in the kit;

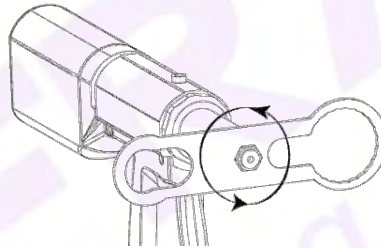

- 3) Disassemble the *front sleeve* (#2):

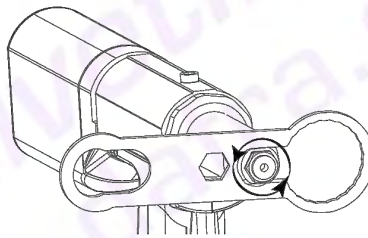

- 4) Disassemble *clamping sleeve* (#3):

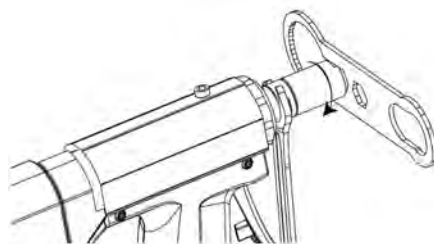

DRPN250 Operation Manual

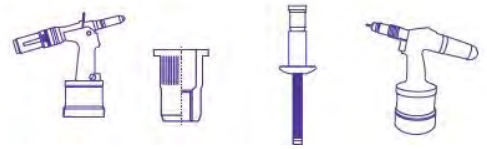

- 5) Take out the *3-jaw set* (#4) from the *clamping sleeve* (#3), then remove the *assembly pusher* (#5) and the *pusher spring* (#6) from the tool. Once removed, inspect all parts for wear before cleaning and replacing them. Any damaged parts should be replaced at this time.

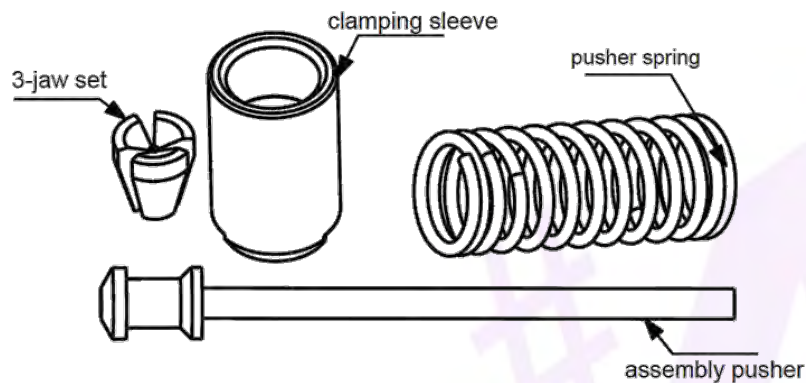

- 6) Re-assemble the cleaned or replacement parts. Put the *pusher spring* (#6) onto the *assembly pusher* (#5) and insert it back to the tool where *assembly oil cylinder* (#13) is located;

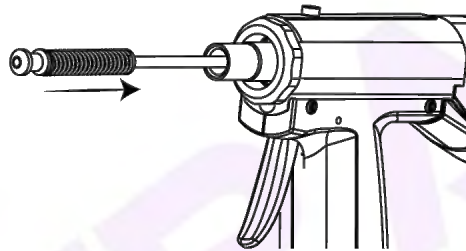

- 7) Place the *3-jaw set* (#4) into the *clamping sleeve* (#3) and be sure that all 3 jaws are seated in the correct position;



- 8) Place the *clamping sleeve* (#3) with the *3-jaw set* (#4) inside it onto the *assembly pusher* (#5) and ensure it is assembled firmly;

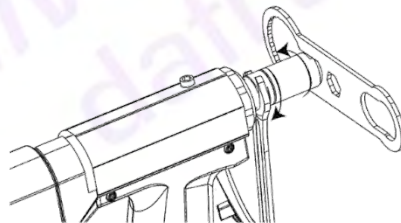

- 9) Replace the front sleeve (#2) and nosepiece (#1) on the tool;

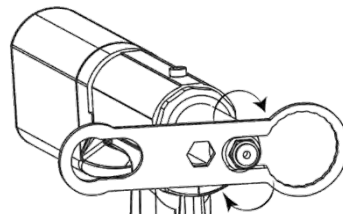

DRPN250 Operation Manual

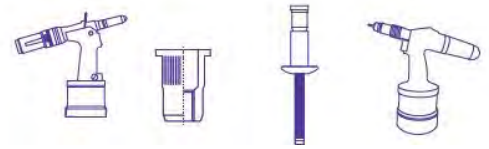

TROUBLE SHOOTING

Problem	Possible Causes	Solutions
Rivet mandrel does not break	<ul style="list-style-type: none">▪ 3-jaw set worn off or damaged.▪ Hydraulic oil in tool not sufficient.▪ Air supply with low pressure.	<ul style="list-style-type: none">▪ Change 3-jaw set.▪ Refill hydraulic oil.▪ Increase air supply pressure within the specified range.
Jaws slippery on rivet mandrel	<ul style="list-style-type: none">▪ 3-jaw set worn out.▪ Metal chips between jaws.▪ Pusher spring fatigued.	<ul style="list-style-type: none">▪ Change 3-jaw set.▪ Clean the jaws.▪ Change pusher spring.
Rivet mandrel cannot be put into nosepiece	<ul style="list-style-type: none">▪ Incorrect nosepiece size chosen.▪ Jaws get stuck by mandrel not being released.	<ul style="list-style-type: none">▪ Use correct size nosepiece for rivet.▪ Remove any jammed mandrels by disassembling front sleeve and clamping sleeve.

Dafra Fastening Systems - Rivets Rivnuts & Tooling

1 / 7 Jarrah Dr, Braeside, VIC 3195, Australia

P: +61 3 9555 6872 | F: +61 3 9555 0803

E: sales@dafra.com.au | dafra.com.au



DRPN250 Operation Manual

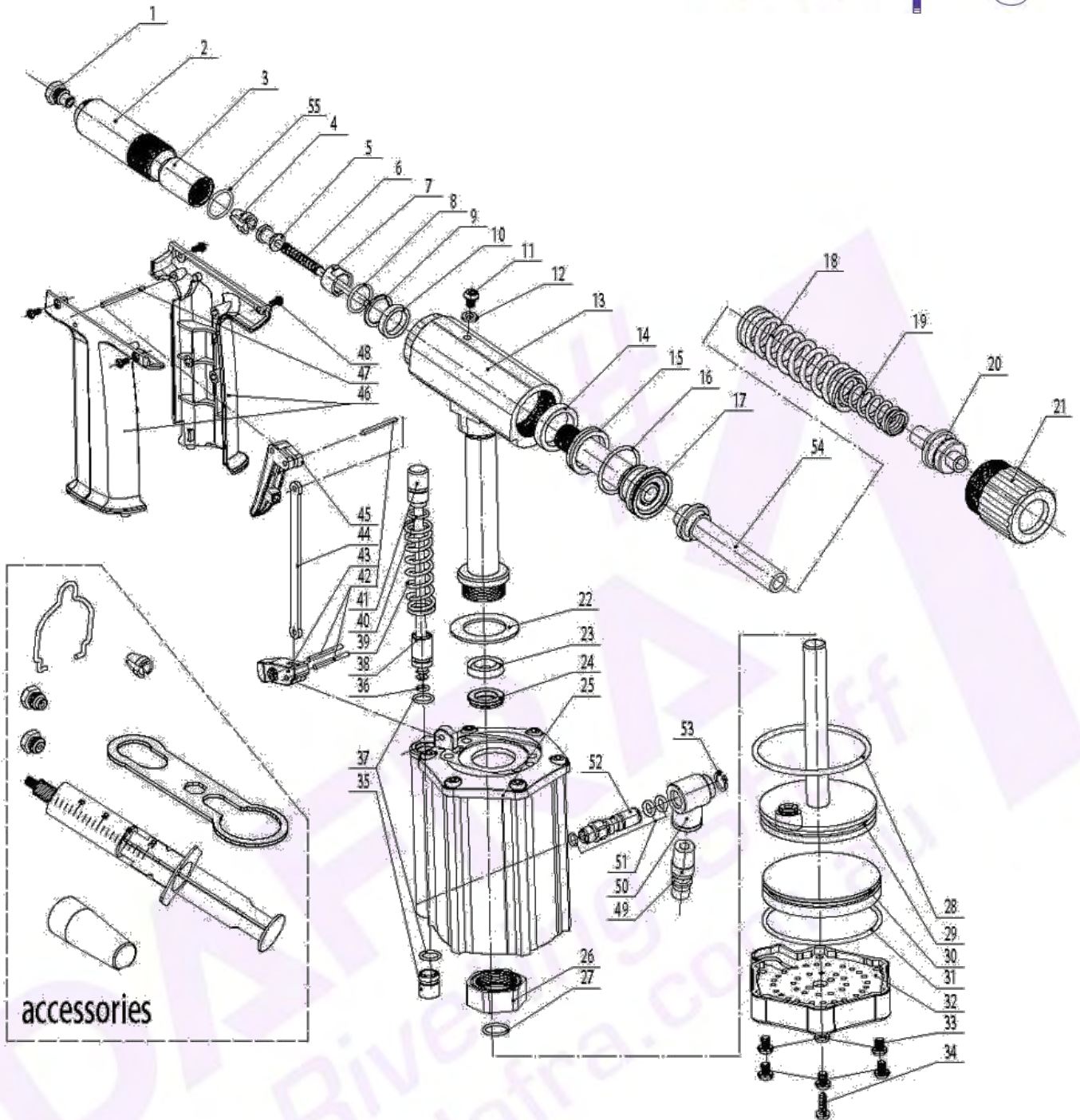
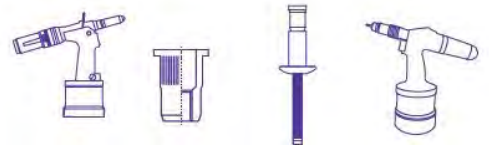

PARTS LIST

PART POSITION	PART CODE	DESCRIPTION	QUANTITY IN TOOL/KIT
1	P09005-00	Nosepiece 4.8mm / 5.0mm ID-E 3.3	1
2	A00001-00	Assembly front sleeve	1
3	P00252-00	Clamping sleeve 20-deg.	1
4	P00405-00	3-jaw set 20-deg.	1
5	A00002-00	Pusher 5.0mm	1
6	P00007-00	Pusher spring	1
7	P00173-00	Clamping sleeve locknut	1
8	F00021-00	O-ring	1

Dafra Fastening Systems - Rivets Rivnuts & Tooling

1 / 7 Jarrah Dr, Braeside, VIC 3195, Australia

P: +61 3 9555 6872 | F: +61 3 9555 0803

E: sales@dafra.com.au | dafra.com.au



DRPN250 Operation Manual

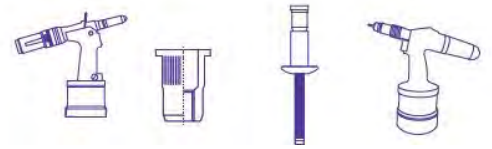

PARTS LIST - continued

PART POSITION	PART CODE	DESCRIPTION	QUANTITY IN TOOL/KIT
9	P00047-00	Support ring	1
10	F00022-00	U-ring	1
11	P00009-00	Screw	1
12	F00002-00	Washer	1
13	A02084-00	Assembly oil cylinder	1
14	F00003-00	U-ring	1
15	P00010-00	Piston pedestal washer	1
16	F00004-00	O-ring	1
17	A00063-00	Assembly plunger	1
18	P00118-00	Outer return spring	1
19	P00014-00	Inner return spring	1
20	P00212-00	Spring seat	1
21	P00016-00	Compressed spring seat	1
22	P00017-00	Oil cylinder washer	1
23	F00006-00	U-ring	1
24	P00018-00	Support ring	1
25	A00011-00	Assembly air cylinder	1
26	P00022-00	Oil cylinder locknut	1
27	F00007-00	O-ring	1
28	F00023-00	O-ring	1
29	A00012-00	Assembly air plunger	1
30	P00054-00	Piston pedestal	1
31	F00024-00	O-ring	1
32	P00055-00-00	Air cylinder bottom	1
33	P00021-00	Air cylinder screw	6
34	P00029-00	Air cylinder pedestal screw	1
35	P00030-00	Switch lower base	1
36	F00010-00	O-ring	1
37	F00011-00	O-ring	2
38	P00031-00	Switch upper base	1
39	P00032-00	Trigger shaft spring	1
40	F00012-00	O-ring	1
41	A00013-00	Assembly trigger shaft	1
42	F00013-00	Pin	3
43	P00057-00	Lever	1
44	P00245-00	Connecting rod	1
45	P00058-00-77	Trigger-short	1
46	A00069-00-00	Assembly grips	1
47	F00014-00	Pin	1
48	P00039-00	Screw	4
49	F00015-00	Air adaptor default	1
50	P00040-00	Adaptor joint	1
51	F00016-00	O-ring	3

Dafra Fastening Systems - Rivets Rivnuts & Tooling

1 / 7 Jarrah Dr, Braeside, VIC 3195, Australia

P: +61 3 9555 6872 | F: +61 3 9555 0803

E: sales@dafra.com.au | dafra.com.au



DRPN250 Operation Manual

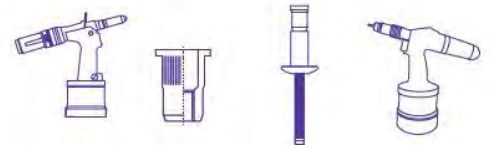

PARTS LIST - continued

PART POSITION	PART CODE	DESCRIPTION	QUANTITY IN TOOL/KIT
52	P00164-00	assembly air adaptor joint	1
53	F00048-00	A-circlip	1
54	A00062-00	assembly mandrel release	1
55	F00163-00	wave ring	1
Accessories Pack	P00405-00	3-jaw set 20-deg.	1
Accessories Pack	P09051-00	hook	1
Accessories Pack	P09050-00	mandrel release protector	1
Accessories Pack	P09002-00	nosepiece 3.0mm / 3.2mm ID-B 2.3	1
Accessories Pack	P09003-00	nosepiece 4.0mm ID-C 2.7	1
Accessories Pack	A00009-00	oil injection set	1
Accessories Pack	P03847-00	wrench	1

Dafra Fastening Systems - Rivets Rivnuts & Tooling

1 / 7 Jarrah Dr, Braeside, VIC 3195, Australia

P: +61 3 9555 6872 | F: +61 3 9555 0803

E: sales@dafra.com.au | dafra.com.au

