

H714 - Heckler AV Cart (Base Configuration)

Supports displays with a VESA 400 horizontal mounting pattern, and up to 300 pounds of total display weight.

Recommended for use with 50-inch to 75-inch displays.

Designed & made in Arizona
Patented

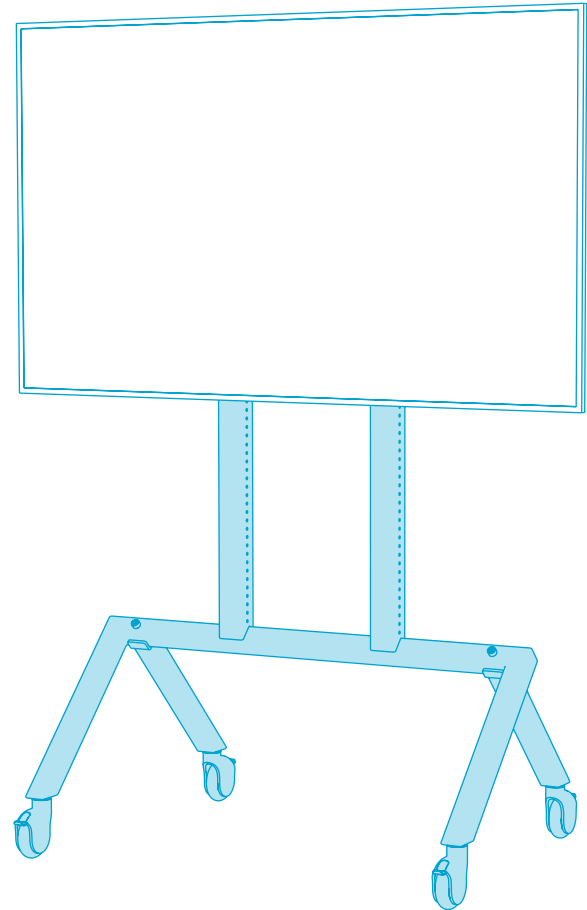

To reduce the risk of severe injury or death to persons, or damage to equipment, review these installation safety steps before proceeding:

1. A minimum of two people should install the display to the cart.
2. Caster brakes should be applied during the installation of the display.
3. Do not over-tighten the wingnuts when mounting the display.
4. Do not exceed 300 pounds of total display weight.
5. Whenever rolling the cart with a large display installed, two people should guide the cart to prevent wall and doorframe collisions, and tripping on sidewalk expansion joints.

If you have any questions, please contact Heckler.

service@hecklerdesign.com

844-432-5930

In the box

- A** 1 x Front Base
- B** 2 x Rear Leg
- C** 2 x Display Rail
- D** 4 x Caster
- E** 4 x Socket Head Screw, 1/2"-13, 2.75" Long
- F** 1 x Assembly Key, Hex, 3/8"
- G** 4 x Set Screw, M8, 70mm Long
- H** 4 x Wingnut, M8
- I** 4 x Set Screw, M6, 70mm Long
- J** 4 x Wingnut, M6
- K** 4 x Rubber Spacer
- L** 8 x Screw-in Cable Mount
- M** 4 x Push-in Cable Mount
- N** 8 x Pan Head Screw, 10-32, 0.25" Long
- O** 8 x Cable Tie

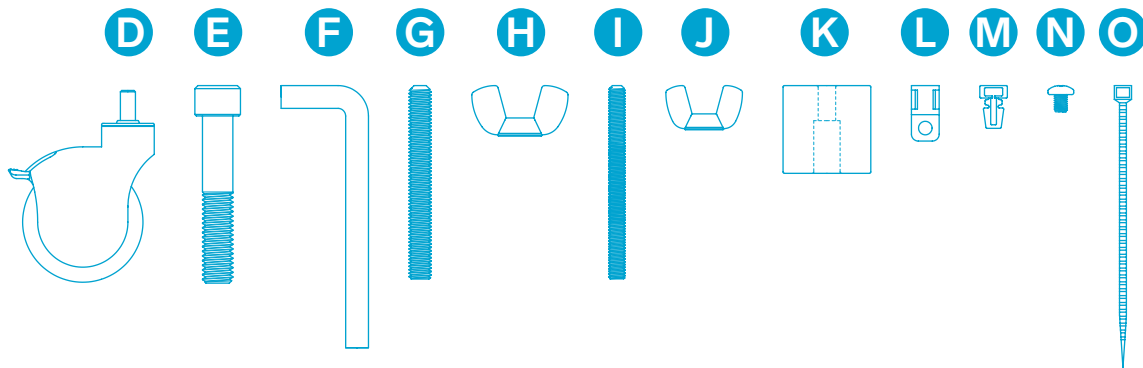
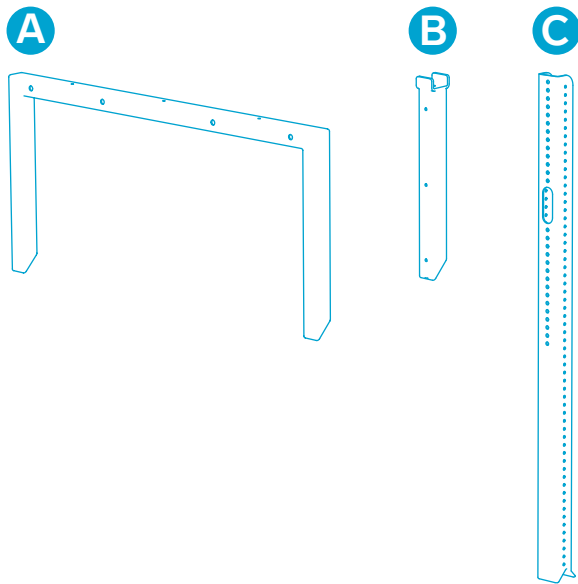

STEP 1

Remove the wheels from all four casters.

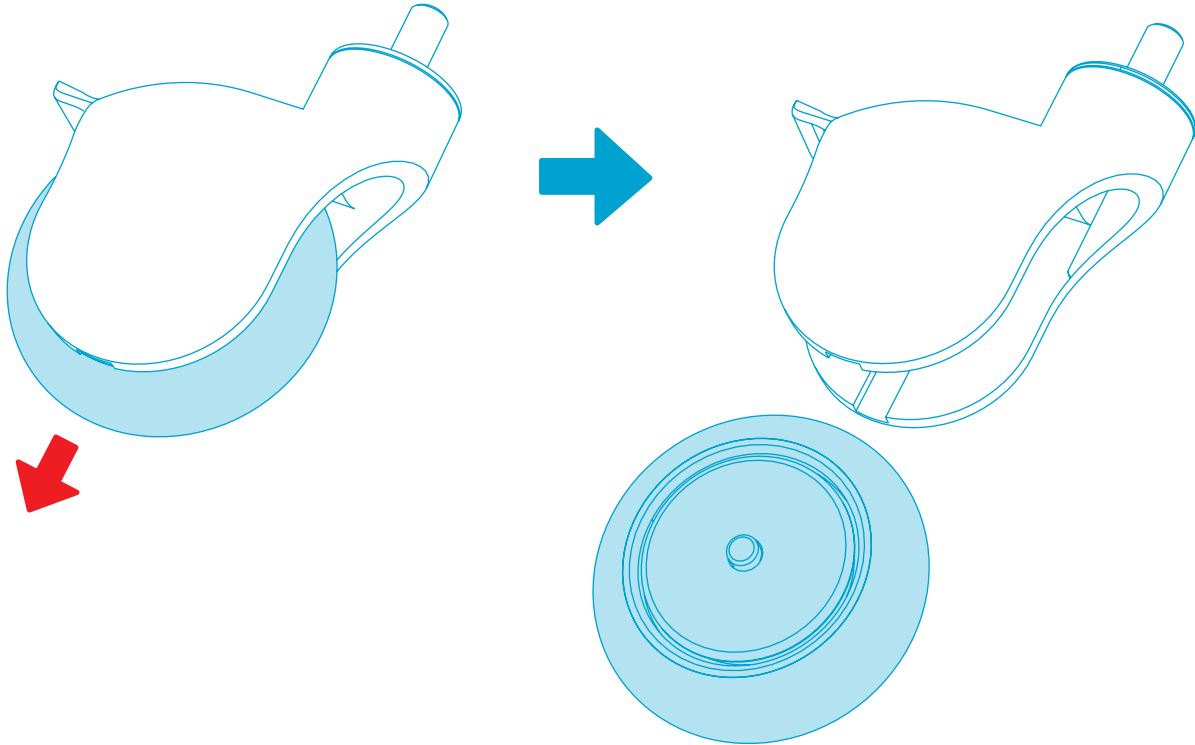

STEP 2

Install all casters.

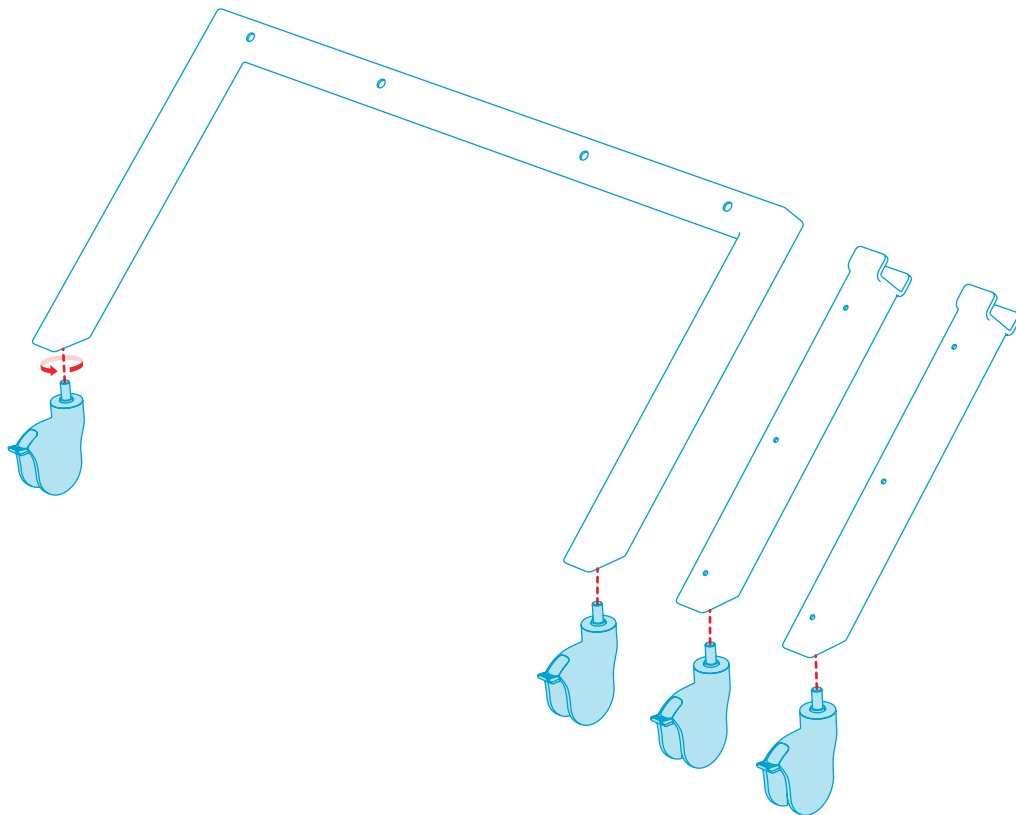
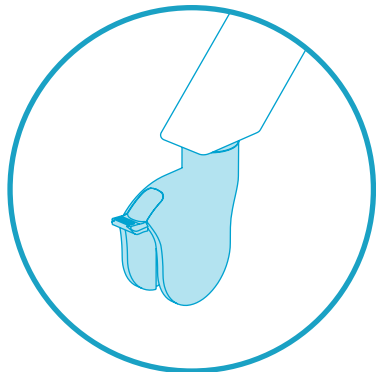
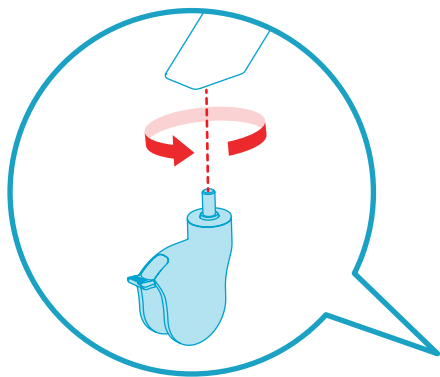

STEP 3

Reinstall caster wheels.

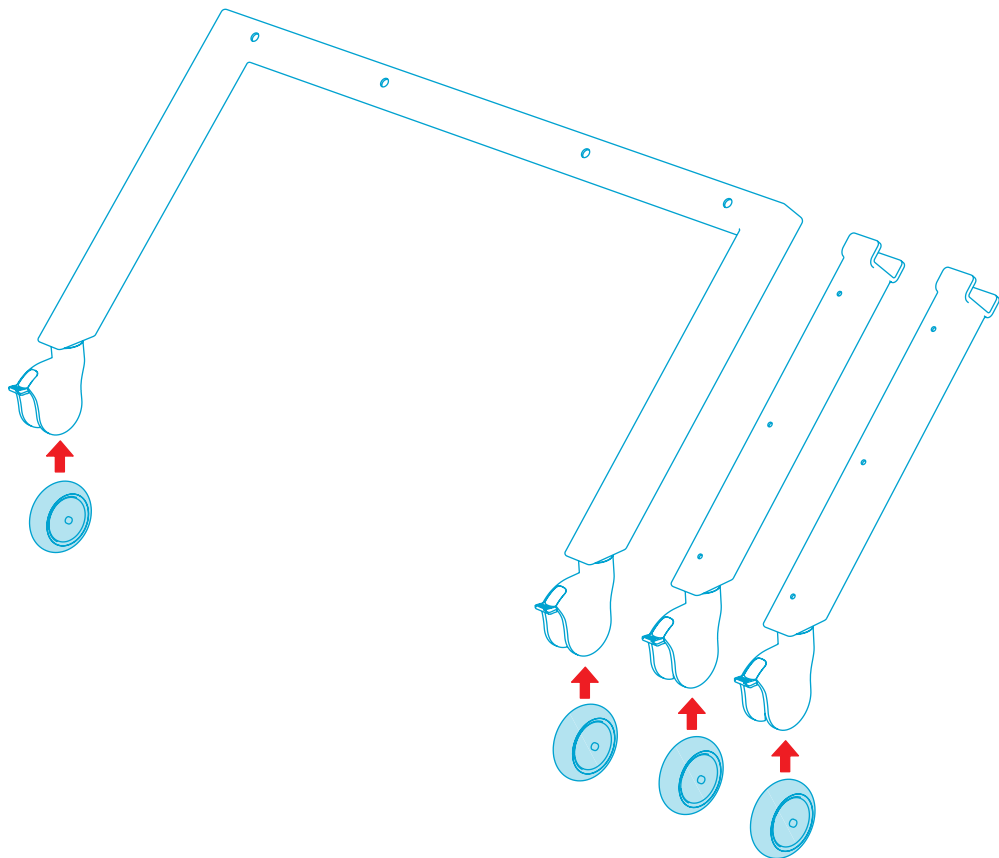
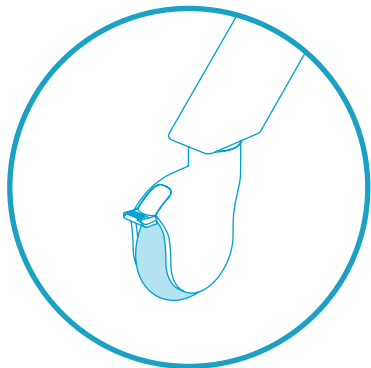
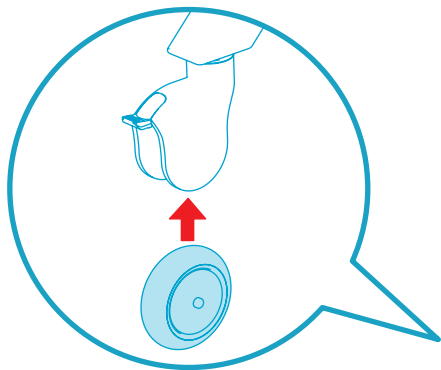

STEP 4

Engage all caster brakes.

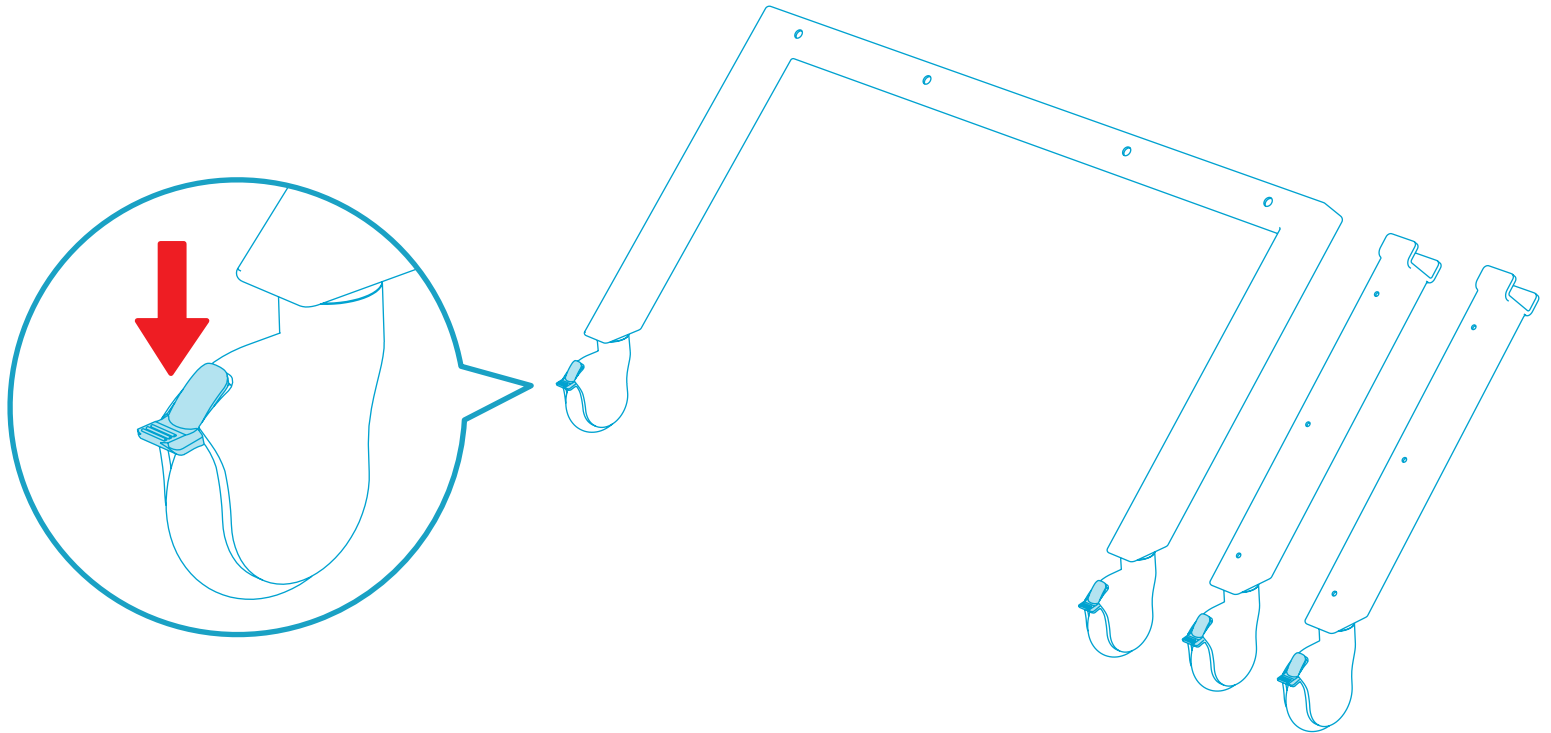

STEP 5

Fasten Rear Legs to Front Base.

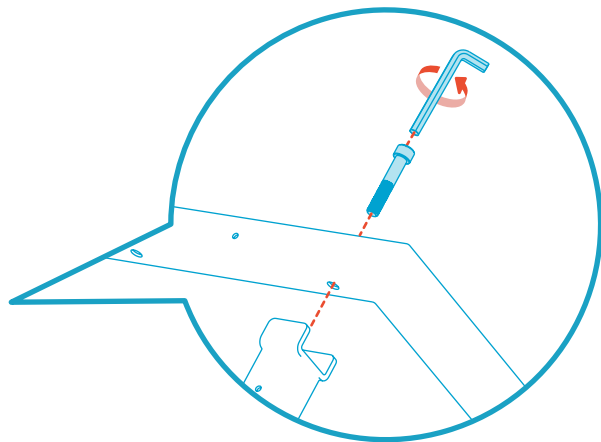
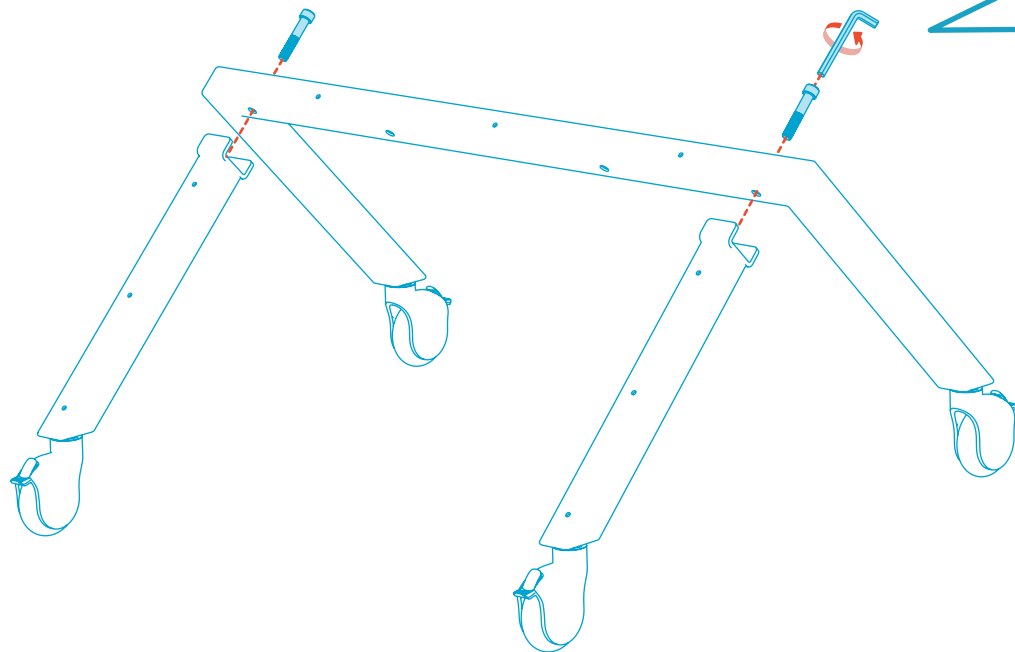
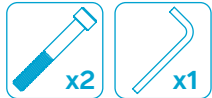

STEP 6

Fasten Display Rails to Front Base.

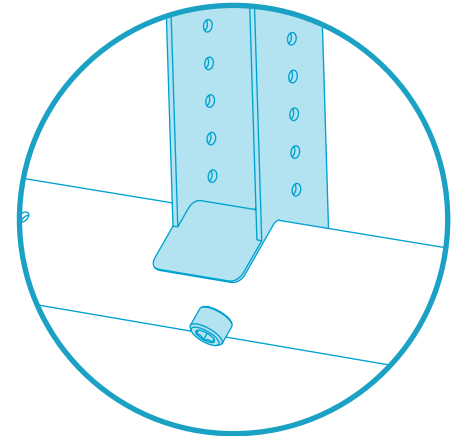
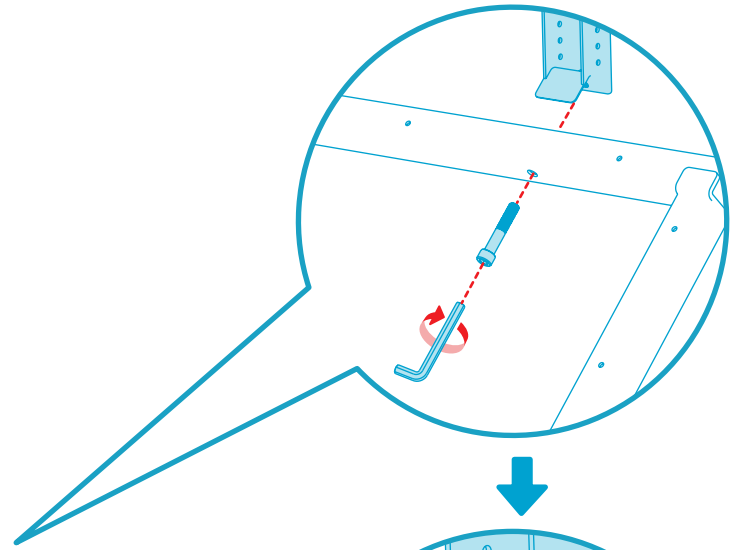
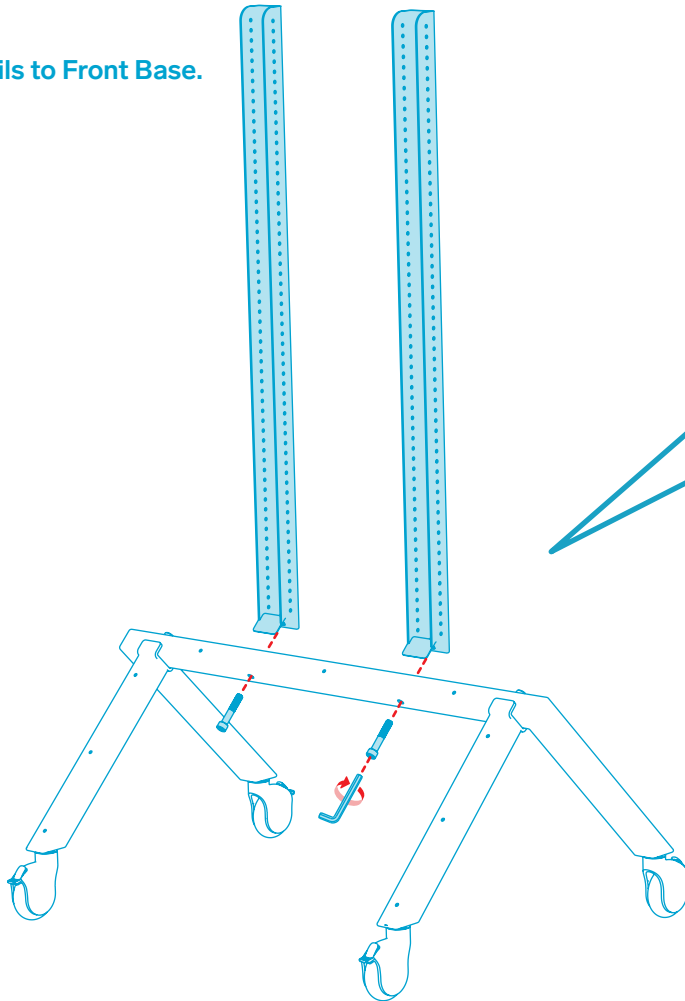

STEP 7

Determine whether your display has M8 or M6 mounting holes.

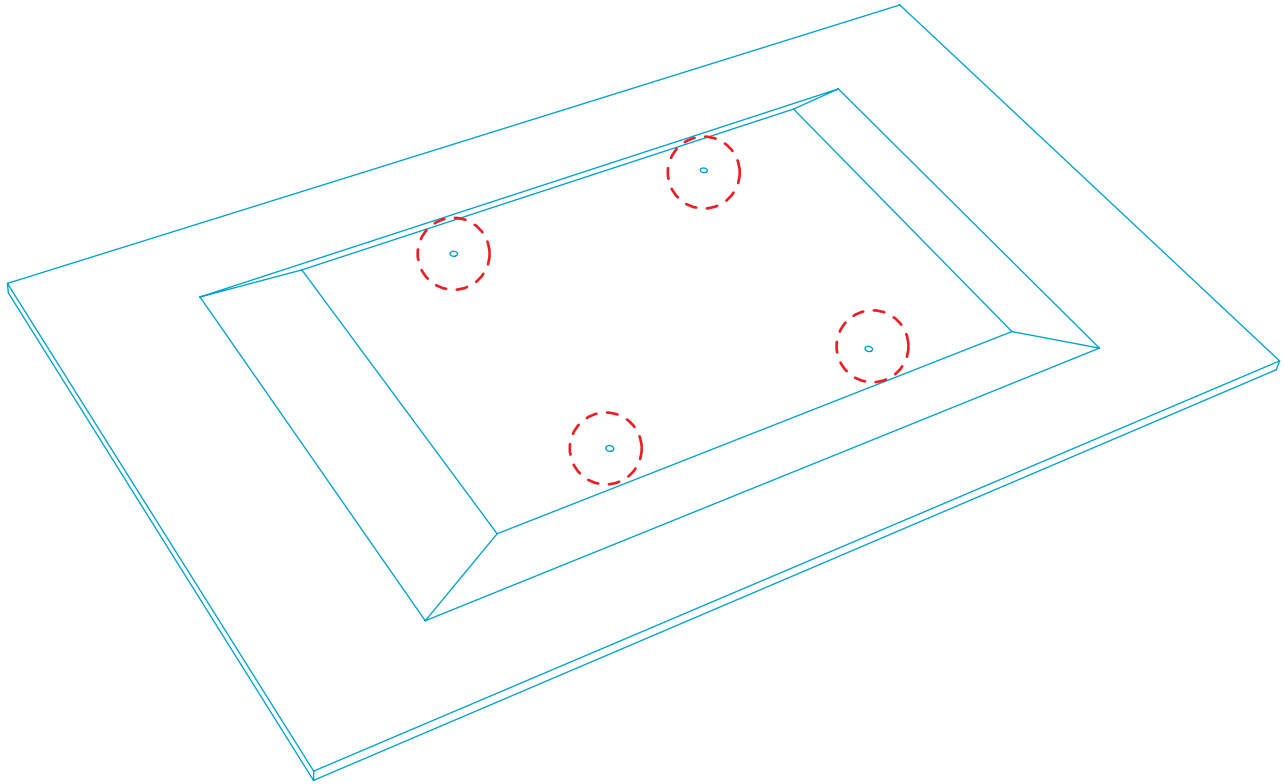

STEP 8

Prepare the display-mounting hardware.
Insert the M6 or M8 set screws through the rubber spacers.
Position the set screw relative to the spacer as shown.



Important Notes:

The set screws are a tight fit.
To push the set screw into the spacer, place cardboard on a solid surface then slowly and carefully push the spacer onto the set screw.

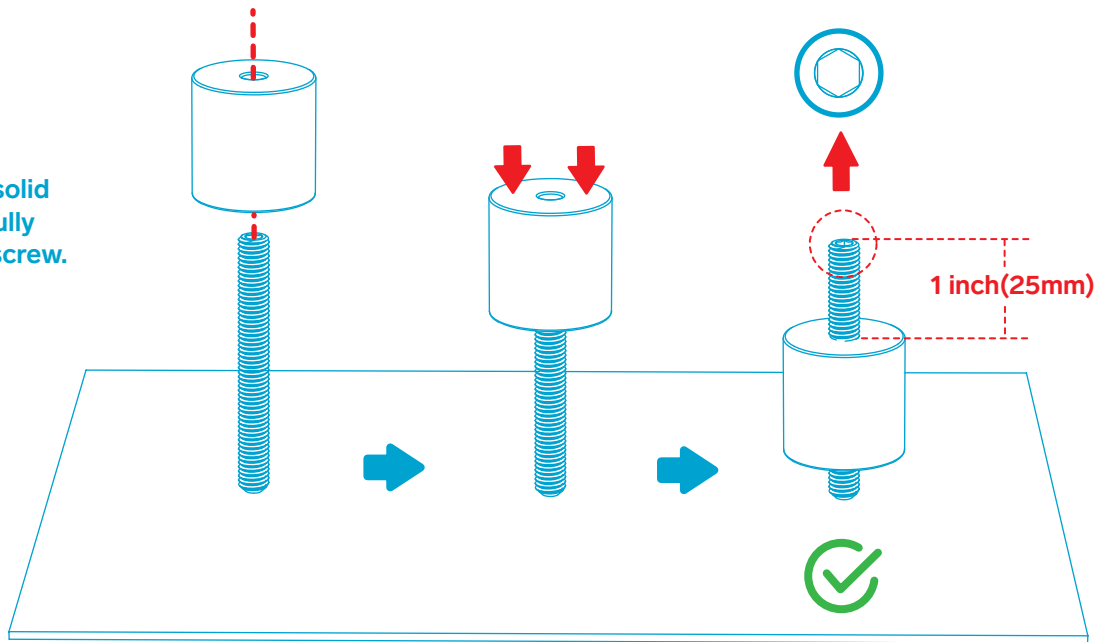

STEP 9

Fasten the mounting hardware to the display.



Important notes:

1. Fasten the set screw into the display at the depth recommended by the display manufacturer. Do not over-tighten these mounting screws.
2. Ensure the spacers rest snugly against the rear surface of the display.
3. The hex drive of each set screw should face away from the display.

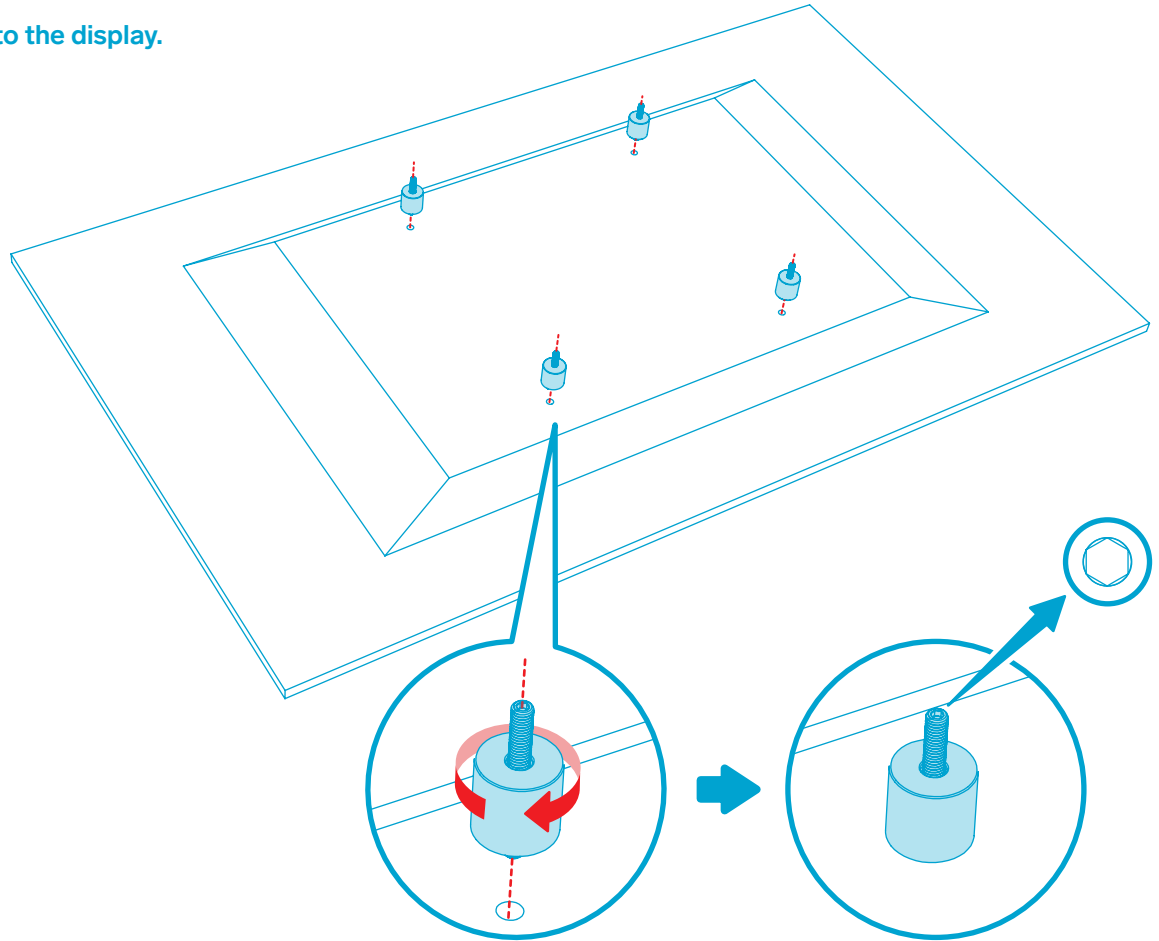

Note

If your display feature a curved rear surface, the display likely shipped with special mounting spacers. If so, use the display manufacturer's mounting spacers rather than the spacers included with Heckler AV Cart Prime.

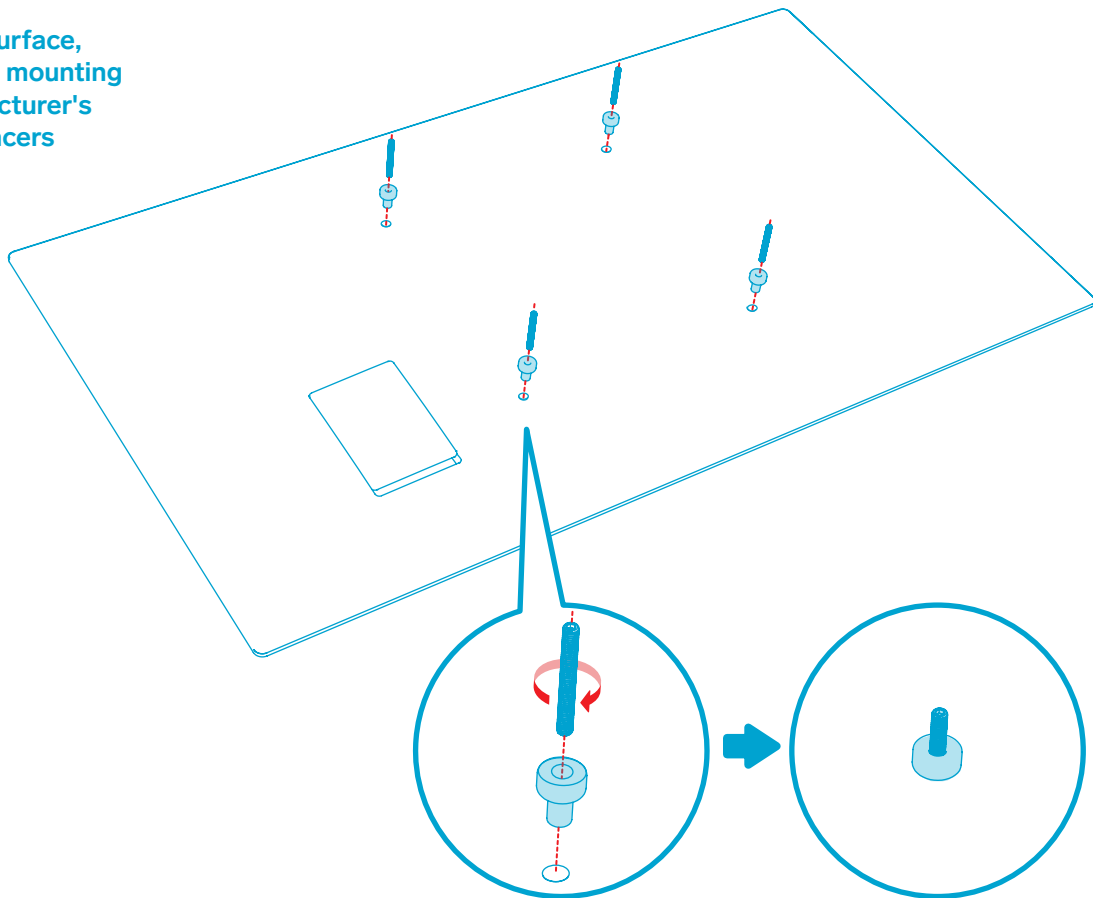
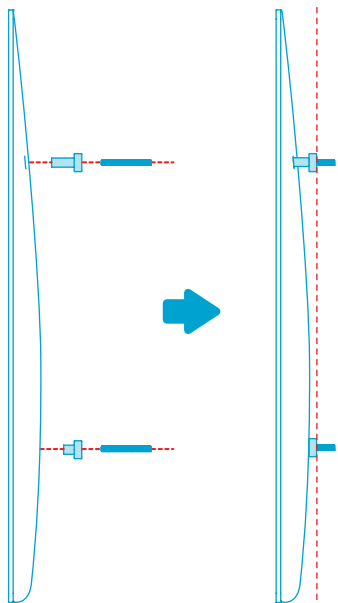
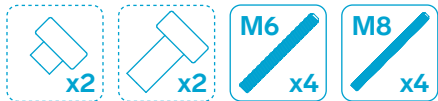

STEP 10

Ensure all caster brakes are engaged.

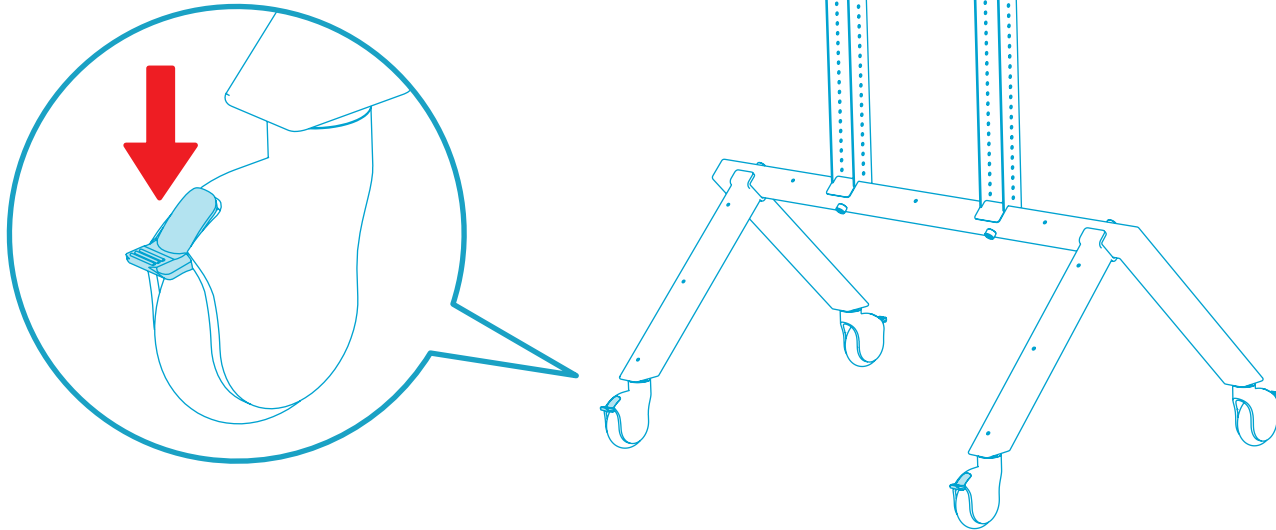

STEP 11

Install the display to
Display Rails by
fastening wingnuts.

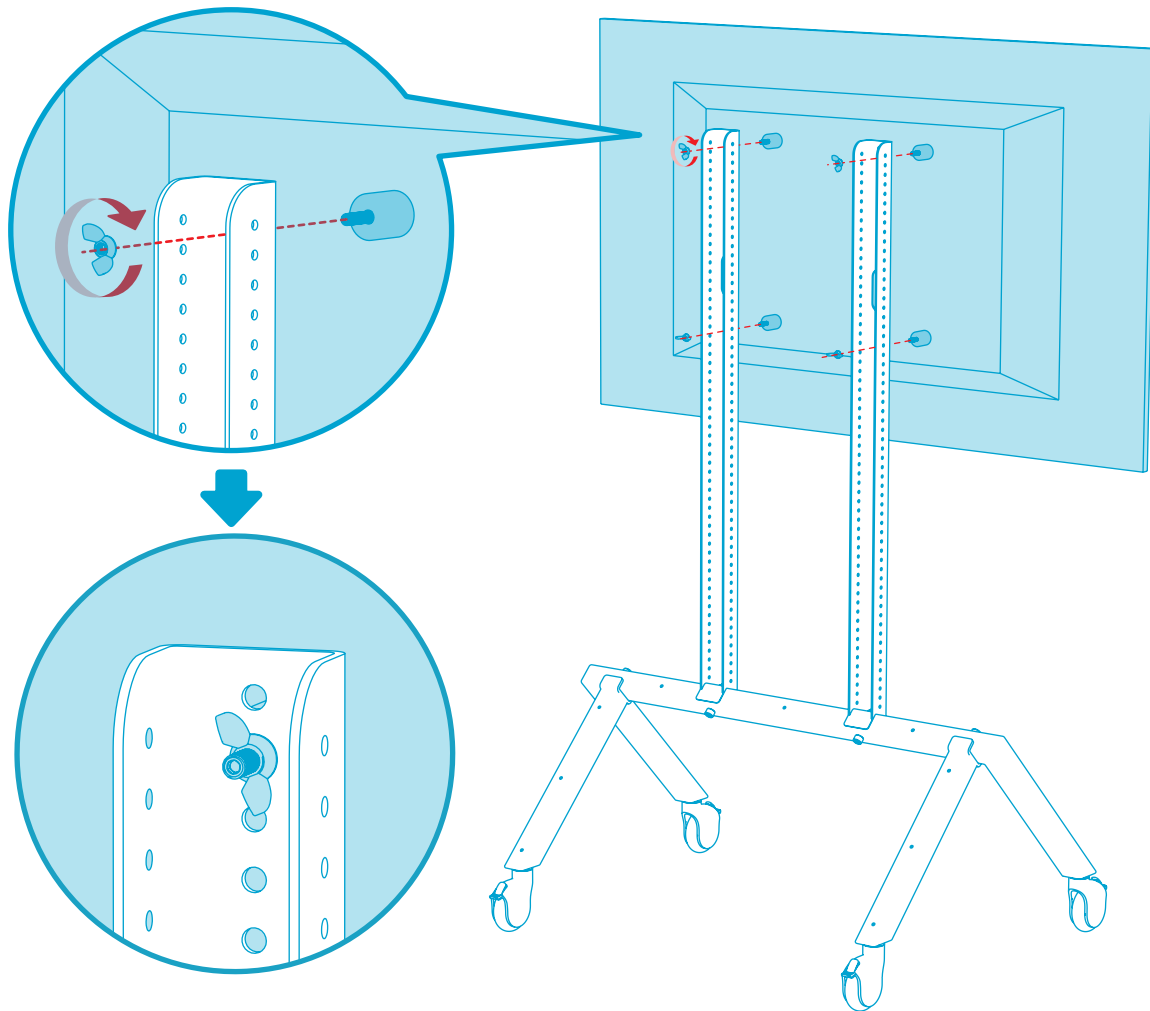
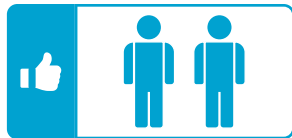

STEP 12

Route power and data cables inside each Display Rail as shown.

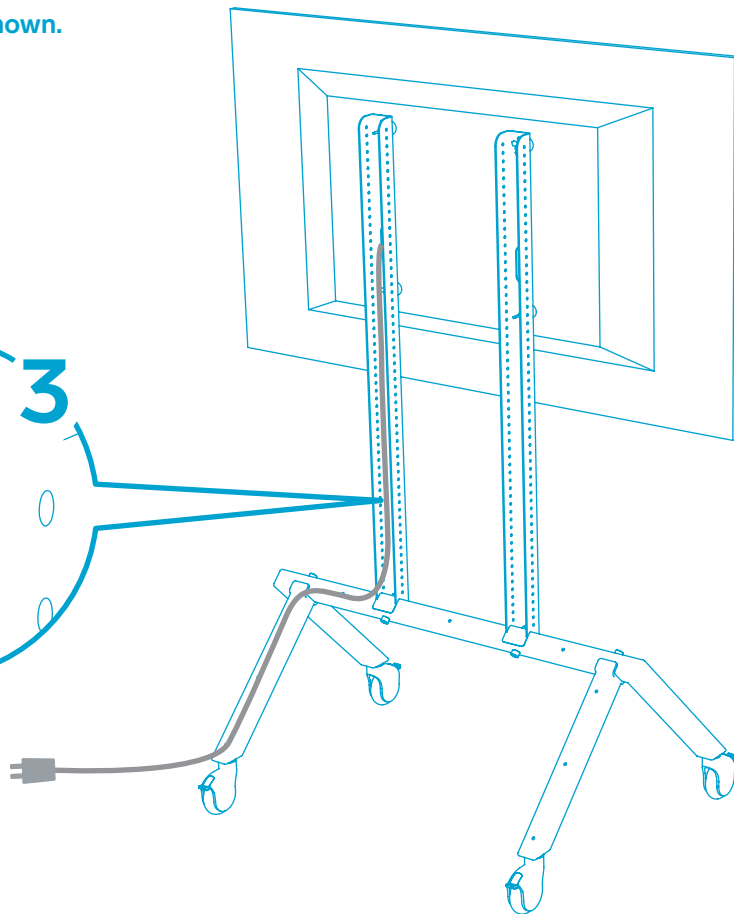
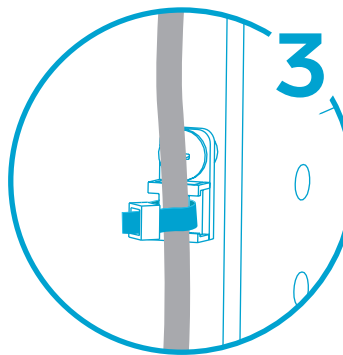
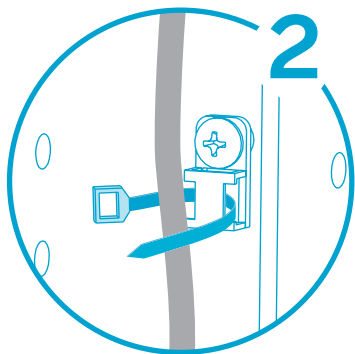
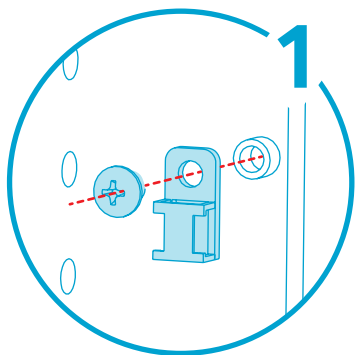

STEP 13

Route power and data cables along the Rear Leg as shown.

