



# OWNER'S MANUAL

## Viper 150 Dirt Bike

No one under the age of 16 should operate this Dirt bike without adult supervision. Parents should consider child's age, size, maturity and ability before allowing to ride.

Max. Weight Limit: 250lbs. (113kg)



Always wear a helmet; It could save your Life!

This manual should be considered as a permanent part of the vehicle and should remain with the vehicle when resold or otherwise transferred to a new user or operator. The manual contains important safety information and instructions which should be read carefully before operating the vehicle.

Please obtain, review, and follow the municipal, provincial and government acts and regulations pertaining to owning and operating an off-road vehicle.

Congratulations on your purchase of the Ricky Power Sports LLC. Viper 150 Dirt Bike. Your bike is warranted to be free of manufacturing defects in the material and workmanship for a period of 90 days from the date of purchase. During the warranty period Ricky Power Sports LLC. will at its option, repair, provide replacement parts or replace your Ricky Power Sports LLC. Viper Dirt bike at no charge. This warranty does not cover normal wear items or damage caused by neglect or misuse of the product.

Engine Warranty – 90 days

Frame Warranty – 90 days

Warranty is void if:

Frame is bent or broken due to abuse

Wheels are bent or broken

Fender bent or broken due to abuse

Any sign of impact, accident, jumping, spin-outs or roll over.

Ricky Power Sports LLC. is not liable for any damage claim or liability claim person or otherwise resulting from the operation of this product in any way.

Should you experience a problem with your vehicle, please call Ricky Power Sports LLC. customer service line toll free at 1- 844-250-2199. You will be instructed how to proceed.

**A COPY OF THE SALES RECEIPT IS REQUIRED.**



**WARNING**

**This manual should be considered as a permanent part of the vehicle and should remain with the vehicle when resold or otherwise transferred to a new user of operator. The manual contains important safety information and instructions which should be read carefully before operating the vehicle.**

# TABLE OF CONTENTS

NOTICE TO USER'S.....	2
SAFE OPERATION.....	3
PRE-RIDE CHECKLIST .....	4
SAFTY GEAR .....	5
LOCATION OF WARNING LABLES.....	6
MAIN DATA.....	7
PARTS & SUBASSEMBLES.....	8
OPERATION .....	9
FUEL VALVE .....	9
ENGINE STARTING.....	10
CARBURETOR DAMPER SWITCH .....	11
BREAKING IN THE ENGINE.....	11
SWITCHES ON RIGHT HANDLEBAR.....	11
GEAR SHIFTING .....	11
CHECK-UPS, ADJUSTMENT AND MAINTENANCE.....	12
CHANGING THE OIL, CLEANING OIL FILTER SCREEN .....	13
CHECK-UP OF SPARK PLUG .....	14
VALVE INSPECTION.....	14
CHECKING & CLEANING THE AIR FILTER .....	14
ADJUSTING THE THROTTLE CABLE.....	15
ADJUSTING THE CARBURETOR.....	16
INSPECTION OF FRONT HYDRAULIC DISK BRAKE.....	16
CLUTCH ADJUSTMENT .....	17
ADJUSTMENT OF CHAIN .....	18
GREASING PROCEDURES TO THE DRIVING CHAIN .....	19
TROUBLESHOOTING.....	19
FUEL SUPPLYING CHECK.....	19
IGNITION SYSTEM CHECK.....	20
VEHICLE WASHING.....	21
INSTRUCTIONS FOR STORAGE.....	21
RESUMPTION OF SERVICE AFTER STORAGE.....	22
TABLE OF TORQUE OF FASTENERS.....	22
MAINTENANCE SCHEDULE .....	23
RESUMPTION OF SERVICE .....	24
INSPECTION AND MAINTENANCE .....	24
SERIAL NUMBER LOCATION .....	25
WIRE DIAGRAM.....	26
RICKY POWER SPORTS, LLC. – EMISSION CONTROL SYSTEM WARRANTY.....	27

## NOTICE TO USER'S

Please read this manual and follow all instructions carefully. To emphasize special information, the symbol ▲ and the words WARNING or CAUTION have some special meanings. Pay great attention to the messages.

### ▲WARNING

- Indicates a potential hazard that could result in death or injury.

### ▲CAUTION

- Indicates a potential hazard that could result in vehicle damage.

**NOTE: Indicating special information which is to make maintenance easier or instructions clearer.**

**WARNING** and **CAUTION** are arranged like this:

### ▲WARNING-OR-CAUTION

- The first part will identify a POTENTIAL HAZARD.
- The second part will describe WHAT COULD HAPPEN if you ignore the WARNING or CAUTION.
- The third part will describe HOW TO AVOID THE HAZARD.

This user's manual contains important safety and maintenance information.

Read it carefully before riding. Failing to follow the warnings contained in this manual could result in INJURY or DEATH.

It is important that this manual remain with the vehicle when you transfer it to another user or owner.

All information, illustrations, photographs and specifications contained in this manual are based on the latest product information available at the time of publication. Due to improvements or other changes, there will be some discrepancies in this manual. We reserve the right to make product changes at any time, without notice and without incurring any obligation to make the same or similar changes to the vehicle previously built or sold.

## **SAFE OPERATION**

A pre-operation check must be conducted before starting the engine.

This check will insure safety, prevent mishaps, and prevent damage to components.

It is strongly suggested that all operators take a certified motorcycle rider's course prior to operating the vehicle.

Full attention is required during driving; paying close attention to the following points to avoid any injury to you by other motorized vehicles:

- Do not drive too close to other vehicles.
- Never carry a passenger. This dirt bike is for one operator only.
- Never operate this dirt bike at night. Night is defined as the period of time 30 minutes before sunset to 30 minutes after sunrise.
- Driving at high speeds is the cause of many accidents; do not drive at a speed that the actual situation does not permit.
- Always avoid operating this dirt bike on paved surfaces, including; sidewalks, paths, parking lots, driveways, streets, roads, and highways.

Never operated this or any Off-Road Vehicle on a public street, road or highway where motor vehicles are in operation.

## **PRE-RIDE CHECKLIST**

1. Engine oil level
  - a) Check for leaks
  - b) Tighten filler cap securely.
  - c) Add oil if required.
2. Fuel level
  - a) Add fuel as necessary.
  - b) Do not overfill (no fuel in the filler neck).
  - c) Do not mix oil with gas.
  - d) Replace cap tightly.
  - e) Do not refuel a hot engine. Allow engine to cool before adding fuel.
3. Warning decals
  - a) Make sure all warning decals are legible and securely attached.
  - b) Replace as necessary.
4. Tires
  - a) Ensure that both tires are in safe riding condition.
  - b) Properly inflate both tires. We recommend that you inflate the front tire to 15 psi and the rear tire to 20 psi. Do not exceed 32 psi.
5. Drive chain
  - a) Check condition and tension.
  - b) Lubricate and adjust tension as necessary.
6. Throttle
  - a) Check for smooth operation. Make sure the throttle "snaps" back to idle.
  - b) Check for frayed cable or damaged cable housing. Replace damaged cable.
  - c) Check for mud, debris and ice in the throttle cable/mechanism.

Clean out any contamination.

## SAFTY GEAR

A DOT approved motorcycle helmet is the most important part of you safety gear. A DOT approved motorcycle helmet can help prevent a serious head injury. Choose a helmet that fits snugly. Motorcycle dealers can help in selecting a good quality helmet which fits properly.

### **▲WARNING**

- Operating this motorcycle without wearing an approved DOT motorcycle helmet, eye protection, and protective clothing could be hazardous.
- Operating without an approved DOT motorcycle helmet or eye protection increases your chances of a severe head injury or death in an accident. Operating without protective clothing also increases your chances of sever injury in an accident.
- Always wear an approved DOT motorcycle helmet which fits properly. Always wear eye protection (goggles or face shield). You should also wear gloves, boots, long sleeve shirt or jacket, and long pants.

You should wear eye protection when you ride. If a rock or a branch hits your eyes, you could be severely injured. Wear goggles or a face shield.

Wear proper clothing when you ride. The proper clothes can protect you from injury. Wear a good pair of gloves, strong boots that are over the ankle, long pants, and a long sleeve shirt.

## LOCATION OF WARNING LABELS

Read and follow all of the warnings labels on your Dirt bike. Make sure you understand all the labels. Keep the labels on the Dirt bike. Do not remove them for any reason. If a label come off or become difficult to read, you should get a replacement by contacting Ricky Power Sports LLC.



1

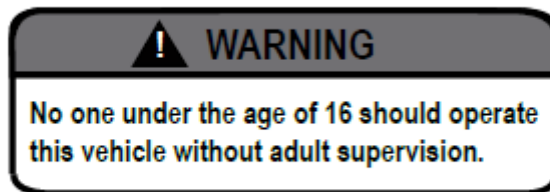

2

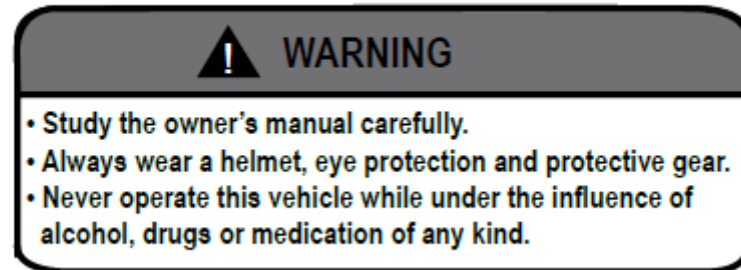



## MAIN DATA

DESCRIPTION	DATA	DESCRIPTION	DATA
Overall length	1540mm	Cylinder bore x stroke	62mm x 49.5mm
Overall width	640mm	Compression ratio	9.0 : 1
Overall height	880mm	Related Power	8.0Kw/8500rpm
Wheelbase	1270mm	Related torque	10.0N.m/6500rpm
Curb mass	92Kg	Idle speed	1500±150 r/min
Payload	113Kg	Displacement of cylinder	149cc
Ground Clearance	230mm	Spark plug	D8RTC (Torch) Gap:0.6~0.8mm
Max speed	80Km/h	Front wheel	70/100-19
Transmission	5 gear mesh	Rear wheel	90/100-16
Capacity of fuel tank	6.0L	Ignition means	C.D.I.
Oil capacity	1.0L	Brake	Front: Disc Rear: Disc
Lubrication method	Pressure, splash	Clutch	Manual / wet

## PARTS & SUBASSEMBLES

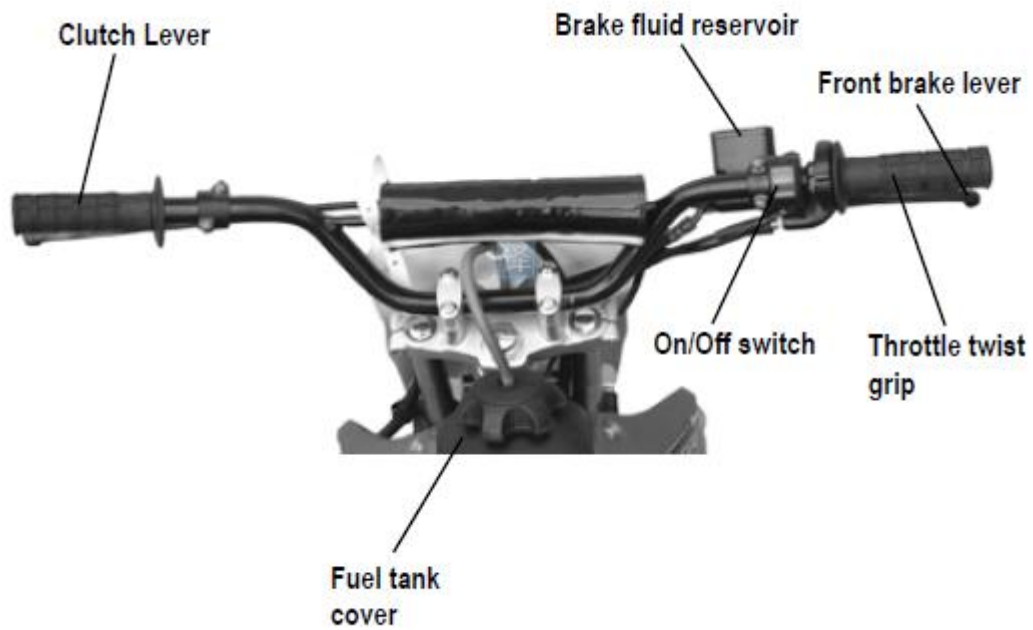

### Viper



## OPERATION

### FUEL VALVE

#### Fuel filling

The capacity of the fuel tank is 6.0L. Unscrew the gas cap by turning it counter clockwise and carefully fill the tank with unleaded gasoline through the opening. DO NOT MIX GAS AND OIL TOGETHER, THIS IS A 4-STROKE ENGINE. Replace the gas cap by carefully aligning the threads on the cap and the tank and turning the cap clock wise. Wipe any spilled fuel from the dirt bike using a cloth and dispose of the cloth properly. DO NOT SMOKE OR REFUEL THE VEHICLE NEAR OPEN FLAMES OR NEAR HEATING UNITS.

ONLY REFUEL THE VEHICLE IN OPEN AREAS TO REDUCE THE LIKELIHOOD OF THE BUILD UP OF GASOLINE FUMES.

Operation of the fuel valve (the valve under the fuel tank)

**ON:** With the handle of the fuel valve at "ON" position, the fuel supply will flow to the carburetor.

**OFF:** With the handle of the fuel valve at "OFF" position, the fuel supply will not flow to the carburetor.

**RES:** If fuel level in the fuel tank becomes too low for engine to stay running while fuel valve is at "ON" position, turn fuel valve to "RESERVE". Turning fuel valve to "RESERVE" will allow engine to begin using reserve fuel supply.

You will need to re-fuel as soon as possible. There is approximately 1L of fuel left in tank when fuel valve is placed at "RESERVE". Once re-fueled, turn fuel valve back to the "ON" Position.



Fuel Valve ON



Fuel Valve OFF



Fuel Valve RESERVE

## ENGINE STARTING

### ⚠ CAUTION

- Verify oil level prior to starting.
- Starting the engine with low or no oil will damage the engine.

### ⚠ WARNING

- Never start the engine in a closed place as the exhausted gas from the vehicle contains toxic carbon monoxide.

1. Set the key of the ignition switch to  position.
2. Put the dirt bike in the neutral gear.
3. Ensure that there is fuel in the tank.
4. Set the fuel valve handle to "ON" or "RES" position.

To start a cold engine:

1. Pull up the choke lever of the carburetor (to close the choke).
2. Start the engine with kick lever.
3. Slightly turn the throttle twist grip to increase the speed of the engine so as to warm up the engine.
4. Turn the carburetor choke bar downward to fully open the choke when the engine is sufficiently warmed up.

### ⚠ CAUTION

- Unnecessarily increasing RPM's to a high level while the motorcycle is in neutral is harmful to the engine.

Procedures for stopping the engine:

1. Release the throttle twist grip to slow down the engine.
2. Shift to the neutral position.
3. Set the ignition switch key to  position.
4. Set the fuel valve handle to "OFF" position.

## CARBURETOR DAMPER SWITCH

When starting the whole vehicle, close the carburetor damper switch (see Figure 1); After starting, continue to refuel the throttle for 1 to 2 minutes or after the engine temperature rises by 45 °, the idle speed is stable, and then open the carburetor damper switch (see Figure 2).



Figure 1



Figure 2

## BREAKING IN THE ENGINE

The first 600 Miles of operation should be considered the "Break-in" period and special attention shall be paid to the following points:

1. Take special care not to increase the RPM's of the engine while climbing steep slopes. Never drive your dirt bike continuously for more than 50km (30 miles) without increasing and decreasing the throttle.
2. The engine shall be warmed up for 3-5 minutes prior to operation so all components are lubricated sufficiently.
3. The driving speed shall not be over 40 kmph (25 MPH) maximum during the first 500 km (300 miles) of operation and not over 65 kmph (40 MPH) maximum during the remaining 500 km (300 miles) of the "Break-In" period.

## SWITCHES ON RIGHT HANDLEBAR

### Ignition switch

The ignition switch is Located on the right handlebar.

When the switch is turned to  (off) position, the engine will not start. If the engine is running and the Off button is pushed the engine will turn off.

When the switch is turned to  (on) position, the engine can start by using the kick start lever.

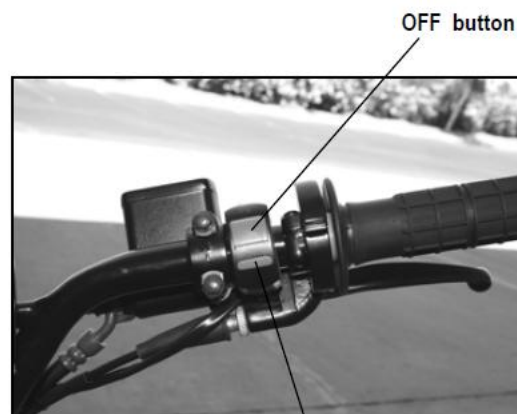

ON button

## GEAR SHIFTING

Reduce throttle before shifting. Never increase the throttle while shifting gears.

Pull in the clutch lever, located on the left hand grip.

Depress the Shift lever to place the gear in 1st, lift up the lever to shift to 2nd, 3rd, 4th and 5th.

Do not place your foot on the gear-shifting pedal while operating the dirt bike to avoid clutch damage caused by accidental gear shifting.

Clutch lever



### Shifting sequence

- (1) 1st gear
- (N) Neutral
- (2) 2nd gear
- (3) 3rd gear
- (4) 4th gear
- (5) 5th gear

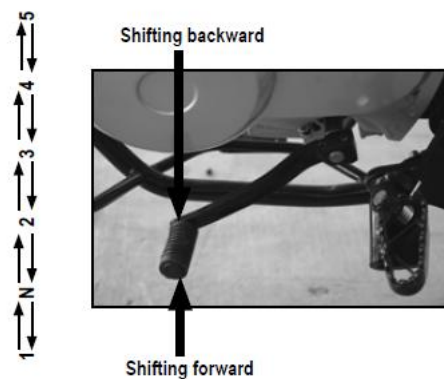

### Points for Attention during Drive

1. To warm the engine let engine idle. Do not rev the engine to prevent damage to the engine components.
2. The clutch will wear out quickly if the dirt bike is operated with the clutch in a semi-engaged position.
3. Shift to the low speed gears when you feel that there is insufficient power to climb hills or continue forward.
4. Do not use the front brake only or coast using the neutral gear especially when descending or driving at a high speed.
5. Decrease the throttle when braking.

## CHECK-UPS, ADJUSTMENT AND MAINTENANCE

### Checking the Oil

Check the engine oil each time prior to operating the dirt bike.

The oil level should be between the upper and lower lines of the oil sight gauge located on the right cover of the crankcase. The level can also be checked on the dip stick.

1. Set the motorcycle on level ground, look at the sight gauge for current oil level. Remove the oil gage plug, wipe the oil gage rod clean and then insert the gage plug into the crankcase again to check the oil level. There is no need to completely install the oil gage plug in the crankcase fill hole.
2. Add lubricating oil up to the upper line when needed, but do not overfill.
3. Finally screw on the oil gage plug tightly.



Oil fill cap and dip stick



Oil sight gauge

### ▲ CAUTION

- Never start the engine when there is insufficient lubricating oil. Otherwise, it will cause harm to the engine.

### Lubricating Oil Recommended

The lubricating oil is an important factor affecting the performance and service life of the engine. Please refer to the chart for the correct grade of engine oil based on the environmental conditions in your area. Do not use any other type of oil other than what is recommended in the chart. **DO NOT MIX OIL WITH THE GASOLINE.**

Lubricating oils of different viscosity shall be employed in different regions and at different temperatures.

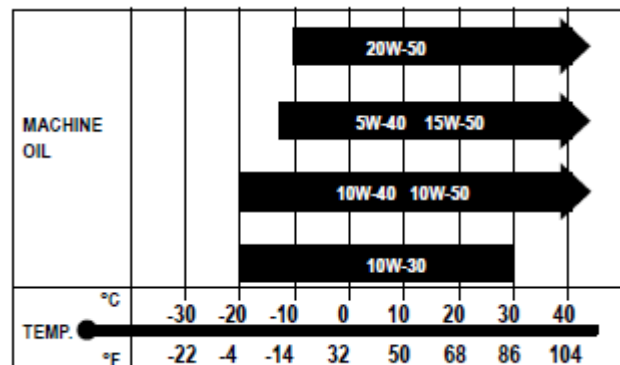

### CHANGING THE OIL, CLEANING OIL FILTER SCREEN

1. of the engine and let the oil drain into an approved collection container.

DO NOT PERFORM THIS PROCEDURE WHILE THE ENGINE IS HOT.

SERIOUS BURNS COULD RESULT FROM CONTACT WITH HOT OIL.

2. Dispose of the used oil properly. For proper disposal procedures, contact your local oil recycling center.

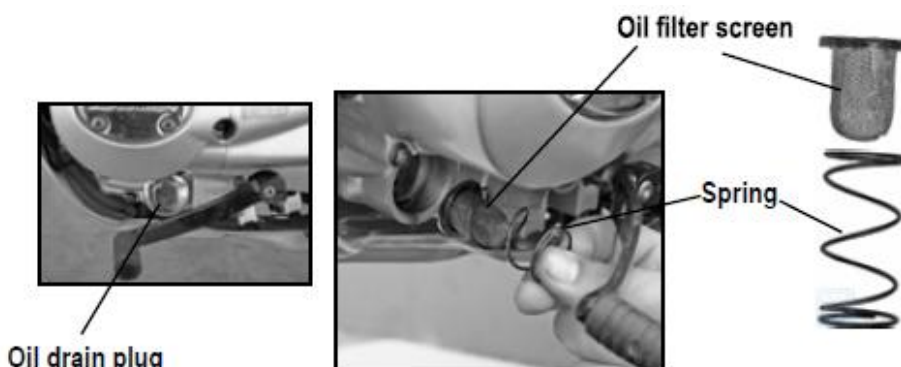

3. Clean oil screen and spring with solvent.
  4. Clean and replace the oil drain plug making sure it is secure.
- Oil in the engine by using the oil gauge plug and/or sight gauge.

## CHECK-UP OF SPARK PLUG

1. Remove the cap of spark plug and screw off the spark plug using the plug wrench.
2. Clean the spark plug all around or replace it if it is corroded or there is too much deposit on it.
3. Regulate the gap of the spark plug to 0.6-0.8mm. (.024 inches - .032 inches)

The spark plug of the designated type should be used. The applicable type of spark plug: D8RTC (Torch) or equivalent



## VALVE INSPECTION

Refer to maintenance schedule in this owner's manual for valve adjustment inspection intervals .

Valve clearance should be:

Intake: 0.02-0.03mm

Exhaust: 0.03-0.05mm

The engine will make excess noise if the gap is too large in air valve. If gap is too small valve operation will be hindered which could result in valve malfunction and failure. Therefore, air valve gap must be checked periodically.

If you have the proper tools and are mechanically proficient, instructions on adjusting the valve clearance are given in the service manual. If assistance is needed please contact Ricky Power Sports LLC. to find your local service center.

## CHECKING & CLEANING THE AIR FILTER

Air filter is located under left side plastic cowling. Cowling will need to be removed.

Take the air filter out and check to see if it is dirty or torn.

Remove foam element and wash with water and allow it to dry per instructions below.

Apply a few drops of machine oil. Squeeze it with a dry cloth to remove excess oil.

Recommended oil: SAE 15W-40

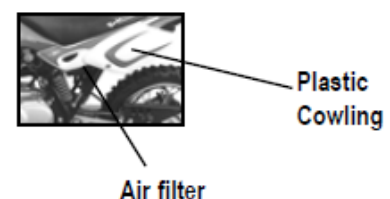



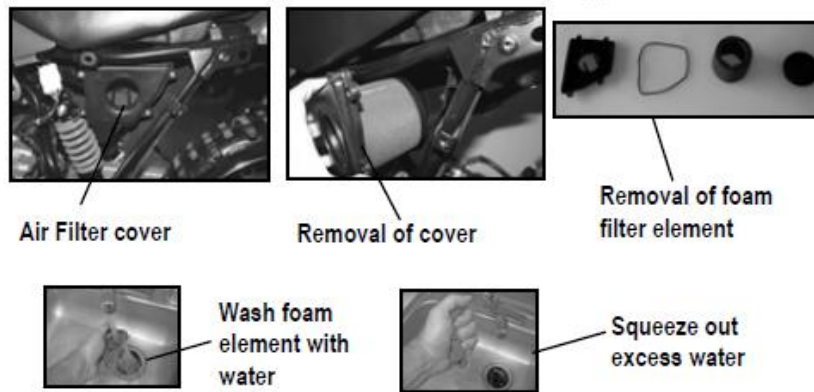

### ▲ CAUTION

- The air filter element must be intact or the engine will suck in dust and dirt, resulting in a shorter service life of the engine.
- Water should be prevented from entering into the filter when washing the vehicle.
- The filter element shall be cleaned gently without twisting to prevent it from cracking. Never wash it with gasoline or acid, alkaline or organic volatile oil to avoid its aging, which will result in reducing the effect of the air filter oil to catch particles before they enter the engine. Replace the filter element with a new one if it is broken or cracked.

## ADJUSTING THE THROTTLE CABLE

Make sure the throttle works normally.

Check if the throttle twist grip has the required free operating movement.

The required free operating movement: 2-6mm (0.078 inches - 0.24 inches) If the grip cannot be moved freely, turn the adjusting nut located on top of the throttle twist grip to ensure proper operating movement.

After adjustment, start the engine and check for the operating movement again. Repeat the adjustment if necessary until the desired operating movement is obtained.

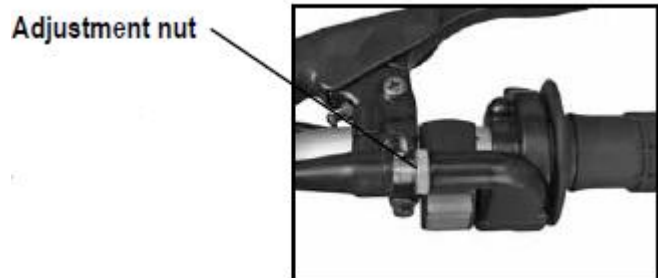

## ADJUSTING THE CARBURETOR

Adjusting procedures of idling speed:

1. Support the vehicle by a stand.
2. Adjust the idling speed by the special designed tool to  $1500 \pm 150$ r/min.

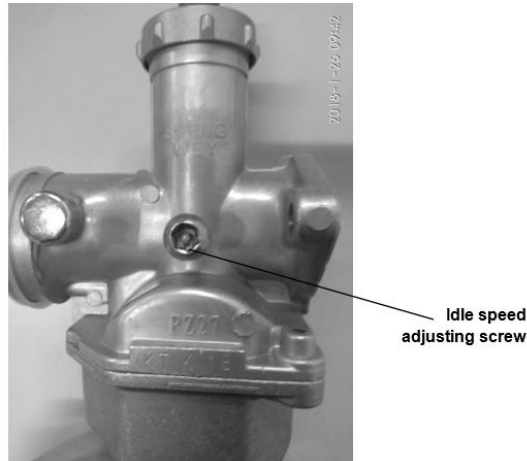

### CAUTION

- Do not try to correct a malfunction carburetor by adjusting the idling speed. If the carburetor is not functioning properly, it should be repaired by dealer.
- Adjust idling speed only when the engine is warmed up or 10 minutes after operation.



## INSPECTION OF FRONT HYDRAULIC DISK BRAKE

1. Inspect the front disk brake caliper for leakage. If brake fluid leaks, the safety of riding could be affected.
2. Inspect the brake hose for cracks, and the joint for leakage.

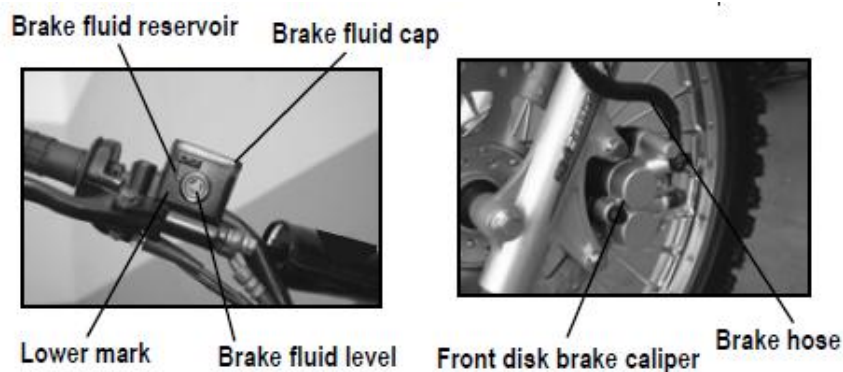

3. Check the brake fluid level in the brake fluid reservoir, if level is at or below the LOWER mark, inspect brake pads for wear and hydraulic system for leaks.
4. To add brake fluid, unscrew the 2 screws on top of the brake fluid container. Add DOT3 or DOT4 brake fluid. Do not mix brake fluid types.

#### FRONT HYDRAULIC DISK BRAKE INSPECTION REAR HYDRAULIC DISK BRAKE INSPECTION

1. Inspect the rear disk brake caliper for leakage. If brake fluid leaks, the safety of riding could be affected.
2. Inspect the brake hose for cracks, and the joint for leakage.
3. Check the brake fluid level in the brake fluid reservoir, if level is at or below the LOWER mark, inspect brake pads for wear and hydraulic system for leaks.
4. To add brake fluid, unscrew cap on top of brake fluid container. Add DOT3 or DOT4 brake fluid. Do not mix brake fluid types.

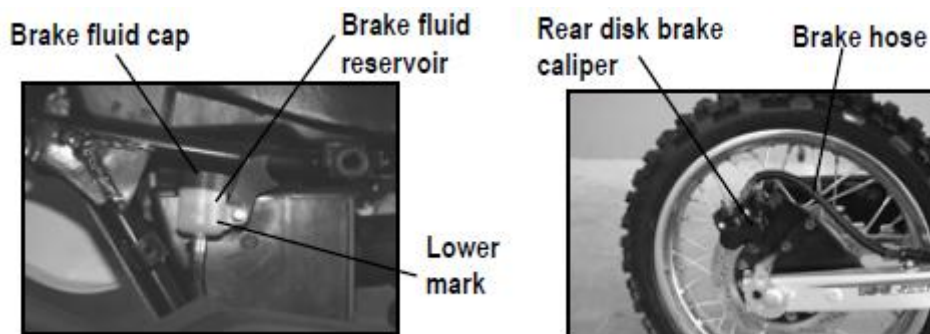

## CLUTCH ADJUSTMENT

To adjust the clutch lever play:

1. Remove the adjuster cover (slide back on cable).
2. Loosen adjuster nut and move adjuster in or out to obtain the correct play.
3. Tighten adjuster nut
4. Recheck the clutch lever free distance.

Readjust it if it is not within the correct limits.

To adjust the clutch:

1. Loosen adjuster nut and move adjuster in or out to obtain the correct tension.
2. Tighten adjuster nut
3. Recheck the clutch lever free distance.

Readjust it if it is not within the correct limits.

Clutch lever adjustment nut

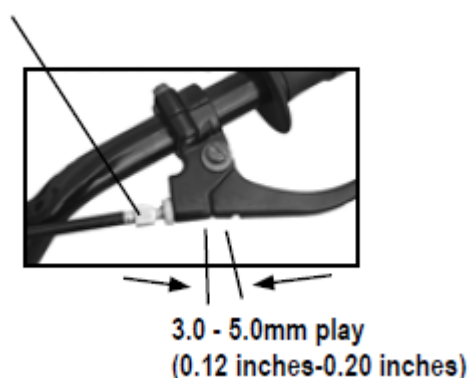

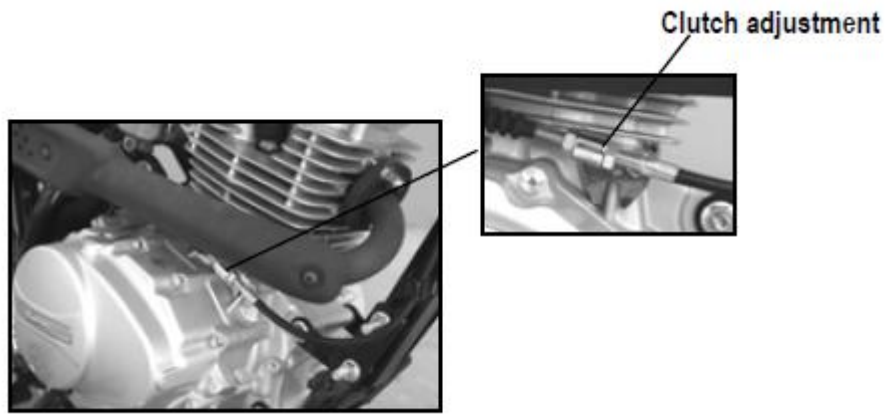

## ADJUSTMENT OF CHAIN

1. When chain adjustment is needed, loosen rear axle nut .
2. Turn the chain adjusting brackets on the left and right sides to adjust the tension of the chain and to align the marking of the chain adjuster with the engraved lines in the similar position on both sides.
3. Tighten rear axle nut by a torque of 50-60Nm (37-44 ft.lb.).
4. Repetitively check the tension of the chain.

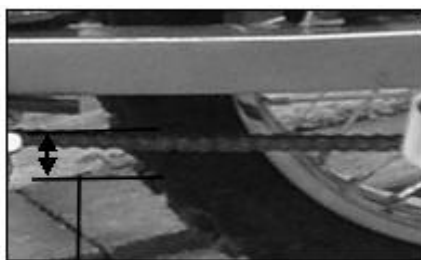

15-20mm  
1/2 inches-1/3 inches



Chain adjusting brackets



Rear axle nut

Adjustment marks  
Located on each side  
of Dirt Bike

## GREASING PROCEDURES TO THE DRIVING CHAIN

1. Shut off the engine
2. Add light amounts of machine oil or chain grease to the driving chain.

(Too much machine oil or chain grease may cause splattering to occur.)

Attention:

The chain should be replaced when the adjusting limit has reached it's maximum.

## TROUBLESHOOTING

This troubleshooting guide is provided to help you to find the cause of some common complaints.

**COMPLAINT:** Engine is hard to start or does not start at all. Something is probably wrong with the fuel system or ignition system.

### ▲ CAUTION

- Failing to troubleshoot a problem correctly would damage your motorcycle.
- Improper repairs or adjustments may damage the vehicle. Such damage may not be covered under warranty. If you are not sure about the proper action, consult your dealer. About the problem.

## FUEL SUPPLYING CHECK

1. Make sure there is adequate fuel in the fuel tank.
2. Check that the engine stop switch is in the "RUN " position.
3. Check that the fuel valve is in the "ON" position.
4. Make sure there is enough fuel reaching the carburetor from the fuel tank.

### ▲ WARNING

- Draining fuel from the carburetor could be hazardous.
- Fuel could catch fire if you do not handle it properly.
- When draining the carburetor, be sure to shut the engine off. Do not smoke, and never drain or refuel or you may create a fire hazard. Dispose of drained fuel properly.

- a. Loosen the drain screw which is located under the carburetor. Drain the fuel from the carburetor into a container.
- b. Tighten the drain screw.
- c. Run the engine for a few seconds. Shut off engine.
- d. Loosen the drain screw and check that the carburetor is filled back up with fuel.
- e. If fuel is reaching the carburetor, the ignition system should be checked Next.

## IGNITION SYSTEM CHECK



1. Remove the spark plug and reattach it to the spark plug lead.
2. Turn ignition key to the "RUN" position. Slide the engine stop switch to the "Run" position. Kick the start lever.

If the ignition system is operating properly, a blue spark should jump across the spark plug gap. If there is no spark, take your machine to your Service center.

### **▲WARNING**

- Performing the spark test improperly could be hazardous.
- You could get a high voltage electrical shock if you are not familiar with this procedure.
- Do not perform this check if you are not familiar with the procedure.
- Do not point the spark plug near the spark plug hole during this test.
- Do not do this test if you have a heart condition or wear a pacemaker.
- Do not perform this test is any near any open fuel containers for near fuel which has spilled on the ground, on the engine, or any part of the motorcycle.

### **COMPLAINT: Engine stalls**

1. Make sure there is enough fuel in the fuel tank.
2. Check to see that the spark plug is not fouled. Remove the spark plug and clean it. Replace it, if necessary.
3. Make sure the fuel valve is not clogged, and the fuel tank is not clogged, either.
4. Check the idle speed. If necessary, adjust it using a tachometer. The correct idle speed is  $1500 \pm 150$  r/min.
5. Make sure the air filter is clean.

## VEHICLE WASHING

Cleaning the vehicle regularly can slow down the color fading of its body and make it easier to check if there is any damage and any oil leakage.

### ▲ CAUTION

- Washing the motorcycle with over-pressurized water may cause damage to some of its components. Therefore, do not use a pressure washer to clean the vehicle. The following parts should be cleaned using low pressure water:

- Wheel hub
- Exhaust pipe
- Fuel tank and lower portion of cushion
- Carburetor
- Ignition Switch
- Air filter

1. After pre-wiping, the vehicle should be washed with clean water to remove dirty residues so as to prevent corrosion. Plastic subassemblies should be cleaned by wiping with a cloth or foam soaked in neutral detergent solution, followed by washing with clean water.
2. After the cleaned vehicle is air dried, grease the chain and run the engine at idling speed for a few minutes.
3. Prior to driving, carefully check the braking system repeatedly and repair or adjust it if necessary.

## INSTRUCTIONS FOR STORAGE

If the vehicle is not going to be used for a long period of time, for example, in winter time, some steps should be taken to prevent malfunction of and damage to its components which might be caused by long storage. Before storing the vehicle for a long period, proper maintenance has to be done.

1. Change engine oil and clean oil and air filters.
2. Drain off fuel from the fuel tank and carburetor, spray atomized anti-rust oil onto the inside wall of the tank and then close the tank. Dispose of any drained fuel properly so as not to adversely affect the environment.

### Attention:

If the storage will last for more than one month, fuel in the carburetor must be fully drained. This will help ensure that the carburetor maintains its normal performance after the storage.

### ▲ WARNING

- Gasoline is flammable and may cause fire and even an explosion under certain conditions. Therefore, do not smoke, make a fire or have any fire around while draining off fuel.

3. Take out the spark plug, pour about 15-20ml (.5 - .68 oz.) of clean engine oil into the cylinder, step down on the kick lever several times so as to have machine oil distributed inside the engine and finally fit the spark plug back on.
4. Wash the vehicle clean, wipe it dry and apply an even coat of wax to the painted surface and a coat of anti-rust oil on the chrome-plated surfaces.
5. Inflate the tires as required and put the vehicle up on wooden blocks with the two wheels clearing the ground.
6. Put the vehicle in a shady and cool place free from humidity and direct sunlight and cover it properly (not with plastic or other painted materials).

If there is a garage, store it within.

## RESUMPTION OF SERVICE AFTER STORAGE

1. Remove the covering and remove the wooden blocks used in storing the vehicle. Change the engine oil if the vehicle has been out of service for over 4 months.
2. Drain off the remaining atomized anti-rust oil from the fuel tank, followed by filling it with fresh gasoline therein.
3. Prior to driving, all the required check-ups must be made. It is better to drive it at a low speed in an open area to test its performance before normal operation.

## TABLE OF TORQUE OF FASTENERS

Ser. No.	Fastener	Torque (Newton/m) (Foot/lb)
1	Nut for tightening upper joining plate of front fork with vertical tube	40~50Nm (30~37 ft.lb.)
2	Nuts for fixing engine	20~25Nm (15~18 ft.lb.)
3	Bolt for tightening upper joining plate of front fork with shock absorber	15~20Nm (11~15 ft.lb.)





## MAINTENANCE SCHEDULE

Item	Initial 1 months / 20hrs	Initial 3 months / 50hrs	Every 3 months / 50hrs	Every 6 months / 100hrs
* Valves	I			I
Spark plug		C	C	R
Valve clearance-Check-Adjust				I
Air filter	I Every 20~40 hours (more often in dusty areas)			
* Carburetor		I		I
* Exhaust system				I
Spark arrester				I
Fuel hose		I		I
Engine oil	R			R
Engine oil filter	C			C
Engine oil strainer	C			C
Brake fluid level	I	I	I	
Brake hose and joints		I	I	
Brakes	I	I	I	
Clutch	I	I	I	
Wheels	I			I
Wheel bearings	I			I
Brake caliper linings	I	I	I	
Front and rear suspension				I
Steering system	I	I	I	
* Steering shaft lubrication (use Li grease)				L
Fittings and Fasteners	T	T	T	

I=Inspect and clean, adjust, lubricate or replace, if necessary.

C=Clean R=Replace T=Tighten

\* Should be completed by an authorized service center

## **RESUMPTION OF SERVICE**

1. Remove the covering and clean the vehicle. Change the lubricating oil if the vehicle has been off service for more than 4 months.
2. Drain off the anti-rust solution from the fuel tank, followed by filling fuel therein to the required level.
3. Prior to driving, test the vehicle at a low speed in a safe place.

## **INSPECTION AND MAINTENANCE**

It is very important to inspect and maintain your Viper dirt bike regularly.

Follow the guidelines in the chart. The intervals between periodic services in months are shown. At the end of each interval be sure to perform the maintenance listed.

## SERIAL NUMBER LOCATION

You need to know the frame and engine serial numbers to get title documents for your Dirt Bike. You also need these numbers to help your authorized service center or Ricky Power Sports LLC. order parts.

The Frame number is stamped on front of Dirt bike frame. The engine number is located on the left side of the engine housing.

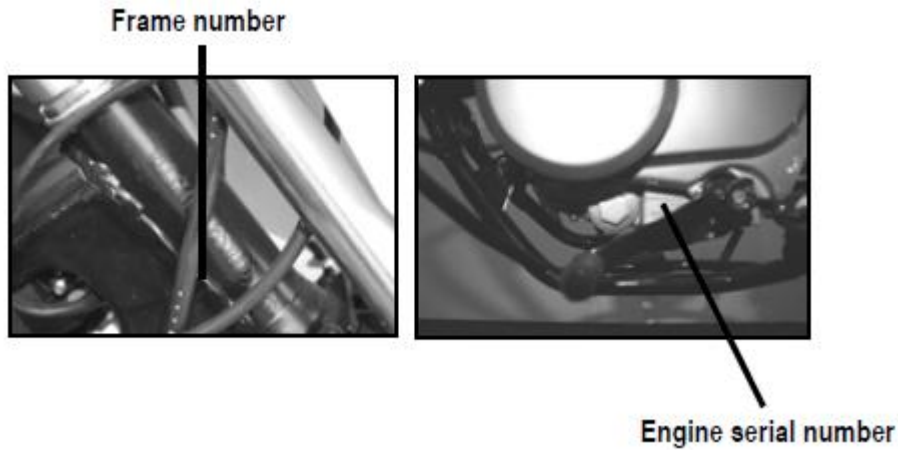

Write down the serial numbers here for your future reference :

Frame NO.:

Engine No.:

# WIRE DIAGRAM

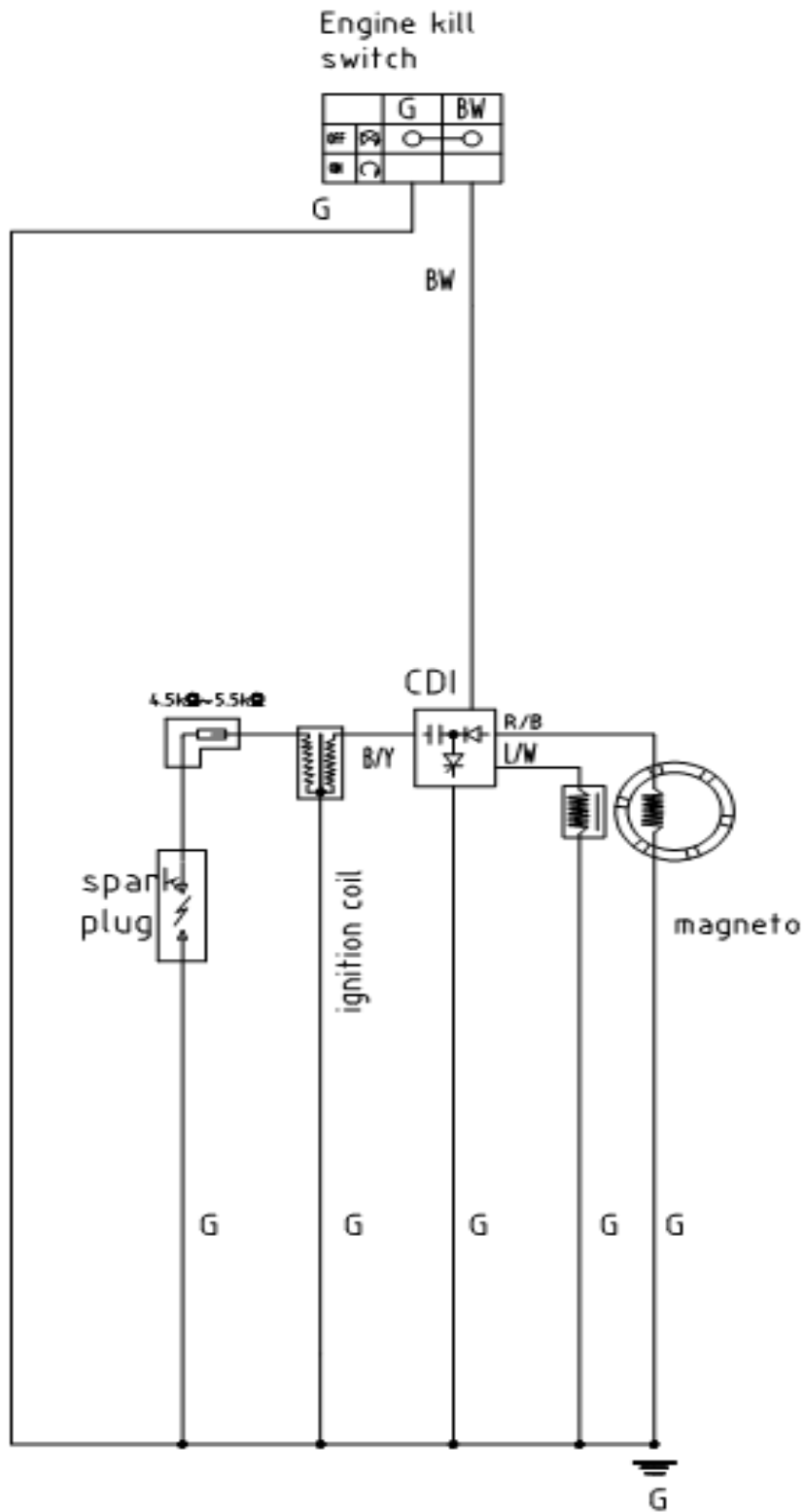

# **RICKY POWER SPORTS, LLC. – EMISSION CONTROL SYSTEM WARRANTY**

## **YOUR WARRANTY RIGHTS AND OBLIGATIONS**

The emission control system warranty period for this vehicle begins on the date the vehicle is delivered to the first purchaser other than an authorized dealer, or the date it is first used as a demonstrator, lease, or company vehicle, whichever comes first and continues for 30 months after that date, or 5,000km, whichever comes first, provided there has been no abuse, neglect or improper maintenance of your vehicle. Where a warrantable condition exists, Ricky Power Sports, LLC will repair your vehicle at no cost to you, including diagnosis, parts and labor. If an emission-related part on your vehicle is defective, the part will be repaired or replaced by the Ricky Power Sports, LLC. This is your emission control defects warranty.

## **OWNER'S WARRANTY RESPONSIBILITIES**

As the vehicle owner, you are responsible for the performance of the required maintenance. You should maintain a record of all maintenance performed on your vehicle and retain all receipts covering maintenance on your vehicle. You may not be denied a warranty claim solely because of your failure to ensure the performance of all scheduled maintenance or lack of maintenance records or receipts. You are responsible for presenting your vehicle to an authorized dealer as soon as a problem exists. The warranty repairs should be completed in a reasonable amount of time, not to exceed 30 days.

As the vehicle owner, you should be aware that you may be denied your warranty coverage if your vehicle or a part has failed due to abuse, neglect, improper maintenance, or unapproved modifications.

## **WARRANTY COVERAGE**

Ricky Power Sports, LLC warrants that each new 2022 and later vehicle:

- is designed, built, and equipped so as to conform at the time of initial retail purchase with all applicable regulations of the United States Environmental Protection Agency; and
- is free from defects in material and workmanship which cause such vehicle to fail to conform with applicable regulations of the United States Environmental Protection Agency for the periods specified above.

Your emission control system warranty covers components whose failure would increase an engine's emission, including electronic controls, fuel injection system, carburetor, the ignition system, catalytic converter, or any other system utilized in this vehicle to control emission if it is originally equipped. Also included may be hoses, connectors and other emission-related assemblies. Replacing or repairing other components (including parts, labor, and other costs) not covered by this emission control system warranty or the standard warranty is the responsibility of the owner.

Coverage of repairs under this warranty applies only when repairs are completed at an authorized dealer or repair facility. Ricky Power Sports, LLC will not cover repairs performed outside of an authorized dealer or repair facility.

The use of replacement parts not equivalent to the original parts may impair the effectiveness of your vehicle's emission control system. If such a replacement part is used and an authorized dealer determines it is defective or causes a failure of a warranted part, your claim for repair to bring your vehicle into compliance with applicable standards may be denied.

This Emission Control System Warranty is in addition to the standard Limited Warranty.

### **EXCLUSIONS AND LIMITATIONS**

This warranty does not cover the following:

- Failures or malfunctions of the emission control systems caused by abuse, alteration, accident, misuse, the use of leaded gasoline.
- Replacement of expendable maintenance items unless they are original equipment defective in material or workmanship under normal use, and the first required replacement interval for the item has not been reached.

Expendable maintenance items include but not limited to spark plugs, filters, coolant, lubricants, gaskets, hoses, and belts.

- Replacements of parts and other services and adjustments for required maintenance.
- Any vehicle equipped with an odometer or hour meter where the reading is altered so that actual mileage cannot be readily determined.
- Repairs or replacements as a result of:
  - ✓ Accident
  - ✓ Misuse
  - ✓ Use of replacement parts or accessories not conforming to the original specifications which adversely affect performance
- Physical damage, corrosion, or defects caused by fire, explosions or similar causes beyond the control of the Distributor.
- Failures not caused by a defect in material or workmanship.

Use of the vehicle in any type of competitive racing or related events immediately and completely voids this and all other warranties.

## **LIMITED LIABILITY**

The liability of Ricky Power Sports, LLC under this Emission Control System Warranty is limited solely to the remedying of defects in material workmanship by an authorized dealer at its place of business during customary business hours. This warranty does not cover inconvenience or loss of use of the vehicle or transportation of the vehicle to/from the authorized dealer. Ricky Power Sports, LLC is not liable to any person for incidental, consequential or special damages of any description, whether arising out of express or implied warranty or any other contract, negligence or other tort or otherwise.

No express emission control system warranty is given by Ricky Power Sports, LLC except as specifically set forth herein. Any emission control system warranty implied by law, including any warranty of merchantability or fitness for a particular purpose is limited to the express emission control system warranty terms stated in this warranty.

The foregoing statements of warranty are exclusive and in lieu of all other remedies. All express warranties not stated in this warranty are disclaimed. Some states do not allow limitations on how long an implied warranty lasts, so the above limitations may not apply if it is inconsistent with the controlling state law.

No dealer is authorized to modify this Emission Control System Warranty. If you have any questions regarding your warranty rights and responsibilities, you should contact Ricky Power Sports, LLC(+1 844-250-2199).



**Ricky Power Sports, LLC.**

**2425 Camp. Avenue,**

**Carrollton, TX 75006**

**Toll Free: 844-250-2199**