



OWNER'S MANUAL

Magician 250 Bike

Minimum age requirement: 16



Always wear a helmet; It could save your Life!

This manual should be considered as a permanent part of the vehicle and should remain with the vehicle when resold or otherwise transferred to a new user or operator. The manual contains important safety information and instructions which should be read carefully before operating the vehicle.

INTRODUCTION

Congratulations on your purchase of the Ricky Power Sports LLC' Magician 250cc Bike.

Take time to understand how your motorcycle works before riding. Scheduled service is a must and it is important to follow the break-in guidelines and pre-ride instructions.

Make certain that you read the warranty coverage information provided and understand your responsibilities.

If you have any questions, comment or concerns contact Ricky Power Sports, LLC at 1-844-250-2199. All information, illustrations, photographs and specifications contained in this manual are based on the latest product information available at the time of publication. Due to improvements or other changes, there will be some discrepancies in this manual. We reserve the right to make product changes at any time, without notice and without incurring any obligation to make the same or similar changes to the vehicle previously built or sold.

SAFETY

The most important thing to remember is your safety and the safety of others. We have included procedures and labels to help you make safe informed decisions. This information is provided to make you aware of potential hazards that could hurt you and/or others. It is impossible to warn you of ALL potential hazards so you must use your own best judgement. The following are different kinds of safety information you will find in this manual:

Safety Labels - On your bike

Safety Messages - Warning, Caution and Danger

The meaning of Warning, Caution and Danger Safety Messages:



Death or serious injury CAN occur if proper instructions are not followed.

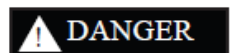

Death or serious injury WILL occur if proper instructions are not followed.

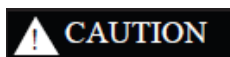

You CAN be hurt if proper instructions are not followed.

CONTENTS

WARRANTY	1
SAFETY INFORMATION	2
SAFETY LABELS	3
COMPONENTS LOCATIONS	4
INDICATORS	5
CONTROLS.....	6
FUEL VALVE	6
IGNITION SWITCH	6
START BUTTON AND ENGINE STOP SWITCH	6
HEADLIGHT DIMMER SWITCH, TURN SIGNAL SWITCH AND HORN.....	7
TRIP METER RESET	7
BEFORE RIDING	8
PRE-RIDE INSPECTION	9
LOADING GUIDELINES AND LOAD LIMITS	9
STARTING PROCEDURES.....	10
STARTING AND STOPPING THE ENGINE.....	11
SHIFTING GEARS.....	11
BRAKING.....	12
PARKING.....	12
SERVICING YOUR BIKE	13
MAINTENANCE SAFETY	13
MAINTENANCE SCHEDULE.....	14
MAINTENANCE SAFETY	15
MAINTENANCE SCHEDULE.....	16
MAINTENANCE RECORDS	17
TOOL KIT.....	17
SIDE COVER REMOVAL.....	18
FUEL AND ENGINE OIL.....	19
ENGINE OIL	19
AIR CLEANER	21
CRANKCASE BREATHER AND THROTTLE.....	22
CLUTCH SYSTEM	23
ENGINE IDLE SPEED	24
SPARK PLUG.....	24
SUSPENSION.....	25
BRAKES	26
BRAKE PADS WEAR.....	26
REAR BRAKE PEDAL FREE PLAY	27
TIRES	27
AIR PRESSURE	27
DRIVE CHAIN	29
BATTERY	31
APPEARANCE CARE.....	32
VEHICLE IDENTIFICATION	33
SPECIFICATIONS	34
WIRE DIAGRAM.....	35
RICKY POWER SPORTS, LLC. – EMISSION CONTROL SYSTEM WARRANTY	36

WARRANTY

Congratulations on your purchase of the Ricky Power Sports, LLC' Magician 250cc Dirt Bike.

It is warranted to be free of manufacturing defects in the material of workmanship for a period of 90 days from the date of purchase. During the warranty period Ricky Power Sports, LLC will at its option repair, provide replacement parts or replace your Ricky Power Sports, LLC' Magician 250cc Bike at no charge. This warranty does not cover normal wear items or damage caused by neglect or misuse of the product.

Engine Warranty - 90 days

Frame Warranty - 90 days

Warranty is void if:

Frame is bent or broken due to abuse.

Wheels are bent or broken.

Fender bent or broken due to abuse.

Any sign of impact, accident, jumping, spin-outs or roll over.

Ricky Power Sports, LLC is not liable for any damage claim or liability claim person or otherwise resulting from the operation of this product in any way.

Should you experience a problem or need to return your Ricky Power Sports, LLC' Magician 250cc bike for repair, please call the Ricky Power Sports, LLC customer service department TOLL FREE at 1-844-250-2199. You will be instructed how to proceed.

A COPY OF THE SALE RECEIPT IS REQUIRED.

SAFETY INFORMATION

This user's manual contains important safety and maintenance information. Read it carefully before riding. Failure to follow the warnings contained in this manual could result in INJURY or DEATH.

ALWAYS WEAR A HELMET

The operator and passenger (if any) of this vehicle should always wear a helmet approved by agencies such as the Department of Transportation (DOT), Safety Helmet Council of America (SHCA), or Snell Memorial Foundation (SNELL). Most accident fatalities are due to head injuries. The operator should also wear face shields or goggles, boots or closed-toe shoes, gloves and other appropriate protective clothing.

TAKE TIME TO LEARN AND PRACTICE

Take time to get to know this vehicle. The operator's ability to operate this bike safely is largely dependent upon the operator's ability to exercise proper judgment. The operator must be of sufficient age, understanding, mental capacity, and physical capability to safely operate this vehicle. This vehicle should only be operated after sufficient practice in a decongested area. Safe operation includes responsibility for the safety of a passenger (if any). We recommend that any inexperienced driver should take a certified course approved by the Motorcycle Safety Foundation (MSF).

RIDE DEFENSIVELY

A common accident happens when a car suddenly moves into your lane. Most motorcycle collisions happen when a car turns left in front of a motorcycle. Pay extra attention to other vehicles around you, never expect that they can see you.

MAKE YOURSELF VISIBLE

Make yourself more visible by wearing bright reflective clothing. Use your horn when it helps others see you and before turning use your turn signal.

RIDE WITHIN YOUR LIMITS

You should not ride beyond your abilities and never faster than the posted speed limit. NEVER OPERATE THIS VEHICLE WHILE UNDER THE INFLUENCE OF ALCOHOL, DRUGS OR MEDICATION OF ANY KIND. SUCH OPERATION COULD BE DANGEROUS TO YOURSELF AND/OR OTHERS.

KEEP YOUR VEHICLE IN A SAFE CONDITION

Proper maintenance will ensure a safe ride. Perform all recommended maintenance and inspect your vehicle before each ride. Never modify your vehicle in any way to make it unsafe.

SAFETY LABELS

The safety labels on your motorcycle provide you with important information do not remove them.

If a label becomes too difficult to read or comes off contact Ricky Power Sports, LLC for replacements.



⚠ WARNING

No one under the age of 16 should operate this vehicle without adult supervision.

⚠ WARNING

- Study the owners manual carefully
- Always wear a helmet, eye protection and protective riding gear.
- Do not drive while drinking alcohol or while on medication.

COMPONENTS LOCATIONS



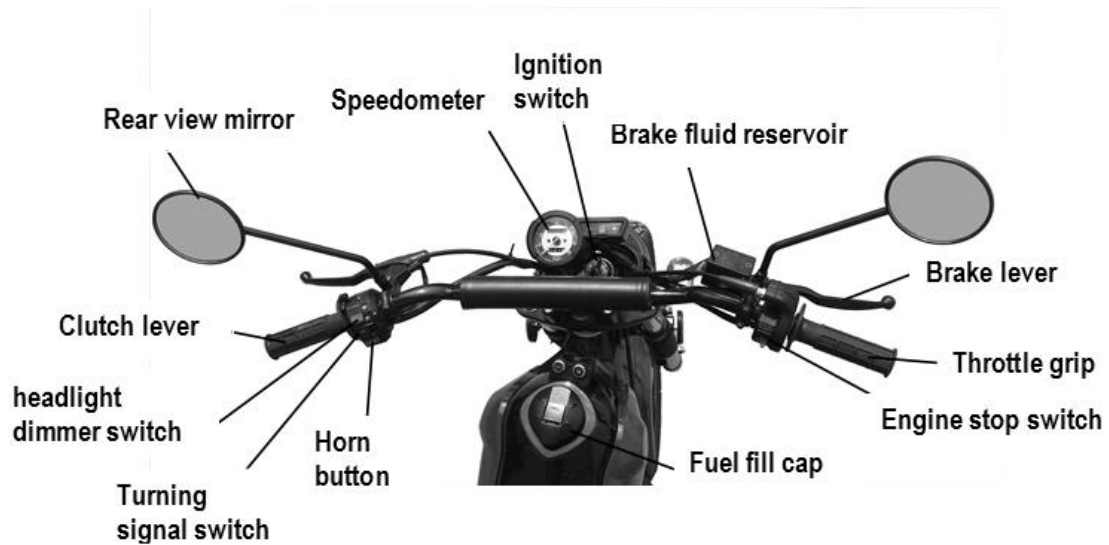

INDICATORS

The indicators on your motorcycle help make you aware of possible issues, refer to them often.

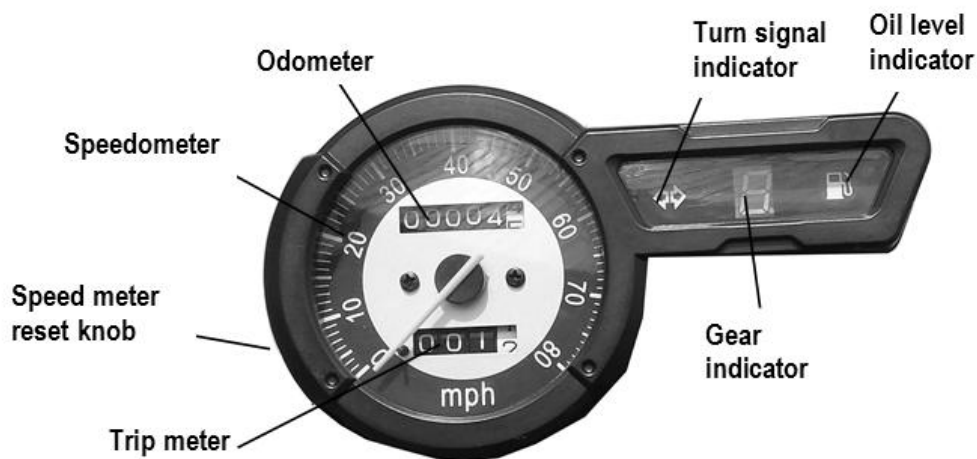

Speedometer - Shows the speed you are traveling miles per hour.

Odometer - Tracks the total miles driven.

Trip meter - Tracks the total miles driven on your trip.

Turn signal indicator - Flashes when left/right turn signal is on.

Gear indicator - Illuminates when transmission is in gear.

Oil level indicator - Flashes when oil is low.

Trip meter reset knob - Turn this knob to reset the trip meter.

CONTROLS

FUEL VALVE

Fuel valve - Used to control the flow of gasoline from the fuel tank to the carburetor.

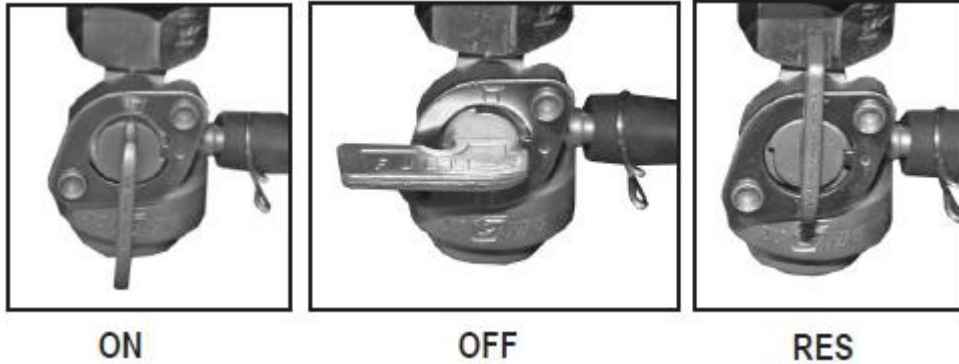

ON - gasoline can flow to the carburetor.

OFF - gasoline cannot flow to the carburetor.

RES - gasoline can flow to the carburetor when you have run out of gas in the gas tank. Make sure to refuel as soon as possible.

IGNITION SWITCH

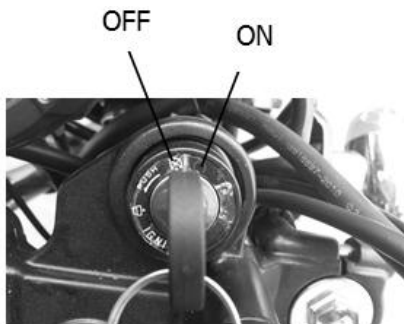



Ignition switch-Used for starting and stopping the engine.

ON-ALL electrical components are ON.

OFF-ALL electrical components are OFF.

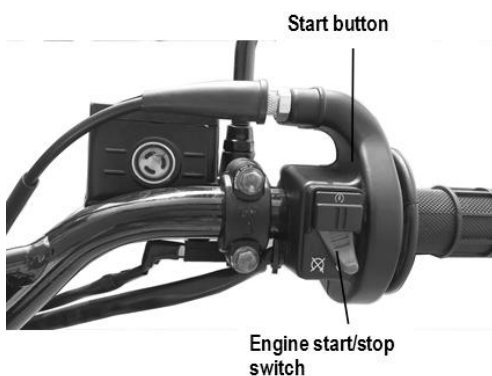
START BUTTON AND ENGINE STOP SWITCH



Start button  - Pushing the start button will start the engine. When button is pressed in the start motor will crank the engine, See starting procedures.

Engine stop switch- In case of an emergency and a quick stop is necessary turn switch to the "OFF" position. This switch must be in the "RUN" position in order to start the vehicle, and should remain in this position even while the engine is off. If you leave ignition switch on and engine stop switch off, the lights will stay on, causing the battery to lose life.

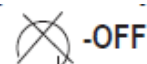
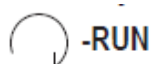

HEADLIGHT DIMMER SWITCH, TURN SIGNAL SWITCH AND HORN

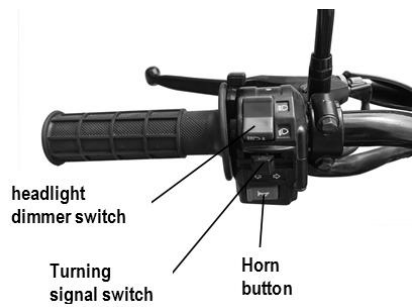

Headlight dimmer switch- This switch is used to change from "HI" to "LO" beam.



Turn signal switch- Use this switch to signal a lane change or turn. ← -Left → -Right

Horn- The horn is used to warn other motorist.



TRIP METER RESET

Trip meter reset knob- By turning the knob counter clockwise you can reset the trip meter to zero (0).



Trip meter reset Knob

BEFORE RIDING

Before your first ride on your new motorcycle we strongly recommend you:

- Read the owner's manual.
- Understand all safety labels.
- Know how to operate all controls.

Before you ride each time, make sure:

- You are in good physical and mental health.
- You are wearing protective gear (helmet, clothing, eye protection etc.) If you have a passenger, be sure also having protective wears for passenger.
- You do not have ANY alcohol or drugs in your system.

Protective Clothing

For your protection we urge you to ALWAYS wear protective clothing. The proper clothes can protect you from injury. Wear an approved motorcycle helmet, goggles, a good pair of gloves, strong boots that cover the ankle, long pants, and a long sleeve shirt every time you ride.

Helmets and Eye protection

A DOT approved motorcycle helmet is the most important part of your protective gear. A DOT approved motorcycle helmet can help prevent a serious head injury. Choose a helmet that fits snug. Motorcycle dealers can help in selecting a good quality helmet which fits properly.

WARNING

Not wearing a helmet greatly increases your chances of serious head injuries or death in the event of an accident. If you are riding with a passenger be sure they are also wearing a helmet and eye protection.

PRE-RIDE INSPECTION

Before each ride check the condition of your bike to make sure that it does not have mechanical problems. Your motorcycle should always be in good riding condition to ensure the safety of you, your passenger (if any) and others around you.

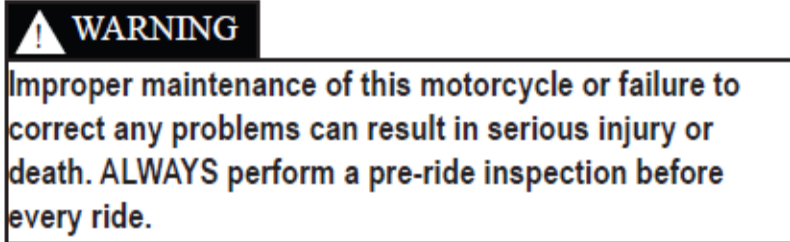

Be sure to check the following items before each ride:

BRAKES - Press on the brake pedal and hold in brake lever to ensure that the brakes are operating correctly.

THROTTLE - Rotate the throttle handle to ensure it moves smoothly.

LEAKS and LOOSE ENDS - Check all hoses for leaks and cables that may be loose.

LIGHTS - Be sure that your headlight, tail light, brake light and turn signals are working properly.

CHAIN - Check the condition. Adjust the slack (if any) and lubricate (if needed).

TIRES - Use an air pressure gauge to check the pressure. If needed add air. Look for excessive wear or damage.

If you are riding with a passenger or carrying cargo check:

LOAD LIMIT - Do not exceed the load limit.

CARGO - Secure all cargo.

REAR SUSPENSION - Adjust the suspension according to the weight of the load you are carrying.

Make certain that you keep with the Periodic maintenance (see periodic maintenance section).

LOADING GUIDELINES AND LOAD LIMITS

Your bike has been designed to carry you and one passenger. When a passenger is riding with you there will be a difference in the acceleration and braking.

Load Limits

Maximum weight capacity (including rider, passenger, accessories and cargo): 331 lbs (150kg)

Maximum cargo weight: 25lbs (10kg)

Loading guidelines

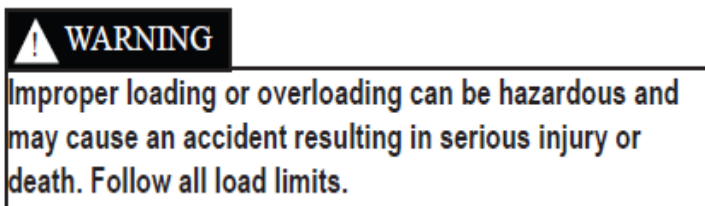

Improper loading of your bike may affect your stability. With the motorcycle properly loaded always ride at a reduced speed.

If you have questions about carrying cargo contact Ricky Power Sports LLC. for advice.

Check the following when carrying a passenger or cargo:

- Both tires are properly inflated.
- Rear suspension may need adjusting.
- Secure all cargo.
- Balance cargo weight
- Do not attach large or heavy items to the front of your bike.

Starting and Stopping the Engine

Always follow proper starting procedures.

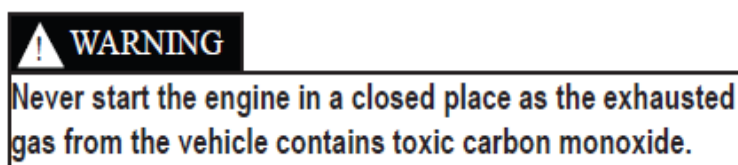

STARTING PROCEDURES

- Insert key into ignition, turn to "ON" position.
- Make sure the transmission is in the "NEUTRAL" position.
- Turn the engine stop switch to "RUN".
- Turn fuel valve to "ON".

If you are restarting a warm engine, follow procedure for High Air Temperature.

Normal Air Temperature : 10° -35° C (50° -95° F)

Starting and Stopping the Engine

High Air Temperature: 35°C (95°F) or above

DO NOT OPEN CHOKE

- 1) Slightly open throttle
- 2) Start engine

Low Air Temperature : 10° C (50° F) or below

- 1) Follow Normal Air Temperature procedures 1-2.
- 2) After RPM's pick up, open the choke to keep fast idle.
- 3) Keep warming the engine until it responds to the throttle when choke is closed.

NOTICE:

Extensive use of the choke can cause damage to the piston and cylinder wall.

Fast idling for more than 5 minutes at Normal Air Temperature can cause exhaust pipe discoloration.

Flooded Engine

The engine may be flooded with extra gasoline, if it does not start after several attempts. Try the following to clear a flooded engine:

- 1) Turn the engine stop switch to the "OFF" position.
- 2) Close the choke lever.
- 3) Open the throttle completely.
- 4) Push and hold in the start button for 5 seconds.
- 5) Wait 10 seconds and turn the engine stop switch to the "RUN" position.

Next, follow the High Air Temperature starting procedures.

STARTING AND STOPPING THE ENGINE

How to stop the engine

Normal Engine Stop

- Shift into neutral and turn the ignition switch "OFF".
- DO NOT leave the ignition switch "ON" while the engine stop switch is "OFF", this will allow the lights to stay "ON" causing the battery to lose life.

Emergency Engine Stop

If an emergency stop is necessary, use the engine stop switch. Simply press the emergency stop switch to "OFF".

SHIFTING GEARS

Your bike is equipped

with a cable-operated clutch.

It has five forward gears, one

down and four up.

Tips for learning how to shift for the inexperienced rider:

- Shift while moving a straight line.
- Let loose on the throttle and pull in clutch lever completely before shifting (improper shifting may cause damage to the engine).
- Recognize the engaging point when you release the clutch lever.

Tips for learning how to shift for the inexperienced rider (continued):

- Reduce the throttle or shift to a higher gear before engine RPM's get too high.
- Shift to a lower gear before the engine RPM's get too low.
- When the engine RPM's are too high do not downshift to slow your bike, this could cause damage.
- Do not coast or tow your motorcycle for a long period of time while the engine is off.
- If your speed drops below 9mph (15km/h) pull in clutch lever and shift down to 1st gear or stalling can occur.

Recommended shift point

To get the best fuel economy possible ride in the highest gear that allows the engine to run and accelerate the smoothest.

Shifting up from:

1st to 2nd - 12mph (20km/h)

2nd to 3rd - 19mph (30km/h)

3rd to 4th - 25mph (40km/h)

4th to 5th - 31mph (50km/h)

Shifting down from:

5th to 4th - 22mph (35km/h)

4th to 3rd - 16mph (25km/h)

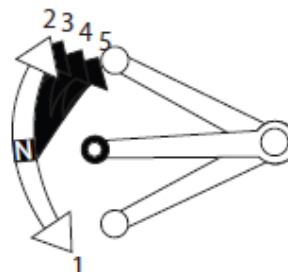

BRAKING

Your bike is equipped with a hand operated front hydraulic disc brake and a foot operated rear hydraulic disc brake. Your front brake provides 70% of your braking power. By using both front and rear brakes you will achieve faster, more stable and effective braking.

To slow down or stop your bike apply front and rear brakes while down shifting. Slowly increase brake as you feel your speed reduce. In order to prevent stalling, pull in clutch lever before stopping completely.

If you apply your brakes too abruptly you may lock the wheels, slide and loose control of your bike. If this should happen, release the brakes and steer straight until you have completely regained control.

Before making a turn, reduce your speed. Try not to brake or close the throttle too quickly while turning or you may loose control of your bike.

When traveling down a steep grade, reduce your speed by down shifting rather than braking. Applying your brakes for a long period of time can reduce their effectiveness.

You should never ride with your foot resting on the brake pedal or your hand on the brake lever. This may cause your brakes to overheat and indicate false braking to other motorist's.

PARKING

Try, when possible, to park on level ground. If you have no paved surface to park on, make sure the ground is firm. If it is necessary for you to park on a hill, position your rear wheel against the curb at an angle and leave the transmission in gear.

While parked, use the side stand for support.

- Use your foot to guide the side stand down.
- Put something solid under the side stand if you must park on a soft surface.

Theft-Prevention tips

- You should park your bike in a garage if possible, otherwise make certain to park in a well lit area.
- Never leave the ignition key with the bike.
- You should invest in a good quality anti-theft device that will secure your bike to a stationary object.

- Keep the owner's manual, registration and insurance with the bike to help authorities find you if it has been stolen and recovered.

SERVICING YOUR BIKE

This section is provided to help you keep your bike in good running condition.

The following table provides you with the three types of inspections recommended for your bike.

Type of inspection/ service	When to perform?	Who performs?
Pre-ride inspection	Before every ride	You
Maintenance schedule	Interval on schedule	Service Center

It is essential to your safety that you keep your bike well maintained. A properly maintained bike will help protect your investment, avoid break-downs and assure having maximum performance. The maintenance of your motorcycle is YOUR responsibility.

⚠ WARNING
Follow all maintenance and inspection recommendations. Improper maintenance can cause an accident resulting in injury or death.

In the event of an accident have a service center inspect ALL parts even if they appear to be undamaged.

MAINTENANCE SAFETY

This section will instruct you on how to perform some important routine maintenance. You can perform many of these tasks with the tools provided with the motorcycle. The more difficult tasks, such as wheel removal, should be performed by a professional technician. If you do not feel capable of performing any one task do not hesitate to contact your local service center for help.

⚠ WARNING
Failing to follow these maintenance instructions can result in serious injury or death.

Important Safety Precautions

- Always turn the engine off before performing any maintenance or repairs.
- Let the engine cool before touching any related parts.
- Do not touch any moving parts while engine is running.
- Make sure you have the tools and skills required before performing any maintenance repairs.
- Use the side stand or maintenance stand to prevent the bike from falling over.
- Keep cigarettes, sparks, and flames away from all fuel-related parts. Use a non-flammable solvent when cleaning parts.

Keep in mind that your local service center is equipped with the proper tools and knowledge to help service your bike. If necessary please contact them to ensure greater quality and reliability.

Including the regular maintenance and pre-ride inspection, perform the periodic checks once a month and once a week if you ride frequently.

Check the odometer and perform any scheduled maintenance necessary.

Tires –

- Check the air pressure and add air if needed.
- Check for any excessive wear on the tread.
- Check for any damage that may have occurred.
- Check the rims and spokes for any possible damage.

Fluids –

- Check the level of engine oil.
- Check the level of the brake fluid.
- Add the correct fluids if necessary.

Lights –

- Check the headlight, brake light, tail light and turn signals. Make certain they all work properly.

Free play –

- Check the clutch lever, rear brake pedal and throttle grip.

Drive Chain –

- Check the condition, adjust the slack and lubricate if necessary.

Fuses –

- Always have spare fuses.

Nut and bolts –

- Check all nuts and bolts, tighten if needed.

MAINTENANCE SCHEDULE

This portion of the manual will tell you how often to perform maintenance. The maintenance schedule is based on average riding conditions. If you ride more frequently than usual and in dusty or wet weather be sure to maintain your bike more often. We recommend that you have your local service center perform extensive maintenance and repairs unless you have advanced mechanical skills.

Every maintenance item requires some mechanical knowledge. Some parts require more technical information and tools than others.

* Unless you have proper tools and service information, have your local service center perform these tasks.

** For safety reason, ONLY your local service center should perform these tasks.

NOTES:

1. Repeat the frequency interval at higher odometer readings.
2. Service more frequently if you are riding in dusty or wet areas.
3. Service more frequently if you are riding at full throttle or in rain.
4. Replace every 2 years or at indicated odometer reading, whichever comes first.

MAINTENANCE SAFETY

I - Inspect, clean, adjust, lubricate or replace if necessary

C - Clean A - Adjust L - Lubricate R – Replace

Frequency		Emission Related Items										
		X 1,000mi	0.6	4	8	12	16	20	24			
Item	Note	X 1,000km	1.0	6.4	12.8	19.2	25.6	32	38.4			
*					I		I					I
*					I		I					I
*					I		I					I
	2					R						R
	3			C	C	C	C	C	C	C	C	C
				I	R	I	R	I	R	I	R	I
*			I	I	I	I	I	I	I	I	I	I
			R	R	R	R	R	R	R	R	R	R
**					C		C			C		C
*			I	I	I	I	I	I	I	I	I	I
*	5					I						I

MAINTENANCE SCHEDULE

I - Inspect, clean, adjust, lubricate or replace if necessary

C - Clean A - Adjust L - Lubricate R – Replace

Non - Emission Related Items

Item	Frequency	X 1,000mi	0.6	4	8	12	16	20	24	
		X 1,000km	1.0	6.4	12.8	19.2	25.6	32	38.4	
Drive chain	Note 4	1, L Every 500 miles (800km)								
Brake fluid				I	I	R	I	I	R	
Brake shoe/pad wear				I	I	I	I	I	I	
Brake system			I		I		I		I	
* Brake light switch					I		I		I	
* Headlight aim					I		I		I	
Clutch system			I		I		I		I	
Side stand					I		I		I	
* Suspension					I		I		I	
* Nuts, bolts, fasteners			I		I		I		I	
** Wheels/tires			I		I		I		I	
** Steering head bearings			I		I		I		I	

MAINTENANCE RECORDS

To ensure proper maintenance keep record. If the motorcycle is sold be sure to include the maintenance records. All scheduled maintenance is considered normal operator cost if a service center performs these tasks you will be charged. Please use the tables below to keep track of all maintenance performed.

Miles (km)	Odometer	Date	Performed by:	Notes
600 (1,000)				
4,000 (6,400)				
8,000 (12,000)				
12,000 (19,200)				
16,000 (25,600)				
20,000 (32,000)				

Miles (km)	Odometer	Date	Performed by:	Notes
24,000(38,400)				
28,000(44,800)				
32,000(51,200)				
36,000(57,600)				
40,000(64,000)				
44,000(70,400)				
48,000(76,800)				
52,000(83,200)				
56,000(89,600)				
60,000(96,000)				

TOOL KIT

Your tools are in the tool kit bag. These tools may come in handy during minor roadside repairs and adjustments.

Tools in tool kit:

- Tool bag



SIDE COVER REMOVAL

Left Side Cover

In order to clean and maintain the air cleaner and fuses you must remove the left side cover.

Removal

1. Remove bolt.
2. Remove cover.

Installation

1. Align prongs
2. Reverse removal steps.

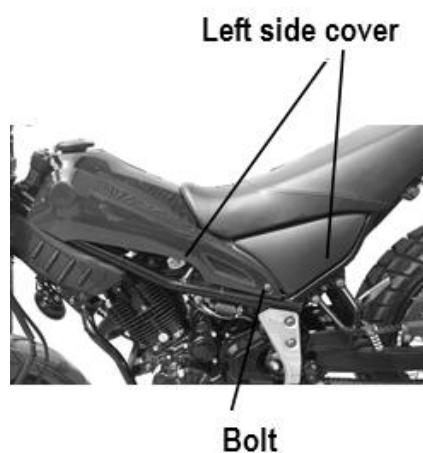

Right Side Cover

In order to clean and maintain the battery you must remove the left side cover.

Removal

1. Remove bolt.
2. Remove cover.

Installation

1. Align prongs.
2. Reverse removal steps.

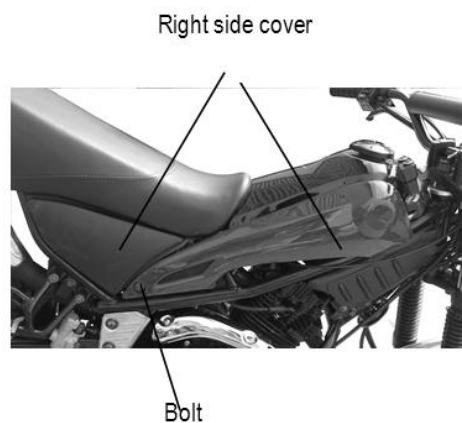

Fuel

Fuel Recommendation

Type - Unleaded

Octane number - 90 or above

Unleaded fuel produces fewer engine deposits and will extend the life of the exhaust system components. We suggest you use regular unleaded fuel. Be sure to only use an

octane number of 90 or higher. Using a lower octane gasoline can cause severe damage to the engine. Never use stale or contaminated gasoline or an oil/gasoline mixture.

Fuel Capacity

Fuel tank capacity, including reserve - 7L

Reserve capacity – 1L

After using the reserve tank you should refill the gas tank immediately. Then turn the fuel valve to the "ON" position so you do not run out of fuel in the reserve tank.

FUEL AND ENGINE OIL

Refueling

1. Insert ignition key in the fuel fill cap and turn clockwise.
2. Open cap.
3. Add fuel to the bottom of the filler neck. Do not overfill.



! WARNING
Gasoline is extremely flammable and explosive. You can be burned or seriously injured.

4. After refueling, push cap into the filler neck until it snaps and locks.
5. Turn the fuel valve back to the "ON" position (if it was in the "RESERVE" position).

By using, checking, adding and changing the recommended engine oil you can prolong the life of your engine. Changing your engine oil helps get rid of dirt or debris that can damage the engine. Always be sure to keep the right amount of oil in the engine or serious damage can occur.

If you are driving in dusty areas you should change the oil more frequently.

ENGINE OIL

Recommended Oil

The lubricating oil is an important factor affecting the performance and service life of the engine. Please refer to the chart for the correct grade of engine oil based on the environmental conditions in your area. Do not use any other type of oil other than what is recommended in the chart.

DO NOT MIX OIL WITH THE GASOLINE.

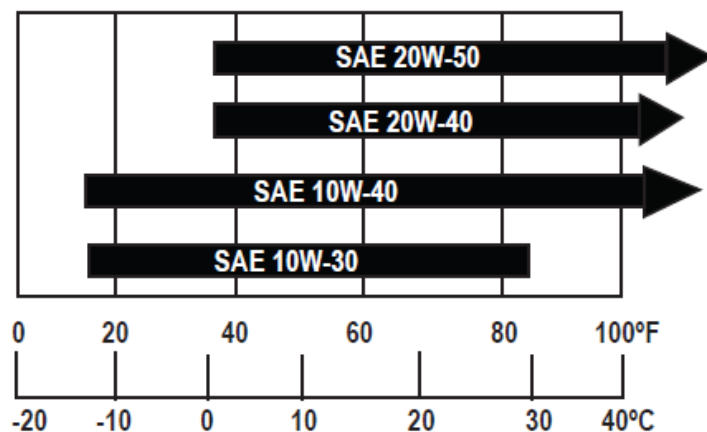

- Use the recommended oil, the oil does not need additives.
- Do not use graphite oil or oil with molybdenum additives.
- Do not use castor based racing oil, vegetable oil or non-detergent oil.

Lubricating oils of different viscosity shall be employed in different regions and at different temperatures.

Checking and Adding Oil

Upper level mark

Lower level mark

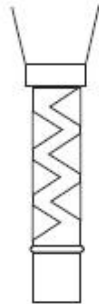

Oil fill plug/dipstick



Checking and Adding Oil

1. Park your motorcycle on level ground and use the side stand for support.
2. Start the engine and let it run for 3-5 minutes.
3. Turn the engine off and wait for at least 3 minutes.
4. Remove the oil fill plug/dipstick and wipe clean.
5. Hold the motorcycle in an upright position.
6. Insert the dipstick in the oil fill until it rests on the metal, do not screw it in.
7. Remove the dipstick and check the oil level.
 - If the oil is at or near the upper level mark there is no need to add oil.
 - If the oil is at or near the lower level mark, add the recommended oil until it reaches the upper level mark and do not overfill.
8. Screw in the oil fill plug/dipstick.
9. Check for any leaks.

Changing Engine Oil

This procedure will require some mechanical skill and special tools such as a torque wrench. If you are not capable of performing this procedure contact your local service center.

Draining Engine Oil

1. Park your bike on level ground and use the side stand for support.
2. Start the engine and let it run for 3-5 minutes.
3. Turn the engine off and wait for at least 3 minutes.
4. Remove the oil fill plug/dipstick, engine oil drain bolt and washer, to drain the oil into an oil pan.

NOTICE: Improper disposal of oil can be hazardous to the environment.

5. Dispose of oil in an appropriate manner.

6. Make sure the sealing washer is in good condition, if not replace it. You should replace every other time you change the oil.



Engine drain bolt

Adding Engine Oil

7. Install the engine drain bolt and torque to 18lbs.ft (25Nm).
8. Fill crankcase with recommended oil - 1.6 US qt.
9. Reinstall the oil fill plug/dipstick
10. Start engine and let idle for 3-5 minutes.
11. Turn engine off and let stand for 2-3 minutes.
12. Hold the motorcycle in an upright position, and check the oil level.
13. Make sure there are no leaks.

AIR CLEANER

Be sure to clean the air cleaner more frequently if you are riding in dusty or wet areas. Your local service center can help you determine the correct service interval for your riding conditions.

Use only the air cleaner specified for your motorcycle or one of equivalent quality.

NOTICE: Using the correct air cleaner can prevent engine wear, damage, repairs, spark plug fouling and poor gas mileage. If you use the incorrect air cleaner you may cause severe engine damage.

NOTICE: Improper air cleaner maintenance can cause early engine wear or poor performance.

Replacing Air Cleaner

1. You will need to remove the seat in order to access the bolt that needs to be removed in order to take the side cover off. Remove seat by inserting ignition key into key slot on side cover. Turn key clockwise and seat will unlatch.
2. Remove bolt and bolt A.

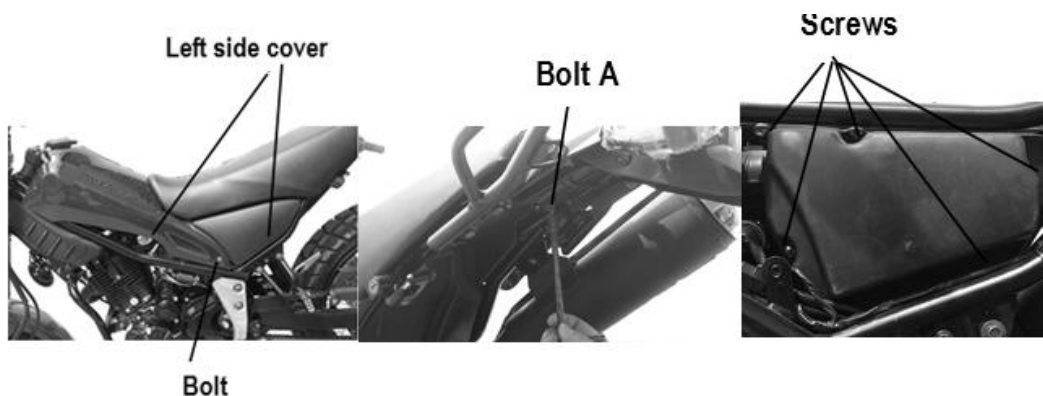

3. Remove left side cover and unscrew screws holding air cleaner cover on.
4. Discard air cleaner.
5. Install new air cleaner.
6. Replace air cleaner cover using screws.
7. Replace left side cover using bolt to secure.

CRANKCASE BREATHER AND THROTTLE

Crankcase Breather

You should service the crankcase breather more often if you are riding at full throttle or in rain. Be sure to service, if there are deposits in the transparent section of the drain tube.

Draining

1. Place a drain, oil pan under the crankcase breather tube plug.
2. Remove the plug so that the tube drains into the pan.
3. Re-install the crankcase breather tube plug.

THROTTLE

Inspection

Check the free play at the throttle grip.

Free play: 1/16-1/4 inch (2-6mm). If needed, adjust to specified free play.

Adjustment

1. Turn lock nut.
2. After the adjustment has been made, check the full rotation of throttle grip from all steering positions.



Nut

Throttle Inspection

1. Make sure that all nuts and bolts are securely fastened and the throttle assembly is positioned correctly.
2. Check the full rotation of the throttle grip from all steering positions.

CLUTCH SYSTEM

The proper free play adjustment of the clutch allows for a gradual, smooth engagement when shifting gears.

Early wear can occur if you do not properly adjust the free play.

Clutch Free Play

Left handlebar inspection

Check free play, if needed adjust to specified adjustment.



Upper Adjustment

Always adjust using the upper clutch cable adjuster before using the lower adjustment.

1. Loosen upper lock nut.
2. Rotate the upper clutch cable adjuster until the proper free play has been accomplished.
3. Tighten the upper lock nut and check that the free play is correct.

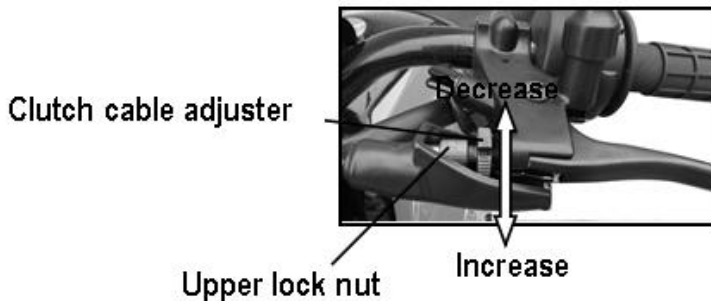

If the upper clutch cable adjuster has reached its limit or you cannot obtain the correct free play, you may also use the lower clutch cable adjuster.

1. Loosen the upper lock nut and rotate the upper clutch cable adjuster in to maximum free play.
2. Tighten the upper lock nut.

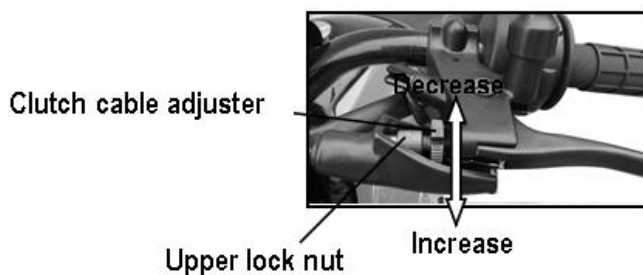

3. Loosen lower lock nut.
4. Rotate lower adjusting nut until the proper free play has been accomplished.
5. Tighten lower lock nut and check adjustment.
6. Start engine, hold in clutch lever and shift into gear. Make sure the engine does not stall and the motorcycle does not move. Slowly release the clutch lever and open the throttle, your motorcycle should accelerate gradually and move smoothly.

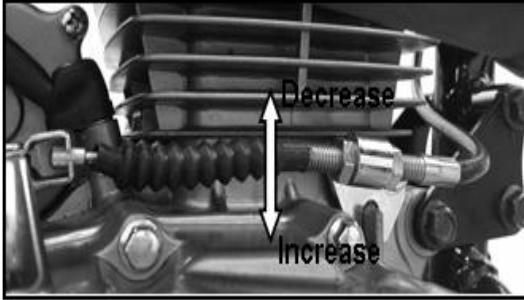

If you cannot accomplish the correct free play using both adjustments, contact your local service center.

ENGINE IDLE SPEED

For the best servicing you should visit your local service center.

Adjusting the idle speed will not cure all problems in the engine fuel delivery system.

Idle Speed Adjustment

1. If the engine is cold, start it and run for 10 minutes of stop and go riding. Turn the engine off.
2. Park the bike on a level surface using the side stand.
3. Connect tachometer to the engine.
4. Shift into neutral and start engine.
5. Adjust the idle speed with throttle stop screw.

Idle Speed (in neutral): 1,500 rpm \pm 150rpm.

SPARK PLUG

Spark Plug Recommendation

Do not use any spark plug other than the one recommended in the heat recommended.

NOTICE: If you use a spark plug in the improper heat range you can cause engine damage.

Spark Plug Replacement:

1. Clean any/all dirt around the spark plug base.
2. Disconnect the spark plug caps and make certain you do not damage the wires.
3. Remove the spark plug using the spark plug wrench provided in the tool kit.
4. Inspect the electrodes on the spark plug for corrosion and deposits, if it has great corrosion replace the plug.

5. Using a wire-type feeler, check the gap on every new spark plug. If an adjustment is needed, bend the electrode carefully, the gap should be: 0.024 - 0.031 inch (0.60 - 0.80mm).
6. Thread spark plug in by hand so there is no cross-threading.
7. Tighten, old but still good, spark plug: 1/8 - 1/4 turn after it seat. Tighten new spark plug: 1/2 turns after seated.
8. Reinstall the spark plug caps.

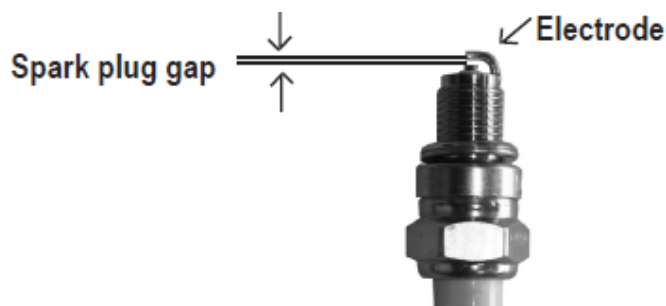

NOTICE: Incorrect tightening of the spark plug can cause severe damage to the engine. Too loose can damage piston, too tight can damage the threads.

SUSPENSION

The front and rear suspension systems consist of springs and hydraulic damping devices. The rear suspension system has a spring pre-load which adjusts the force needed to begin compression of the spring. Traction and comfort are acquired by the oil damper system. It hydraulically controls the compression and rebound of the suspension.

Whenever you change the load on your motorcycle (add passenger or cargo), or when riding conditions change, be sure to adjust the rear suspension pre-load.

If you set the spring pre-load to a lower setting would accomplish a softer ride. This setting should be used with a light load and smooth roads. For a more firm ride set the spring pre-load to a higher setting, used for heavy loads, rough roads and a more challenging ride.

Rear Suspension Adjustment

Adjustment to the spring pre-load on the rear suspension should be done for the weight of a rider and passenger (if any) and different riding conditions.

The adjustments in this manual are limited. Do not disassemble or service the dampers, have your local service center perform these tasks.

BRAKES

Your bike uses hydraulic disc brakes(front and rear).

Hydraulic Liquid Front Brake

The brake fluid will drop as the or if there is a leak. To ensure there are no leaks, often check the brake system. You should also check the brake pads for wear and the brake fluid level. If you feel abnormal free play in the brake lever, check for wear on the brake pads. If you discover the brake pads to be worn you should replace them immediately. If the pads are still in good condition there may be air in the brake system. You will need to bleed the brakes, visit your local service center for help.

Brake Fluid Recommendation

We recommend that you use DOT3 brake fluid or any brake fluid of the same quality. Always use a fresh, new container of brake fluid, never use an opened container that may be contaminated.

Brake Fluid	DOT4
-------------	------



Brake Fluid Level Inspection

1. Park your bike on level ground in an upright position.
2. Check the fluid level. It should be above the lower mark, if not, check for wear on the brakes. If the pads are worn, replace immediately. Have your local service center do this.

Other Inspections

- Make sure there are no leaks in the fluid lines.
- Check for loose fittings or damage to the fluid lines.

NOTICE: Brake fluid can damage painted surfaces and plastic, handle with care. Clean any spills immediately. In case of contact with skin, wash thoroughly. Contact with eyes, wash thoroughly and see a doctor immediately.

BRAKE PADS WEAR

Brake pad wear depends on how much you use the brakes, the type of riding and road conditions. Normally brake pads tend to wear quicker on wet and dirty roads. Be sure to check the pads for wear during each maintenance interval.

You can inspect the wear on pad by using the wear indicator mark. If the pads are worn, replace immediately. Have your local service center do this.



REAR BRAKE PEDAL FREE PLAY

Brake Pedal Height Adjustment

The height of the brake pedal can be adjusted by using the stopper bolt.

1. Loosen lock nut and turn stopper bolts to adjust.
2. Tighten lock nut.



Inspection

1. Park your bike on the side stand for support.
2. Depress the brake pedal until it starts to engage to check the free play: 0.78-1.2 inch (20-30mm). If needed, adjust to specified range.

TIRES

The tires on your motorcycle should be the proper type and size. They should be in good condition and properly inflated for the load that you are carrying.

! WARNING

Operating this motorcycle with improper tires, or even improper tire air pressure could be hazardous. If you use improper tires or improper tire air pressure, you may lose control of the motorcycle. Always use the size and type tires specified. Always maintain proper tire air pressure as described in this section.

AIR PRESSURE

Check the air pressure in both tires before riding. Improper air pressure would effect handling, steering response, traction, tire life and rider comfort. We suggest you visually check the tire pressure before each ride and check the pressure each month by using an air pressure gauge. Be sure that the tires are inflated to the pressures shown below. Tire pressure should only be measured or adjusted when the tires are cold.

Front Tire Pressure	32psi (225kpa)
Rear Tire Pressure	40psi (280kpa)

Inspection

Always look for the following when checking tire pressure:

- Bumps or bulges on the tire, if there are any replace the tire.
- Cuts or cracks, replace tire if any fabric is visible.
- Any foreign objects such as nails embedded in the tire.
- Excessive wear.

Pull to the side of the road if you drive over a pothole or any hard objects to inspect the tire for possible damage.

You should replace the tires if the thread wear reaches the following limits:

Front (from center of tread)	0.06 inch (1.5mm)
Rear (from center of tread)	0.08 inch (2.0mm)

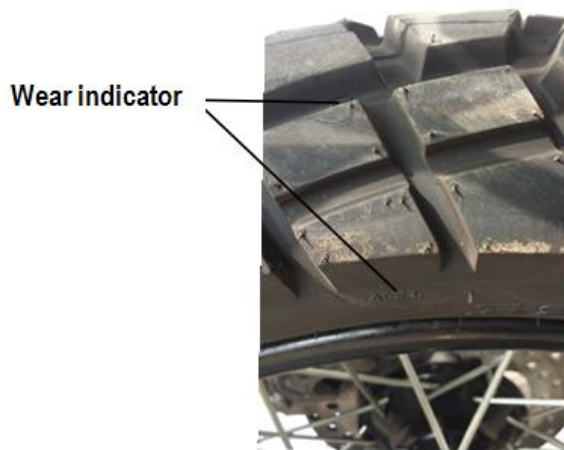

Replace tire immediately if the wear indicators are not visible.

Tires and Tube Repair

If your tire is punctured or damaged, please replace the tire, do not repair. A repaired tube may fail while riding, and is not as reliable as a new one. A temporary repair can be made in an emergency situation, but will not perform at its best. Ride at slow speeds and do not carry a passenger with a repaired tire. Have the tire and tube replaced as soon as possible.

If you replace only the tube and not the tire do not exceed 50mph for the first 24hrs and 80mph anytime after.

Tire Replacement

When tire replacement is needed always replace them with the same size, load range and speed rating.

⚠ WARNING

Only use the tire size and type recommended.
Using improper tires can affect stability and handling
which may cause an accident resulting in injury or death.

Recommended Tire Size:

Front - 100/80-19

Rear - 120/90-16

When replacing a tire:

- Have the wheel balanced after installation.
- If possible, have tire replaced by your local service center.
- Replace the tube.

Safety Reminders

- Do not replace tire with a Radial tire. Using a different type of tire may affect stability and handling.
- Do not replace with car tires. The tire may forcefully separate from the rim during installing causing serious injury or death.

DRIVE CHAIN

There is a riveted master link on the chain which connects the counter-shaft to the rear wheel sprockets. To keep moisture and dirt out the O-ring chain uses rubber rings between the side plates of the pin and roller links to seal in the lubricating grease. Proper lubrication and adjustment will help extend the life of the chain. You should always perform the pre-ride inspection to check the adjustment and lubrication before riding. If you are riding in dusty or muddy conditions remember to maintain and service the chain more often than usual.

Before any servicing to the chain occurs be sure the engine is off and in neutral.

You do not need to remove the chain to perform service in the maintenance schedule

Inspection

1. Check the slack of the lower drive chain right between the two sprockets.
2. The slack should remain consistent along the entire chain, if not, check to make sure there are no kinks or binds. You can sometimes eliminate kinks or binds by lubricating the chain.

3. Inspect chain for:

- Damaged rollers
- Kinks or binds
- Dry or rusty links
- Improper adjustment
- Excessive wear
- Damaged or missing o-rings.

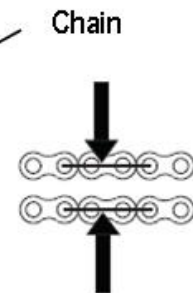

The chain should be replaced if there is damage to the rollers, or if there are loose pins. Lubricate any kinks or binds to work them out. If the chain appears too dry or rusty, lubricate.

4. Check both the front and rear sprocket teeth for excessive wear or damage. If needed replace the sprocket.

NOTICE : The use of a new chain with a worn sprocket will cause quick wear to the chain.

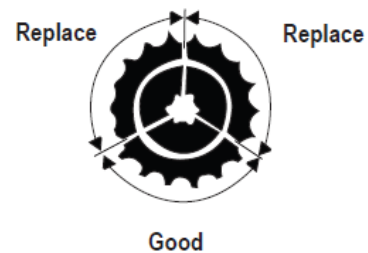

Adjustment

Every 500 miles you should check and adjust (if needed) the slack of the drive chain. If you are riding at high speeds the chain may need adjusting more often.

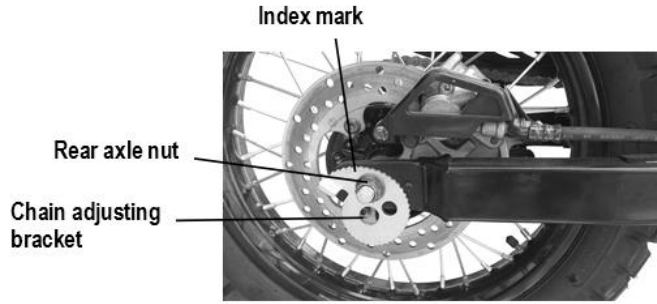

1. Place the bike on level ground using the side stand. Make sure the transmission is in neutral and the ignition switch if in the "OFF" position.
2. Loosen the rear axle nut.
3. Turn the chain adjusting brackets on the left and right sides to adjust the tension of the chain and to align the marking of the chain adjuster with the engraved lines in the similar position on both sides.
4. Tighten rear axle nut by a torque of 88Nm (65 ft.lb.). If you do not have a torque wrench available make sure to have your local service center perform this task.
5. Repetitively check the tension of the chain.

If they do not match up, turn the left or right adjusting nut until the marks correspond and recheck the chain slack.

Lubrication

Lubricate the chain every 500 miles and more often if it appears to be dry. Only use SAE 90 gear oil for lubrication, other chain lubricants may contain solvents that can damage the rubber o-rings.

Removal, Cleaning and Replacement

Your motorcycle has a riveted master link and should only be removed or replaced by your local service center.

Do not use a steam cleaner, high pressure washer or certain solvents. These products can damage the o-rings.

1. Use a dry cloth to clean the side surface of the chain. Use a high flash point solvent, not gasoline. Do not use a solvent or brush to clean the o-rings.
2. Check to make sure the chain is not damaged or worn. If needed, replace the chain.

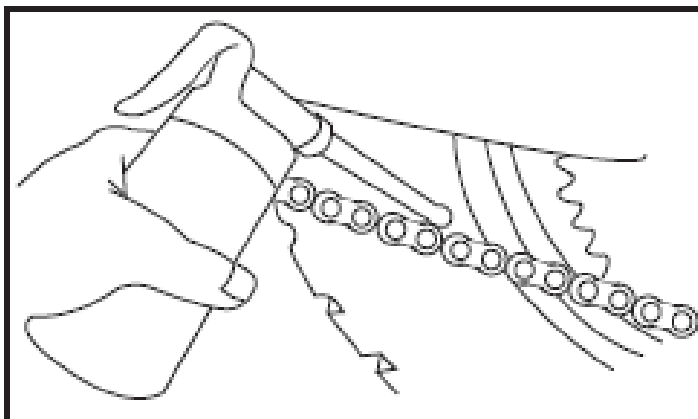

BATTERY

Your bike is equipped with battery. Please check the electrolyte level or add distilled water when they are shortage.

NOTICE: If you remove the cap strip you can permanently damage the battery.

Any electrical accessory will use currents from the battery. If you have electrical accessories on your motorcycle and you ride often, be sure to charge the battery frequently.

You should remove the battery or disconnect the battery cables if you do not plan to ride for two weeks or more.

WARNING

**Immediately wash hands after handling battery.
Battery and related components contain lead and lead compounds.**

Battery Storage

We recommend that you remove the battery from your bike if you are planning to store it for a long period of time. In order to maintain the life of the battery while storing you should slow trickle charge the battery every 30 days. If you do not remove the battery you should disconnect the battery wires (negative wire first).

Battery

WARNING

- To avoid possibility of explosion, always connect battery cable in order specified: Negative first, Positive last. An exploding battery can cause serious injury or death.
- Batteries contain sulfuric acid.
- Always shield eyes with protective eye wear when working around battery acid.
- Battery acid is poisonous and can cause severe burns.
- DO NOT smoke around batteries and keep away from open flames.

The battery can be found in the battery box under the right side cover below the driver seat.

1. Remove the right side cover.
2. Remove the rubber strap holding the battery in place.
3. Disconnect the Negative terminal lead first, then the Positive terminal lead.



4. Remove the battery from the battery box.
5. Unless you have been riding on a regular basis, charge the battery.
6. Store the battery in an easily accessible, neutral climate location (off of the floor and out of reach of children).
7. Clean battery box before storing.
8. Use a slow trickle charger every 30 days to maintain life of the battery.

Charging the Battery

Charging the battery incorrectly may cause damage. Always read the instructions that came with the battery charger and follow all directions on the battery.

For home charging we suggest you use a trickle charger. A trickle charger can be left connected for a long period of time without causing damage to the battery. Do not leave the battery connected to the charger longer than the recommended amount of time.

Do not use an automotive battery charger as this can cause permanent damage to your battery.

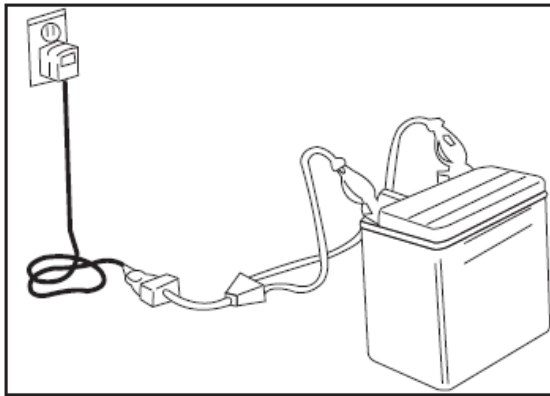

APPEARANCE CARE

You should always clean and polish your bike on a regular basis to keep it looking newer longer.

General Recommendations

- You may use the following to clean your bike:
 - a mild, neutral detergent and water
 - a mild spray and cleaner/polisher
 - a mild cleaner/de greaser
- Do not use products that contain chemical solvents or harsh detergents.
- Before cleaning, make sure the engine is cool.
- Wash your bike in a shady area. Direct sunlight can cause water spots and fading.
- Do not use a high pressure washer to clean, we suggest you use a garden hose.

NOTICE: High pressure washers can cause damage to certain parts of your bike.

- When you are finished cleaning your bike, always check for wear or leaks.

VEHICLE IDENTIFICATION

Serial Numbers

The frame (VIN) and engine serial numbers will be required when you register your bike. You may also need this information when ordering parts, make sure to keep these numbers in a safe spot.

Frame number (VIN- Vehicle Identification Number) can be found stamped in the steering stem.

Frame serial number



Engine number can be found stamped into the right side of the crankcase.

Engine serial number



SPECIFICATIONS

Overall length	1980mm
Overall width	840mm
Overall height	1170mm
Wheel base	1370mm
Curb mass	118kg
Fuel recommendation	Octane 90 or above
Fuel tank capacity	7L
Engine oil recommendation	API service classification SF SAE 15W-40
Passenger	One driver and one passenger
Displacement	229cc
Bore and stroke	67×65mm
Top speed	95km/h
Compression ratio	9.0:1
Spark plug (standard)	TORCH D8RTC
Spark plug gap	0.6 ~ 0.8mm
Idle speed	1500±150rpm
Valve lash	0.05mm
Front tire size	100/80-19
Rear tire size	120/90-16
Front tire pressure COLD	32psi(225kpa)
Rear tire pressure COLD	40psi(280kpa)
Battery	12V-7AH
Headlight	12V35W/5W
Brake/Tail light	12V5W/21W
Turn signal light	12V10W
Neutral indicator	12V3W
Turn signal indicator	12V3W
Hight beam indicator	12V3W
Main Fuse	10A
Oil drain bolt torque	18ft.lbs(25Nm)
Front wheel axle torque	45ft.lbs(61Nm)
Front wheel pinch bolts torque	16ft.lbs(22Nm)
Rear wheel axle nut torque	65ft.lbs(88Nm)

WIRE DIAGRAM

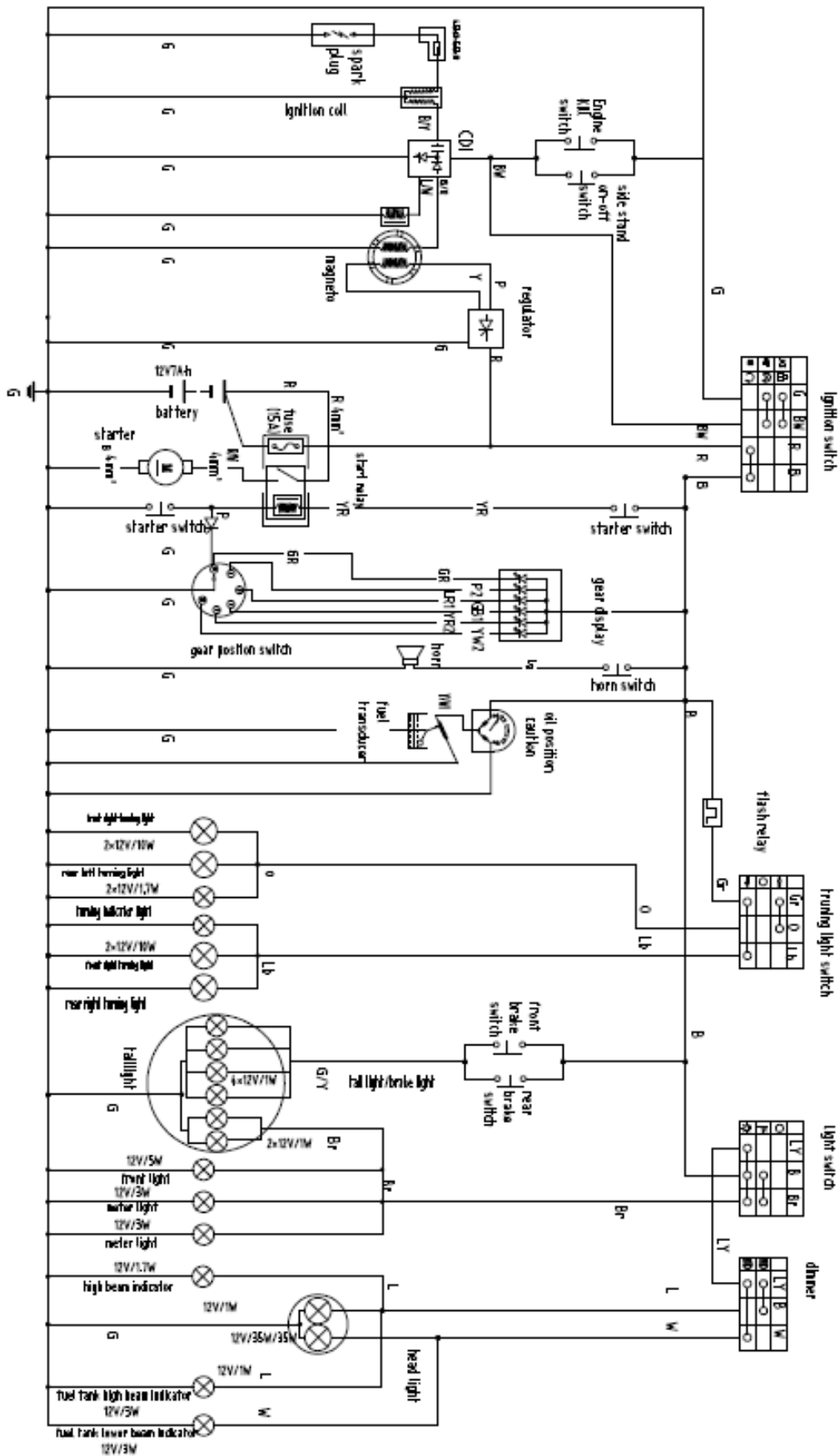

RICKY POWER SPORTS, LLC. – EMISSION CONTROL SYSTEM WARRANTY

YOUR WARRANTY RIGHTS AND OBLIGATIONS

The emission control system warranty period for this vehicle begins on the date the vehicle is delivered to the first purchaser other than an authorized dealer, or the date it is first used as a demonstrator, lease, or company vehicle, whichever comes first and continues for 30 months after that date, or 5,000km, whichever comes first, provided there has been no abuse, neglect or improper maintenance of your vehicle. Where a warrantable condition exists, Ricky Power Sports, LLC will repair your vehicle at no cost to you, including diagnosis, parts and labor. If an emission-related part on your vehicle is defective, the part will be repaired or replaced by the Ricky Power Sports, LLC. This is your emission control defects warranty.

OWNER'S WARRANTY RESPONSIBILITIES

As the vehicle owner, you are responsible for the performance of the required maintenance. You should maintain a record of all maintenance performed on your vehicle and retain all receipts covering maintenance on your vehicle. You may not be denied a warranty claim solely because of your failure to ensure the performance of all scheduled maintenance or lack of maintenance records or receipts. You are responsible for presenting your vehicle to an authorized dealer as soon as a problem exists. The warranty repairs should be completed in a reasonable amount of time, not to exceed 30 days.

As the vehicle owner, you should be aware that you may be denied your warranty coverage if your vehicle or a part has failed due to abuse, neglect, improper maintenance, or unapproved modifications.

WARRANTY COVERAGE

Ricky Power Sports, LLC warrants that each new 2022 and later vehicle:

- is designed, built, and equipped so as to conform at the time of initial retail purchase with all applicable regulations of the United States Environmental Protection Agency; and
- is free from defects in material and workmanship which cause such vehicle to fail to conform with applicable regulations of the United States Environmental Protection Agency for the periods specified above.

Your emission control system warranty covers components whose failure would increase an engine's emission, including electronic controls, fuel injection system, carburetor, the ignition system, catalytic converter, or any other system utilized in this vehicle to control emission if it is originally equipped. Also included may be hoses, connectors and other emission-related assemblies. Replacing or repairing other components (including parts, labor, and other costs) not covered by this emission control system warranty or the standard warranty is the responsibility of the owner.

Coverage of repairs under this warranty applies only when repairs are completed at an authorized dealer or repair facility. Ricky Power Sports, LLC will not cover repairs performed outside of an authorized dealer or repair facility. The use of replacement parts not equivalent to the original parts may impair the effectiveness of your vehicle's emission control system. If such a replacement part is used and an authorized dealer determines it is defective or causes a failure of a warranted part, your claim for repair to bring your vehicle into compliance with applicable standards may be denied.

This Emission Control System Warranty is in addition to the standard Limited Warranty.

EXCLUSIONS AND LIMITATIONS

This warranty does not cover the following:

- Failures or malfunctions of the emission control systems caused by abuse, alteration, accident, misuse, the use of leaded gasoline.
- Replacement of expendable maintenance items unless they are original equipment defective in material or workmanship under normal use, and the first required replacement interval for the item

has not been reached. Expendable maintenance items include but not limited to spark plugs, filters, coolant, lubricants, gaskets, hoses, and belts.

- Replacements of parts and other services and adjustments for required maintenance.
- Any vehicle equipped with an odometer or hour meter where the reading is altered so that actual mileage cannot be readily determined.
- Repairs or replacements as a result of:
 - Accident
 - Misuse
 - Use of replacement parts or accessories not conforming to the original specifications which adversely affect performance
- Physical damage, corrosion, or defects caused by fire, explosions or similar causes beyond the control of the Distributor.
- Failures not caused by a defect in material or workmanship.

Use of the vehicle in any type of competitive racing or related events immediately and completely voids this and all other warranties.

LIMITED LIABILITY

The liability of Ricky Power Sports, LLC under this Emission Control System Warranty is limited solely to the remedying of defects in material workmanship by an authorized dealer at its place of business during customary business hours. This warranty does not cover inconvenience or loss of use of the vehicle or transportation of the vehicle to/from the authorized dealer. Ricky Power Sports, LLC is not liable to any person for incidental, consequential or special damages of any description, whether arising out of express or implied warranty or any other contract, negligence or other tort or otherwise.

No express emission control system warranty is given by Ricky Power Sports, LLC except as specifically set forth herein. Any emission control system warranty implied by law, including any warranty of merchantability or fitness for a particular purpose is limited to the express emission control system warranty terms stated in this warranty. The foregoing statements of warranty are exclusive and in lieu of all other remedies. All express warranties not stated in this warranty are disclaimed. Some states do not allow limitations on how long an implied warranty lasts, so the above limitations may not apply if it is inconsistent with the controlling state law.

No dealer is authorized to modify this Emission Control System Warranty. If you have any questions regarding your warranty rights and responsibilities, you should contact Ricky Power Sports, LLC (1-844-250-2199).



Ricky Power Sports, LLC.

2425 Camp. Avenue,

Carrollton, TX 75006

Toll Free: 844-250-2199