



OWNER'S MANUAL

125cc ATV



Always wear a helmet: It could save your life!

NEVER permit children under age 10 to operate this ATV.

Do not remove the owner's manual from this vehicle.

Please obtain, review and follow provincial/municipal government acts and regulations pertaining to owning and operating an off-road vehicle.

“YOUR ATV CAN BE HAZARDOUS TO OPERATE. A collision or rollover can occur quickly, even during routine maneuvers such as turning and driving on hills or over obstacles, if you fail to take proper precautions.

For your safety, understand and follow all the warnings contained in this owner’s manual and the labels on your vehicle. Failure to follow these warning can result in SEVER INJURY OR DEATH.

Keep the owner’s manual with your vehicle at all times.”

WARNING

Failure to follow the age recommendations for this ATV. Failure to supervise children under 10 on ATV models intended for their use.

Use by children of ATVs that are not recommended for their age can lead to severe injury or death of the child. Even though a child may be within the age group for which an ATV is recommended, he or she may not have the skills, abilities, or judgment needed to operate the ATV safely and may be involved in a serious accident.

Category Y (Youth Model) ATV, An ATV of appropriate size intended for recreational use under adult supervision by an operator under age 16. Youth model ATVs can further be categorized as follows: Category Y-6+ ATV. A Category Y-6+ ATV is a youth model ATV that is intended for use by children age 6 or older. Category Y-10+ ATV. A Category Y-10+ ATV is a youth model ATV that is intended for use by children age 10 or older. Category Y-12+ ATV. A Category Y-12+ ATV is a youth model ATV that is intended for use by children age 12 or older. Category T (Transitional Model) ATV. A Category T ATV is an ATV of appropriate size that is intended for recreational use by an operator age 14 or older under adult supervision, or by an operator age 16 or older.

Congratulations on your purchase of 125cc sports ATV from dealers of Ricky Power Sports,LLC.

Your ATV is warranted to be free of manufacturing defects in material and workmanship for a period of 90 days from the date of purchase. During the warranty period Ricky Power Sports, LLC will at its option, repair, provide replacement parts or replace your 125cc sports ATV at no charge. This warranty does not cover normal wear items or damage caused by neglect or misuse of the product.

Engine Warranty – 90 days

Frame Warranty – 90 days

Warranty is void if:

Frame is bent or broken due to abuse

Wheels are bent or broken

Fender bent or broken due to abuse

Any sign of impact, accident, jumping, spin-outs or roll over.

Ricky Power Sports, LLC is not liable for any damage claim or liability claim person or otherwise resulting from the operation of this product in any way.

Should you experience a problem with your vehicle, please call your dealer or Ricky Power Sports, LLC. customer service line toll free at 1- 844-250-2199. You will be instructed how to proceed.

A COPY OF THE SALES RECEIPT IS REQUIRED.

WARNING

Operation of this ATV by children of under 10 age can be hazardous.

Use by children of under 10 can lead to their severe injury or death. Children under age 10 may not have the size, strength, skill of judgment needed to operate this ATV safely.

Do not allow any child under age 10 to ride this ATV.

WARNING

Operating this ATV after consuming alcohol or drugs can be hazardous.

Alcohol or drugs could seriously affect your judgment and cause you to react more slowly. They can also affect your balance and perception. Operating this ATV after consuming alcohol or drugs can result in an accident.

NEVER consume alcohol or drugs before ride this ATV.



WARNING

This manual should be considered a permanent part of the vehicle and should remain with the vehicle when resold or otherwise transferred to a new user or operator. The manual contains important safety information and instructions which should be read carefully before operating the vehicle.

PRS 125cc Sports ATV

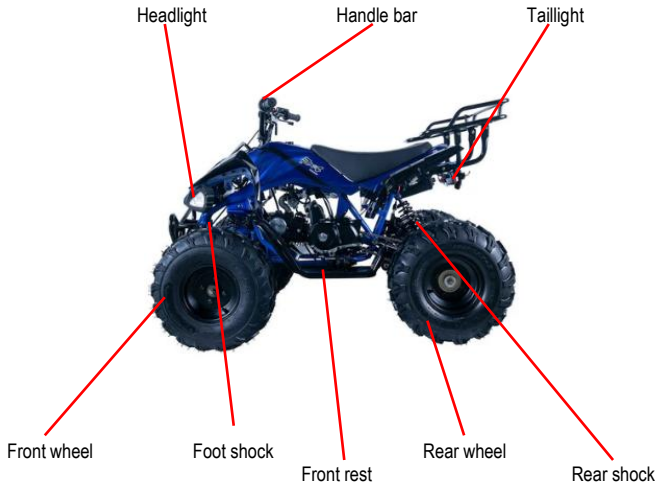

HOW TO READ THIS MANUAL

Please read this manual and follow all instructions carefully. To emphasize the special information, the symbol **▲** and the words **WARNING** or **CAUTION** have some special meanings. Pay great attention to the messages.

▲ WARNING-or-CAUTION
Indicates a potential hazard that could result in death or injury.

▲ CAUTION
Indicates a potential hazard that could result in vehicle damage.

NOTE: Indicating special information which is to make maintenance easier or instructions clearer.

WARNING and **CAUTION** are arranged like this:

▲ WARNING-or-CAUTION
The first part will identify a POTENTIAL HAZARD .
The second part will describe WHAT COULD HAPPEN if you ignore the WARNING or CAUTION .
The third part will describe HOW TO AVOID THE HAZARD .

This owner's manual contains important safety and maintenance information. Read it carefully before riding. Failing to follow the warnings contained in this manual could result in **INJURY** or **DEATH**.

It is important that this manual remain with the vehicle when you transfer it to another user or owner.

All information, illustrations, photographs and specifications contained in this manual are based on the latest product information available at the time of publication. Due to improvements or other changes, there will be some discrepancies in this manual. We reserve the right to make product changes at any time, without notice and without incurring any obligation to make the same or similar changes to the vehicle previously built or sold.

Table of Contents

NOTICE TO USERS.....	10
FUEL AND OIL.....	13
LOCATION OF LABELS AND SERIAL NUMBERS.....	14
LABEL.....	15
HANDLEBAR & CONTROL LAYOUT.....	17
LEFT HANDLEBAR.....	17
RIGHT HANDLEBAR.....	17
FUEL VALVE.....	18
FUEL TANK CAP.....	19
SEAT LOCK.....	21
WHAT YOU SHOULD KNOW BEFORE RIDING.....	21
INSPECTION BEFORE RIDING.....	23
BREAK-IN.....	24
WARNINGS.....	26
SAFETY GEAR.....	27
BASIC MOVEMENT AND SHIFTING.....	31
STARTING THE ENGINE.....	31
BRAKING.....	32
TURNING.....	33
OPERATION OF HILLS.....	35
CLIMBING A HILL.....	36
DESCENDING A HILL.....	36
RIDING OVER OBSTACLES.....	38
SKIDDING OR SLIDING.....	39
RIDING THROUGH WATER.....	41
RIDING IN COLD WEATHER.....	42
DRESSING FOR COLD WEATHER RIDING.....	43
RIDING YOUR ATV ON SNOW OR ICE.....	43
ACCESSORY USE AND VEHICLE LOADING.....	44
INSPECTION AND MAINTENANCE.....	45
TOOLS.....	47
SPARK PLUG.....	48
VALVE INSPECTION.....	49
BATTERY INSTALLATION.....	50
ADJUSTMENT OF THROTTLE LEVER.....	56
IDLE SPEED.....	57
FUEL HOSE.....	57
ENGINE OIL CHECK AND CHANGE.....	58
AIR CLEANER.....	60

DRIVE CHAIN.....63
DRIVE CHAIN CLEANING AND OILING64
TIRES.....66
BRAKES70
FRONT BRAKE ADJUSTMENT.....70
REAR DISC BRAKE.....71
GENERAL LUBRICATION.....73
TROUBLESHOOTING.....73
TRANSPORTING.....75
CLEANING PROCEDURE.....76
WASHING YOUR ATV.....77
STORAGE PROCEDURE.....78
SPECIFICATIONS.....79
CIRCUIT DIAGRAM.....81
EMISSION CONTROL SYSTEM WARRANTY82

NOTICE TO USERS

We believe in conservation and protection of the earth's natural resources. We encourage every vehicle owner and operator to do the same by obeying posted signs and riding only in areas designated and approved for off-road recreational use.

NOTICE TO PARENTS THIS ATV IS BUILT FOR USE BY CHILDREN AGE 16 AND OLDER, BUT THE USERS MANUAL IS WRITTEN FOR ADULTS WHO WILL BE SUPERVISING THE CHILDREN, WE STRONGLY RECOMMEND , THEREFORE, THAT YOU REVIEW THIS ENTIRE MANUAL WITH YOUR CHILD AND CAREFULLY EXPLAIN THE INSTRUCTIONS, REQUIREMENTS, AND WARNINGS IT CONTAINS SO THAT YOUR CHILD CAN UNDERSTAND THEM.

CHILDREN DIFFER IN SKILLS, PHYSICAL ABILITIES, AND JUDGEMENT. SOME CHILDREN MAY NOT BE ABLE TO OPERATE AN ATV SAFELY. PARENTS SHOULD SUPERVISE THEIR CHILD'S USE OF THE ATV AT ALL TIMES. PARENTS SHOULD PERMIT CONTINUED USE ONLY IF THEY DETERMINE THAT THE CHILD HAS THE ABILITY TO OPERATE THE ATV SAFELY.

IT IS VERY IMPORTANT THAT EVERY CHILD WHO RIDES THE ATV SHOULD COMPLETE A TRAINING COURSE.

THIS ATV IS NOT A TOY AND COULD BE HAZARDOUS TO OPERATE. An ATV handles differently from other vehicles including motorcycles and cars. A collision or rollover can occur quickly, even during routine maneuvers such as turning and driving on hills or over obstacles, if you fail to take proper precautions.

SEVERE INJURY OR DEATH can result if you do not follow these instructions:

- Read this manual and all labels carefully and follow the operating procedures described.
- Never operate an ATV without proper instruction. Take a training course. Beginner should receive training from a certified instructor. Contact an authorized ATV dealer about the training courses nearest you.
- Always follow these age recommendations:

Category Y (Youth Model) ATV. An ATV of appropriate size intended for recreational use under adult supervision by an operator no under age 10. Youth model ATVs can further be categorized as follows: Category Y-6+ ATV. A Category Y-6+ ATV is a youth model ATV that is intended for use by children age 6 or older Category Y-10+ ATV. A Category Y-10+ ATV is a youth model ATV that is intended for use by children age 10 or older. Category Y-12+ ATV.

A Category Y-12+ ATV is a youth model ATV that is intended for use by children age 12 or older. Category T (Transitional Model) ATV. A Category T ATV is an ATV of appropriate size that is intended for recreational use by an operator age 14 or older under adult supervision, or by an operator age 16 or older.

- **Never allow a child under age 10 to operate an ATV without adult supervision, and never allow continued use of an ATV by a child if he or she does not have the abilities to operate it safely.**

Never carry a passenger on an ATV.

- **Never operate an ATV on any paved surfaces, including sidewalks, driveways, parking lots and streets.**
- **Never operate an ATV on any public street, road or highway, even dirt or gravel one.**
- **Never operate an ATV without wearing an approved motorcycle helmet that fits the rider properly. You should also wear eye protection (goggles or face shield), gloves, boots, long-sleeved shirt or jacket, and long pants.**
- **Never consume alcohol or drugs before or while operating this ATV.**
- **Never operate this ATV at excessive speeds. Always go at a speed that improper for the terrain, visibility and operating conditions, and your experience.**
- **Never attempt wheelies, jumps, or other stunts.**
- **Always inspect your ATV each time you use it to make sure it is in safe operating condition. Always follow the inspection and maintenance procedures and schedules described in this manual.**
- **Always keep both hands on the handlebars and both feet on the footrests of the ATV during operation.**
- **Always go slowly and be extra careful when operating on unfamiliar terrain. Always be alert to changing terrain conditions when operating the ATV.**
- **Never operate on excessively rough, slippery or loose terrain until you have learned and practiced the skills necessary to control the ATV on such terrain. Always be especially cautious on these kinds of terrain.**
- **Always follow proper procedures for turning as described in this manual. Practice turning at low speed before attempt to turn at faster speed. Do not turn at excessive speeds.**
- **Never operate that ATV on hills too steep for the ATV or for your abilities. Practice on smaller hills before attempting larger hills.**

- Always follow proper procedures for climbing hills as described in this manual. Check the terrain carefully before you start up any hill. Never climb hills with excessively slipper or loose surfaces. Shift you weight forward. Never open the throttle suddenly or make sudden gear changes. Never go over the top of any hill at high speed.
- Always follow proper procedures for going down hills and for braking on hills as described in this manual. Check the terrain carefully before you start down any hill. Shift your weight backward. Never go down a hill at high speed. Avoid going down a hill at an angle that would cause the vehicle to lean sharply to one side. Go straight down the hill where possible.
- Always follow proper procedures for crossing the side of a hill as described in this manual. Avoid hills with excessively slippery or loose surfaces. Shift your weight to the uphill side of the ATV. Never attempt to turn the ATV around on any hill until you have mastered the turning technique described in this manual on level ground. Avoid crossing the side of a steep hill if possible.
- Always use proper procedures if you stall or roll backwards when climbing a hill. To avoid stalling, use proper gear and maintain a steady speed when climbing a hill. If you stall or roll backwards, follow the special procedure for braking described in this manual. Dismount on the uphill side or to a side if pointed straight uphill. Turn the ATV around and remount, following the procedure described in this manual.
- Always check for obstacles before operating in a new area. Never attempt to operate over large obstacles, such as large rocks or fallen trees. Always follow proper procedures when operating over obstacles as described in this manual.
- Always be careful when skidding or sliding. Learn to safely control skidding or sliding by practicing at low speeds and on level, smooth terrain. On extremely slippery surfaces, such as ice, go slowly and be very cautious in order to reduce the chance of skidding or sliding out of control.
- Never operate an ATV in fast flowing water or in water deeper than that specified in this manual. Remember that wet brakes may have reduced stopping ability. Test your brakes after leaving water. If necessary, apply brakes several times to let friction dry out the linings.
- Always use the size and type tires specified in this manual. Always maintain proper tire pressure as described in this manual.
- Never modify an ATV through improper installation or use of accessories.

- Never exceed the stated load capacity for an ATV. Cargo should be properly distributed and securely attached. Reduce speed and follow instructions in this manual for carrying cargo. Allow greater distance for braking.
- The combined weight of the rider and any accessories or cargo must never exceed the vehicle's max load capacity of 187 lbs (85 kg).
- Do not tow a trailer. This vehicle is not designed for such use.

FOR MORE INFORMATION ABOUT ATV SAFETY, call the Consumer Product Safety Commission at 800-638-2772, or call Ricky Power Sports LLC Hotline at 1-844-250-2199

FUEL AND OIL

FUEL The proper fuel is very important for the engine. Ensure that there is no dust or dirt, or water which has mixed in the fuel. Please use the regular unleaded gasoline with an octane of 87 or higher level.

Your 125cc ATV has a four-stroke engine. Please use oil as described in the chart below. By using the prescribe oil, you will realize the best lubrication for the engine.

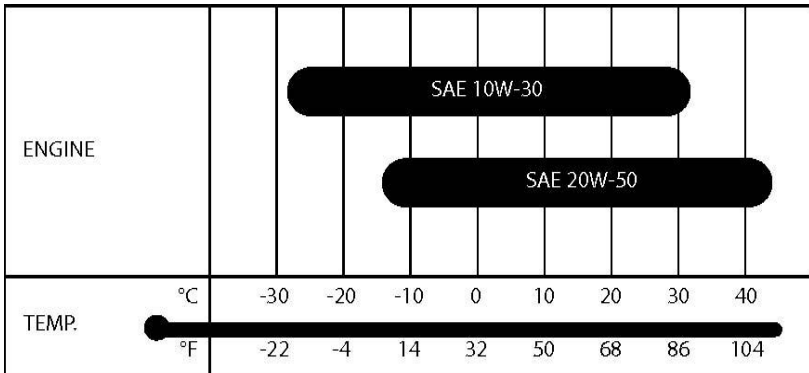

Use the chart to select a viscosity rating based on the temperature range in your area.

NOTE: In very cold weather (below 5°F (-15°C), use SAE 5W-30 or 5W-40 SF for good starting and smooth operation.

CHECKING THE OIL

Check the engine oil level prior to each use.

1. Start the engine and let it idle for a few minutes.
2. Stop the engine and put the vehicle on level ground.
3. After a few minutes remove the oil fill cap / dipstick, wipe it clean, and reinsert the dipstick without screwing it in.
4. Remove the dipstick and examine the oil level on the on the dipstick. The oil level should be between the upper and lower level marks on the dipstick.
5. If the oil falls below the lower level, add oil through the filler hole. It is very important to insure there is sufficient oil in the engine.



LOCATION OF LABELS AND SERIAL NUMBERS

SERIAL NUMBERS: You need to know the frame and engine serial numbers to get title documents for your ATV. You also need these numbers to help your dealer or Ricky Power Sports,LLC. order the parts.



FRAME SERIAL #



ENGINE SERIAL #

LABELS: Read and follow all of the warning labels on your ATV. Make sure you understand all the labels. Keep the labels on the ATV. Do not remove them for any reason. If a label comes off or becomes difficult to read, you should get a replacement by your dealer or Ricky Power Sports,LLC.



Affixed to the right front fender

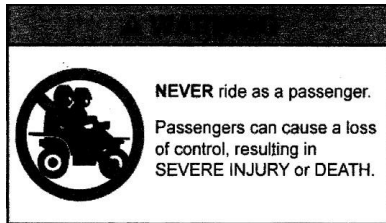

Affixed to the left rear fender

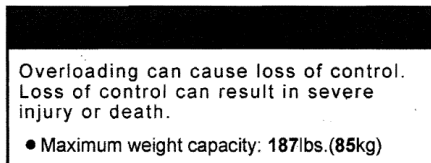

Affixed to the left rear fender

Following label is affixed to the left rear fender

Improper tire pressure can cause loss of control.
Loss of control can result in severe injury or death.

- Cold tire pressure:
Front : 2.9 psi (20.0 kPa)
Rear : 2.9 psi (20.0 kPa)

Following label is affixed to the left front fender

Improper ATV use can result in SEVERE INJURY or DEATH



ALWAYS USE AN APPROVED HELMET AND PROTECTIVE GEAR **NEVER USE ON PUBLIC ROADS** **NEVER CARRY PASSENGERS** **NEVER USE WITH DRUGS OR ALCOHOL**

NEVER operate:

- without proper training or instruction
- at speeds too fast for your skills or the conditions
- on public roads - a collision can occur with another vehicle
- with a passenger - passengers affect balance and steering and increase risk of losing control

ALWAYS:

- use proper riding techniques to avoid vehicle overturns on hills and rough terrain and in turns
- avoid paved surfaces - pavement may seriously affect handling and control

**LOCATE AND READ OWNER'S MANUAL.
FOLLOW ALL INSTRUCTIONS AND WARNINGS.**

HANDLEBAR & CONTROL LAYOUT

Left Handle Bar

- a **Engine Stop Switch:** With this switch in the “RUN” position, the engine can be started. The engine will not start with this switch in the “OFF” position.
- b **Start Button:** When the ignition key is in and turned to the “ON” position, the Engine Stop Switch is in the “RUN” position, this Button will start the engine.
- c **Front Drum Brake** Apply the front brake by squeezing the front brake lever towards the grip.
- d **Headlight Switch** This switch controls the operation of the headlights. Available positions are “HI” and “LO”.
- e **Front Parking Brake** Activate the front parking brake by squeezing front brake lever(c) and then moving the lock plate(e) into position to lock Front brake lever(c) into place.

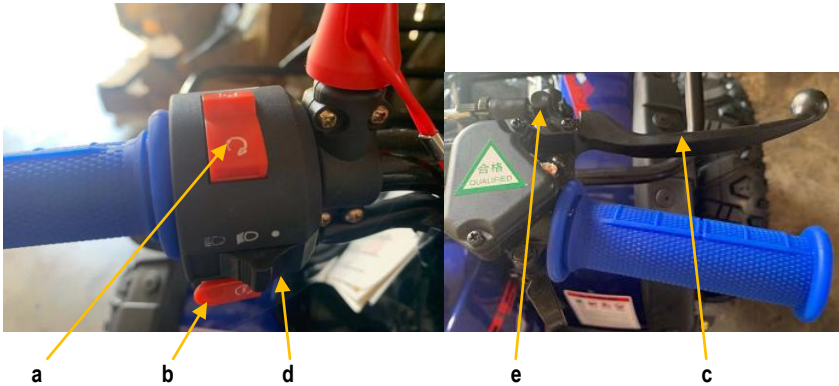

RIGHT HANDLEBAR

- a **Throttle Lever** This lever is controlled by the right hand thumb. The throttle Lever controls the speed of the engine, pushing the lever will increase the speed.
- b **Throttle Adjusting Screw**

Notice: This ATV was shipped from the factory with the CDI governor set to not allow the ATV to travel over 15mph (24km/h) out of the crate. Any change of CDI should be done by the dealer you purchase from, or a qualified service tech, working under the ATV or motorcycle service center. The CDI should never be changed to increase the speed of the ATV until the capability of the rider has been determined!

Or use the throttle adjusting screw to restrict maximum speed of the ATV. Adjust this limiter according to the rider's skill and experience!

Adjusting procedures. 1. Loosen nut. 2. Turn the throttle adjusting screw clockwise to restrict maximum speed of the ATV. 3. Turn the throttle adjusting screw counterclockwise to increase the maximum speed of the ATV. 4. When finished, tighten the lock nut.

c Front Brake Lever Squeeze the front brake lever to engage the brakes on the front tires.

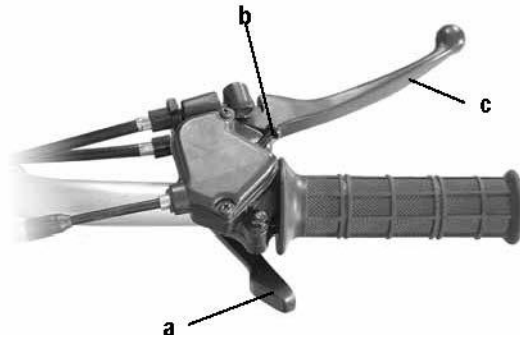

FUEL VALVE

This valve is located beneath the fuel tank, and has two positions.



“ON” position

“OFF” position

“OFF” position “ON” position The fuel valve set to “OFF”; fuel cannot flow. Use this position when the engine is not running.
The fuel valve set to “ON”; fuel can flow to the engine. The normal operating position.

Operating position

To open the fuel tank, remove the vent tube from the cap and rotate it counterclockwise. To replace the cap, turn it clockwise and tighten it securely. Be sure to replace the vent tube as shown.

Check fuel level before riding your ATV

Fuel tank cap



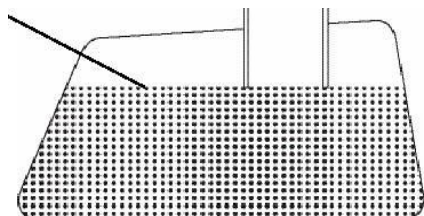

⚠ WARNING

Overfilling the fuel tank could be hazardous.

If you overfill the fuel tank, fuel may overflow when it expands. Expanding is due to heat from engine or sun. Overheated fuel could easily catch fire.

Stop adding fuel when the fuel level reaches the bottom of the filler neck.

⚠ WARNING

Improper fueling of the ATV could be hazardous.

Failing to follow safety precautions when refueling could result in a fire or let you to breathe toxic fumes.

Refuel in a well ventilated area. Make sure the engine is off and avoid spilling fuel on a hot engine. Do not smoke, and make sure there are no open flames or sparks in the area. Avoid breathing gasoline vapors. Keep children and pets away when you are refueling the ATV.

SEAT LOCK

To remove the seat, move the seat lock lever backward. Raise the rear end of the seat and slide it back.

To lock the seat, slide the seat lever into its retainer and push down firmly.



WHAT YOU SHOULD KNOW BEFORE RIDING

Before riding, you should read all the following information carefully. If you are properly prepared, you will have a more enjoyable ride.

Before riding, you should find a good place to practice the skills. Find a flat, open area with enough space to practice the new skills.

Operate this ATV without proper instruction.

The risk of an accident is greatly increased if the operator does not know how to operate the ATV properly in different situations and on different types of terrain.

For more information about the training course, contact an authorized ATV dealer or call the Consumer Product Safety Commission at 800-638-2772. For More information on ATV Safety please contact Ricky Power sports, LLC ATV Hotline at: 844-250-9199 to make sure that it is legal to ride in the area you selected. Review the local laws and make sure you

are not trespassing. Call the police if you don't know where you can ride. Protect your riding areas. When you are riding, remember to keep the terrain in good condition. Don't destroy plants, trees or other vegetation. Don't litter and don't bother wildlife. With your help, your riding area can remain open for use in the future. After you have found a good place to practice, review the control system on your ATV before riding. Learn to find these controls without looking for them, because you will not have time to look for them when you are riding.

INSPECTION BEFORE RIDING

ITEM TO CHECK	CONTENT
Steering	Smoothness; No restriction of movement; No play or looseness
Brakes	Proper brake lever free play; enough brake force; Parking brake effectiveness
Tires	Proper air pressure; Enough tread depth; No cracks, rips, or other damages
Fuel	Enough fuel for the intended trip; Fuel hose connected securely; No damage to fuel tank or cap; Fuel tank cap closed securely
Engine stop switch	Proper operation
Engine oil	Proper level – Check the oil by inspecting the Engine Oil indicator located at the bottom of the engine. The engine oil should completely fill the view window as indicated in the picture. Add oil if the window is not completely filled.
Throttle	Proper free play of throttle lever; Smooth response; Quick return to idle position
Drive chain	Proper tension; adequate lubrication; No excessive wear or damage
General condition	Bolts and nuts are tight; No rattle from any parts of the engine when running; No visible evidence of damage

▲ WARNING

Failing to inspect the ATV before operating could be hazardous. Failing to perform proper maintenance could also be hazardous.

Failing to inspect and maintain your ATV could increase the chances of an accident or equipment damage

Always inspect your ATV each time before riding, and make sure it is in a safe operating condition. Refer to the INSPECTION AND MAINTENANCE section in this manual.

▲ WARNING

Checking maintenance items when the engine is running could be hazardous.

You could be severely injured if your hands or clothing get caught in moving ATV parts.

Shut the engine off when performing maintenance checks, except checking the engine stop switch and throttle.

▲ CAUTION
Failure to follow Break-In procedures can significantly shorten the life of your vehicle.
By not following Break-In procedure, you risk causing excessive wear, and damaging the engine.
Be careful to correctly follow Break-in Procedure.

BREAK-IN

The first month is the most important in the life of your vehicle. Proper operation during this break-in period will be helpful for assuring maximum life and performance of your new vehicle. The following guidelines explain proper break-in procedures.

Maximum Throttle Opening Recommendation

During the first 10 hours of operation, you should always use less than ½ throttle opening.

Vary the Engine Rotating Speed Vary the engine rotating speed during the break-in period. This allows the parts to “load” and then “unload” (allowing the parts to cool). Although it is essential to place some stress on the engine components during break-in, you must be careful not to load the engine too much.

Avoid Constant Low Rotating Speed Operating the engine at constant low rotating speed (light load) can cause parts to glaze and not seal properly. Allow the engine to accelerate freely without exceeding the maximum throttle limit.

Allow the Engine Oil to Circulate Before Riding Allow a few minutes of idling time after warm or cold engine starting. This allows the lubricating oil to reach all critical engine components.

Observe your initial and most critical service. The initial service (break-in maintenance) is the most important service that your vehicle will receive. Observing a proper break-in operation, will help engine components seal properly. Maintenance required as part of the

initial service includes proper adjustments, tightening of all bolts & nuts, and replacement of dirty oil. Timely performance of this service will help you get the best service life and performance of the engine.

▲ WARNING

Carrying a passenger on this ATV.

Greatly reduces your ability to balance and control this ATV. Could cause an accident, resulting in harm to you and/or your passenger.



Never carry a passenger. The long seat is to allow the operator to shift position as needed during operation. It is not for carrying passenger.

▲ WARNING

Operating this ATV on paved surfaces.

The ATV's tires are designed for off-road use only, not for use on pavement. Paved surfaces may seriously affect handling and control of the ATV, and may cause the vehicle to go out of control.



Never operate the ATV on any paved surfaces, including sidewalks, driveways, parking lots and streets.

▲ WARNING

Operating this ATV on public streets, roads or highways.

You may collide with another vehicle.

Never operate this ATV on any public street, road or highway, even a dirt or gravel one. In many states is it illegal to operate ATVs on public streets, roads and highways.



▲ WARNING

Never operate this ATV at night. Night is defined as the period of time 30 minutes before sunset to 30 minutes after sunrise.

You may collide with another vehicle, a stationary object, or hazard found in the terrain.

SAFETY GEAR

A DOT approved motorcycle helmet is the most important part of your safety gear. A DOT approved motorcycle helmet can help prevent a serious head injury.

Choose a helmet that fits snugly. Motorcycle or ATV dealers can help in selecting a good quality helmet which fits it properly.

▲ WARNING

Operate this ATV without wearing an approved motorcycle helmet, eye protection and protective clothing.

Operating without an approved motorcycle helmet increases your chances of a severe head injury or death in the event of an accident. Operating without eye protection can result in an accident and increases your chances of a severe injury in the event of an accident.

Operating without protective clothing increases your chances of severe injury in the event of an accident.

Always wear an approved motorcycle helmet that fits properly, you should also wear:

- eye protection (goggles or face shield)
- gloves
- boots
- long-sleeved shirt or jacket
- long pants

▲ WARNING

Operating this ATV without wearing an approved motorcycle helmet, eye protection and protective clothing.

**Operating without an approved motorcycle helmet increases your chances of a severe head injury or death in the event of an accident.
Operating without eye protection can result in an accident and increases your chances of a severe injury in the event of an accident.
Operating without protective clothing increases your chances of severe injury in the event of an accident.**

Always wear an approved motorcycle helmet that fits properly.

You should also wear:

- eye protection (goggles or face shield)
- gloves
- boots
- long-sleeved shirt or jacket
- long pants

You should wear eye protection when you ride. If a rock or a branch hits your eyes, you could be severely injured. Wear goggles or a face shield.

Wear proper clothing when you ride. Proper clothes can protect you from injury. Wear a good pair of gloves, strong boots that are over the ankle, long pants, and a long sleeve shirt

▲ WARNING

Operating this ATV after consuming alcohol or drugs.

**Could seriously affect your judgement.
Could cause you to react more slowly.
Could affect your balance and perception.
Could result in an accident.**

Never consume alcohol or drugs before or while driving this ATV.

▲ WARNING

Operating this ATV at excessive speeds.

Increases your chances of losing control of the ATV, which can result in an accident.

Always go at a speed that is proper for the terrain, visibility and operating conditions, and your experience.

▲ WARNING

Attempting wheelies, jumps, and other stunts.

Increases the chance of an accident, including an overturn.

Never attempt stunts, such as wheelies or jumps. Don't try to show off.



▲ WARNING

Failure to inspect the ATV before operating.
Failure to properly maintain the ATV.

Increases the possibility of an accident or equipment damage.

Always inspect your ATV each time you use it to make sure the ATV is in safe operating condition.

Always follow the inspection and maintenance procedures and schedules described in the owner's manual.

▲ WARNING

Removing hands from handlebars or feet from the footrests during operation.

Removing even one hand or foot can reduce your ability to control the ATV or could cause you to lose your balance and fall off of the ATV. If you remove a foot from the footrest, your foot or leg may come into contact with the rear wheels, which could injure you or cause an accident.

Always keep both hands on the handlebars and both feet on the foot rests of your ATV during operation.

▲ WARNING

Failing to use extra care when operating this ATV on unfamiliar terrain.

You can come upon hidden rocks, bumps, or holes, without enough time to react. Could result in the ATV overturning or going out of control.

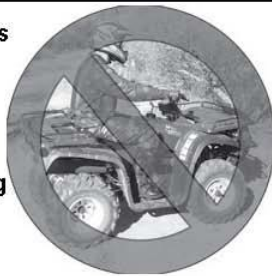

Go slowly and be extra careful when operating on unfamiliar terrain.

Always be alert to changing terrain conditions when operating the ATV.

▲ WARNING

Running your ATV indoors where there is little or no ventilation.

Breathing in exhaust gases from the ATV could cause severe injury.

Always run your ATV outdoors where there is fresh air.

BASIC MOVEMENT AND SHIFTING

STARTING THE ENGINE

Before attempting to start the engine, make sure to follow these steps.

1. Insert the ignition key and turn it to the "ON" position.
2. Turn the fuel valve to "ON".
3. Place the engine stop switch in the "RUN" position.
4. Set the parking brake.
5. Push the "START" button.
6. Push the throttle lever lightly.
7. Release the START button once the engine starts. Do not depress the START button for more than 5 seconds at a time. Release the starter button approximately 10 seconds before attempting to start the engine again.
8. Keep the throttle open slightly while warming up the engine. Make sure the engine is warm before attempting to ride. This ATV has an automatic clutch. Opening the throttle quickly will cause the ATV to move forward.

▲ WARNING

Failure to use extra care when operating on excessively rough, slipper or loose terrain.

Could cause loss of traction or vehicle control, which could result in an accident, including an overturn.

Do not operate on excessively rough, slippery or loose terrain until you have learned and practiced the skills necessary to control the ATV on such terrain. Always be especially cautious on these kinds of terrain.



▲ WARNING

The ATV may start moving as soon as you release the parking brake.

Unexpected movement could cause you to lose control of the ATV.

Make sure to apply the rear brake before you release the parking brake.

▲ WARNING

Opening the throttle suddenly could be hazardous.

The front wheels could leave the ground and cause loss of control of the ATV.

Always open the throttle gradually when you want to accelerate.

BRAKING

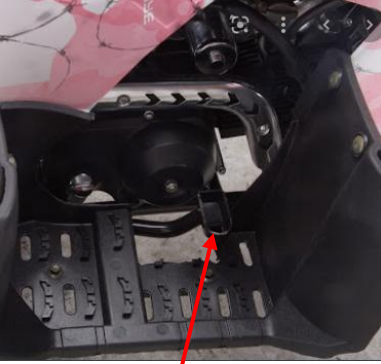

Rear Brake Pedal

To stop the ATV, please release the throttle lever and use rear brake pedal which is located on the foot board of right side.



Front Brake Lever

To stop the ATV when ATV runs at the low speed, please use front brake lever which is located on the right side of the handle grip.

▲ WARNING

Braking while turning the ATV could be hazardous.

Use of the brake when turning could cause the ATV to slide or roll over.

Use the brake to slow down before you begin to turn.

▲ WARNING

Braking hard on slippery surfaces could be hazardous.

The ATV could skid and go out of control if you brake too hard.

Apply the brakes lightly and carefully on slippery surfaces.

▲ WARNING

Operating the parking brake when the ATV is moving could be hazardous.

The front wheels could lock, and it will cause a skid and an accident.

Use the parking brake only after you stop the ATV.

TURNING

▲ WARNING

Turning improperly

ATV could go out of control, causing a collision or overturn.

Always follow proper procedures for turning as described in the owner's manual.

Practice turning at low speed before attempting to turn at faster speed.
Do not turn at excessive speed.

To turn the ATV, the rider must use the proper technique. Because this vehicle has a solid rear axle, both rear wheels always turn at the same speed. This means that if the rear wheels are getting equal traction, the vehicle will tend to move straight ahead. This is because the rear wheels will travel the same distance. For the vehicle to turn, the outside rear wheel must

travel a longer distance than the inside rear wheel. To make this happen, the rider must create less traction for the inside wheel, allowing it to skid. This allows it to travel a shorter distance than the outside wheel. This happens even though both wheels are still turning at the same speed.



To turn ATV, use the following technique:

- Move your body weight forward and to the inside of the turn.
- Turn the handlebar while looking in the direction of the turn.

FOR HIGHER SPEEDS OR SHARPER TURNS

Use the same technique that you use when you move your body weight farther toward the inside of the turn to maintain your balance. Natural turning forces (which can push the vehicle to the outside of the turn) increase as the speed or the turn sharpness increases. This means you must lean your body farther into the turn as you go faster or turn more sharply. This prevents the vehicle from tipping over to the outside of the turn. If your ATV starts to tip while turning, lean your body farther into the turn while gradually reducing the throttle and making the turn wider, if possible.

OPERATION OF HILLS

▲ WARNING

Operating on excessively steep hills.

The vehicle can overturn more easily on extremely steep hills than on level surfaces or small hills.

Never operate the ATV on hills too steep for the ATV or for your abilities.

Practice on smaller hills before attempting larger hills.

▲ WARNING

Climbing hills improperly.

Could cause loss of control or cause ATV to overturn.

Always follow the proper procedures for climbing hills as described in this owner's manual.

Always check the terrain carefully before you start up any hill.

Never climb hills with excessively slippery or loose surfaces.

Shift your weight forward.

Never open the throttle suddenly or make sudden gear changes. The ATV could flip over backwards.

Never go over the top of any hill at a high speed. An obstacle, a sharp drop, or another vehicle or person could be on the other side of the hill.



To climb a hill with the ATV, follow the directions below.

1. Speed up and maintain a steady speed before reaching the top of the hill. Remember that you must ride at a steady speed all the way to the top of the hill.
2. Shift your body forward by sliding forward on the seat. Lean slightly forward. For steep hills, stand on the footrests and lean forward.
3. Maintain a steady speed while climbing the hill.
4. Slow down gradually when you reach the top of the hill.

DESCENDING A HILL

▲ WARNING

Going down a hill improperly.

Could cause loss of control or cause ATV to overturn.

Always follow proper procedures for going down hills as described in the owners manual. NOTE: a special technique is required when braking as you go down a hill.

Always check the terrain carefully before you start down any hill.

Shift your weight backward.

Never go down a hill at high speed.

Avoid going down a hill at an angle that would cause the vehicle to lean sharply to one side. Go straight down the hill where possible.

To ride down a hill with the ATV, follow the instructions below.

1. Check the terrain carefully for any obstacles before you go down the hill.
2. Point the ATV straight down the hill.
3. Transfer your body to the rear by sliding back on the seat.
4. Ride down the hill slowly with the throttle released.
5. Apply the rear brake to control the speed.
6. Avoid going down a hill at an angle that would cause the vehicle to lean sharply to one side. Go straight down the hill if possible.



▲ WARNING

Improperly crossing hills or turning on hills.

Could cause loss of control or cause ATV to overturn.

Never attempt to turn the ATV around on any hill until you have mastered the turning technique as described in the owner's manual on level ground.

Be very careful when turning on any hill.

Avoid crossing the side of a steep hill if possible.

When crossing the side of a hill:

Always follow proper procedures as described in the owner's manual.

Avoid hills with excessively slippery or loose surfaces.

Shift your weight to the uphill side of the ATV.

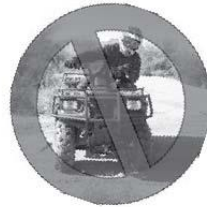

Stalling, rolling backwards or improperly dismounting while climbing a hill.

Could result in ATV overturning.

Use proper gear and maintain steady speed when climbing a hill.

If you lose all forward speed:

Keep weight uphill.

Apply brakes.

Lock parking brake, after you are stopped.

If you begin rolling backwards:

Keep weight uphill.

Never apply the rear brake while rolling backwards.

Apply the front brake.

When fully stopped, apply rear brake as well, and then lock the parking brake. Dismount on uphill side or to a side if pointed straight uphill. Turn the ATV around and remount, following the procedure described in the owner's manual.

DRIVING OVER OBSTACLES

▲ WARNING

Improperly operating over obstacles.

Could cause loss of control or a collision. Could cause the ATV to overturn.

Before operating in a new area, check for obstacles.

Never attempt to ride over large obstacles, such as large rocks or fallen trees.

When you go over obstacles, always follow proper procedures as described in the owner's manual.

If you come to an obstacle that you cannot avoid, you may be able to cross over it by using the following procedure.

1. If the obstacle is in front of you, approach at walking speed.
 2. Rise up slightly on the footrests.
 3. Pull up on the handlebar and apply a little throttle as the front wheels reach the obstacle.
 4. Lean forward and release the throttle after the front wheels are over the obstacle.
- Remember that some obstacles are too high for your ATV or for your abilities. If you are not sure that you can safely cross over an obstacle, back up and ride around the obstacle.

Skidding or sliding improperly.

You may lose control of this ATV. You may also regain traction unexpectedly, which may cause the ATV to overturn.

Learn to safely control skidding or sliding by practicing at low speeds and on level, smooth terrain.

On extremely slippery surfaces, such as ice, go slowly and be very cautious in order to reduce the chance of skidding or sliding out of control.

▲ WARNING

Skidding or sliding improperly.

You may lose control of this ATV.

You may also regain traction unexpectedly, which may cause the ATV to overturn.

Learn to safely control skidding or sliding by practicing at low speeds and on level, smooth terrain.

On extremely slippery surfaces, such as ice, go slowly and be very cautious in order to reduce the chance of skidding or sliding out of control.

SKIDDING OR SLIDING

You may experience skidding or sliding when you are not braking. You may be able to overcome it by using the techniques listed below.

If your front wheel skids:

Gain front wheel traction by reducing the throttle opening and leaning your body slightly forward.

If your rear wheel skids:

If space permits, steer in the direction of the skid. Shift your body away from the skid slightly. Avoid using the throttle or brakes until you regain directional control of the vehicle.

▲ WARNING

You can ride the ATV through shallow water. Make sure it is not more than 10cm (4 inches) deep and is not moving fast. Choose a good place to cross before you ride through the water. Look for a spot where the banks are gently sloped on both sides and the bottom of the stream is hard. If you are unfamiliar with the area, park the ATV and inspect the stream first to find a suitable spot for crossing.

When crossing, operate the ATV at a slow, steady speed. Be careful not to damage banks when crossing.

▲ WARNING

Operating this ATV through deep or fast flowing water.

Tires may float, causing loss of traction and loss of control, which could lead to an accident.

Never operate this ATV in fast flowing water or in water deeper than described in this owner's manual.

Remember that wet brakes may have reduced stopping ability. Test your brakes after leaving water. If necessary, apply the brakes several times to let friction dry out the linings.

▲ CAUTION

Operating the ATV in water, sand, or mud causes rapid brake wear.

Excessive brake wear could cause the brakes to be less effective.

After repeated operation of the ATV in these conditions, bring it to your authorized service center to have the brakes inspected and cleaned.

RIDING IN COLD WEATHER

Pre-ride Inspection Check that the throttle and all control levers move freely. Make sure that the footrests are free of ice or snow.

Move the ATV forward and backward to check that the wheels roll freely. If you cannot move the ATV, the tires may be frozen to the ground, or the brakes may be frozen to the wheels. If the tires are frozen to the ground, pour warm water around them to melt the ice. If the brakes are frozen, bring the ATV to a warmer area to thaw out the brakes.

After the engine has warmed up, check the brakes. Do this inspection on level ground and do not exceed the walking speed. Be sure to check the operation of both front and rear brakes. If the brakes do not work adequately, stop riding the ATV.

CAUTION

Using engine power to free up frozen wheels could damage your ATV.

Severe damage to the drive train may occur if you use engine power to free frozen wheels.

Before riding, manually move the ATV forward and backward to make certain that all wheels roll freely.

Bring the ATV to a warmer area to allow the brakes to thaw out. After the brakes thaw, dry them by applying them several times before riding. If the brakes do not regain full stopping power, ask your authorized service center to check them before you continue riding your ATV.

Water that enters the brakes may freeze after you park your ATV. The frozen water can prevent wheels from turning or the brakes from working. After riding through water, mud, snow or slush, it is important to dry the brakes before parking the ATV. To dry the brakes, apply them several times while riding slowly. Before your next ride, be sure to do a Pre-ride inspection as described earlier in this section.

▲ WARNING

Operating the ATV without a properly functioning brake system could be hazardous.

Wet or frozen brakes will increase stopping distance. This will increase your chance of having an accident.

Be sure to inspect the brakes before riding the vehicle in cold weather as described above.

▲ WARNING

Operating your ATV in cold weather without proper clothing could be hazardous.

Continued exposure in the cold weather could lead to hypothermia. Hypothermia is a condition where your body's inner temperature drops low enough to cause injury or death.

Always dress for the worst weather conditions you might encounter. Be prepared for bad weather and ATV breakdowns.

Riding in cold weather can be hazardous. At a temperature of 10°F (-12°C), the wind chill created by going just 10 mph (16km/h) makes you as cold as if you were standing still at a temperature of -9°F (-23°C). At this temperature, exposed flesh will freeze in just a few minutes.

Continued exposure in the cold weather could lead to hypothermia. Hypothermia occurs when your body's inner temperature drops. Symptoms include numbness in the extremities (hands, feet, arms, and legs), and shivering. Damp clothing contributes to hypothermia because cold water on your skin will drain heat from your body's core.

We strongly recommend that if you do any cold-weather riding, that you familiarize yourself with the symptoms, treatment, and prevention of hypothermia. Information is available at libraries and through government agencies.

Plan your winter rides with safety and comfort in mind. Dress for the worst conditions you might encounter. Be prepared for bad weather and ATV breakdowns. Wear warm, water-resistant clothing such as thermal underwear, snowmobile suits, lined gloves and boots, and wool socks.

▲ WARNING

Wearing loose clothing when riding your ATV could be hazardous.

Loose clothing, such as a long scarf or shawl, could get caught in an ATV's moving parts.

Never wear loose clothing when riding your ATV.

▲ WARNING

Riding on snow-covered terrain, even with care, could be hazardous.

The snow may be covering rocks, holes, ice or other hazards that can cause loss of control. Severe injury or death could occur if you lose control of the ATV.

Go slowly and be careful when riding on snow-covered terrain. Always be alert to changing terrain conditions.

▲ WARNING

Riding on a frozen lake or river could be hazardous.

Serious injury or death could occur if the ice breaks and you could fall into the cold water.

Check with local authorities to verify the thickness of the ice and areas to avoid.

▲ WARNING

Failing to use extra care when operating on slippery surfaces such as hard-packed snow and ice could be hazardous.

Failing to use extra care could cause loss of traction or loss of vehicle control. This could result in an accident, including an overturn.

Do not operate on slippery surfaces until you have learned and practiced the skills necessary to control the ATV on such terrain. Always use extra care on slippery surfaces. Avoid riding on the snow or ice covered hills whenever possible.

Practice riding your ATV in an open snow- or ice-covered area, at slow speeds, before handling out on snow- or ice-covered trails. Learn how your ATV responds to steering and braking on the type of terrain you will encounter on your ride.

Your eyes may be sensitive to sunlight when you ride over snow or ice on a bright, sunny day. Snow and ice reflects more light into your eyes than dirt or grass.

Tinted eye protection will reduce the amount of light reaching your eyes.

On overcast days, you may find it helpful to use yellow-tinted eye protection.

ACCESSORY USE AND VEHICLE LOADING

There are many types of accessories for sale. However, we cannot have direct control over their quality or suitability. We cannot test each accessory that is available. If you add the wrong accessories or misuse the vehicle with some accessories installed, it can make the ATV less safe to ride. Be cautious when choosing and installing accessories to your vehicle. Your retailer may be able to help you choose accessories and install them correctly. The guidelines below should help you to decide how to equip your ATV and how to use it correctly when you use accessories.

Accessory Use and Vehicle Loading Guidelines

1. The combined weight of the rider, tools, and any accessories or cargo must never exceed the vehicle's load capacity of 187lbs.
2. Check accessory mounting brackets and other attachments to make sure they provide a rigid non-movable mount.
3. Accessories added to the handlebar of the ATV should be as light as possible. The extra weight would cause the vehicle to be harder to steer.
4. Do not add accessories or cargo which interferes with controls or other equipment.
5. Do not carry heavy or bulky cargo.
6. Distribute cargo weight evenly between the front and rear of the vehicle as well as both sides of the vehicle. Locate cargo weight as close to the center of the vehicle if possible.
7. Secure your load well. Shifting weight can affect your ability to handle the vehicle safely.
8. Ride at slow speeds and avoid hills when carrying cargo. Carrying loads would affect the

stability and handling of your ATV.

9. Allow enough stopping distance. Stopping distance increases if you carry loads. Use engine braking as much as possible.

▲ WARNING

Operating this ATV with improper modifications could be hazardous.

Improper installation of accessories or modifications of the vehicle may cause changes in handling which could lead to an accident.

Never modify the ATV with improper installation or use of improper accessories. All parts and accessories added to the ATV should be genuine parts or their equivalent designed for use on this ATV. Install and use them according to their instructions. If you have any questions, contact your dealer.

INSPECTION AND MAINTENANCE

It is very important to inspect and maintain your ATV regularly. Follow the guidelines in the chart. The intervals between periodic services in months are shown. At the end of each interval be sure to perform the maintenance listed.

MAINTENANCE SCHEDULE

ITEM	Initial			Every	
	1 Month/ 20 hrs	3 Month/ 50 hrs	6 Month/ 100 hrs	6 Month/ 100 hrs	1 Year/ 300 hrs
Fuel Line			3	3	3
Spark Plug	1,3	1,3	1,3	1,3	1,3
Carburetor	3	3	3	3	3
Air Filter Element	Every 15–35 hours (more often in wet or dusty areas). Clean and replace if necessary.				
Valves	3		3	3	3
Drive Chain	2,3	2,3	2,3	2,3	2,3
Battery	1,3	1,3	1,3	1,3	1,3
Nut Bolt, Fasteners	3	3	3	3	3
Wheels	3		3	3	3
Steering System	3	3	3	3	3

Brake	3	3	3	3	3
Oil Strainer	1,3		1,3		1,3
Wheel Bearing	2,3	2	2,3	2,3	2,3
KnuckleShafts Steering Shaft			2	2	2

1 = clean 2 = lubricate 3 = adjust, inspect, replace if necessary.

▲ WARNING

Improper maintenance or failing to perform recommended maintenance could be hazardous.

If you perform improper maintenance or do not maintain your ATV you may have an accident.

Keep you ATV in good condition. The items in the Maintenance Schedule should be performed by a qualified person or an Authorized Service Center or call Ricky Power sports LLC hotline: 1-844-250-2199

▲ CAUTION

If you use your ATV under severe conditions, it will need maintenance more often than shown in the chart.

Operating your ATV under severe conditions causes more wear on your ATV. Severe conditions include operating under frequent full throttle, or in dusty, wet, sandy, or muddy areas. These conditions could cause the ATV to wear more quickly.

Perform maintenance more often than shown in the chart. If you have any questions regarding maintenance intervals, consult your authorized service Center.

▲ CAUTION

Using poor quality replacement parts could damage your ATV.

Poorly-made replacement parts could cause your ATV to wear more quickly and shorten its useful life.

When replacing parts on your vehicle, use only genuine replacement parts or their equivalent.

TOOLS

A tool kit is provided with your ATV.



SPARK PLUG

Your ATV is equipped with TORCH or equivalent level spark plug. To determine if the standard spark plug is in good condition, check the color of the plug's center electrode insulator after vehicle operation. A brown color indicates that the plug is correct. A white or dark insulator indicates that the engine may need adjustment, or another plug type may be needed. Consult your authorized dealer or Ricky Power Sports LLC if your plug insulator is not a light brown color.

CAUTION

▲ CAUTION

Failing to use the proper spark plug could damage your ATV.

An improper spark plug may have an incorrect fit or heat range for your engine. This may cause severe engine damage which may not be covered under warranty.

Use only spark plug recommended for this engine. Call Baja Motorsports if you are not sure which spark plug is correct for your vehicle.

▲ CAUTION

Improper installation of the spark plug could damage your ATV.

An overly tight or cross threaded spark plug will damage the aluminum threads of the cylinder head.

Carefully turn the spark plug by hand into the threads. If the spark plug is new, tighten it with a wrench about 1/2 turn past finger tight. If you are reusing the old spark plug, tighten it with a wrench about 1/8 turn past finger tight.

▲ CAUTION

Dirt could damage your ATV if it entered an open spark plug hole of cylinder head.

Dirt could damage engine parts that move.

Cover the spark plug hole while the spark plug is out of the hole.

To maintain a proper functioning spark plug, keep the plug free of carbon. Remove carbon from the plug with a wire or pin, and adjust the gap to 0.6-0.8mm for good ignition. Use a thickness gauge to check the gap.

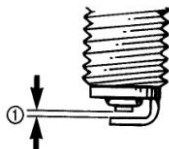

VALVE INSPECTION

REFER TO MAINTENANCE SCHEDULE IN THIS OWNER'S MANUAL FOR VALVE ADJUSTMENT INSPECTION INTERVALS.

Valve clearance should be:

Intake: 0.03-0.06 mm

Exhaust: 0.03-0.06mm

The engine will make excess noise if the gap is too large in air valve. If gap is too small valve operation will be hindered which could result in valve malfunction and failure. Therefore, air valve gap must be checked periodically.

If you have the proper tools and are mechanically proficient, instructions on adjusting the valve clearance are given in the service manual. If assistance is needed please contact Ricky Power Sports LLC to find your local dealers.

BATTERY INSTALLATION INITIAL SERVICE AND INSTALLATION OF BATTERY:



⚠ WARNING

The following procedure is very dangerous and should be performed with utmost care and attention. Wear protective eye wear, rubber gloves, and have water available should electrolyte come in contact with skin or eyes. **KEEP ALL CHILDREN AWAY FROM THE AREA WHILE THIS PROCEDURE IS BEING PERFORMED.**

POISON – CAUSES SEVERE BURNS

Contains sulfuric acid.

Avoid contact with skin, eyes, or clothing

To prevent accidents, rinse empty container with water.

ANTIDOTE:

External – flush with water

Internal – Call physician immediately. Drink large quantities of water or milk.

Follow with milk of magnesia, beaten eggs or vegetable.

Eyes – Flush with water for 15 minutes and get prompt medical attention.

KEEP OUT OF REACH OF CHILDREN.

Note: The following page is for vehicles with battery's containing separate electrolyte pack. Most battery's will come with the electrolyte already sealed into the battery.

Preparing the battery:

- Place battery on level surface. Remove sealing tape from top. (See figure 1)
- Take the electrolyte container out of the plastic bag.
- Place electrolyte container upside down with the sealed silver mouths of the electrolyte bottles in line with the six filler holes of the battery. (See figure 2)
- Push the container down strongly enough to break the silver seals. (See figure 3) · As electrolyte starts flowing into battery, air bubbles will come up from the mouths of the plastic electrolyte bottles.
- Leave bottles upside down in battery holes until electrolyte is completely drained.
- Never leave children unattended around battery.
- If air bubbles cease to float to the top of the electrolyte bottles, tap lightly on top.
- DO NOT remove container from battery while it is draining.
- Never cut or pierce electrolyte container.
- After all the electrolyte has drained from the bottles into the battery, pull plastic electrolyte bottles gently out of the battery.
- Discard empty electrolyte bottles in a waste area that is inaccessible to children and animals.
- After filling let battery stand for at least 30 minutes before charging. This allows the electrolyte to penetrate plates for optimum performance and ensures longer battery life.

After 30 minutes the battery is ready for its initial charge. Place cap strip loosely over the filling holes as shown in the picture. (See figure 4)



Figure 1



Figure 2



Figure 3



Figure 4



Figure 5

How to Initially Charge the battery:

1. Connect the red positive (+) cable to the red positive (+) pole of the battery. (See figure 5)
2. Connect the black negative (-) cable to the black negative (-) pole of the battery. (See figure 6)

Note: The red positive (+) cable has a larger diameter than the black negative y cable.

3. Charging rate: Charge battery @ 0.7 Amps for 5 ~ 10 hours.
- After charging is complete, press down firmly with both hands to seat the caps. (Do not pound or hammer.) The battery is now sealed. (See figure 7)
 - Install battery in the ATV and make sure it is secured properly. (See figure 8) · Once battery is firmly seated in battery compartment, attach the red positive wire to the red positive terminal on the battery. (See figure 9)
 - Then attach the black negative wire to the black negative terminal on the battery. (See figure 10)



Figure 6

⚠ WARNING



Figure 7



Figure 8



Figure 9

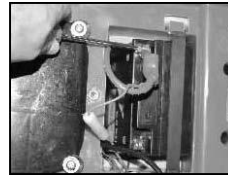

Figure 10

NEVER REMOVE THE STRIP OF CAPS NOR ADD ANY WATER OR ELECTROLYTE.

Battery Replacement:

- Remove old battery. Mark which cable is connected to the positive terminal (+) and which cable is connected to the negative (-) terminal.
- Clean cable connectors with wire brush or sandpaper to remove oxidation.
- After charging, install new battery. Put dielectric grease on the battery terminals to avoid corrosion. Connect cables to the proper terminals. Positive cable to positive terminal and negative cable to negative terminal y.
- Positive (+) cable is red and larger in diameter. Negative y cable is black and smaller of the two in diameter. **CONNECT NEGATIVE CABLE LAST.**
- Torque terminal bolts to 40 in. / lbs.
- Place rubber pad in bottom of battery tray.
- Securely fasten battery to the vehicle using cover and strap.

▲ WARNING

- **DO NOT** open sealed caps to add water to battery.
- Always wear safety glasses and charge in a ventilated area.
- If battery gets hot to the touch, discontinue charging and allow battery to cool down.
- Do not use fast charging unless it is an emergency.
- At the beginning or end of charging, turn off the charger first, in order to prevent electric spark and explosion. Charge in a well ventilated area.
- **DO NOT** smoke around batteries and keep away from open flame.

▲ WARNING

- To avoid possibility of explosion, always connect battery cable in the order specified: **RED** first; **BLACK** last. An exploding battery can cause

serious injury or death.

- Batteries contain sulfuric acid.
- Always shield eyes with protective eye wear when working around battery acid.
- Battery acid is poisonous and can cause severe burns.
- DO NOT smoke around batteries and keep away from open flame.

THE ADJUSTMENT OF THROTTLE LEVER

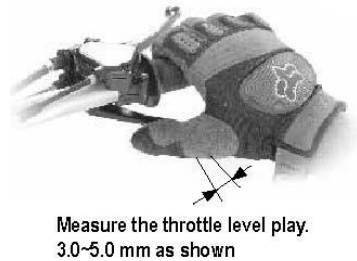
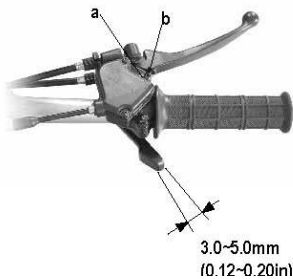

To adjust the throttle lever free distance:

1. Loosen the nut (a)
2. Turn the adjuster (b) in or out to obtain the correct play.
3. Tighten the nut (a).
4. Recheck the throttle lever free distance. Readjust if it is not within the correct limits.

⚠ WARNING

Operating the vehicle with an inadequate throttle lever free distance could be hazardous.

Inadequate throttle lever free distance could cause engine speed to rise suddenly when you turn the handlebars. This can lead the rider to lose control.

Adjust the throttle lever free distance so that engine idle speed does not rise due to handlebar movement.

Carburetor idle speed

The idle speed CAN NOT BE ADJUSTED BY EPA REGULATION:

1. The idle speed of the engine is sealed that can not be adjusted by EPA regulation
2. Manufacturer has set up the appropriate idle speed is at 1500 ± 150 r/min.

FUEL HOSE

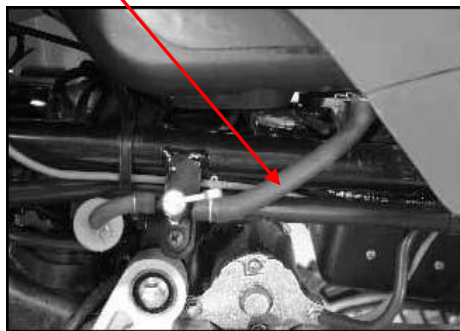

Inspect the fuel hose for damage and fuel leakage. If any defects are found, the fuel hose must be replaced, call Ricky Power Sports.LLC hotline: 844-250-2199 to get EPA approved fuel hose.

ENGINE OIL

The engine oil should be changed after the break in of first 50 mileages and should be changed by every 200 or 300 mileages. It should be changed more often in dirty and dusty areas.



Engine oil dip stick location

ENGINE OIL CHECK AND CHANGE



Engine oil dip stick



Engine oil drain bolt

1. Remove the drain bolt and allow oil to drain into an approved container.
2. Re-install the drain bolt
3. Add fresh oil of the specified type (see page 13, fuel and oil).

NOTE: Approximately 1 Qt (1L) of oil is required.

1. Tighten the oil cap.
2. Dispose of used oil as per governmental regulations.

▲ WARNING

New and used oil could be hazardous.

Children and pets may be harmed by swallowing new or used oil. Continuous contact with used oil can cause skin cancer in laboratory animals. Brief contact with the used oil may irritate the skin.

Keep new and used oil away from children and pets. To minimize your exposure to used oil, wear a long-sleeve shirt and moisture-proof gloves (such as dish washing gloves) when changing oil. If oil contacts your skin, wash thoroughly with soap and water. Launder any clothing or rags if wet with oil. Recycle or properly dispose of used oil.

▲ CAUTION

Failure to use the correct oil could harm your ATV.

Be sure to use the oil specified in the FUEL AND OIL RECOMMENDATION section.

▲ CAUTION

Running the engine without an adequate amount of engine oil could cause severe engine damage.

Running the engine without any engine oil could cause engine overheating.

Always check the amount of engine oil before starting the engine.

AIR CLEANER

The air cleaner element must be kept clean to provide good engine power. If you use your vehicle under normal, low-tension conditions, you should service the air cleaner at the intervals specified. If you ride in dusty, wet, or muddy conditions, you will need to inspect the air cleaner element much more frequently. Use the following procedures to remove the element and inspect it.



Air cleaner

⚠ WARNING

Operating the engine without the air cleaner element in place could be hazardous.

If the air cleaner element did not filter dirt, severe engine damage would occur if the dirt entered the running engine.

Never run the engine without the air cleaner element in place.

⚠ CAUTION

Failing to inspect the air cleaner element frequently if the vehicle is used in dusty, wet, or muddy conditions could damage your ATV.

The air cleaner element could become clogged under these conditions, and engine damage may result.

Always check the air cleaner element after riding in severe conditions. Clean or replace the elements as necessary. If water gets in the air cleaner case, immediately clean the element and the inside of the case.

REMOVAL

The air cleaner accumulates dust and must be cleaned periodically. If the ATV is ridden in dusty areas, the air cleaner must be cleaned at more frequent intervals than specified in the Maintenance Schedule. If the ATV is submerged in water, the air cleaner should be checked and water should be drained from the air cleaner housing before starting the engine.

Please remove the screws as following photos to check air cleaner.

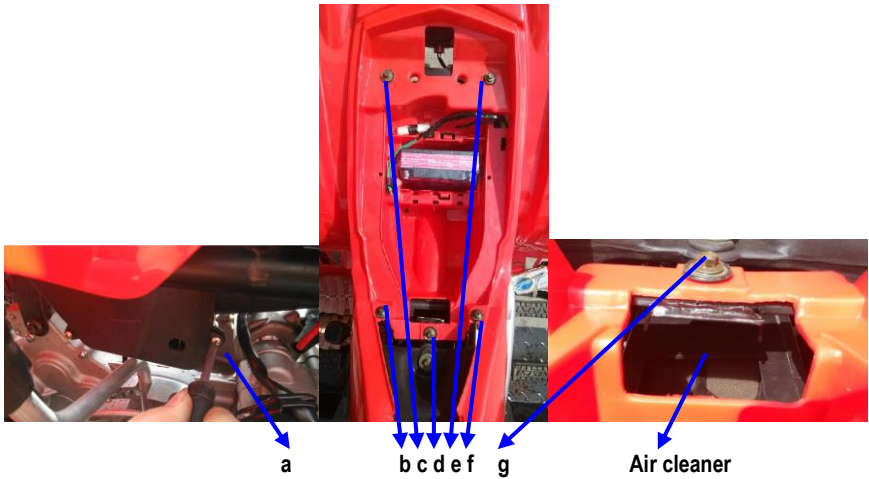

WASHING THE ELEMENT

1. Gently wash the air cleaner in clean, non-flammable (high flash point) solvent such as kerosene-not gasoline. Allow the air cleaner to dry thoroughly before applying oil. A wet air cleaner will not fully absorb the oil. NOTE: The element should be wet but not dripping.
2. Soak the air cleaner an equivalent (gear oil: SAE 80-90) until saturated, then squeeze out the excess oil. NOTE: The element should be wet but not dripping.

Twisting the air cleaner when squeezing out excess oil could damage the air cleaner. Reassemble by reversing the disassembly sequence.

▲ WARNING

Using gasoline or low flash point solvents for cleaning ATV parts.

A fire or explosion could result.

Use only a nonflammable or high flash point solvent to clean ATV parts.

▲ WARNING

Oil and solvent could be hazardous.

Children and pets could be harmed from the oil and solvent.

Be sure to keep oil and solvent away from children and pets. Dispose of used oil and solvent properly.

▲ CAUTION

A torn air filter could damage your ATV.

Dirt and dust may get inside of the engine if the element is torn.

Examine carefully the element for tears before and after cleaning it.
Replace the element with a new one if it is torn.

▲ CAUTION

Failing to position the air cleaner element properly could damage your ATV.

Air will bypass the air cleaner element if the element is not positioned properly. This will cause the engine parts to wear more rapidly.

Be sure to position the air cleaner element properly.

DRIVE CHAIN

The condition and adjustment of the drive chain should be checked before riding. Always follow the guidelines below for inspecting and servicing the chain.

WARNING

Failing to maintain the chain properly before each riding could be hazardous.

Riding with the chain in poor condition could lead to an accident.

Be sure to inspect and maintain the chain before riding, according to these guidelines.

Inspecting the Drive Chain

When inspecting the chain, look for the following:

- Loose pins
- Excessively worn teeth
- Damaged rollers
- Broken or damaged teeth
- Dry or rusted links
- Loose sprocket mounting nut(s)
- Kinked or binding links
- Excessive wear

If you find anything wrong with the drive chain, solve the problem if you can. If necessary, consult your authorized service center.

The drive chain is damaged means that the sprockets may also be damaged. Inspect the sprockets as specified below:

DRIVING CHAIN CLEAN AND OILING

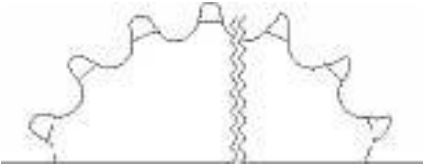

If you find any of these problems with your sprocket, consult Ricky Power Sports LLC or your local service center.

DRIVE CHAIN CLEANING AND OILING

Clean and oil the chain as the following:

Steam cleaning, high-pressure washers, and certain solvents can damage the drive chain. Use only kerosene to clean the chain. Wipe it dry, and thoroughly lubricate it with SAE 30~50 motor oil. Do not use any other lubricants on the drive chain.

Adjusting the Drive Chain

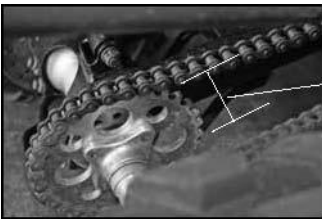

10~20 mm (0.39~0.79 in)

The drive chain should be adjusted while all four tires are on the ground and make sure there is 10~20 mm (0.39 ~ 0.79 in) of slack, as shown above. If the vertical deflection exceeds 20mm (0.79 in), adjust the chain slack. You can adjust the drive chain as the following:

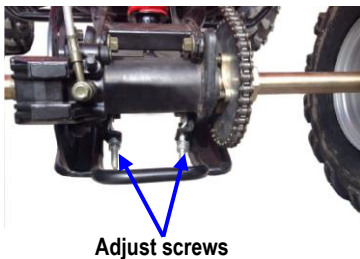

Adjust screws

Adjust two screws clockwise to tighten the chain, and turn two screws counterclockwise to make sure the chain be loosen.

▲ WARNING

Failing to inspect the drive chain slack before each use of the ATV could be hazardous.

Too much chain slack could cause the chain to come off the sprockets, resulting in an accident or serious damage to the ATV.

Inspect the drive chain slack before each use.

TIRES

▲ WARNING

Operating this ATV with improper tires, or with improper or uneven tire pressure.

Use of improper tires on this ATV, or operation of this ATV with improper or uneven tire pressure, may cause loss of control, increasing your risk of an accident.

Always use the size and type of tires specified. Always maintain proper tire air pressure as described in this section.

▲ WARNING

Using worn tires could be hazardous.

The traction of the vehicle will be decreased. This increases your risk of having an accident.

Replace the front and rear tires when the depth on the tread is 4.0 mm (0.16 inches) or less.

▲ WARNING

Operating this ATV with improper modifications.

Improper installation of accessories or modifications to this vehicle may cause changes in handling which in some situations could lead to an accident.

Never modify this ATV through improper installation or use of accessories. Any questions please consult Ricky Power Sports LLC authorized dealers.

▲ WARNING

Overloading this ATV or carrying or towing cargo improperly.

Could cause changes in vehicle handling which could lead to an accident.

Never exceed the stated load capacity for this ATV.

Cargo should be properly distributed and securely attached.

Reduce speed when carrying cargo. Allow greater distance for braking.

Always follow the instructions in your owner's manual for carrying cargo.

TIRES

The ATV is equipped with low pressure tubeless tires of the size and type listed below:

Front :AT19 x 7-8

Rear: AT18 x 9.5-8

Tire Tread Condition

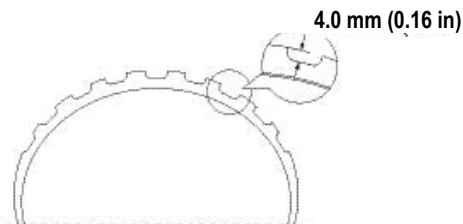

▲ WARNING

Using worn tires could be hazardous.

The traction of the vehicle will be decreased. This increases your risk of having an accident.

Replace the front and rear tires when the depth on the tread is 4.0 mm (0.16 in) or less.

Tire Air Pressure

Check the air pressure in all tires before riding. Improper air pressure would affect handling, steering response, traction, tire life and rider comfort. Be sure that the tires are inflated to the pressures shown below. Tire pressure should only be measured or adjusted when the tires are cold.

Cold Tire Air Pressure

Front 10 psi (69 kpa)

Rear 5 psi (34.5 kpa)

WARNING

Overfilling the air to the tires could be hazardous.

If you put too much air into the tire, may burst, and causing severe injury.

Check the air pressure from time to time while inflating the tire gradually, until the specified air pressure is obtained.

Overfilling the air to the tires could be hazardous.

If you put too much air into the tire, may burst, and causing severe injury.

Check the air pressure from time to time while inflating the tire gradually, until the specified air pressure is obtained.

Tire Replacement Your ATV has low-pressure tubeless tires. Air is sealed by the contact surfaces of the inner wheel rim and the tire bead. If the inner wheel rim or tire bead is damaged, air may leak. Be extremely careful not to damage these sections when replacing tires. It is very important to use the proper tools when repairing or replacing tires in order to protect the tire bead or wheel rims. Have this work done by your dealer or a qualified tire repair station.

When breaking the tire bead loose from the wheel, be extremely careful not to damage the inner wheel rim surface or the tire bead. Using tires that have been installed incorrectly could be hazardous.

The ATV may have unusual handling if the tires are installed incorrectly.

The tires are intended to rotate in a specific direction, as indicated by the arrows on the sidewall of each tire. Install tires correctly so they rotate in the proper direction. Tubeless Tire Repair

▲ WARNING

Using tires that have been installed incorrectly could be hazardous.

The ATV may have unusual handling if the tires are installed incorrectly.

The tires are intended to rotate in a specific direction, as indicated by the arrows on the sidewall of each tire. Install tires correctly so they rotate in the proper direction.

If a leak or flat tire occurs due to a puncture, the tire may be repaired using a plug type patch. If the damage is from a cut, or if the puncture cannot be repaired using a plug, the tire should be replaced. When operating your ATV in areas where transportation or service facilities are not readily available, it is strongly recommended that you bring a plug type repair kit and a tire air pump with you.

BRAKES

The ATV has two front drum brakes and a rear disk brake.

▲ WARNING

Failing to inspect and maintain your ATV's brake system properly could be hazardous.

Improper maintenance of the brake increases your chance of having an accident.

Be sure to inspect the brake before riding according to the **INSPECTION BEFORE RIDING** section. Always maintain your brakes according to the **MAINTENANCE SCHEDULE**.

▲ WARNING

▲ WARNING

Operating the ATV in harsh conditions could be hazardous if you do not inspect brake wear often.

Operating in mud, water, sand, or other extreme conditions can cause accelerated brake wear. This could lead to an accident.

If you operate your vehicle under these conditions, the brake must be inspected more often than recommended in the **MAINTENANCE SCHEDULE**.

Front Brake Adjustment

Try to move the vehicle backward and forward when the brake is applied. If the front wheels can turn, adjust the brake to lock the wheels securely.

Measure the amount of free play needed to lock the brake lever, as shown in above, if necessary. The free play is about 4~6mm (0.16~0.24in).

3. After any adjustment of the brake, check again to make sure the front wheels cannot turn when the brake is applied.



Rear Disk Brake Pedal

1. Inspect the disk brake for leakage. If the brake fluid leaks, the safety of riding could be affected.
2. Inspect the brake hose for cracks, and the joint for leakage.

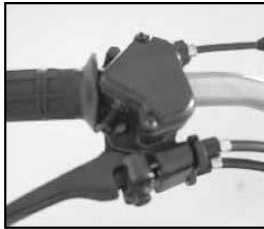

▲ WARNING

Failing to maintain the brake shoes or pads could be hazardous.

Riding with worn brake shoes, pads, or shoes that are seriously worn, will increase your chance of having an accident.

If you need to replace brake shoe pads, have your authorized service center do the work. Inspecting and maintaining the brake shoe pads is recommended. Replace the shoe pads in sets.

▲ WARNING

Brake fluid can be hazardous to humans and pets.

Brake fluid is harmful or fatal if swallowed, and harmful if it comes in contact with your skin or eyes.

Keep brake fluid away from children and pets. Call your doctor immediately if brake fluid is swallowed, and induce vomiting. Flush eyes or skin with water if brake fluid gets in eyes or comes in contact with skin.

▲ WARNING

Failure to use proper brake fluid can be hazardous.

The use of any fluid except DOT4 brake fluid from a sealed container can damage the brake system and lead to an accident.

Use only DOT4 brake fluid from a sealed container. Never use or mix with different types of brake fluid.

GENERAL LUBRICATION

Proper lubrication is important for safe, smooth operation and long life of your vehicle. Be sure that all lubrication is performed during periodic maintenance on the vehicle. Increase intervals when you use your ATV in severe conditions. Your authorized service center should do general lubrication as shown in the MAINTENANCE CHART. The authorized service center will lubricate the vehicle such as wheel bearings, swing arm bearings, steering shaft holder, cables, etc.

OOil

GGrease

Steering shaft holder

Brake cable

Drive chain

Throttle cable

Throttle lever

TROUBLESHOOTING

This troubleshooting guide is provided to help you to find the cause of some common complaints.

COMPLAINT: Engine is hard to start or does not start at all. Something is probably wrong with the fuel system or ignition system.

▲ CAUTION

Failing to troubleshoot a problem correctly would damage your ATV.

Improper repairs or adjustments may damage the vehicle. Such damage may not be covered under warranty. If you are not sure about the proper action, consult your authorized service center or Baja Motorsports about the problem.

Fuel Supplying Check

1. Make sure there is adequate fuel in the fuel tank.
2. Check that the engine stop switch is in the RUN position.
3. Check that the fuel valve is in the ON position.
4. Make sure there is enough fuel reaching the carburetor from the fuel tank.

▲ WARNING

Draining fuel from the carburetor could be hazardous.

Fuel could catch fire if you do not handle it properly.

When draining the carburetor, be sure to shut the engine off. Do not smoke, and never drain or refuel in an area where there are open flames or sparks. Do not spill the fuel or you may create a fire hazard. Dispose of drained fuel properly.

▲ WARNING

Draining fuel from the carburetor could be hazardous.

Fuel could catch fire if you do not handle it properly.

When draining the carburetor, be sure to shut the engine off. Do not smoke, and never drain or refuel in an area where there are open flames or sparks. Do not spill the fuel or you may create a fire hazard. Dispose of drained fuel properly.

- a. Loosen the drain screw which is located under the carburetor. Drain the fuel from the carburetor into a container.
 - b. Tighten the drain screw.
 - c. Run the engine for a few seconds. Shut off engine.
 - d. Loosen the drain screw and check that the carburetor is filled back up with fuel.
- e. If fuel is reaching the carburetor, the ignition system should be checked next.

Ignition System Check

1. Remove the spark plug and reattach it to the spark plug lead.
2. Push the electric button START. Apply the rear brake lever to make sure the rear wheels are locked. If the ignition system is operating properly, a blue spark should jump across the spark plug gap. If there is no spark, take your machine to your service center.



WARNING

Performing the spark test improperly could be hazardous.

You could get a high voltage electrical shock if you are not familiar with this procedure.

Do not perform this check if you are not familiar with the procedure. Do not point the spark plug near the spark plug hole during this test. Do not do this test if you have a heart condition or wear a pacemaker. Do not perform this test is any near any open fuel containers for near fuel which has spilled on the ground, on the engine, or any part of the ATV.

COMPLAINT: Engine stalls

1. Make sure there is enough fuel in the fuel tank.
2. Check to see that the spark plug is not fouled. Remove the spark plug and clean it. Replace it, if necessary.
3. Make sure the fuel valve is not clogged, and the fuel tank is not clogged, either.
4. Check the idle speed. If necessary, adjust it using a tachometer. The correct idle speed is 1500 ± 150 r/min.

TRANSPORTING

Before transporting the ATV drain the fuel from the carburetor as follows:

1. Drain fuel from carburetor into an empty container by loosening the carburetor drain screw.
2. When the fuel has been drained. retighten the drain screw.

WARNING

Draining fuel from the carburetor could be hazardous.

Fuel could catch fire if you do not handle it properly.

When draining fuel from the carburetor, be sure to shut the engine off. Do not smoke, and never drain or refuel in an area where there are open flames or sparks. Do not spill the fuel or you may create a fire hazard. Dispose of the drained fuel properly.

▲ CAUTION

Failing to secure the ATV properly could be hazardous.

Failing to secure the vehicle properly may result in an accident or damage to the vehicle.

When transporting the ATV, lock the parking brake lever and tie down the vehicle securely with straps, rope, or some other suitable means. Use extra tie downs when you transport the vehicle in the standing position.

CLEANING PROCEDURE

A thorough cleaning of your ATV is a necessary part of maintenance. It will help keep your ATV looking and performing best. Proper cleaning can also extend the life of your ATV.

It is important to clean and inspect your ATV after every ride, especially if it is used in mud, brush, grass, water, salt water, or very dusty conditions

The build-up of mud, brush, grass, etc. especially on the engine and exhaust system, can reduce engine cooling ability, conceal damage, or increase wear of certain parts. It is important to remove all debris during cleaning.

PREPARATION FOR CLEANING

Wash the ATV before any mud dries on the ATV.

Block or seal the end of the exhaust pipe (muffler) using a piece of plastic wrap, cloth rag or another method to prevent water from entering engine.

▲ CAUTION

High pressure washers could damage your ATV.

High pressure washers such as those found at coin-operated car washes have enough pressure to damage the parts of your ATV. It may cause rust, corrosion and increase wear.

Do not use high pressure washers to clean your ATV.

WASHING YOUR ATV

With some care, your ATV can be washed in a similar manner to washing an automobile.

Note: Avoid spraying or allowing water to flow over the following places:

- Ignition
- switch · Spark
- plug · Fuel tank
- cap · Carburetor

Use a garden hose at low pressure to remove the majority of dirt or other debris. Hand wash your ATV with mild soap or detergent and water. Try to thoroughly remove all dirt and debris without excessive water pressure, even at remote areas such as between engine cooling fins, linkages or mounting brackets. Cloth rags, washing mitts or cleaning brushes can be used. Be careful with brushes as they may scratch plastic or painted surfaces. Rinse the ATV thoroughly with clean water. Dry all areas using a chamois or soft absorbent cloth.

INSPECTION AFTER CLEANING

Remove the rags or wrapping from the exhaust pipe. For extended life of your ATV, lubricate according to **GENERAL LUBRICATION** section.

Follow the procedures in the **INSPECTION BEFORE RIDING** section to check your ATV for any problems that may have occurred during your last ride.

▲ WARNING

Operating the ATV with wet brakes could be hazardous.

Wet brakes may not provide as much stopping power as dry brakes. This could lead to an accident.

Test your brakes after washing the ATV, riding at a slow speed. If necessary, apply brake several times to let the friction dry out the linings.

STORAGE PROCEDURE

If you do not use your ATV for a long time, it will need special service requiring appropriate materials, equipment and skill. For this reason, we recommend that you trust this maintenance work to your authorized service center. If you wish to service the machine for storage yourself, follow the general guidelines below:

VEHICLE

Place the vehicle on level ground and wash the entire vehicle.

FUEL

Drain the fuel from the fuel tank by a hand pump. Drain the fuel from the carburetor by releasing the carburetor drain screw.

▲ WARNING

Draining the fuel could be hazardous.

Fuel could catch fire if you do not handle it properly.

When draining the fuel from the fuel tank, be sure to shut the engine off. Do not smoke, and never drain fuel in an area where there are open flames or sparks. Keep pets and children away from the fuel, and dispose of the drained fuel properly.

TIRES

Inflate tires to the normal pressure.

EXTERNAL

1. Spray all vinyl and rubber parts with rubber protection.
2. Spray unpainted surfaces with rust preventative.
3. Coat painted surfaces with car wax.

PROCEDURE FOR RETURNING TO SERVICE

1. Clean the entire vehicle.
2. Make sure that the vehicle is properly lubricated.
3. Perform the INSPECTION BEFORE RIDING as listed in this manual.
4. Start the vehicle as outlined in this manual.

SPECIFICATIONS

RPS 125CC ATV	
Drive	2WD
Suspension Front	Double swing arms
Suspension Rear	Swing arm
Brakes Front	Double Drums
Brakes Rear	Hydraulic Disc
Tire Front	AT19 × 7 - 8/10 psi
Tire Rear	AT18× 9.5 - 8/5 psi
Overall Dimensions (L ×W ×H)	1510 mm× 945mm× 940mm
Seat Height	740mm
Ground Clearance	90mm
Wheelbase	935mm
Dry Weight	104kg
Fuel Capacity	2L
Combustion Cycle	4
Number of Cylinder	1
Bore × Stroke (mm)	52.4mm × 55.5mm
Piston Displacement	125 cc
Compression Ratio	9.1:1

Starter System	Electric
Type of carburetor	PZ20
Lubrication	Press Splash
Cooling	Air cooled
Ignition Type	C.D.I
Generator	Magneto
Clutch	Automatic
Transmission	Automatic

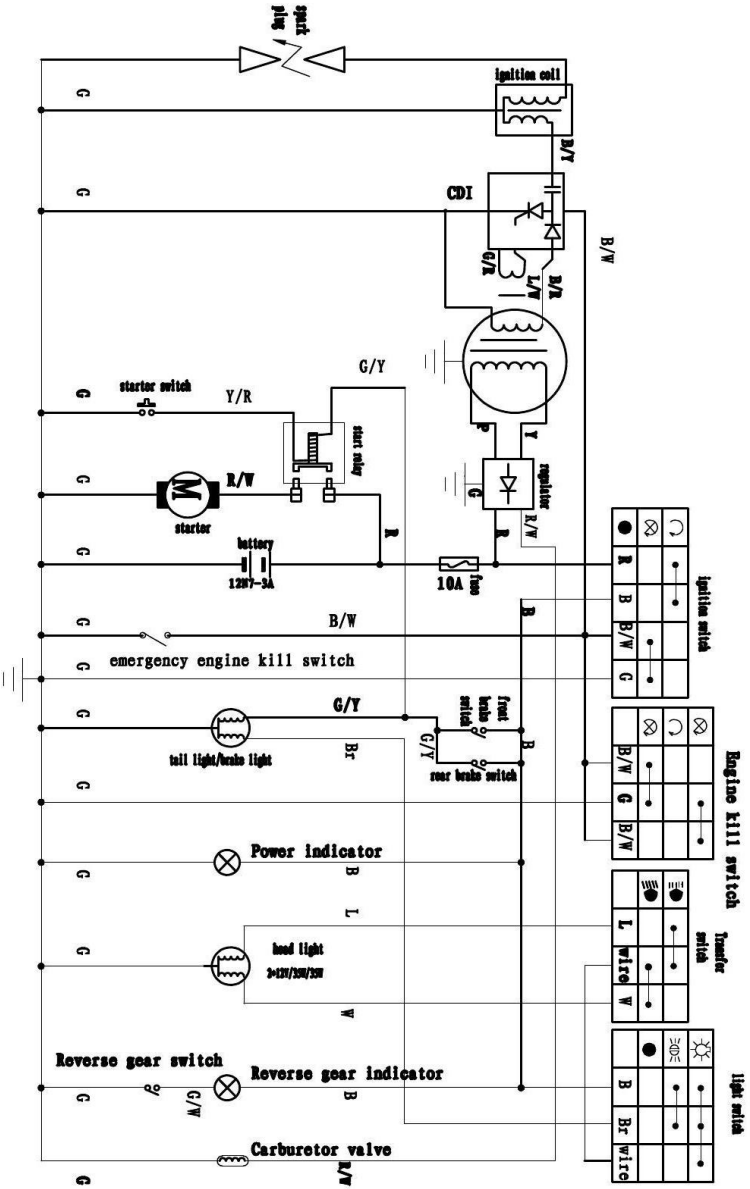

Ricky Power Sports, LLC.

EMISSION CONTROL SYSTEM WARRANTY

YOUR WARRANTY RIGHTS AND OBLIGATIONS

The emission control system warranty period for this vehicle begins on the date the vehicle is delivered to the first purchaser other than an authorized dealer, or the date it is first used as a demonstrator, lease, or company vehicle, whichever comes first and continues for 30 months after that date, or 5,000km, whichever comes first, provided there has been no abuse, neglect or improper maintenance of your vehicle. Where a warrantable condition exists, Ricky Power Sports, LLC will repair your vehicle at no cost to you, including diagnosis, parts and labor. If an emission-related part on your vehicle is defective, the part will be repaired or replaced by the Ricky Power Sports, LLC. This is your emission control defects warranty.

OWNER'S WARRANTY RESPONSIBILITIES

As the vehicle owner, you are responsible for the performance of the required maintenance. You should maintain a record of all maintenance performed on your vehicle and retain all receipts covering maintenance on your vehicle. You may not be denied a warranty claim solely because of your failure to ensure the performance of all scheduled maintenance or lack of maintenance records or receipts. You are responsible for presenting your vehicle to an authorized dealer as soon as a problem exists. The warranty repairs should be completed in a reasonable amount of time, not to exceed 30 days.

As the vehicle owner, you should be aware that you may be denied your warranty coverage if your vehicle or a part has failed due to abuse, neglect, improper maintenance, or unapproved modifications.

WARRANTY COVERAGE

Ricky Power Sports, LLC warrants that each new 2021 and later vehicle:

- is designed, built, and equipped so as to conform at the time of initial retail purchase with all applicable regulations of the United States Environmental Protection Agency; and
- is free from defects in material and workmanship which cause such vehicle to fail to conform with applicable regulations of the United States Environmental Protection Agency for the periods specified above.

Your emission control system warranty covers components whose failure would increase an engine's emission, including electronic controls, fuel injection system, carburetor, the ignition system, catalytic converter, or any other system utilized in this vehicle to control emission if it is originally equipped. Also included may be hoses, connectors and other emission-related assemblies. Replacing or repairing other components (including parts, labor, and other costs) not covered by this emission control system warranty or the standard warranty is the responsibility of the owner.

Coverage of repairs under this warranty applies only when repairs are completed at an authorized dealer or repair facility. Ricky Power Sports, LLC will not cover repairs performed outside of an authorized dealer or repair facility. The use of replacement parts not equivalent to the original parts may impair the effectiveness of your vehicle's emission control system. If such a replacement part is used and an authorized dealer determines it is defective or causes a failure of a warranted part, your claim for repair to bring your vehicle into compliance with applicable standards may be denied. This Emission Control System Warranty is in addition to the standard Limited Warranty.

EXCLUSIONS AND LIMITATIONS

This warranty does not cover the following:

- Failures or malfunctions of the emission control systems caused by abuse, alteration, accident, misuse, the use of leaded gasoline.
- Replacement of expendable maintenance items unless they are original equipment defective in material or workmanship under normal use, and the first required replacement interval for the item has not been reached. Expendable maintenance items include but not limited to spark plugs, filters, coolant, lubricants, gaskets, hoses, and belts.
- Replacements of parts and other services and adjustments for required maintenance.
- Any vehicle equipped with an odometer or hour meter where the reading is altered so that actual mileage cannot be readily determined.
- Repairs or replacements as a result of:
 - o Accident
 - o Misuse
 - o Use of replacement parts or accessories not conforming to the original specifications which adversely affect performance
- Physical damage, corrosion, or defects caused by fire, explosions or similar causes beyond the control of the Distributor.
- Failures not caused by a defect in material or workmanship.

Use of the vehicle in any type of competitive racing or related events immediately and completely voids this and all other warranties.

LIMITED LIABILITY

The liability of Ricky Power Sports, LLC under this Emission Control System Warranty is limited solely to the remedying of defects in material workmanship by an authorized dealer at its place of business during customary business hours. This warranty does not cover inconvenience or loss of use of the vehicle or transportation of the vehicle to/from the authorized dealer. Ricky Power Sports, LLC is not liable to any person for incidental, consequential or special damages of any description, whether arising out of express or implied warranty or any other contract, negligence or other tort or otherwise.

No express emission control system warranty is given by Ricky Power Sports, LLC except as specifically set forth herein. Any emission control system warranty implied by law,

including any warranty of merchantability or fitness for a particular purpose is limited to the express emission control system warranty terms stated in this warranty. The foregoing statements of warranty are exclusive and in lieu of all other remedies. All express warranties not stated in this warranty are disclaimed. Some states do not allow limitations on how long an implied warranty lasts, so the above limitations may not apply if it is inconsistent with the controlling state law.

No dealer is authorized to modify this Emission Control System Warranty. If you have any questions regarding your warranty rights and responsibilities, you should contact Ricky Power Sports, LLC(+1 844-250-2199).



Ricky Power Sports, LLC.

**2425 Camp Ave.#100,
Carrollton, TX75006**

Toll Free: 844-250-2199