

**ARIEL**

500 West Warner Avenue, Santa Ana, CA

ArielBath.com | AtlasUSA.net

Email: sales@arelbath.com | Phone: 1-714-622-1565

**ARIEL**

**DZ972F8 Installation Instruction**

## **CONTENTS**

- 01-02 Components instruction
- 03 Diagram for water and electricity
- 03-14 Installation steps
- 15-16 Control panel and function instruction
- 17 Dirt cleaning equipment instruction
- 18-19 Service card
- 20 Troubleshooting instruction

Installation Instruction

## Important safety information

1. Please read and follow this instruction
2. Power supply should be in accordance with local standard of leakage protector. Please test leakage protector before using product.
3. Ground wire of product should be connected to fixed ground wire permanently.
4. 1.To avoid electric shock, please don't use extension line to connect power supply, and choose suitable place to install socket. Please replace broken electric wire in time. Please ask professional electrician to operate electric wire installation and replacement.
5. Please don't use this product after alcohol or drugs.
6. The children should be closely supervised by parents.
7. 1.Warning: the water temperature shall never exceed 60°C (140°F) when using this product.
8. Don't use strong causticity chemical liquid to clean product, such as sulphuric acid, hydrochloric acid, lye and etc.
9. The powers of steam generator are 3KW, 4.5KW and 6KW. Please use less than 2.5 square millimeter, 4 square millimeters and 6 square millimeter copper wire respectively as electric wire.
10. No humidifier is allowed in steam house.
11. Warning: please don't screw cleaning box to avoid being hurt by steam.

## Installation wiring diagram

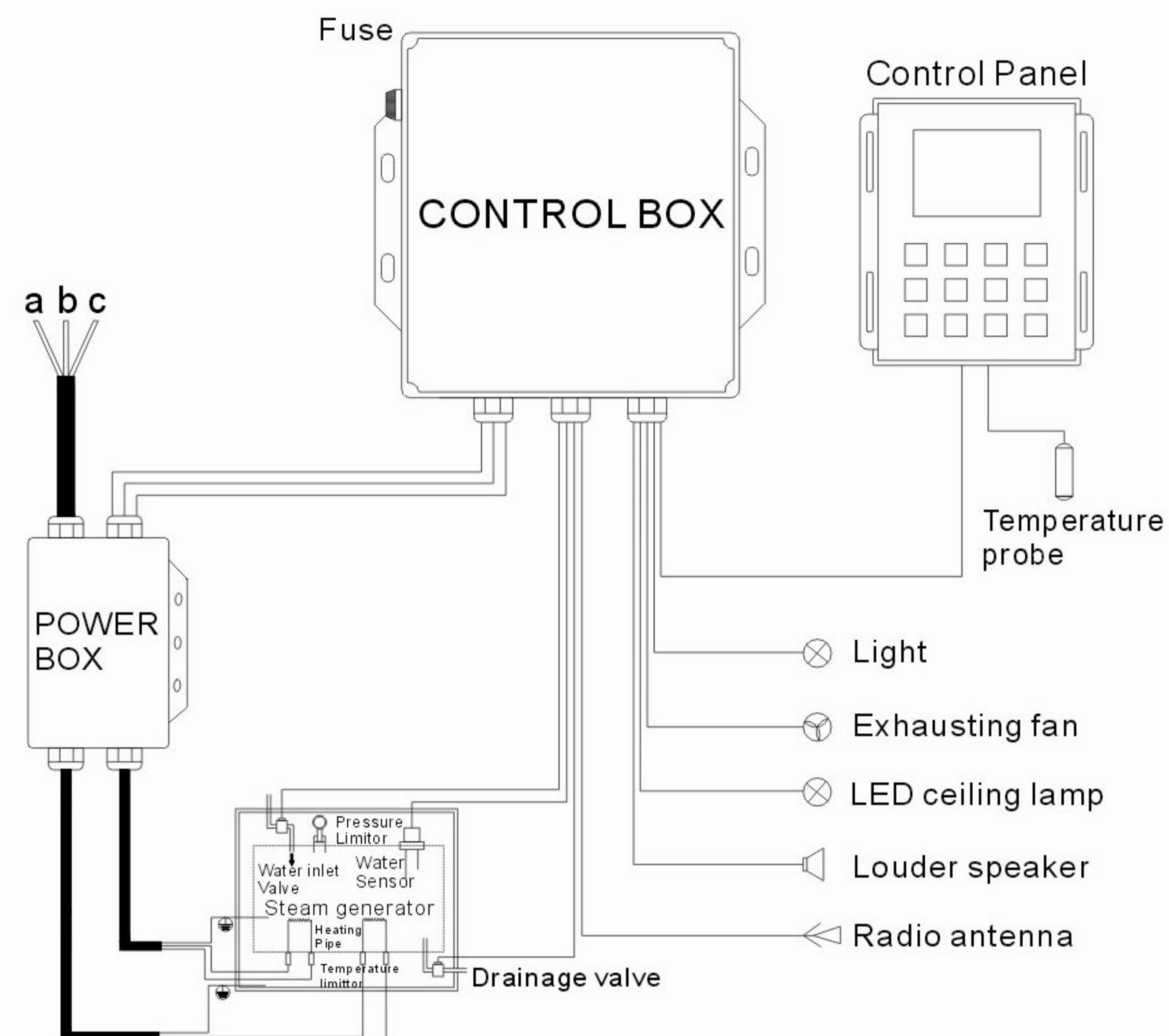







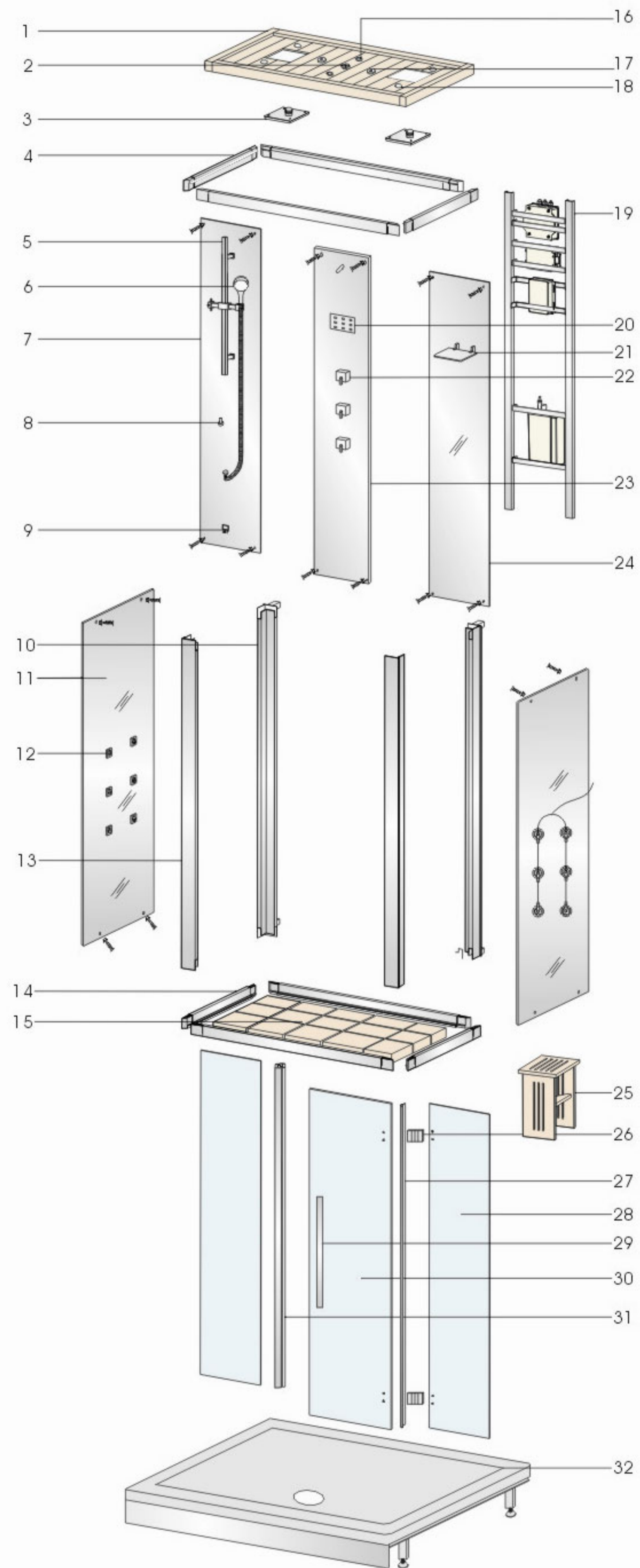





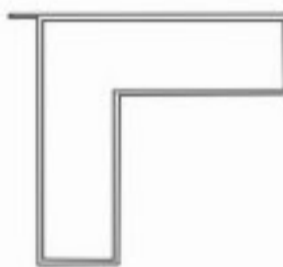

## Electrical parts specification

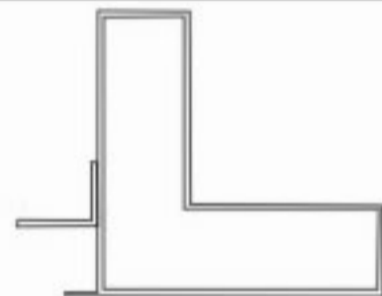
Configuration Parameter	massage pump	steam generator	LED ceiling lamp	exhausting fan	Solenoid valves	CPU	Speaker	Note
Rating voltage		AC220-240V/50HZ	DC12V	DC12V	DC12V	AC220V-240V/ 50HZ		
Rating voltage		AC240V/60HZ	DC12V	DC12V	DC12V	AC240V/60HZ		
Rating power		3000W	10W	3W	5W		10W	
Rating power		4500W	10W	3W	5W		10W	
Rating power		6000W	10W	3W	5W		10W	





# Parts instruction





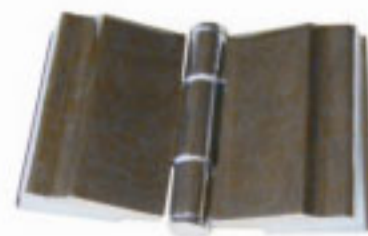



1.Top cover	2.Exhausting fan	3.H-2065 top shower	4.Upper fixed aluminum profile
			
5.Quadrate lifting support	6.Shower head	7.Left back panel	8.Generator cleaning inlet
			
9.Quadrate steam outlet	10.Comer aluminum profile (back)	11.Side panel	12.Quadrate jet
			
13.Comer aluminum profile (front)	14.Lower fixed aluminum profile	15.Bottom pallet	16.Light
			
17.Speaker	18.LED ceiling lamp	19.Fixed frame	20.Control panel
			
21.Supporter	22.Faucet and deviator	23.Middleback panel	24.Right back panel
			

# Parts instruction

## Parts package

25. Stool	26. Clip	27. Waterproof seal
		
28. Front fixed glass	29. Handle (small)	30. Movable door
		
31. Magnetic stripe	32. Tray	
		

4x25 flat self locking screw 36pcs	4x20 flat self locking screw 16pcs
	
Colloidal particle 36pcs	Glass cement (black) 1 pc
	
2.5mm hexagon wrench 1pc	3 mm hexagon wrench 1pc
	
4mm hexagon wrench 1pc	Delting 10pcs
	

## Diagram for water and electricity

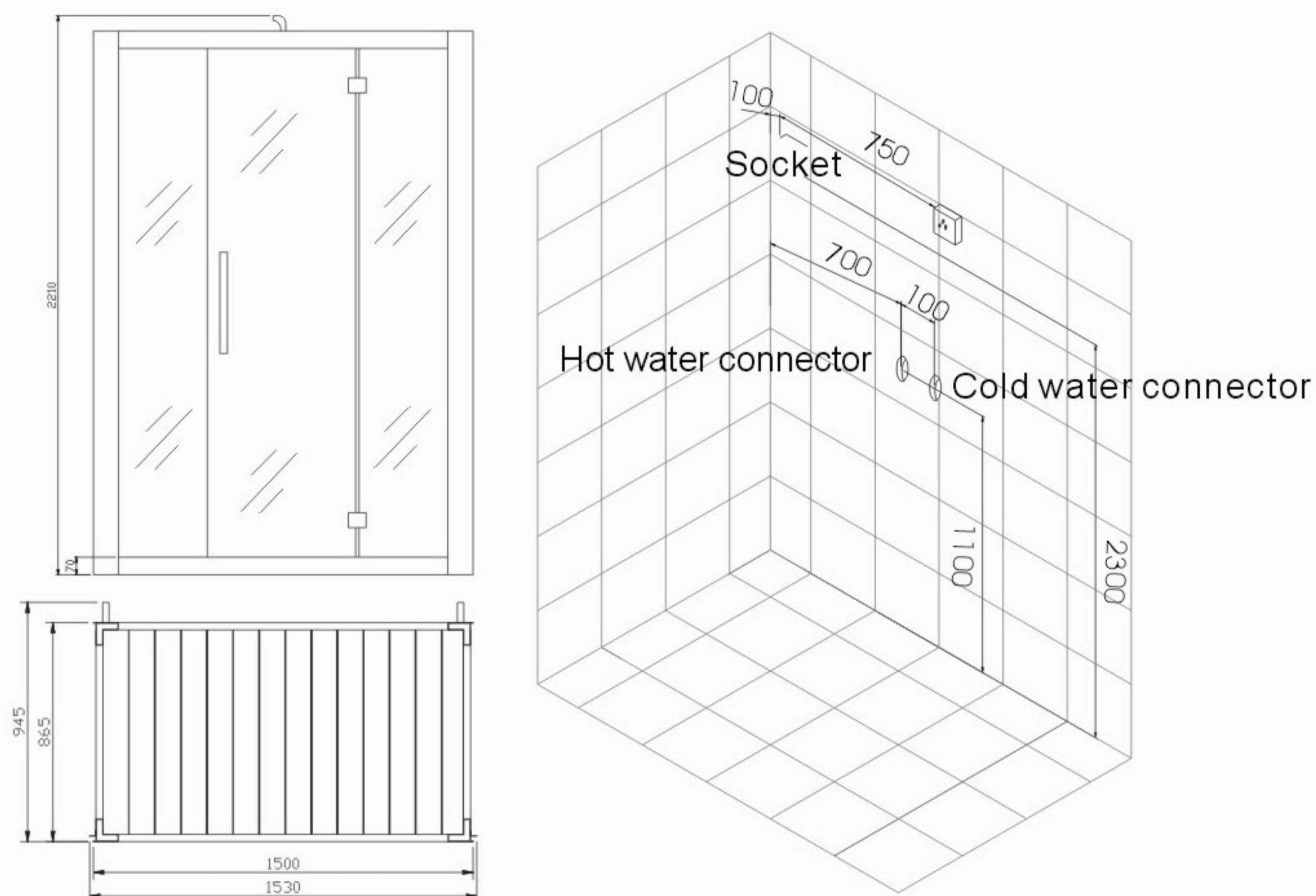

## Installation instruction 1

1. Put shower tray on installation place and adjust till it meets level condition.  
Method: put water level on the flat surface of shower tray to check if the shower tray is horizontal or not. If it is not horizontal, please adjust the height of adjustable leg to keep the product horizontal. Refer to picture A.
2. Put drainer on the bottom of shower tray, then connect little silicone tube to the top of drainer.

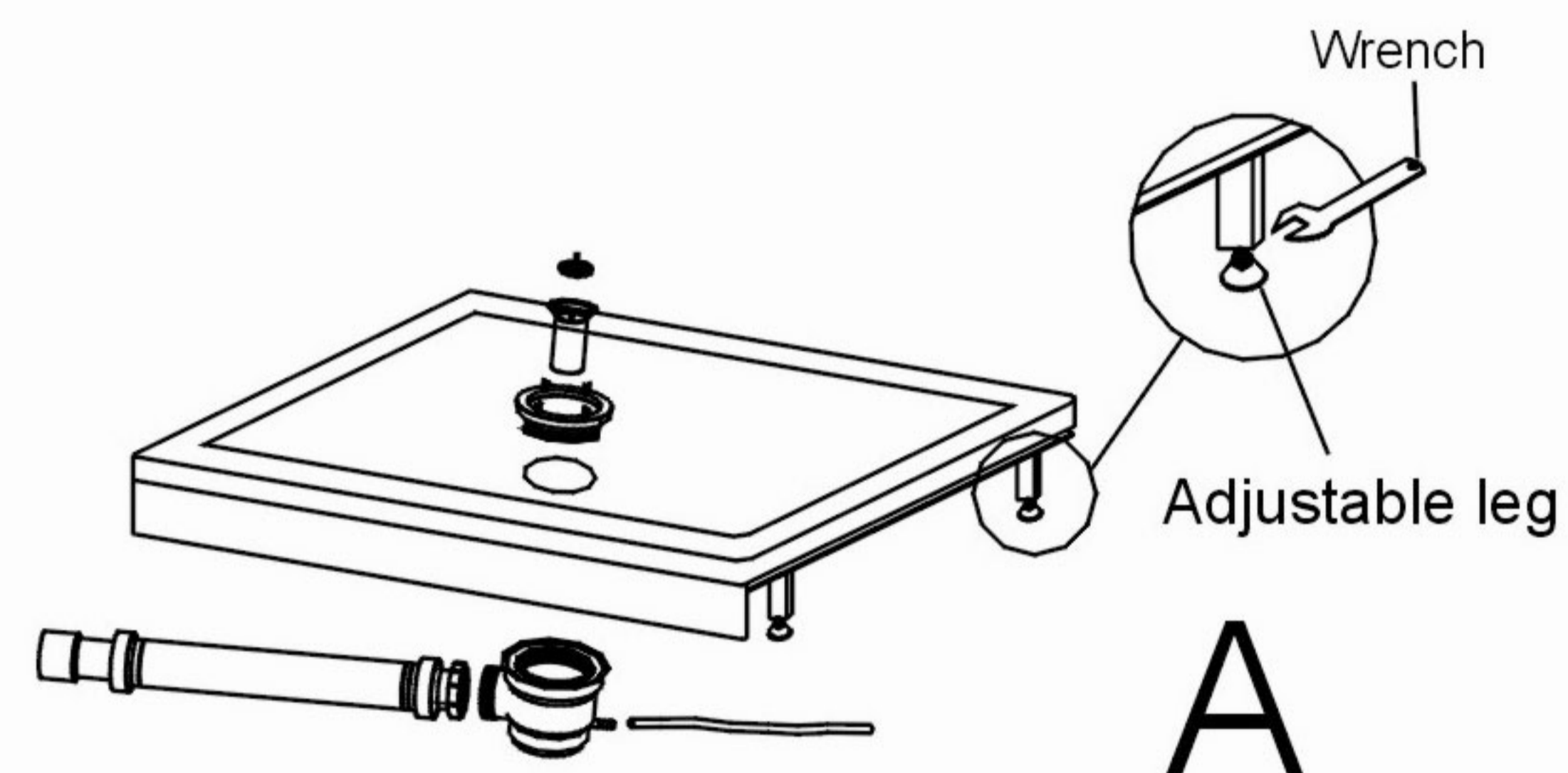

## Installation instruction 2

Put lower fixed aluminum profile 1 on the ground, then follow picture A to insert corner profiles in lower corner aluminum profile 1 with 4x20 self locking screw as picture B. Then fix upper fixed aluminum profile 2 to the corners profiles in the same way.

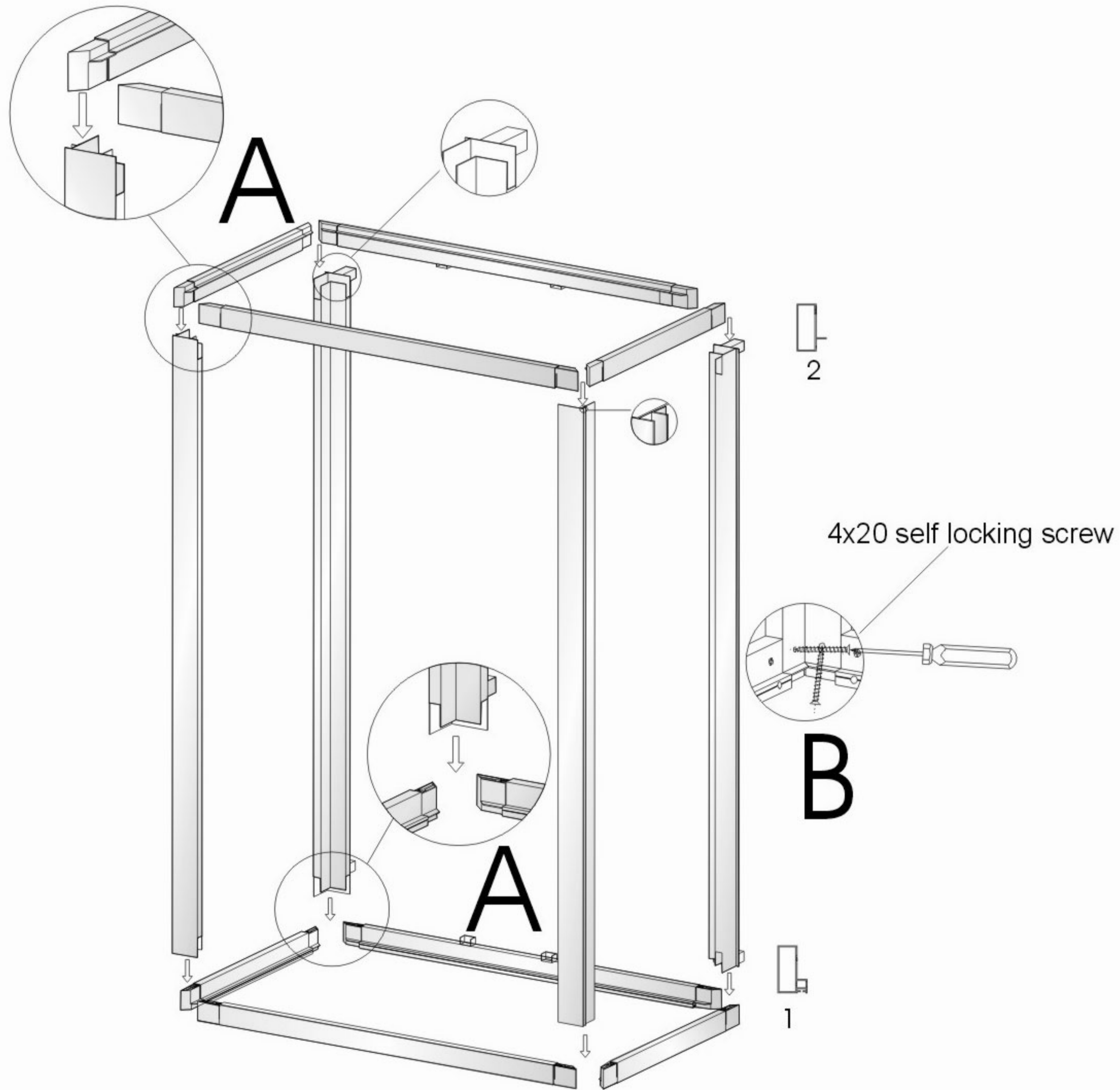

## Installation instruction 3

Follow picture 2 to screw 8 corners tightly with 4x20 flat self locking screw as picture A and B. Check and make sure the gap between of aluminum alloy matching surface is less than 0.5 as picture C.

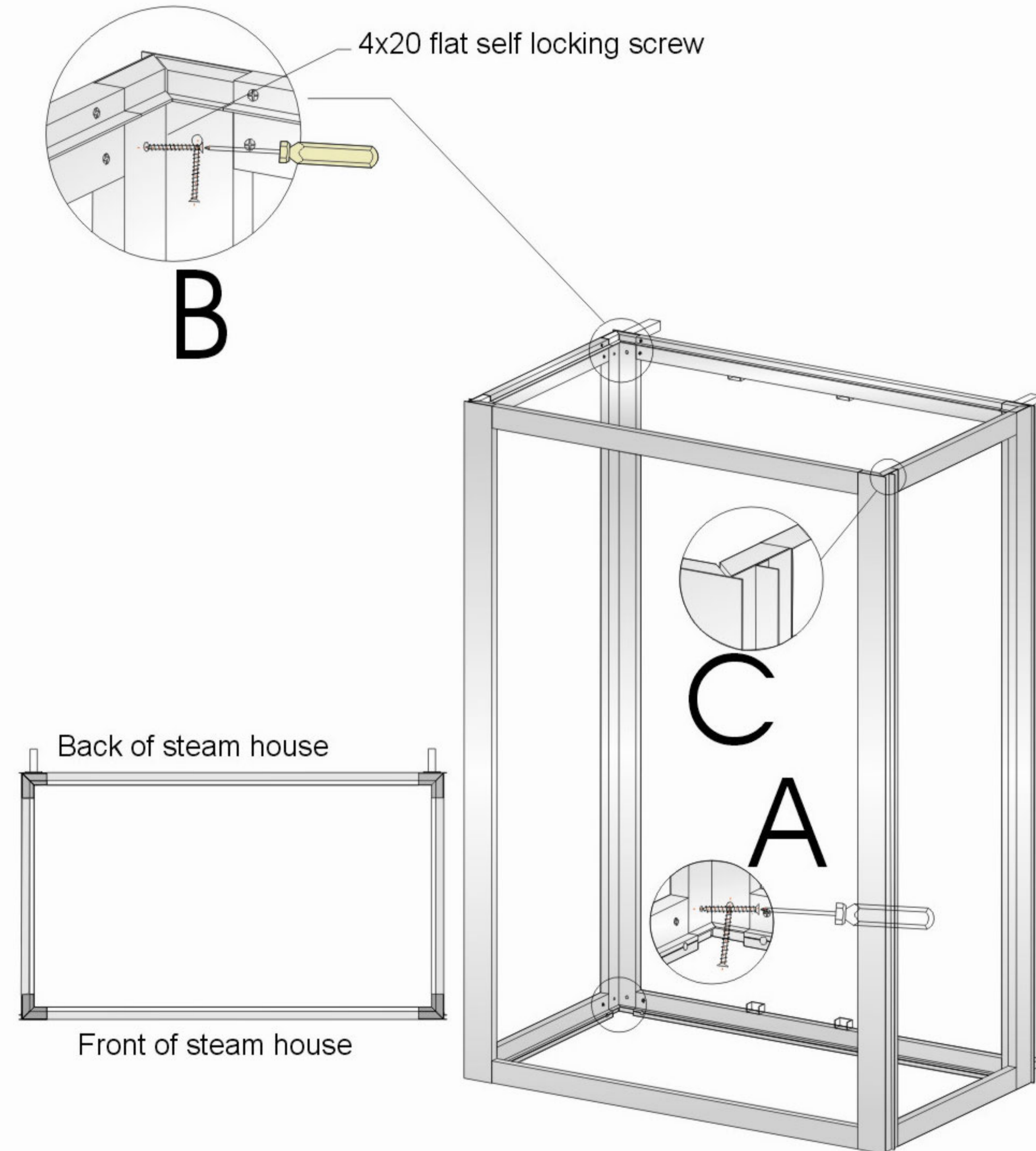

Insert and fix all electricity appliances into corresponding position. Gap tolerance is no more than 1mm.

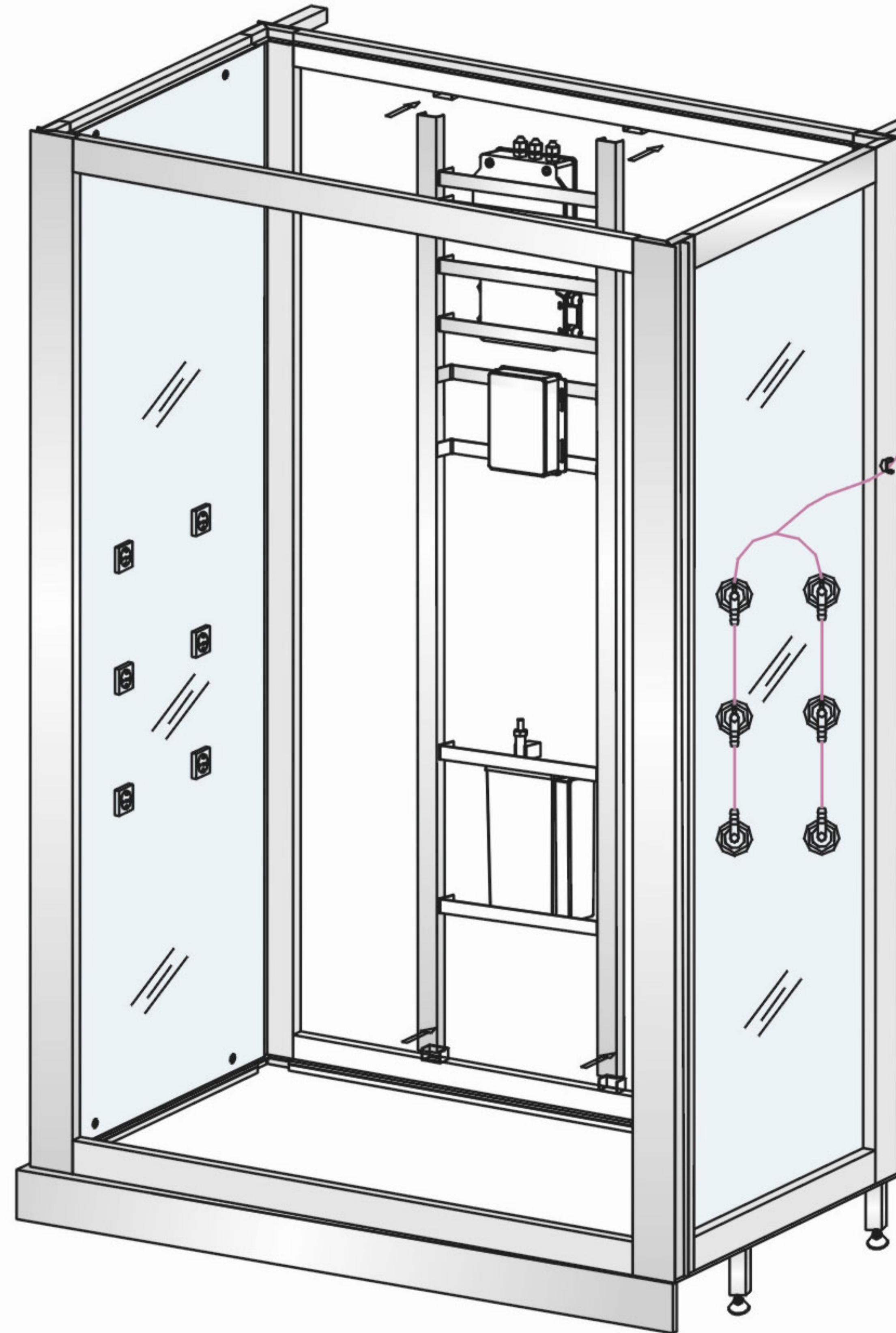



## Installation instruction 7

1. Put left and right back panels between corner aluminum profile and fixed frame with 4x25 flat self locking screw as picture A.
2. Install glass clip on the right shower panel as picture B, and fix glass and glass clip with screw as picture C.
3. Fix lifting support to left shower panel with 4x16 screws as picture D.
4. Link shower chain and shower connector as picture E.

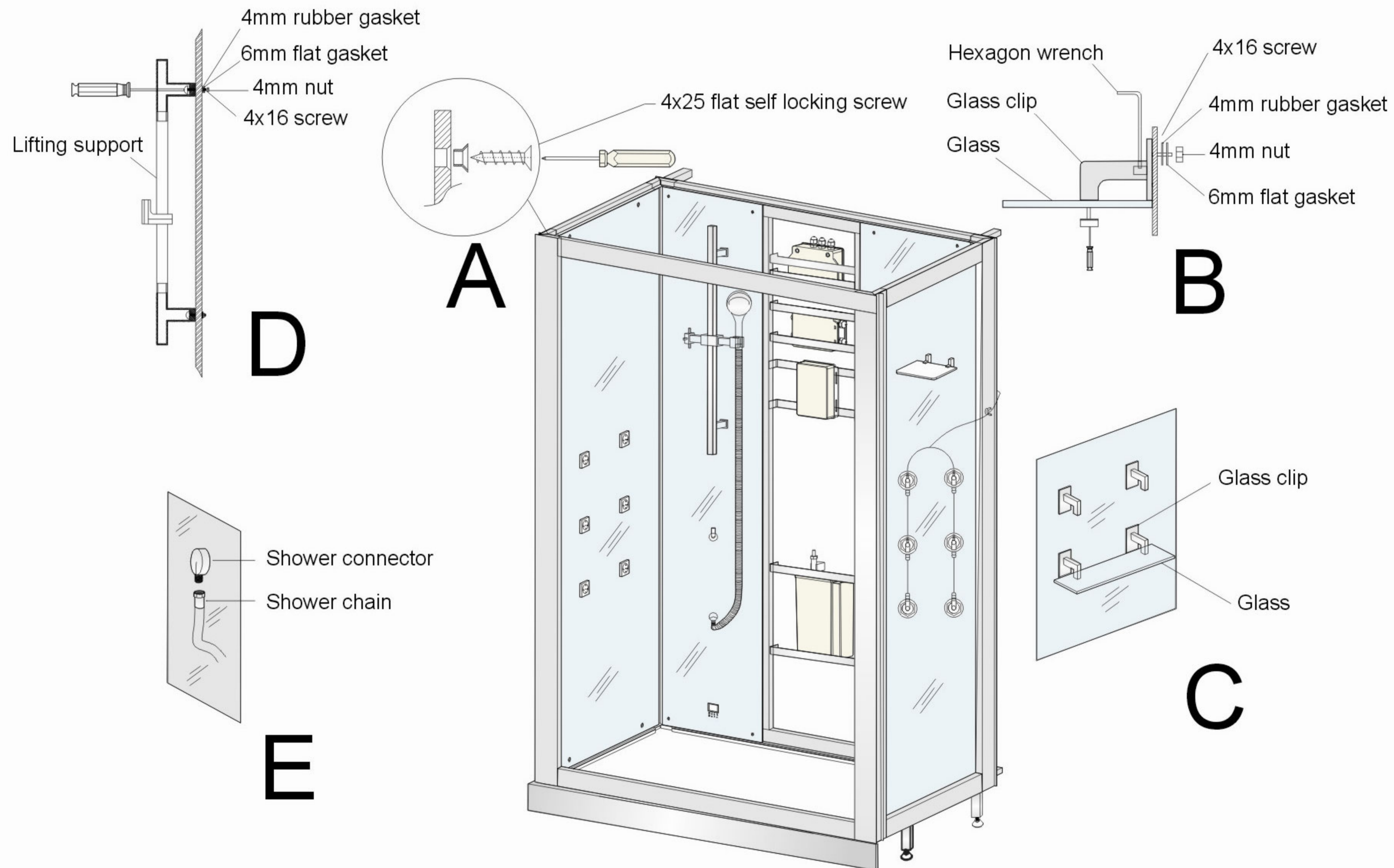

1. Put top cover on the top as picture A.
2. Connect ventilator and corresponding plug as directions.

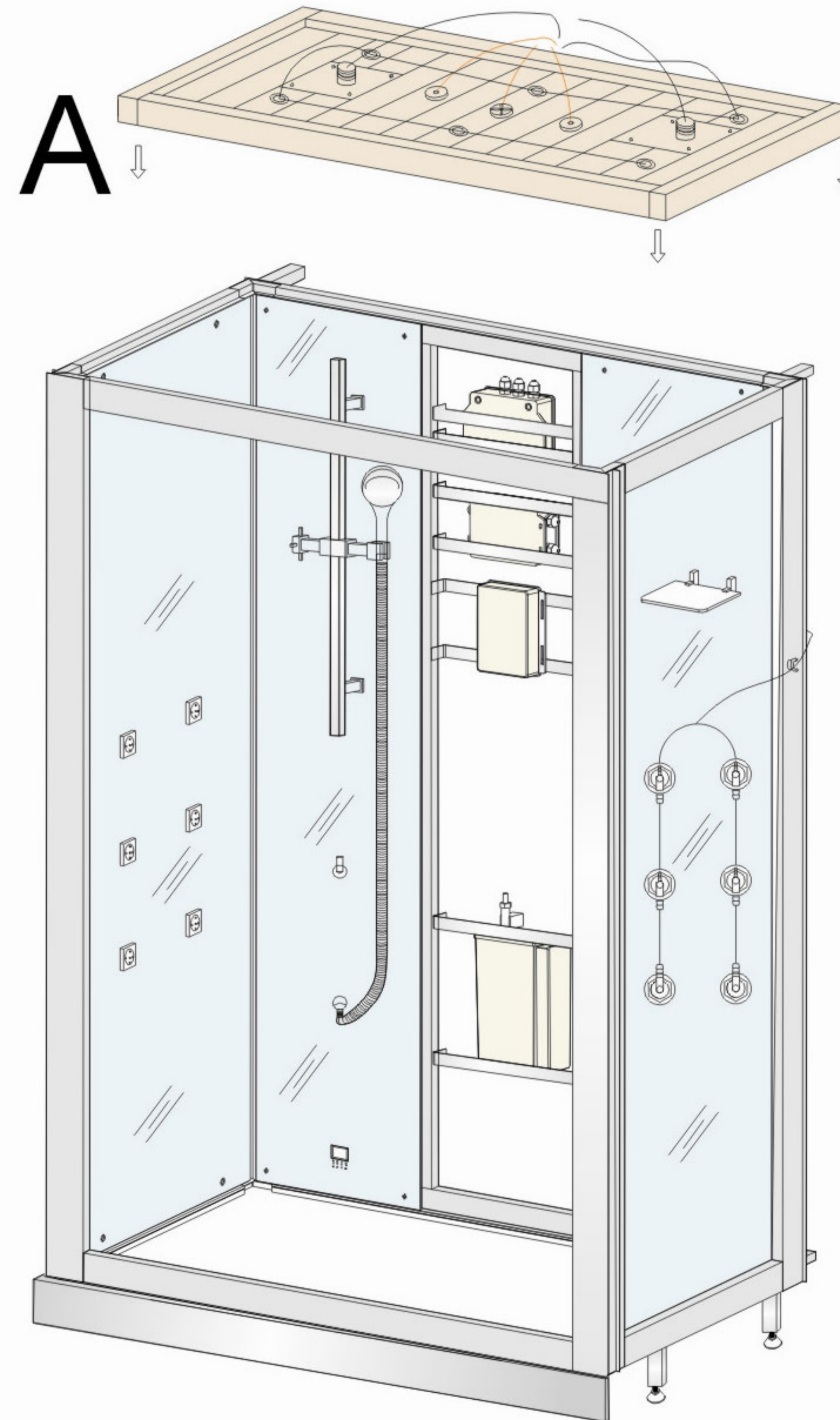

## Installation instruction 9

Install front fixed doors between corner aluminum profiles and upper&lower fixed aluminum profiles.  
Please note there is difference between left glass door and right glass door.  
Please check whether the product works well or not before going to the next steps.

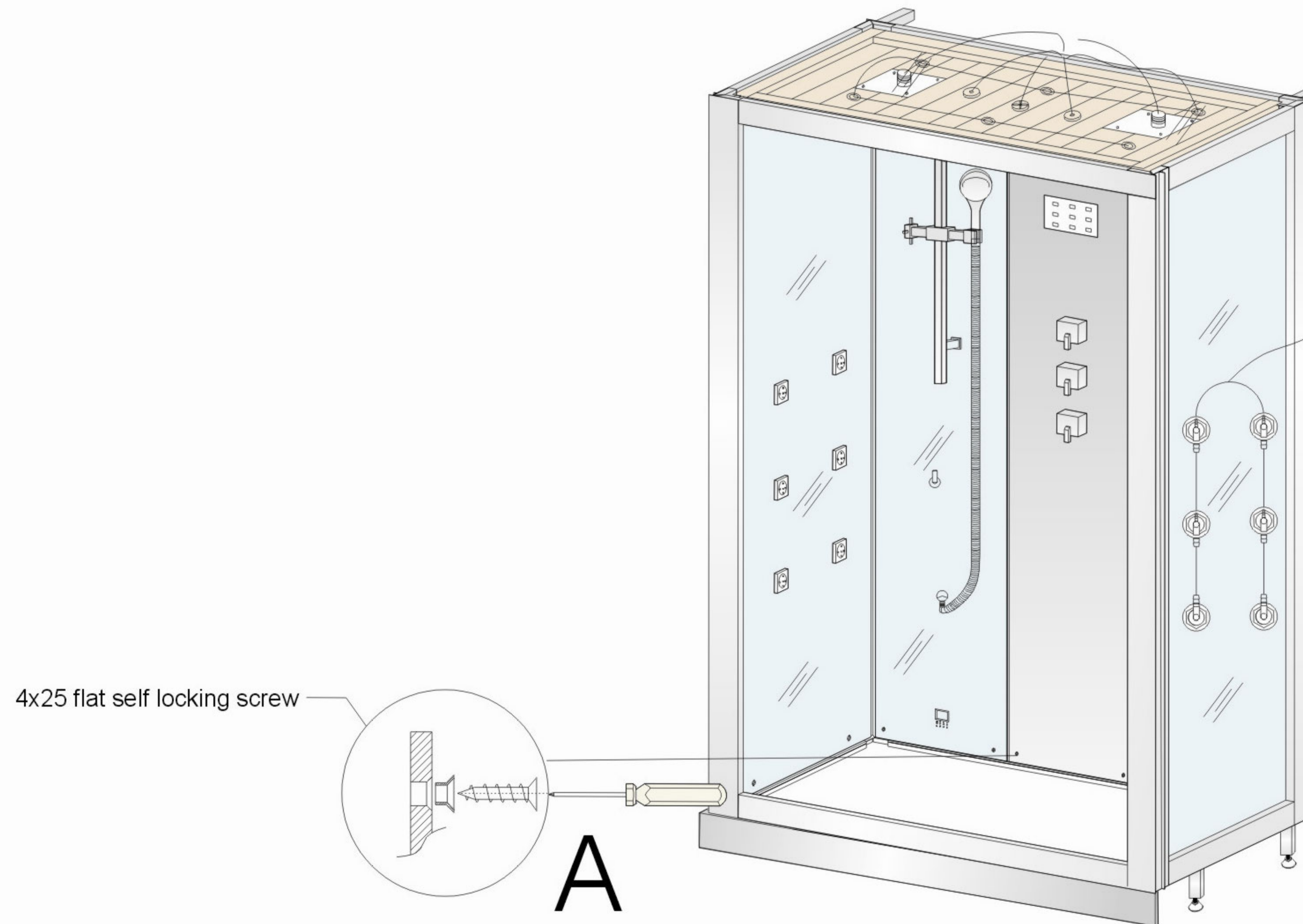

Connect all hoses on the middle back panels and fix the middle back panels to the upper&lower fixed aluminum profiles.  
Plesase double check whether it is right after you connect the hoses and electricity lines.

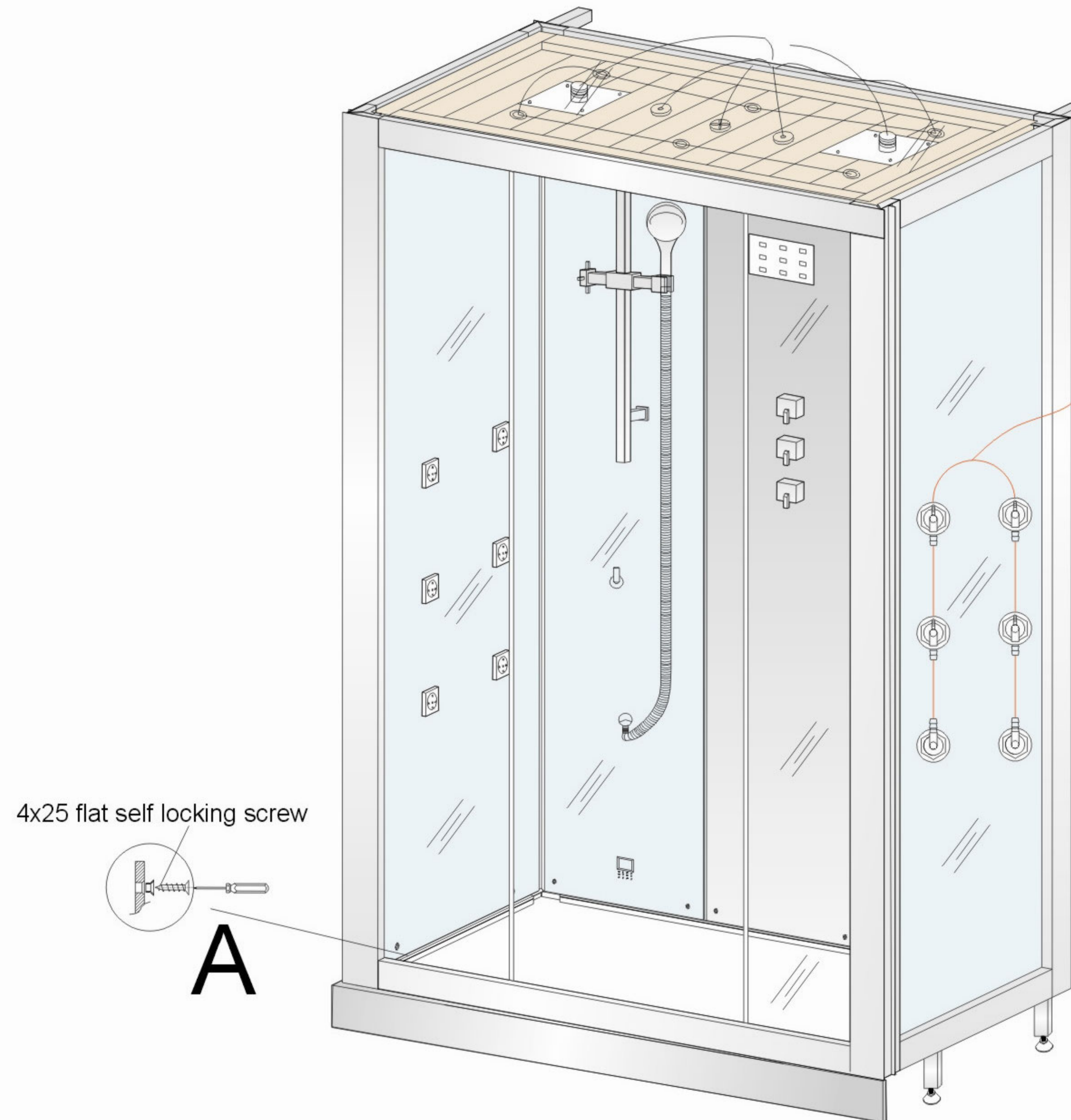

## Installation instruction 11

Apply glass cement in four corners of glass interfaces as picture A. Glass interfaces of back panel, please refer to picture B. Bottom interfaces, please refer to picture C. Dealing with trim after applying glass cement. It takes 24 hours to solidify.

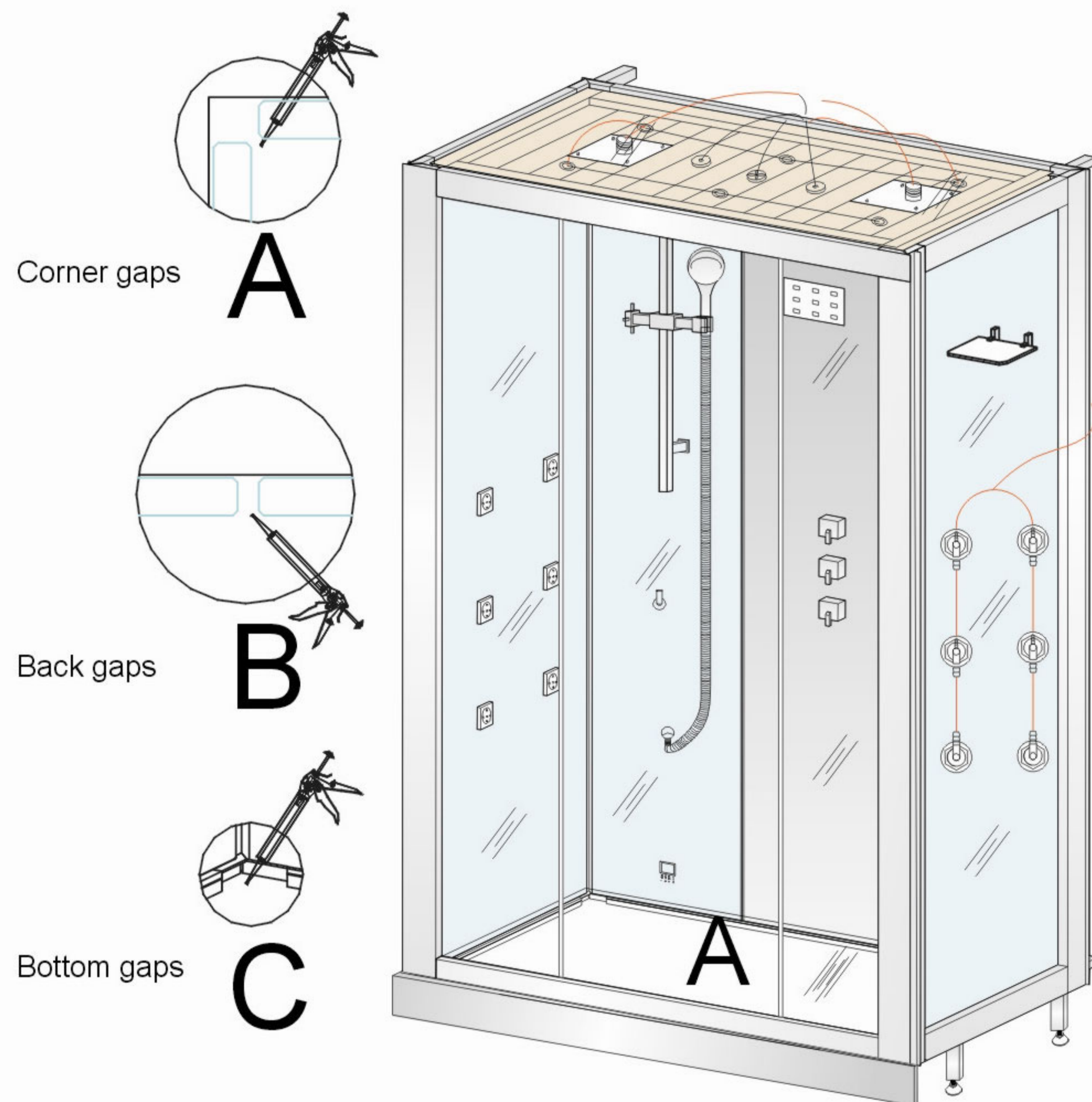

## Installation instruction 12

Assemble bottom pallet as picture A. Details as picture B.

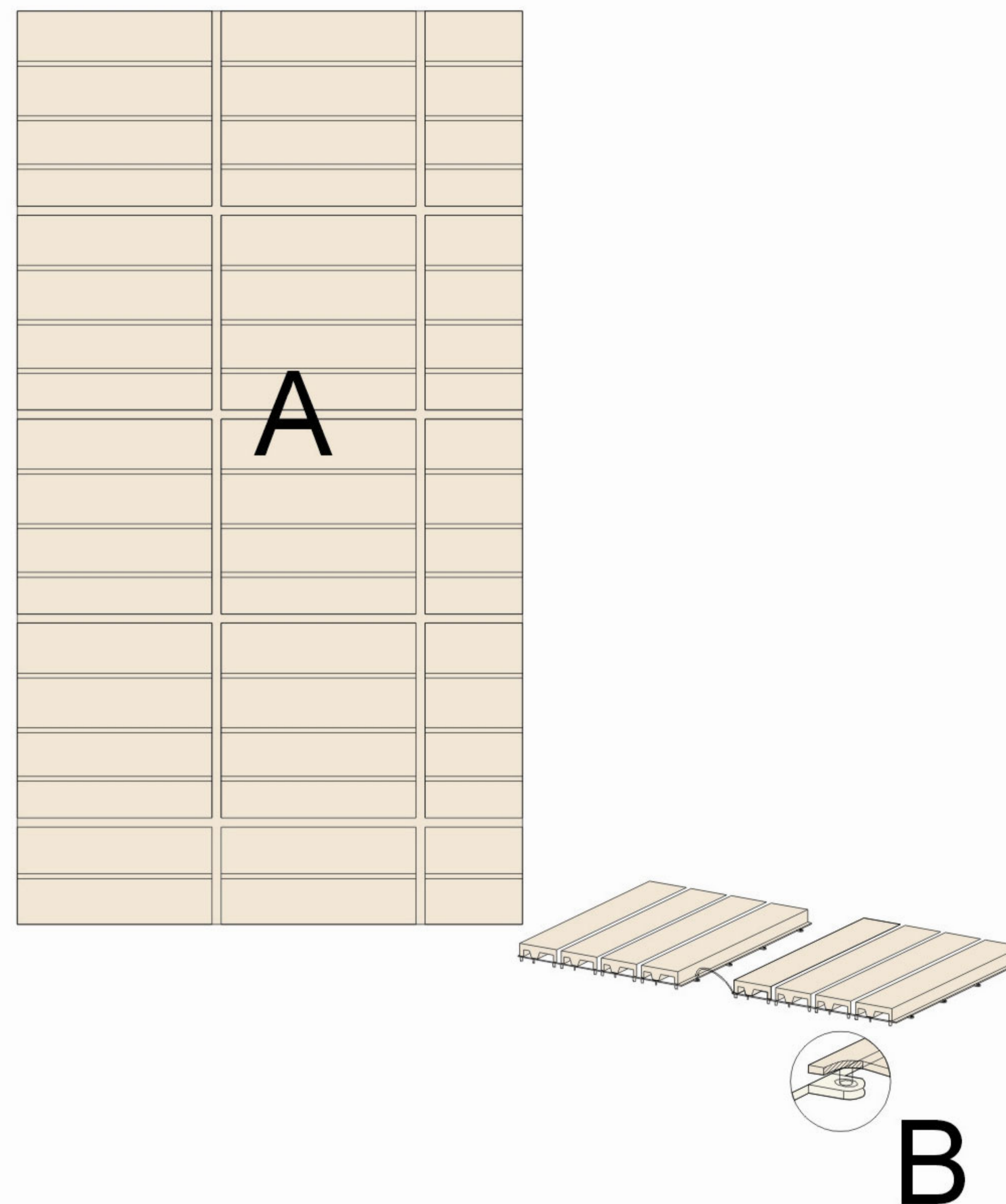

## Installation instruction 13

Put bottom pallet at corresponding position as picture A.

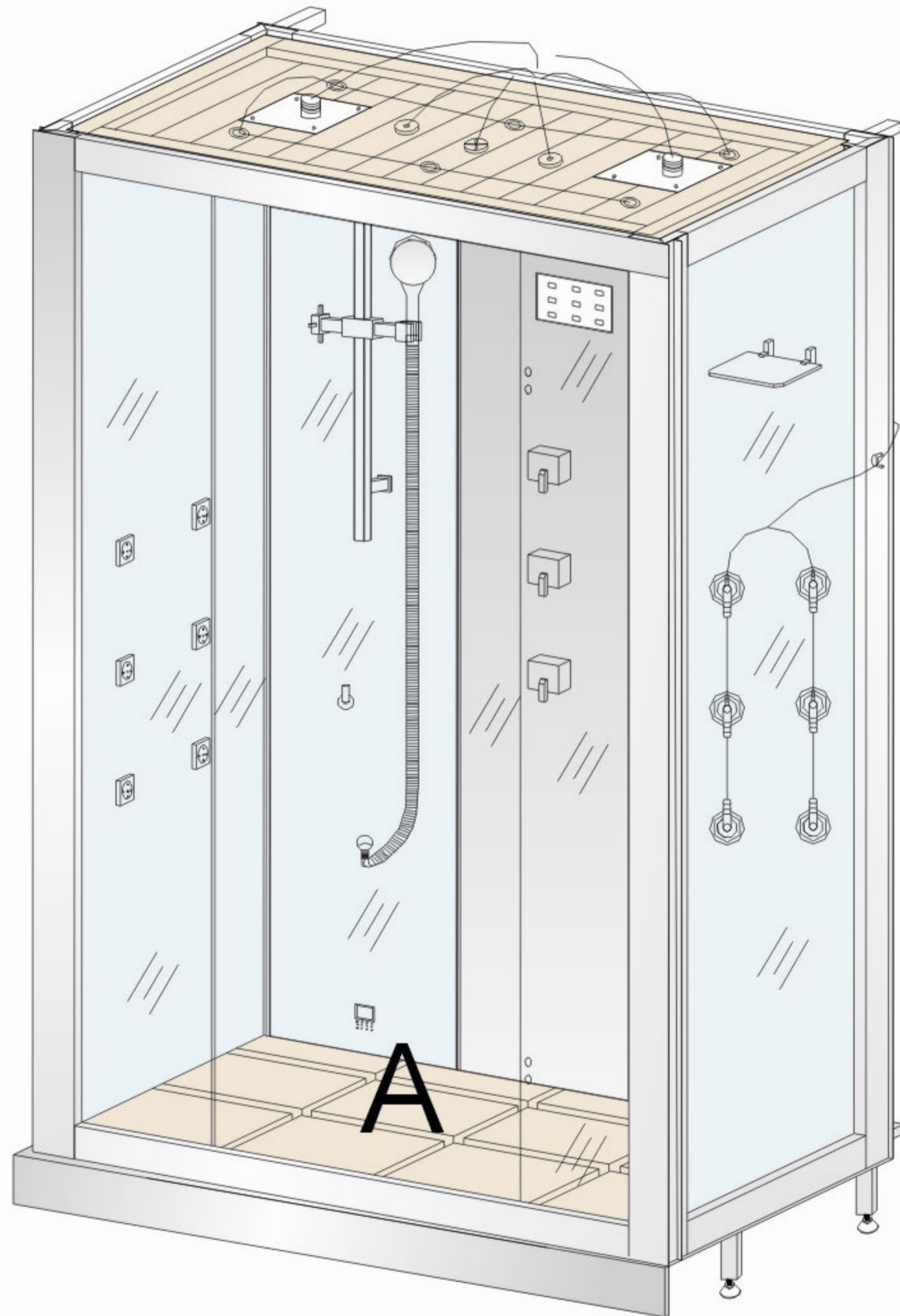

## Installation instruction 14

1. Connect movable door A and fixed door with clip. (If movable door can not be sealed, please use hexagon wrench to adjust clip as picture B)
2. Install handle in movable door with hexagon wrench as picture C.
3. Install waterproof seal D on the top of movable door.
4. Install waterproof seal E on the edge of movable door.
5. Install waterproof seal F on the bottom of movable door.
6. Install magnetic strip G on movable door and fixed door.

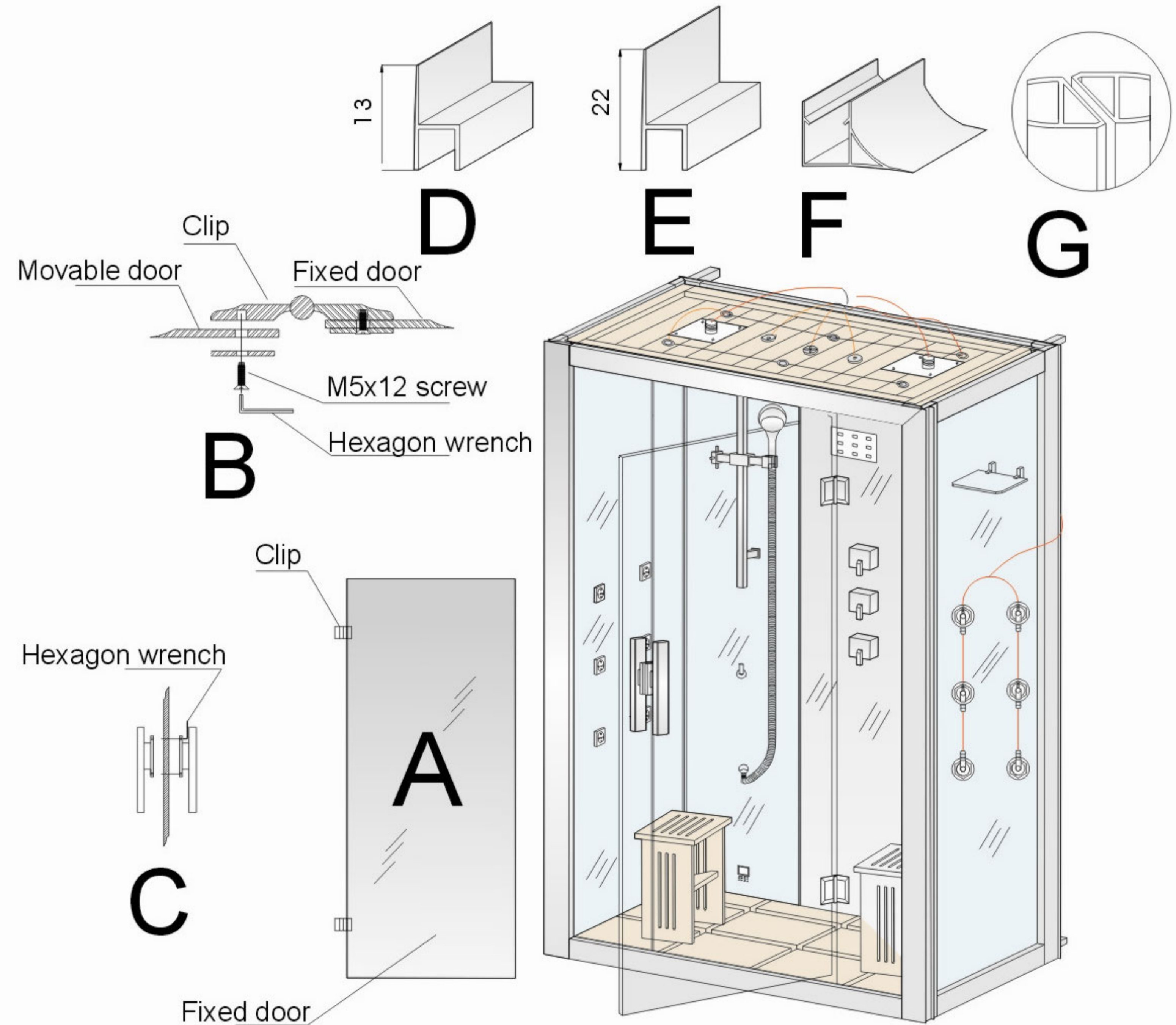

## Installation instruction 15

Look and fix the alumium profiles and tray by fixed iron stripe with the help 6x30 screws.

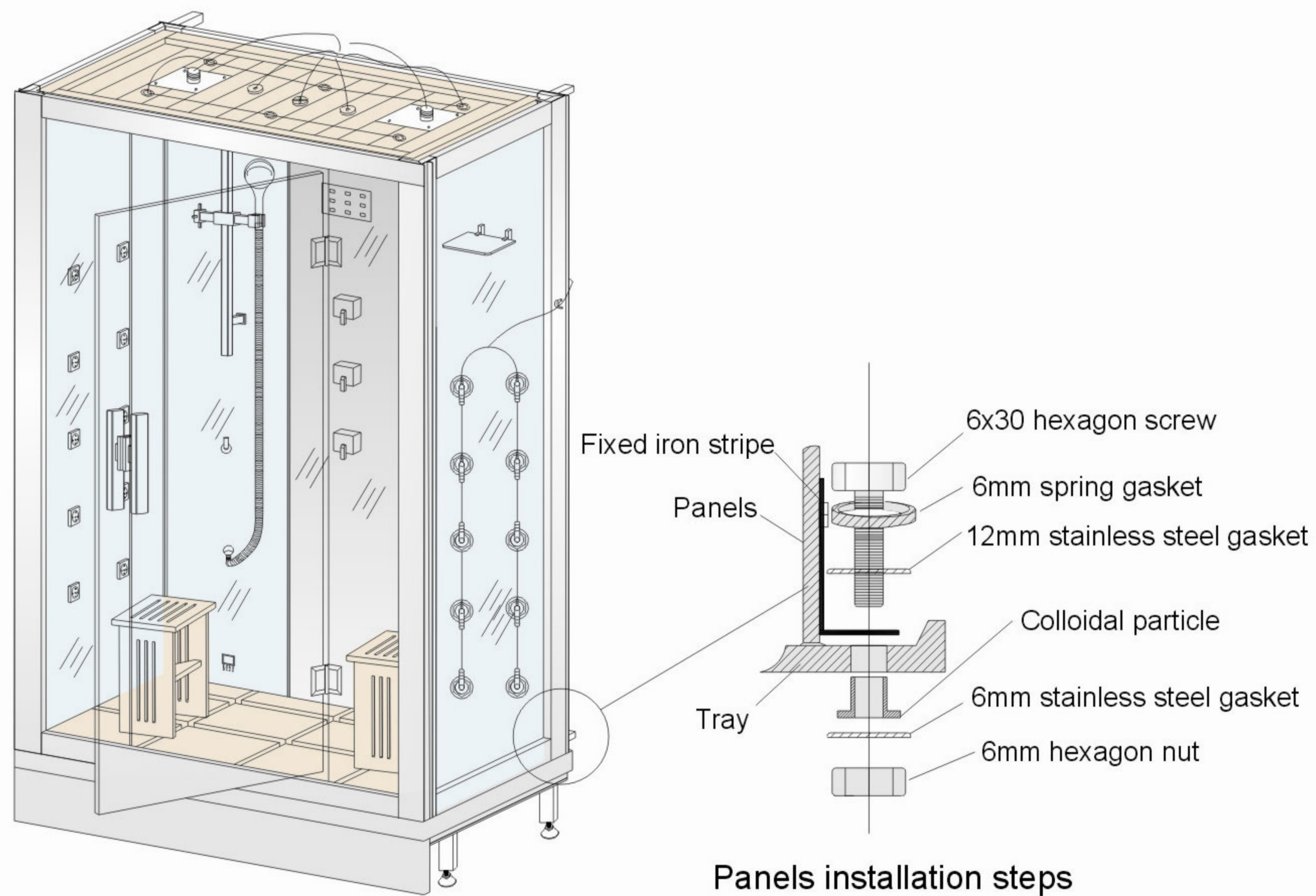

Install top shower tube, steam tube, steam drainage tube and cold&hot water pipes. Check and confirm whether functions of steam shower house, fittings and electric appliance work well.

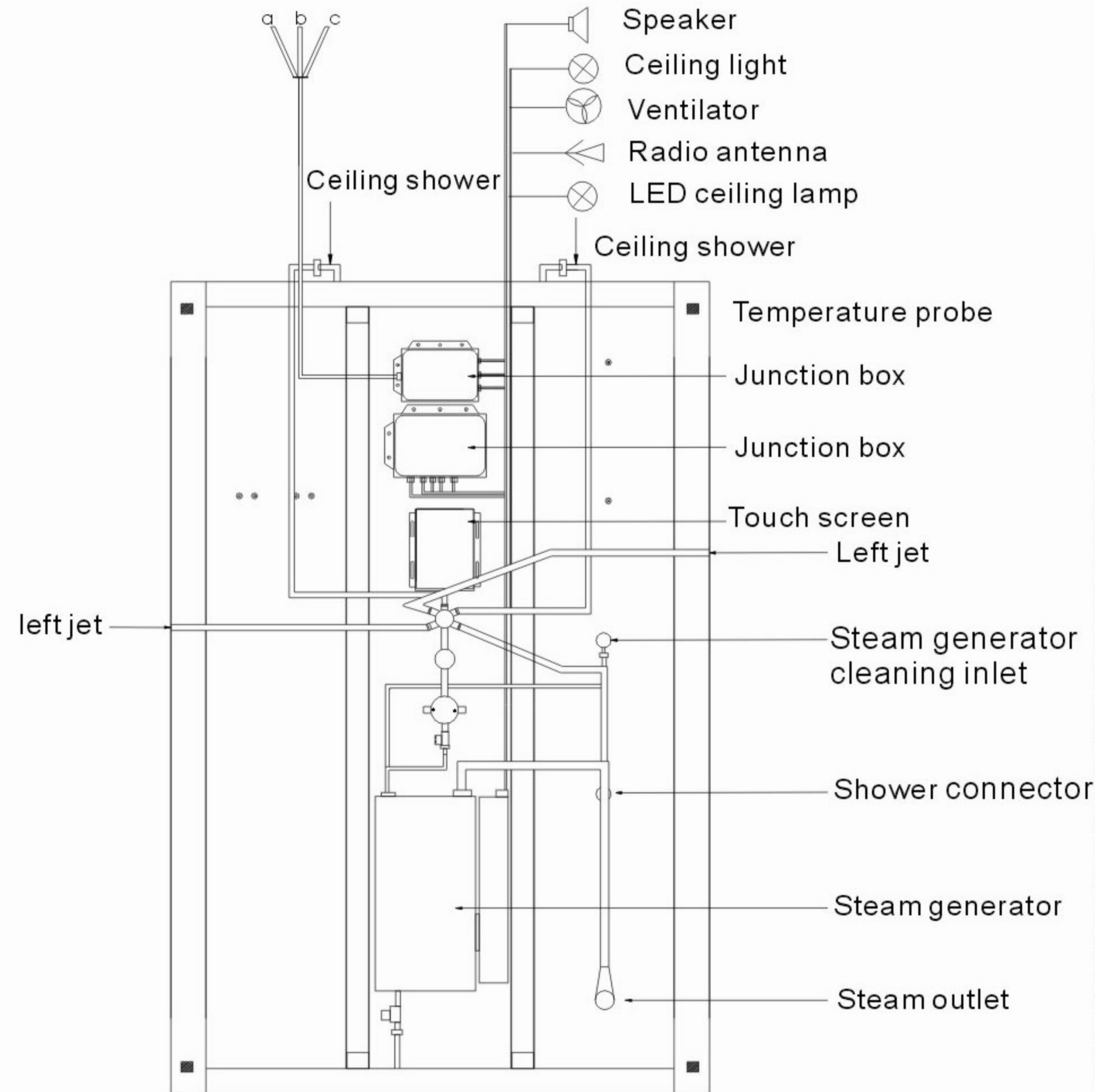

## Standard thermostatic faucet

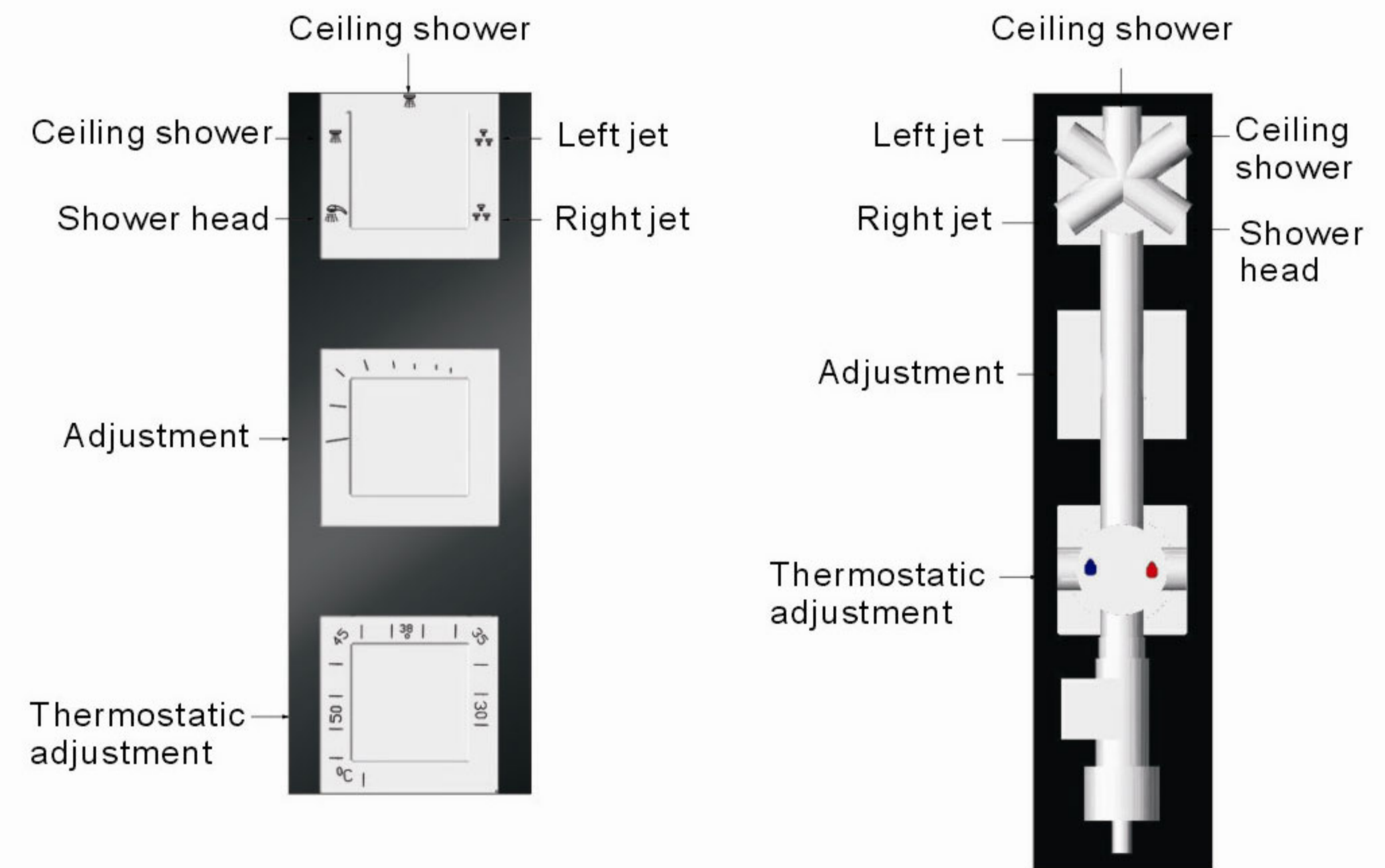



# F8 Control panel keys and operating instructions

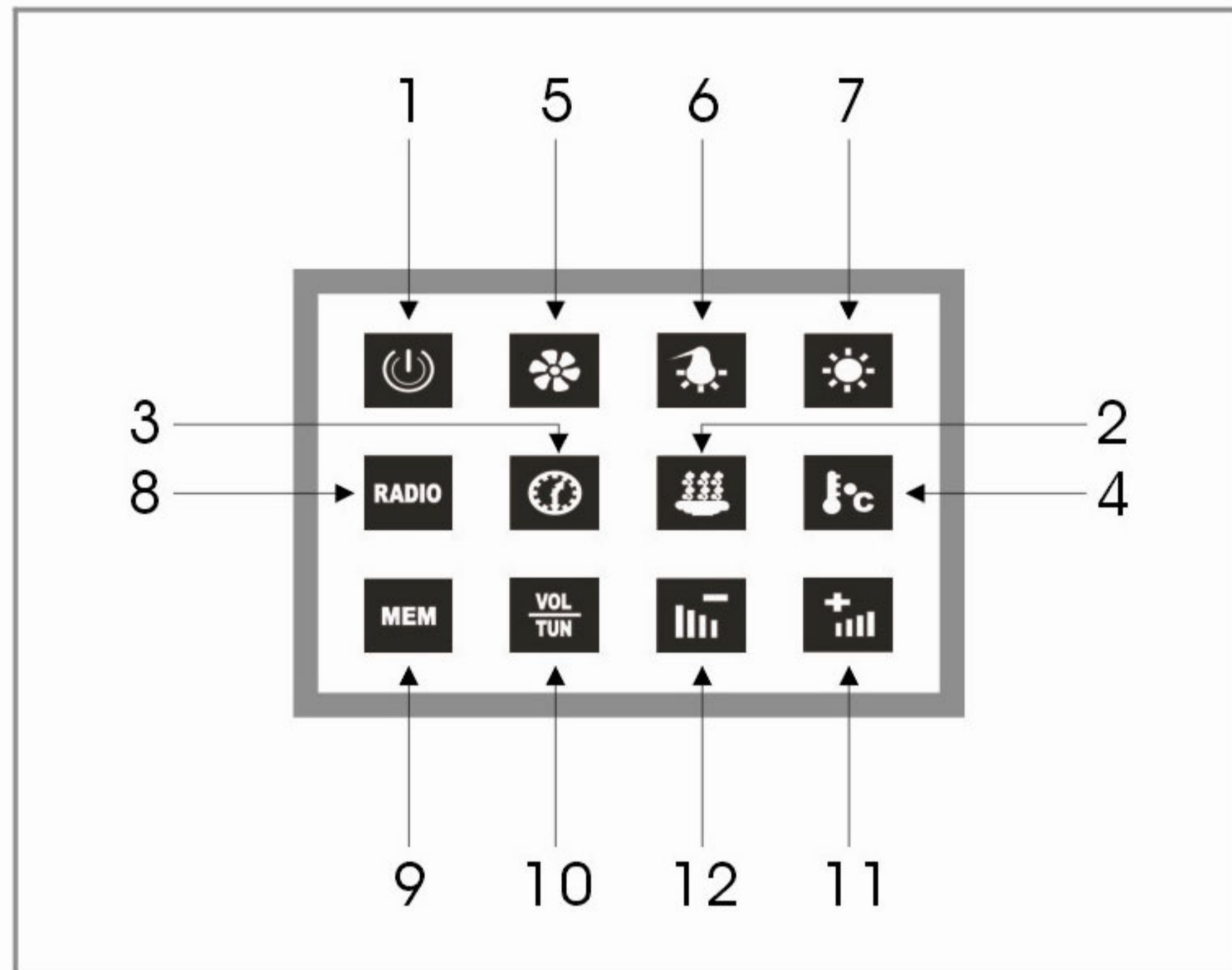

## 1).Power key

Press to switch on the steam room, press again to switch it off. The steam room will shut down in 60 minutes automatically. (As picture 1)

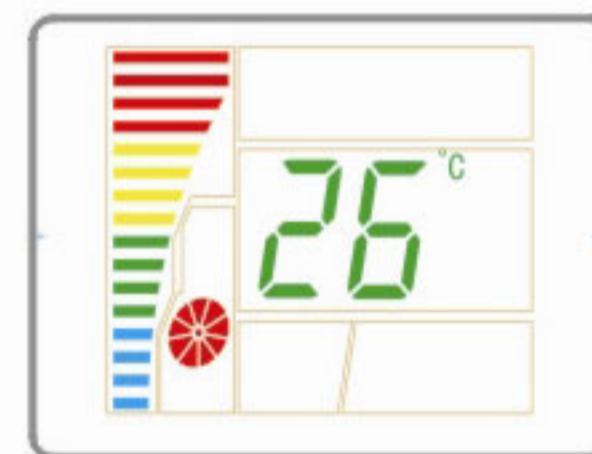

As picture 1

## 2).Steam key

Press The steam generator starts working. The temperature will be shown on the control panel like the picture 2.

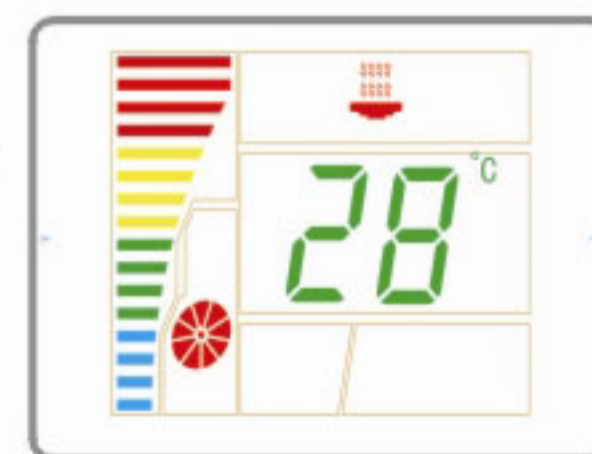

As picture 2

## 3).Time adjusting

After the steam function is turned on, press will increase the setting time. When press the more than 1 second, the setting time will be increased continuously until you stop pressing. Or, just when it reaches the maximum limiting time (50 minutes) after that it will return to the minimum limiting time (5 minutes) automatically.



As picture 3

Note: The time setting range is between 5-50 minutes. The default time setting is 30 minutes. (As picture 3)

## 4).Temperature adjusting key

After steam function is turned on, press will increase the temperature. When press more than 1 second, the setting temperature will be increased continuously until you stop pressing. Or, just when it reaches the maximum limiting temperature that it will return to the minimum limiting temperature automatically.



As picture 4

Note: The temperature setting range is between 20 °C -50 °C /68 °F -122 °F. The controlled temperature tolerance: ±3 °C /±37 °F. The default temperature is 40 °C /104 °F.

## 5).Ventilator key

Press to turn on the ventilator, press again to turn off the ventilator.



As picture 5



## 6).Color light key

Press  to turn on the color light. After the color light is turned on, each more press will change the different colors of the light. The color light works in this sequence: Turn on, blue ---blue and red ---red-----red and orange---orange ---orange and blue---blue---circulating---turn off.



As picture6

## 7).lamp key

Press the  key to turn on the lamp, press  again and turn it off. (As picture 6)



## 8).Radio key

Press  to turn on the radio, press  again to turn off the radio.( As picture 7)





As picture7

## 9).Channel memory key

Press  and release within 1 second, the frequency of current channel will be changed; Press  and hold it more than 1 second, the frequency of current channel will be saved.It can memory total 8 channels.

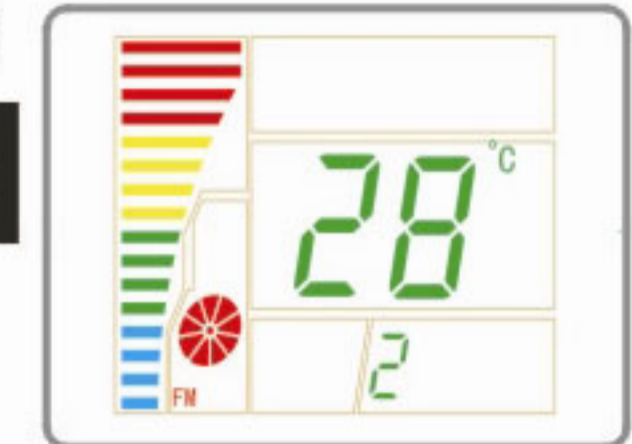

## 10).Select key

This key gets double functions. When the radio is turned on, this key shows the Frequency function.Press the  key and it can be switched from the frequency to the volume function. Press the  key, on the Displayer will show like the (Picture 10) or (picture 9). (Picture 9) is for volume and (picture 10) is for frequency.



As picture8

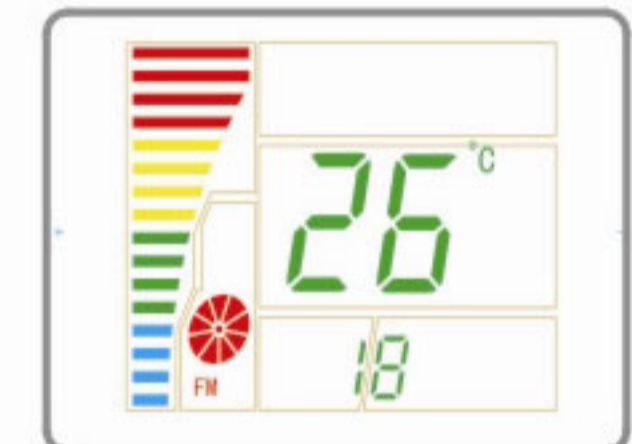

## 11).Volume up key

After the radio is turned on (As picture9), press  will increase the volume. Hold on the key more than 1 second, volume will keep increasing until the key is released. When( picture10) shows on the displayer, press  will increase the frequency.Hold on the key more than 1 second, the frequency will keep increasing until the key is released.



As picture9

## 12).Volume down key

After the radio is turned on, when (Picture 9) is shown on the displayer, press  will decrease the volume. Hold on the key more than 1 second, volumed will keep decreasing until the key is released. When ( picture10) is shown on the displayer,press  will decrease the frequency.Hold on the key more than 1 second, the frequency will keep decreasing until the key is released.



As pictur10

# User's manual for cleaning the steem generator

Using steps: Turn off the power first, and then open the lid of cleanning cup, put the cleaning liquid in the cleanning cup, after that, cover the lid back. Now turn on the power , start the steam function to make the self-cleaning function work, later turn off the power, and pipe water away.

## 1).Power off

For safety, it is strictly prohibited to open the lid of the easy cleaning cup during using. In order to avoid steam gas emits out and scald users, please shut down all other functions before using the steam generator  cleaning function. (As picture 11)

## 2).Open the easy cleaning cup

After Making sure all of functions are turned off, find out the cleaning cup according the right picture illustrated, and rotate the lid of the cleaning cup to the reverse direction, and then take the lid out slightly. ( As picture12)



## 3).put the cleaning liquid

After opening the cleanning cup, use a spoon to take a proper amount of cleaning liquid, such as Citric acid, or neutral compound cleaning liquid ( around 5 ml) to put in the cleaning cup. Note: If the cleaning material is solid, first, please dissolve it with water to prevent blcoking.Strictly prohibit to use any other acid, alkaline compounds to be pour ed into the cleanning cup directly( As picture13).



## 4).Cover the lid

After adding the cleaning liquid, cover the lid back and turn it in clockwise direction to fasten,like this can prevent the steam emitting out to scald users( As picture14).

## 5).Turn on and start the steam function

After covering the lid, press  to turn on the steam generator function, and the system  will begin to clean the steam box automatically.( As picture15)

## 6).Turn off the power and drain out the waste water

After 5-10 minutes, press the  to turn off the steam generator, then press the , the waste water will be drained out automatically( As picture16).

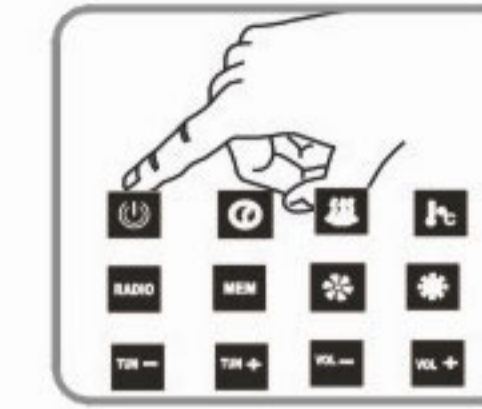

As picture 11

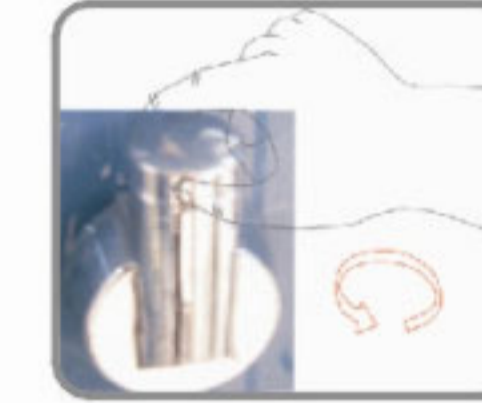

As picture 12



As picture 13

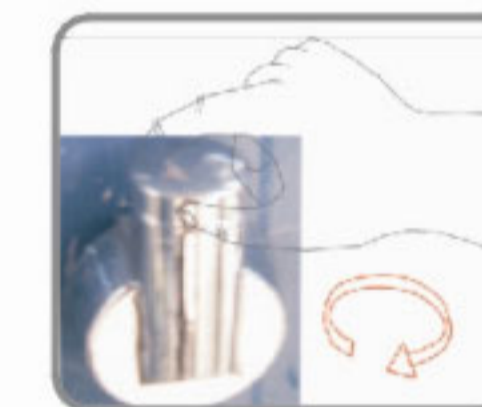

As picture 14

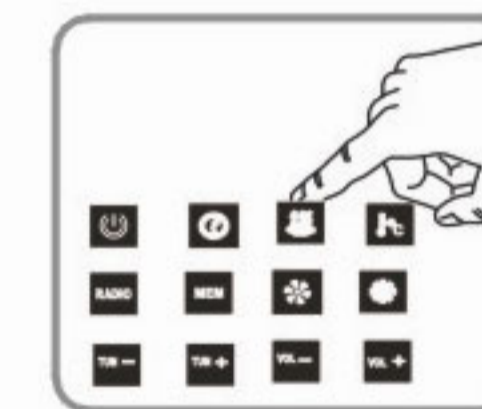

As picture 15

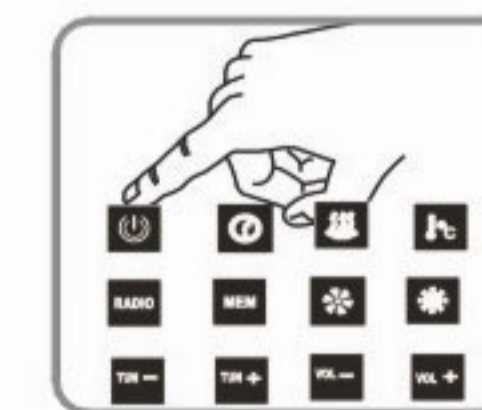

As picture 16

### Notice:

1. Strictly prohibit to use the cleaning function while any other function is on;
  2. Strictly prohibit to use any other alkaline cleaning compound to clean steam generator;
  3. Strictly prohibit to use any solid cleaning agent to clean steam generator, in order to avoid blocking the pipe.
- We recommend that you use citric acid solution to clean steam generator!

Maintenance service card			
Item number			
Serial number		Purchasing date	
Phone number			
<p>Eago guarantees to keep:            Eago series' products in good repair against the maintenance service card and purchasing receipt since the purchasing date. If it is the product quality problem, it will be free maintenance or change the spare parts. If the problem is not caused by the products itself or over-exceed the one-year guarantee, it will charge the repairing fees and spare parts costs.</p>			

The first page is kept for the customer.

Maintenance service card	
Item number	
Serial number	
Customer name	
Phone number	
Address	
Agent shop	
Phone number	
Purchasing date	

The second page is sent back to eago head office.

## Maintenance service card

Item number	
Serial number	
Customer name	
Phone number	
Address	
Agent shop	
Phone number	
Purchasing date	

## Steam shower room trouble shooting

Malfunction Status	Reasons	Solutions
Small volume inlet water	<ol style="list-style-type: none"> <li>1. Lower inlet water pressure</li> <li>2. The water inlet pipe is blocked</li> </ol>	<ol style="list-style-type: none"> <li>1. Check the inlet water pressure, then check with local plumber</li> <li>2. Clean the filtre</li> </ol>
Water divert valve can't divert water	<ol style="list-style-type: none"> <li>1. Rubber inside the valve damaged or distorted</li> </ol>	<ol style="list-style-type: none"> <li>1. Change a new one</li> </ol>
No signal on the control panel	<ol style="list-style-type: none"> <li>1. There is no power in the user's house or the wire not connected well</li> <li>2. Not switch the power on</li> <li>3. The connecting wire for the control panel becomes loose</li> </ol>	<ol style="list-style-type: none"> <li>1. Need to wait the power on, connect wires in right way</li> <li>2. Swtich on the power</li> <li>3. Take it off and install it again, don't forget fasten it</li> </ol>
There is steam signal on the control panle, but no steam comes out	<ol style="list-style-type: none"> <li>1. The Temperature limiter operate or the heater is broken</li> </ol>	<ol style="list-style-type: none"> <li>1. Ask help to qualified people</li> </ol>
Chromatherapy light doesn't work	<ol style="list-style-type: none"> <li>1. The connecting wire blew out or the lamp holder loosen</li> <li>2. Lamp pannel is broken</li> </ol>	<ol style="list-style-type: none"> <li>1. Change a new one or install it well again</li> <li>2. Change a new one</li> </ol>
Ventilator doesn't work	<ol style="list-style-type: none"> <li>1. The connecting wire is off</li> <li>2. The fan blade gets stuck</li> <li>3. The ventilation fan is broken</li> </ol>	<ol style="list-style-type: none"> <li>1. Reconnect it well</li> <li>2. When the fan is on spur the blades slightly</li> <li>3. Change a new one</li> </ol>