

FLEX PENINSULA FIREPLACES

FIREPLACE INSERTS



<p>空間の間仕切りでの使用に</p> <p>Peninsula モデルは、前面、背面、側面にある3カ所の開口部から炎を眺めることができます。</p>	<p>受賞歴</p> <p>建築製品の優れたイノベーションに対し授与される2020 BIMsmith Bestを受賞。</p> 	<p>グローバルコンプライアンス</p> <p>すべてのモデルは、アメリカ、ヨーロッパ、イギリス、オーストラリアの既存の規格に準拠しています。UL規格、EN 16647 BSI認定、ACCC安全基準に準拠。</p>
<p>装飾用 Side Box</p> <p>暖炉の片側または両側に装飾ボックスを置いてカスタマイズできます。お好みの不燃性アクセサリを組み合わせれば完成です。</p>	<p>クリーンな燃焼</p> <p>空気を汚さない e-NRG バイオエタノールを使用。</p>	<p>強化した安全スクリーン</p> <p>FLEXシリーズは、風の強い条件でも炎を安定させ、安全性と快適性をさらに高めるために強化ガラスを採用しています。</p>
		
<p>Colors</p> <p>本体は炎をより美しく魅せるblack。本製品はstainlessのバーナーと装飾用の黒いガラス石が標準装備されています。</p>	<p>一生使える丈夫さ</p> <p>つや消しブラック粉体焼付塗装を施した鉄を使用することにより、耐熱性や錆びつきを防いでいるため、屋内・屋外どちらでもお使いいただけます。</p>	<p>Zero Clearance</p> <p>独立型のゼロ・クリアランス構造により、木下地や金属下地のスタッドにはめ込むことが可能です。施工会社・建築家・インテリアデザイナー、そして住宅のオーナーにとって設置の自由度と可能性が広がります。</p>
<p>装飾用 Steel Log Sets</p> <p>EcoSmart Fireでは、装飾用のサイドボックスが付いているモデルのためのステンレス製の装飾用の薪をオプションとしてご用意しております。風格のある真鍮と銅、2種類の仕上げからお選びいただけます。 *本製品は直火のあたる場所に設置しないでください。これらは直火ではなく暖炉の側で使用するための熱を考慮した設計となっています。</p>		
<p>付属品</p>  <p>Jerry Can Lighting Rod + Lighter Baffles (XLシリーズのみ) Black Glass Charcoal</p>	<p>別売付属品</p>  <p>Decorative Steel Logs</p>	

Peninsula Fireplaces

設置場所	Indoor & Outdoor
素材	Mild Steel (Zinc Sealed), Toughened Glass, Stainless Steel & Black Glass Charcoal as Decorative Media
色	■ Black *内蔵バーナーはStainless色となります。
燃料	e-NRG バイオエタノール

FLEX18

ESF.1.FX.18PN

価格	280,000円 (税別)
重量	34.2kg (内蔵バーナー、ガラス、石含む)
内蔵 Burner*	AB3 x 1
燃料タンク容量	2.5 Litres x 1
暖房の目安	20m ² 以上 (屋内使用時)
燃焼継続時間	約 8 - 11 hours
換気	1台あたり少なくとも 40m ³ 室内容積を確保して下さい

バーナーのご使用前には必ず取扱説明書をお読みください。

*これらの値は参考値であり、購入したモデル、設置方法、設置環境およびe-NRGの製造時期等により異なります。

Model can be rotated

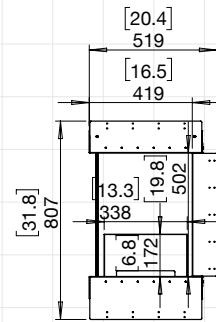

18PN (FLAME ONLY)

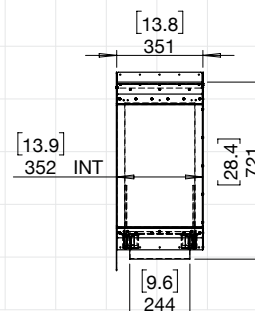

SIDE VIEW

FOR MORE INFORMATION PLEASE REFERENCE THE CLEARANCE & INSTALLATION MANUAL

Disclaimer: All product specifications and data are subject to change without notice and believed to be correct at the time of publication. MAD Design Group (MDG), its affiliates, agents and employees and all persons acting on its behalf (collectively, "MAD Design Group"), disclaim any and all liability for errors, inaccuracies or incompleteness contained herein or in any other disclosure relating to any product. MDG disclaims any and all liability arising out of the use or application of any product described herein or of any information provided herein to the maximum extent permitted by law. The product specifications do not expand or otherwise modify MDG's terms and conditions of purchase, including but not limited to the warranty expressed herein, which apply to these products. No license, express or implied, by estoppel or otherwise to any intellectual property rights is granted by this document to any conduct of MDG. Customers using or selling MDG products not expressly indicated for use in such applications do so entirely at their own risk and agree to fully indemnify MDG for any damages arising or resulting from such use or sale. Please contact authorized personnel from MDG to obtain written terms and conditions regarding products designed for such applications. Images are indicative only.

Peninsula Fireplaces

設置場所	Indoor & Outdoor
素材	Mild Steel (Zinc Sealed), Toughened Glass, Stainless Steel & Black Glass Charcoal as Decorative Media
色	■ Black *内蔵バーナーはStainless色となります。
燃料	e-NRG バイオエタノール

FLEX32

ESF.1.FX.32PN

価格	580,000円 (税別)
重量	49.8kg (内蔵バーナー、ガラス、石含む)
内蔵 Burner*	XL500 x 1
燃料タンク容量	5 Litres x 1
暖房の目安	40m ² 以上 (屋内使用時)
燃焼継続時間	約 10 - 13 hours
換気	1台あたり少なくとも 80m ³ 室内容積を確保して下さい

バーナーのご使用前には必ず取扱説明書をお読みください。

*これらの値は参考値であり、購入したモデル、設置方法、設置環境およびe-NRGの製造時期等により異なります。

Model can be rotated

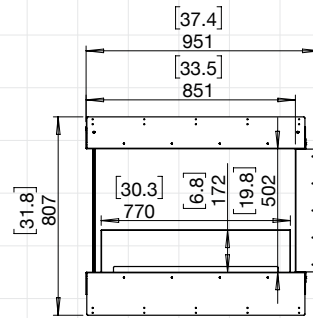

32PN (FLAME ONLY)

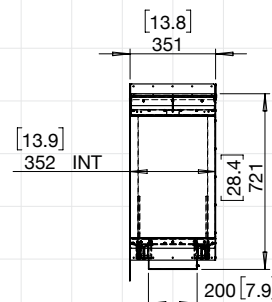

SIDE VIEW

FOR MORE INFORMATION PLEASE REFERENCE THE CLEARANCE & INSTALLATION MANUAL

Disclaimer: All product specifications and data are subject to change without notice and believed to be correct at the time of publication. MAD Design Group (MDG), its affiliates, agents and employees and all persons acting on its behalf collectively ("MAD Design Group"), disclaim any and all liability for errors, inaccuracies or incompleteness contained herein or in any other disclosure relating to any product. MDG disclaims any and all liability arising out of the use or application of any product described herein or of any information provided herein to the maximum extent permitted by law. The product specifications do not expand or otherwise modify MDG's terms and conditions of purchase, including but not limited to the warranty expressed herein, which apply to these products. No license, express or implied, by estoppel or otherwise, to any intellectual property rights is granted by this document to any conduct of MDG. Customers using or selling MDG products not expressly indicated for use in such applications do so entirely at their own risk and agree to fully indemnify MDG for any damages arising or resulting from such use or sale. Please contact authorized personnel from MDG to obtain written terms and conditions regarding products designed for such applications. Images are indicative only.

Peninsula Fireplaces

設置場所	Indoor & Outdoor
素材	Mild Steel (Zinc Sealed), Toughened Glass, Stainless Steel & Black Glass Charcoal as Decorative Media
色	<div style="display: flex; align-items: center;"> <div style="width: 15px; height: 15px; background-color: black; margin-right: 5px;"></div> Black </div> <small>*内蔵バーナーはStainless色となります。</small>
燃料	e-NRG バイオエタノール

FLEX42

ESF.1.FX.42PN

価格	650,000円 (税別)
重量	64.7kg (内蔵バーナー、ガラス、石含む)
内蔵 Burner*	XL700 x 1
燃料タンク容量	7 Litres x 1
暖房の目安	50m ² 以上 (屋内使用時)
燃焼継続時間	約 9 - 12 hours
換気	1台あたり少なくとも 90m ³ 室内容積を確保して下さい

バーナーのご使用前には必ず取扱説明書をお読みください。

*これらの値は参考値であり、購入したモデル、設置方法、設置環境およびe-NRGの製造時期等により異なります。

Model can be rotated

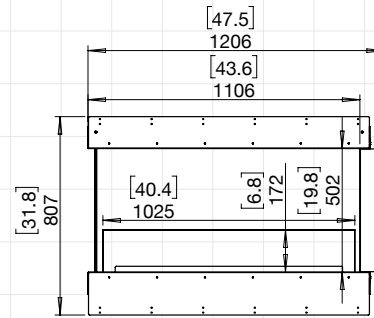

42PN (FLAME ONLY)

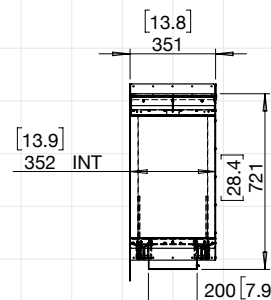

SIDE VIEW

FOR MORE INFORMATION PLEASE REFERENCE THE CLEARANCE & INSTALLATION MANUAL

Disclaimer: All product specifications and data are subject to change without notice and believed to be correct at the time of publication. MAD Design Group (MDG), its affiliates, agents and employees and all persons acting on its behalf collectively ("MAD Design Group"), disclaim any and all liability for errors, inaccuracies or incompleteness contained herein or in any other disclosure relating to any product. MDG disclaims any and all liability arising out of the use or application of any product described herein or of any information provided herein to the maximum extent permitted by law. The product specifications do not expand or otherwise modify MDG's terms and conditions of purchase, including but not limited to the warranty expressed herein, which apply to these products. No license, express or implied, by estoppel or otherwise to any intellectual property rights is granted by this document to any conduct of MDG. Customers using or selling MDG products not expressly indicated for use in such applications do so entirely at their own risk and agree to fully indemnify MDG for any damages arising or resulting from such use or sale. Please contact authorized personnel from MDG to obtain written terms and conditions regarding products designed for such applications. Images are indicative only.

Peninsula Fireplaces

設置場所	Indoor & Outdoor
素材	Mild Steel (Zinc Sealed), Toughened Glass, Stainless Steel & Black Glass Charcoal as Decorative Media
色	■ Black *内蔵バーナーはStainless色となります。
燃料	e-NRG バイオエタノール

FLEX50

ESF.1.FX.50PN

価格	820,000円 (税別)
重量	59.1kg (内蔵バーナー、ガラス、石含む)
内蔵 Burner*	XL900 x 1
燃料タンク容量	9 Litres x 1
暖房の目安	60m ² 以上 (屋内使用時)
燃焼継続時間	約 8 - 13 hours
換気	1台あたり少なくとも 110m ³ 室内容積を確保して下さい

ESF.1.FX.50PN.BXL ESF.1.FX.50PN.BXR

価格	820,000円 (税別)
重量	73.2kg (内蔵バーナー、ガラス、石含む)
内蔵 Burner*	XL500 x 1
燃料タンク容量	5 Litres x 1
暖房の目安	40m ² 以上 (屋内使用時)
燃焼継続時間	約 10 - 13 hours
換気	1台あたり少なくとも 80m ³ 室内容積を確保して下さい

バーナーのご使用前には必ず取扱説明書をお読みください。

*これらの値は参考値であり、購入したモデル、設置方法、設置環境およびe-NRGの製造時期等により異なります。

→
All models can be rotated

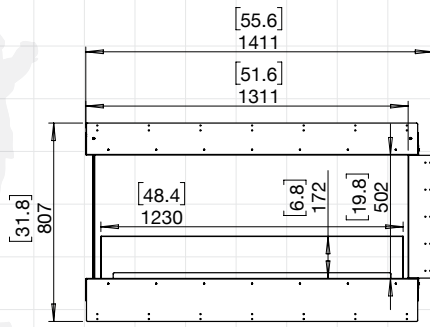

50PN (FLAME ONLY)

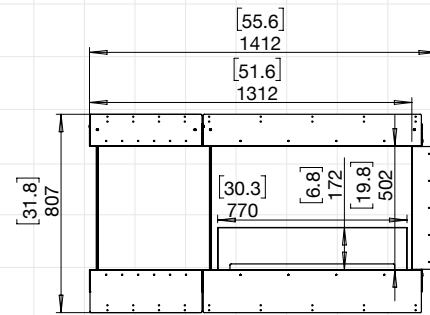

50PN.BXL (LEFT DECORATIVE BOX)

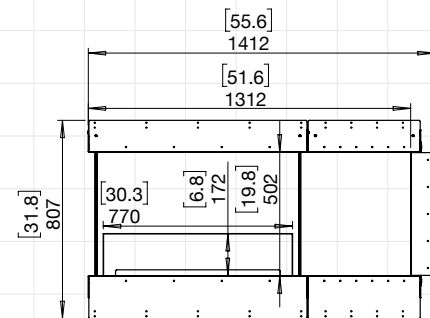

50PN.BXR (RIGHT DECORATIVE BOX)

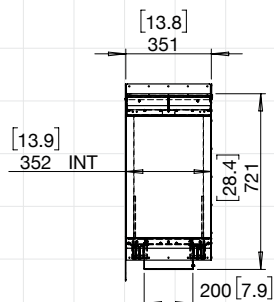

SIDE VIEW

FOR MORE INFORMATION PLEASE REFERENCE THE CLEARANCE & INSTALLATION MANUAL

Disclaimer: All product specifications and data are subject to change without notice and believed to be correct at the time of publication. MAD Design Group (MDG), its affiliates, agents and employees and all persons acting on its behalf (collectively, "MAD Design Group") disclaim any and all liability for errors, inaccuracies or incompleteness contained herein or in any other disclosure relating to any product. MDG disclaims any and all liability arising out of the use or application of any product described herein or of any information provided herein to the maximum extent permitted by law. The product specifications do not expand or otherwise modify MDG's terms and conditions of purchase, including but not limited to the warranty expressed herein, which apply to these products. No license, express or implied, by estoppel or otherwise to any intellectual property rights is granted by this document to any product of MDG. Customers using or selling MDG products not expressly indicated for use in such applications do so entirely at their own risk and agree to fully indemnify MDG for any damages arising from such use or sale. Please contact authorized personnel from MDG to obtain written terms and conditions regarding products designed for such applications. Images are indicative only.

Peninsula Fireplaces

設置場所	Indoor & Outdoor
素材	Mild Steel (Zinc Sealed), Toughened Glass, Stainless Steel & Black Glass Charcoal as Decorative Media
色	■ Black *内蔵バーナーはStainless色となります。
燃料	e-NRG バイオエタノール

FLEX60

ESF.1.FX.60PN.BXL
ESF.1.FX.60PN.BXR

価格	880,000円 (税別)
重量	87.5kg (内蔵バーナー、ガラス、石含む)
内蔵 Burner*	XL700 x 1
燃料タンク容量	7 Litres x 1
暖房の目安	50m ² 以上 (屋内使用時)
燃焼継続時間	約 9 - 12 hours
換気	1台あたり少なくとも 90m ³ 室内容積を確保して下さい

バーナーのご使用前には必ず取扱説明書をお読みください。

*これらの値は参考値であり、購入したモデル、設置方法、設置環境およびe-NRGの製造時期等により異なります。

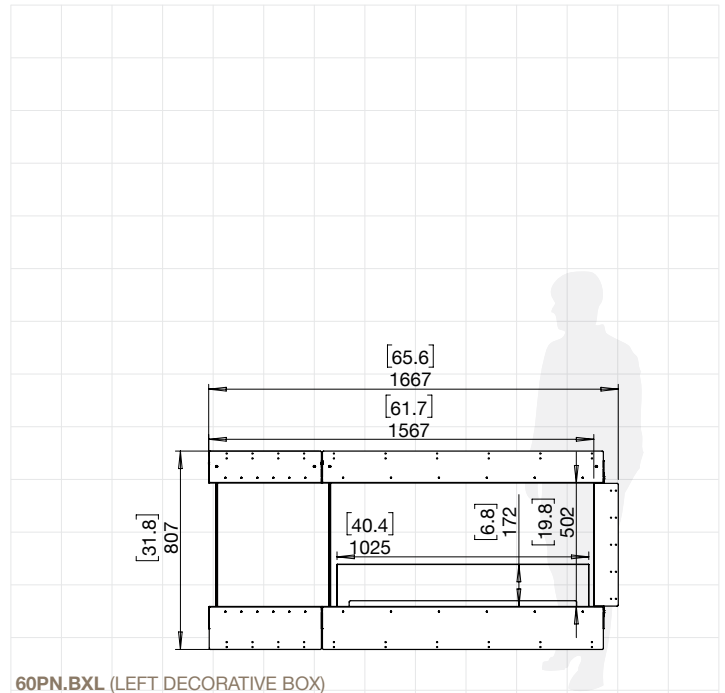

60PN.BXL (LEFT DECORATIVE BOX)

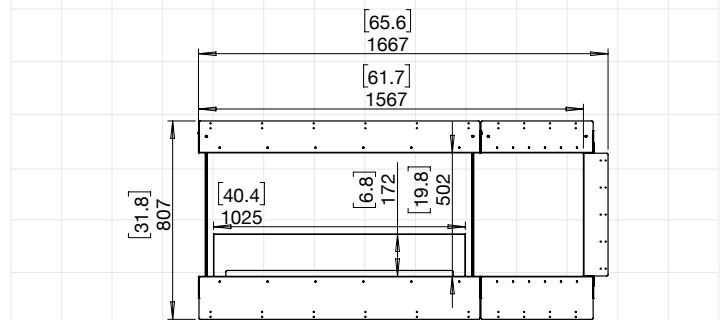

60PN.BXR (RIGHT DECORATIVE BOX)

→
All models can be rotated

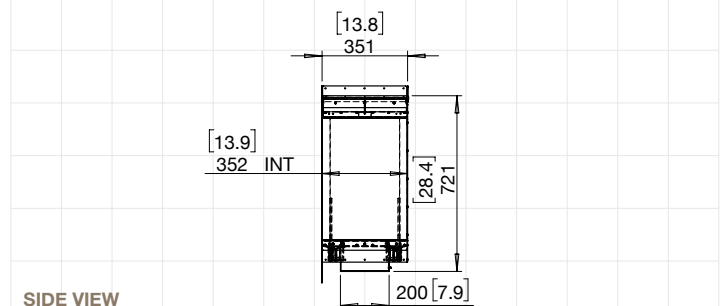

SIDE VIEW

FOR MORE INFORMATION PLEASE REFERENCE THE CLEARANCE & INSTALLATION MANUAL

Disclaimer: All product specifications and data are subject to change without notice and believed to be correct at the time of publication. MAD Design Group (MDG), its affiliates, agents and employees and all persons acting on its behalf collectively ("MAD Design Group"), disclaim any and all liability for errors, inaccuracies or incompleteness contained herein or in any other disclosure relating to any product. MDG disclaims any and all liability arising out of the use or application of any product described herein or of any information provided herein to the maximum extent permitted by law. The product specifications do not expand or otherwise modify MDG's terms and conditions of purchase, including but not limited to the warranty expressed herein, which apply to these products. No license, express or implied, by estoppel or otherwise to any intellectual property rights is granted by this document to any conduct of MDG. Customers using or selling MDG products not expressly indicated for use in such applications do so entirely at their own risk and agree to fully indemnify MDG for any damages arising or resulting from such use or sale. Please contact authorized personnel from MDG to obtain written terms and conditions regarding products designed for such applications. Images are indicative only.

Peninsula Fireplaces

設置場所	Indoor & Outdoor
素材	Mild Steel (Zinc Sealed), Toughened Glass, Stainless Steel & Black Glass Charcoal as Decorative Media
色	<div style="display: flex; align-items: center;"> <div style="width: 15px; height: 15px; background-color: black; margin-right: 5px;"></div> Black </div> <small>*内蔵バーナーはStainless色となります。</small>
燃料	e-NRG バイオエタノール

FLEX68

ESF.2.FX.68PN

価格	1,100,000円 (税別)
重量	102.8kg (内蔵バーナー、ガラス、石含む)
内蔵 Burner*	XL1200 x 1
燃料タンク容量	10 Litres x 1
暖房の目安	65m ² 以上 (屋内使用時)
燃焼継続時間	約 9 - 14 hours
換気	1台あたり少なくとも 115m ³ 室内容積を確保して下さい

ESF.1.FX.68PN.BX2

価格	1,100,000円 (税別)
重量	96.1kg (内蔵バーナー、ガラス、石含む)
内蔵 Burner*	XL500 x 1
燃料タンク容量	5 Litres x 1
暖房の目安	40m ² 以上 (屋内使用時)
燃焼継続時間	約 10 - 13 hours
換気	1台あたり少なくとも 80m ³ 室内容積を確保して下さい

ESF.1.FX.68PN.BXL ESF.1.FX.68PN.BXR

価格	1,100,000円 (税別)
重量	83.9kg (内蔵バーナー、ガラス、石含む)
内蔵 Burner*	XL900 x 1
燃料タンク容量	9 Litres x 1
暖房の目安	60m ² 以上 (屋内使用時)
燃焼継続時間	約 8 - 13 hours
換気	1台あたり少なくとも 110m ³ 室内容積を確保して下さい

バーナーのご使用前には必ず取扱説明書をお読みください。

*これらの値は参考値であり、購入したモデル、設置方法、設置環境およびe-NRGの製造時期等により異なります。

→
All models can be rotated

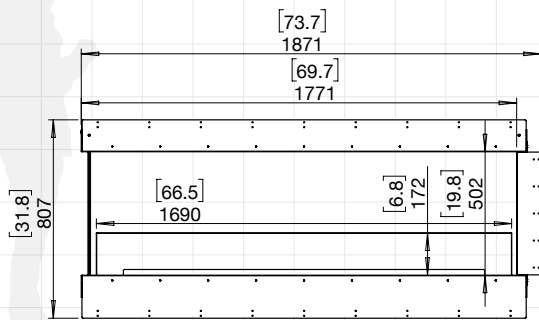

68PN (FLAME ONLY)

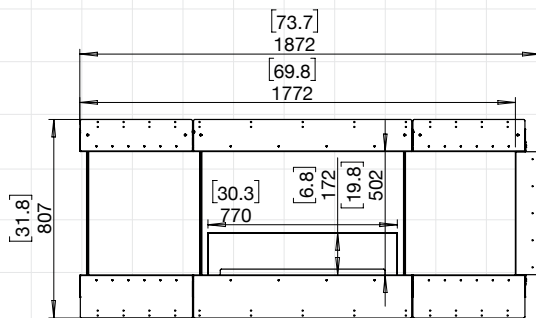

68PN.BX2 (LEFT & RIGHT DECORATIVE BOXES)

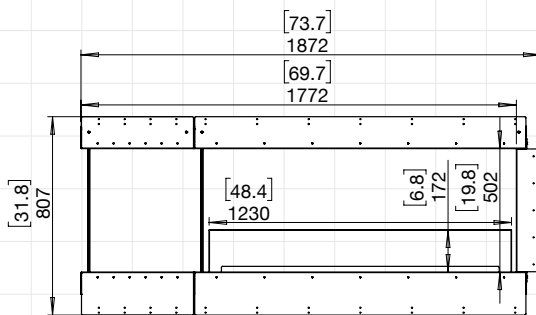

68PN.BXL (LEFT DECORATIVE BOX AS ILLUSTRATED)
68PN.BXR (RIGHT DECORATIVE BOX)

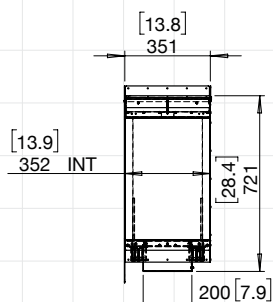

SIDE VIEW

FOR MORE INFORMATION PLEASE REFERENCE THE CLEARANCE & INSTALLATION MANUAL

Disclaimer: All product specifications and data are subject to change without notice and are believed to be correct at the time of publication. MAD Design Group (MDG), its affiliates, agents and employees and all persons acting on its behalf collectively ("MAD Design Group") disclaim any and all liability for any errors, inaccuracies or incompleteness contained herein or in any other disclosure relating to any product. MDG disclaims any and all liability arising out of the use or application of any product described herein or of any information provided herein to the maximum extent permitted by law. The product specifications do not expand or otherwise modify MDG's terms and conditions of purchase, including but not limited to the warranty expressed herein, which apply to these products. No license, express or implied, by estoppel or otherwise, to any intellectual property rights is granted by this document to any product of MDG. Customers using or selling MDG products not expressly indicated for use in such applications do so entirely at their own risk and agree to fully indemnify MDG for any damages arising from such use or sale. Please contact authorized personnel from MDG to obtain written terms and conditions regarding product design and for such applications. Images are indicative only.

Peninsula Fireplaces

設置場所	Indoor & Outdoor
素材	Mild Steel (Zinc Sealed), Toughened Glass, Stainless Steel & Black Glass Charcoal as Decorative Media
色	<div style="display: flex; align-items: center;"> <div style="width: 15px; height: 15px; background-color: black; margin-right: 5px;"></div> Black </div> <small>*内蔵バーナーはStainless色となります。</small>
燃料	e-NRG バイオエタノール

FLEX78

ESF.1.FX.78PN.BX2

価格	1,200,000円 (税別)
重量	110.4kg (内蔵バーナー、ガラス、石含む)
内蔵 Burner*	XL700 x 1
燃料タンク容量	7 Litres x 1
暖房の目安	50m ² 以上 (屋内使用時)
燃焼継続時間	約 9 - 12 hours
換気	1台あたり少なくとも 90m ³ 室内容積を確保して下さい

バーナーのご使用前には必ず取扱説明書をお読みください。

*これらの値は参考値であり、購入したモデル、設置方法、設置環境およびe-NRGの製造時期等により異なります。

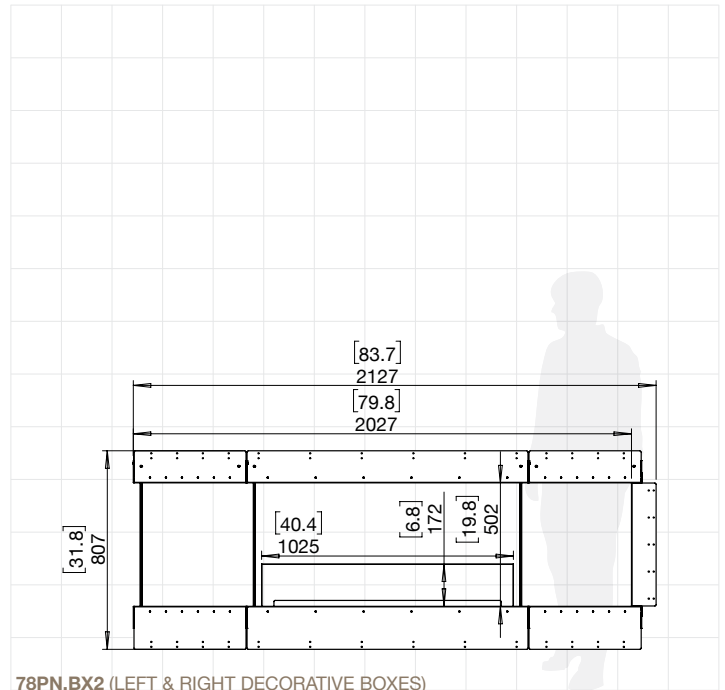

78PN.BX2 (LEFT & RIGHT DECORATIVE BOXES)

→
Models can be rotated

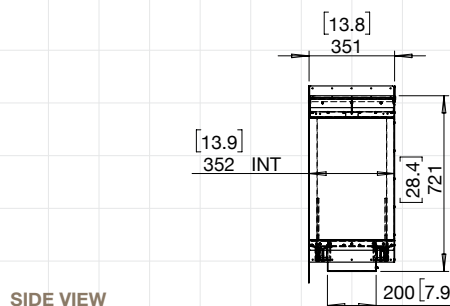

SIDE VIEW

FOR MORE INFORMATION PLEASE REFERENCE THE CLEARANCE & INSTALLATION MANUAL

Disclaimer: All product specifications and data are subject to change without notice and believed to be correct at the time of publication. MAD Design Group (MDG), its affiliates, agents and employees and all persons acting on its behalf collectively ("MAD Design Group"), disclaim any and all liability for errors, inaccuracies or incompleteness contained herein or in any other disclosure relating to any product. MDG disclaims any and all liability arising out of the use or application of any product described herein or of any information provided herein to the maximum extent permitted by law. The product specifications do not expand or otherwise modify MDG's terms and conditions of purchase, including but not limited to the warranty expressed herein, which apply to these products. No license, express or implied, by estoppel or otherwise to any intellectual property rights is granted by this document to any conduct of MDG. Customers using or selling MDG products not expressly indicated for use in such applications do so entirely at their own risk and agree to fully indemnify MDG for any damages arising or resulting from such use or sale. Please contact authorized personnel from MDG to obtain written terms and conditions regarding products designed for such applications. Images are indicative only.

Peninsula Fireplaces

設置場所	Indoor & Outdoor
素材	Mild Steel (Zinc Sealed), Toughened Glass, Stainless Steel & Black Glass Charcoal as Decorative Media
色	■ Black *内蔵バーナーはStainless色となります。
燃料	e-NRG バイオエタノール

FLEX86

ESF.1.FX.86PN

価格	1,380,000円 (税別)
重量	102.5kg (内蔵バーナー、ガラス、石含む)
内蔵 Burner*	XL900 x 2
燃料タンク容量	9 Litres x 2
暖房の目安	120m ² 以上 (屋内使用時)
燃焼継続時間	約 8 - 13 hours
換気	1台あたり少なくとも 220m ³ 室内容積を確保して下さい

ESF.1.FX.86PN.BX2

価格	1,380,000円 (税別)
重量	108.7kg (内蔵バーナー、ガラス、石含む)
内蔵 Burner*	XL900 x 1
燃料タンク容量	9 Litres x 1
暖房の目安	60m ² 以上 (屋内使用時)
燃焼継続時間	約 8 - 13 hours
換気	1台あたり少なくとも 110m ³ 室内容積を確保して下さい

ESF.2.FX.86PN.BXL ESF.2.FX.86PN.BXR

価格	1,380,000円 (税別)
重量	124.1kg (内蔵バーナー、ガラス、石含む)
内蔵 Burner*	XL1200 x 1
燃料タンク容量	10 Litres x 1
暖房の目安	65m ² 以上 (屋内使用時)
燃焼継続時間	約 9 - 14 hours
換気	1台あたり少なくとも 115m ³ 室内容積を確保して下さい

バーナーのご使用前には必ず取扱説明書をお読みください。

*これらの値は参考値であり、購入したモデル、設置方法、設置環境およびe-NRGの製造時期等により異なります。

→
All models can be rotated

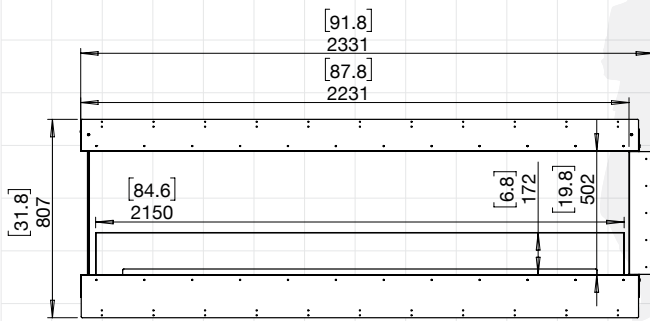

86PN (FLAME ONLY)

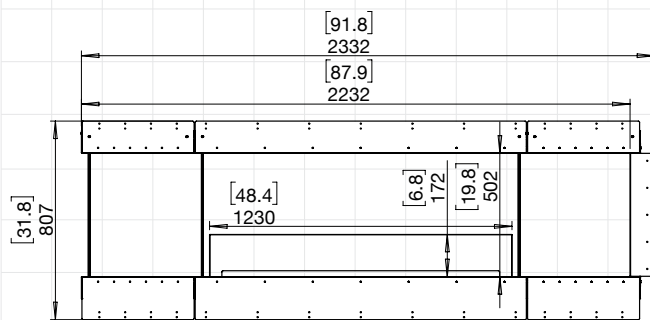

86PN.BX2 (LEFT & RIGHT DECORATIVE BOXES)

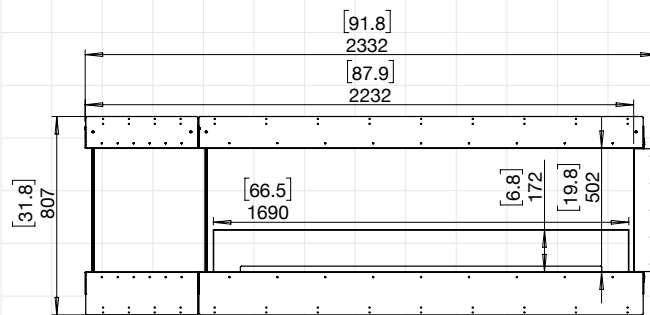

86PN.BXL (LEFT DECORATIVE BOX AS ILLUSTRATED)
86PN.BXR (RIGHT DECORATIVE BOX)

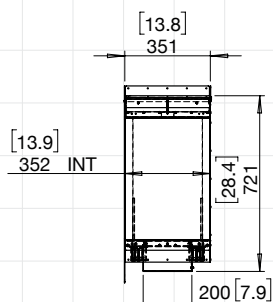

SIDE VIEW

FOR MORE INFORMATION PLEASE REFERENCE THE CLEARANCE & INSTALLATION MANUAL

Disclaimer: All product specifications and data are subject to change without notice and believed to be correct at the time of publication. MAD Design Group (MDG), its affiliates, agents and employees and all persons acting on its behalf collectively ("MAD Design Group") disclaim any and all liability for errors, inaccuracies or incompleteness contained herein or in any other disclosure relating to any product. MDG disclaims any and all liability arising out of the use or application of any product described herein to the maximum extent permitted by law. The product specifications do not expand or otherwise modify MDG's terms and conditions of purchase, including but not limited to the warranty expressed herein, which apply to these products. No license, express or implied, by estoppel or otherwise, to any intellectual property rights is granted by this document to any product of MDG. Customers using or selling MDG products not expressly indicated for use in such applications do so entirely at their own risk and agree to fully indemnify MDG for any damages arising from such use or sale. Please contact authorized personnel from MDG to obtain written terms and conditions regarding product design for such applications. Images are indicative only.

Peninsula Fireplaces

設置場所	Indoor & Outdoor
素材	Mild Steel (Zinc Sealed), Toughened Glass, Stainless Steel & Black Glass Charcoal as Decorative Media
色	■ Black *内蔵バーナーはStainless色となります。
燃料	e-NRG バイオエタノール

FLEX104

ESF.1.FX.104PN

価格	1,680,000円 (税別)
重量	153.3kg (内蔵バーナー、ガラス、石含む)
内蔵 Burner*	XL1200 x 2
燃料タンク容量	10 Litres x 2
暖房の目安	130m ² 以上 (屋内使用時)
燃焼継続時間	約 9 - 14 hours
換気	1台あたり少なくとも 230m ³ 室内容積を確保して下さい

ESF.2.FX.104PN.BX2

価格	1,680,000円 (税別)
重量	147.3kg (内蔵バーナー、ガラス、石含む)
内蔵 Burner*	XL1200 x 1
燃料タンク容量	10 Litres x 1
暖房の目安	65m ² 以上 (屋内使用時)
燃焼継続時間	約 9 - 14 hours
換気	1台あたり少なくとも 115m ³ 室内容積を確保して下さい

ESF.1.FX.104PN.BXL ESF.1.FX.104PN.BXR

価格	1,680,000円 (税別)
重量	127.3kg (内蔵バーナー、ガラス、石含む)
内蔵 Burner*	XL900 x 2
燃料タンク容量	9 Litres x 2
暖房の目安	120m ² 以上 (屋内使用時)
燃焼継続時間	約 8 - 13 hours
換気	1台あたり少なくとも 220m ³ 室内容積を確保して下さい

バーナーのご使用前には必ず取扱説明書をお読みください。

*これらの値は参考値であり、購入したモデル、設置方法、設置環境およびe-NRGの製造時期等により異なります。

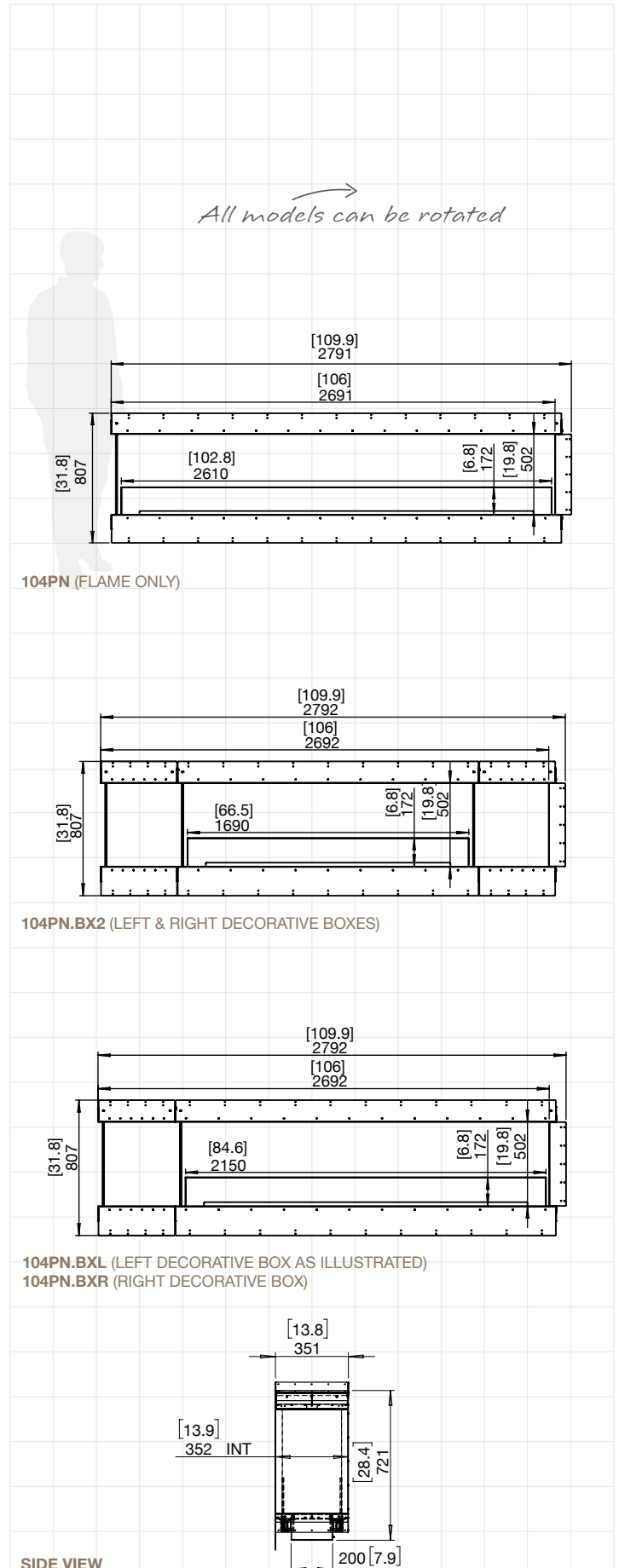

FOR MORE INFORMATION PLEASE REFERENCE THE CLEARANCE & INSTALLATION MANUAL

Disclaimer: All product specifications and data are subject to change without notice and believed to be correct at the time of publication. MAD Design Group (MDG), its affiliates, agents and employees and all persons acting on its behalf collectively ("MAD Design Group"), disclaim any and all liability for errors, inaccuracies or incompleteness contained herein or in any other disclosure relating to any product. MDG disclaims any and all liability arising out of the use or application of any product described herein or of any information provided herein to the maximum extent permitted by law. The product specifications do not expand or otherwise modify MDG's terms and conditions of purchase, including but not limited to the warranty expressed herein, which apply to these products. No license, express or implied, by estoppel or otherwise to any intellectual property rights is granted by this document to any product of MDG. Customers using or selling MDG products not expressly indicated for use in such applications do so entirely at their own risk and agree to fully indemnify MDG for any damages arising or resulting from such use or sale. Please contact authorized personnel from MDG to obtain written terms and conditions regarding product design and for such applications. Images are indicative only.

Peninsula Fireplaces

設置場所	Indoor & Outdoor
素材	Mild Steel (Zinc Sealed), Toughened Glass, Stainless Steel & Black Glass Charcoal as Decorative Media
色	■ Black *内蔵バーナーはStainless色となります。
燃料	e-NRG バイオエタノール

FLEX122

ESF.1.FX.122PN

価格	1,980,000円 (税別)
重量	145.8kg (内蔵バーナー、ガラス、石含む)
内蔵 Burner*	XL900 x 3
燃料タンク容量	9 Litres x 3
暖房の目安	180m ² 以上 (屋内使用時)
燃焼継続時間	約 8 - 13 hours
換気	1台あたり少なくとも 330m ³ 室内容積を確保して下さい

ESF.1.FX.122PN.BX2

価格	1,980,000円 (税別)
重量	152.1kg (内蔵バーナー、ガラス、石含む)
内蔵 Burner*	XL900 x 2
燃料タンク容量	9 Litres x 2
暖房の目安	120m ² 以上 (屋内使用時)
燃焼継続時間	約 8 - 13 hours
換気	1台あたり少なくとも 220m ³ 室内容積を確保して下さい

ESF.1.FX.122PN.BXL ESF.1.FX.122PN.BXR

価格	1,980,000円 (税別)
重量	176.2kg (内蔵バーナー、ガラス、石含む)
内蔵 Burner*	XL1200 x 2
燃料タンク容量	10 Litres x 2
暖房の目安	130m ² 以上 (屋内使用時)
燃焼継続時間	約 9 - 14 hours
換気	1台あたり少なくとも 230m ³ 室内容積を確保して下さい

バーナーのご使用前には必ず取扱説明書をお読みください。

*これらの値は参考値であり、購入したモデル、設置方法、設置環境およびe-NRGの製造時期等により異なります。

→
All models can be rotated

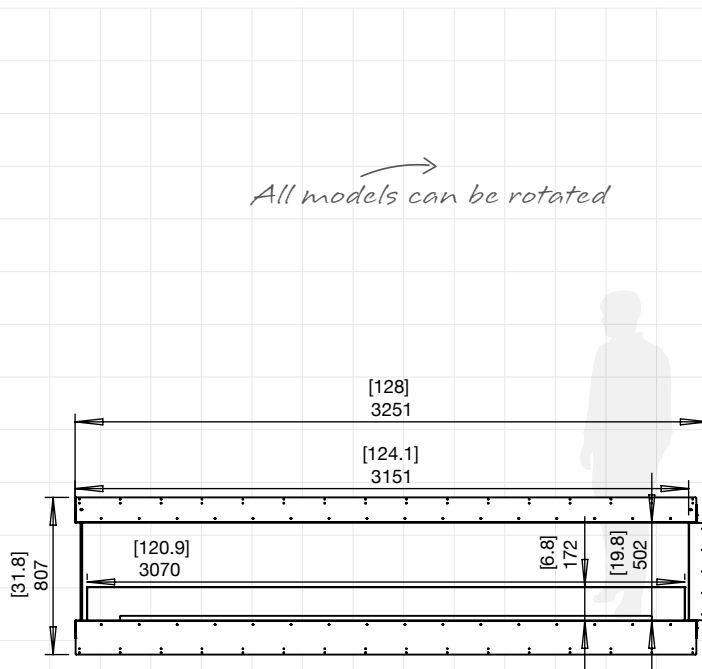

122PN (FLAME ONLY)

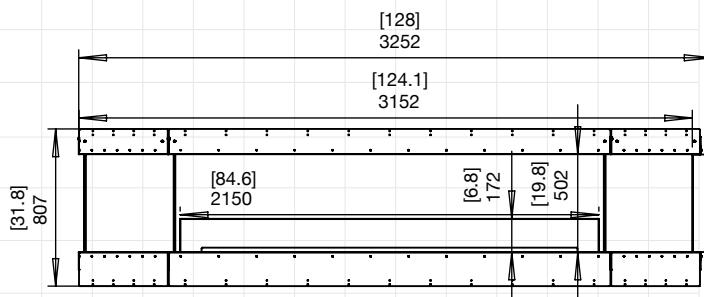

122PN.BX2 (LEFT & RIGHT DECORATIVE BOXES)

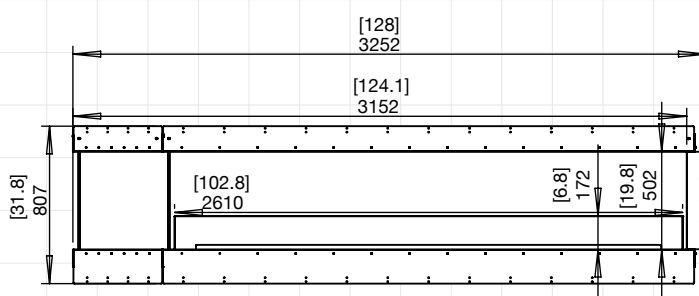

122PN.BXL (LEFT DECORATIVE BOX AS ILLUSTRATED)
122PN.BXR (RIGHT DECORATIVE BOX)

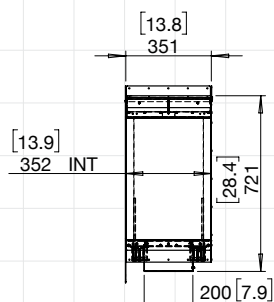

SIDE VIEW

FOR MORE INFORMATION PLEASE REFERENCE THE CLEARANCE & INSTALLATION MANUAL

Disclaimer: All product specifications and data are subject to change without notice and believed to be correct at the time of publication. MAD Design Group (MDG), its affiliates, agents and employees and all persons acting on its behalf collectively ("MAD Design Group") disclaim any and all liability for errors, inaccuracies or incompleteness contained herein or in any other disclosure relating to any product. MDG disclaims any and all liability arising out of the use or application of any product described herein or of any information provided herein to the maximum extent permitted by law. The product specifications do not expand or otherwise modify MDG's terms and conditions of purchase, including but not limited to the warranty expressed herein, which apply to these products. No license, express or implied, by estoppel or otherwise, to any intellectual property rights is granted by this document to any conductor of MDG. Customers using or selling MDG products not expressly indicated for use in such applications do so entirely at their own risk and agree to fully indemnify MDG for any damages arising or resulting from such use or sale. Please contact authorized personnel from MDG to obtain written terms and conditions regarding product design and for such applications. Images are indicative only.

Peninsula Fireplaces

設置場所	Indoor & Outdoor
素材	Mild Steel (Zinc Sealed), Toughened Glass, Stainless Steel & Black Glass Charcoal as Decorative Media
色	■ Black *内蔵バーナーはStainless色となります。
燃料	e-NRG バイオエタノール

FLEX140

ESF.1.FX.140PN.BX2

価格	2,200,000円 (税別)
重量	198.7kg (内蔵バーナー、ガラス、石含む)
内蔵 Burner*	XL1200 x 2
燃料タンク容量	10 Litres x 2
暖房の目安	130m ² 以上 (屋内使用時)
燃焼継続時間	約 9 - 14 hours
換気	1台あたり少なくとも 230m ³ 室内容積を確保して下さい

ESF.1.FX.140PN.BXL ESF.1.FX.140PN.BXR

価格	2,200,000円 (税別)
重量	170.6kg (内蔵バーナー、ガラス、石含む)
内蔵 Burner*	XL900 x 3
燃料タンク容量	9 Litres x 3
暖房の目安	180m ² 以上 (屋内使用時)
燃焼継続時間	約 8 - 13 hours
換気	1台あたり少なくとも 330m ³ 室内容積を確保して下さい

バーナーのご使用前には必ず取扱説明書をお読みください。

*これらの値は参考値であり、購入したモデル、設置方法、設置環境およびe-NRGの製造時期等により異なります。

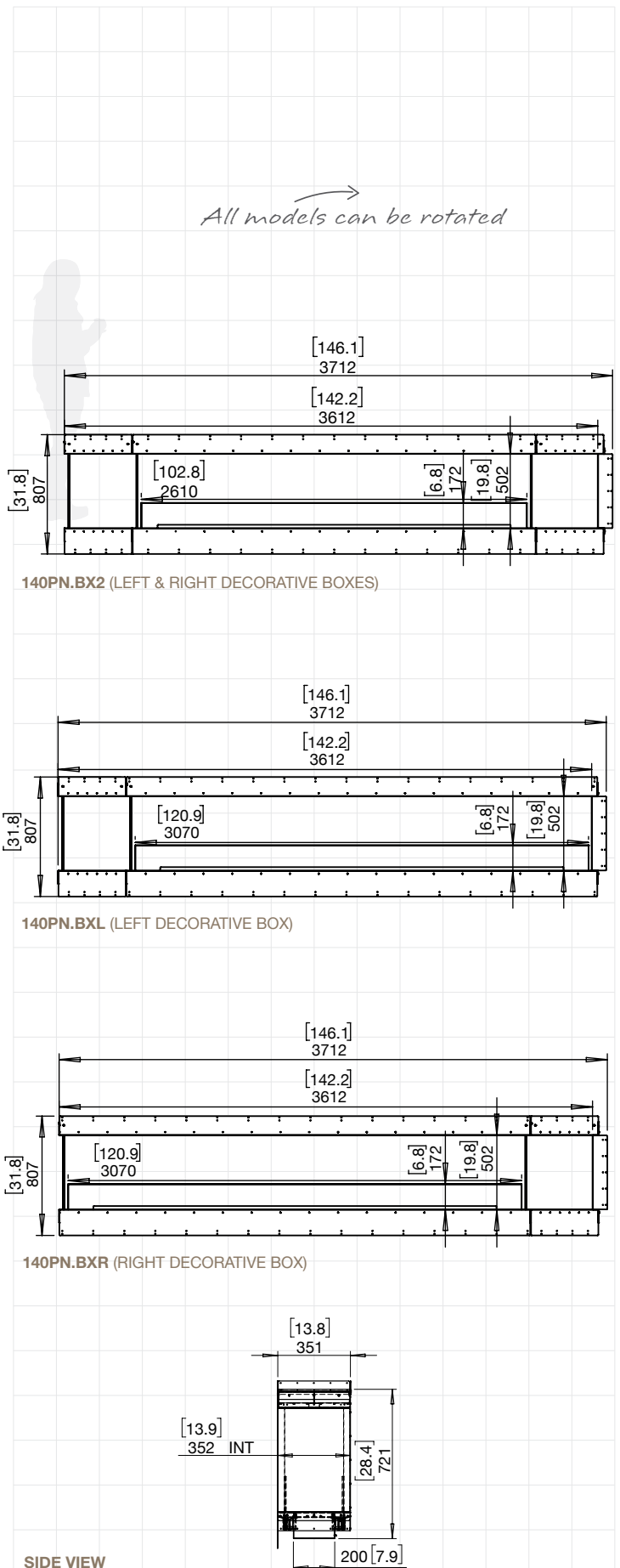

FOR MORE INFORMATION PLEASE REFERENCE THE CLEARANCE & INSTALLATION MANUAL

Disclaimer: All product specifications and data are subject to change without notice and believed to be correct at the time of publication. MAD Design Group (MDG), its affiliates, agents and employees and all persons acting on its behalf collectively ("MAD Design Group"), disclaim any and all liability for errors, inaccuracies or incompleteness contained herein or in any other disclosure relating to any product. MDG disclaims any and all liability arising out of the use or application of any product described herein or of any information provided herein to the maximum extent permitted by law. The product specifications do not expand or otherwise modify MDG's terms and conditions of purchase, including but not limited to the warranty expressed herein, which apply to these products. No license, express or implied, by estoppel or otherwise to any intellectual property rights is granted by this document to any product of MDG. Customers using or selling MDG products not expressly indicated for use in such applications do so entirely at their own risk and agree to fully indemnify MDG for any damages arising from such use or sale. Please contact authorized personnel from MDG to obtain written terms and conditions regarding product design for such applications. Images are indicative only.

Peninsula Fireplaces

設置場所	Indoor & Outdoor
素材	Mild Steel (Zinc Sealed), Toughened Glass, Stainless Steel & Black Glass Charcoal as Decorative Media
色	■ Black *内蔵バーナーはStainless色となります。
燃料	e-NRG バイオエタノール

FLEX158

ESF.1.FX.158PN

価格	2,500,000円 (税別)
重量	231.8kg (内蔵バーナー、ガラス、石含む)
内蔵 Burner*	XL1200 x 3
燃料タンク容量	10 Litres x 3
暖房の目安	195m ² 以上 (屋内使用時)
燃焼継続時間	約 9 - 14 hours
換気	1台あたり少なくとも 345m ³ 室内容積を確保して下さい

ESF.1.FX.158PN.BX2

価格	2,500,000円 (税別)
重量	195.4kg (内蔵バーナー、ガラス、石含む)
内蔵 Burner*	XL900 x 3
燃料タンク容量	9 Litres x 3
暖房の目安	180m ² 以上 (屋内使用時)
燃焼継続時間	約 8 - 13 hours
換気	1台あたり少なくとも 330m ³ 室内容積を確保して下さい

バーナーのご使用前には必ず取扱説明書をお読みください。

*これらの値は参考値であり、購入したモデル、設置方法、設置環境およびe-NRGの製造時期等により異なります。

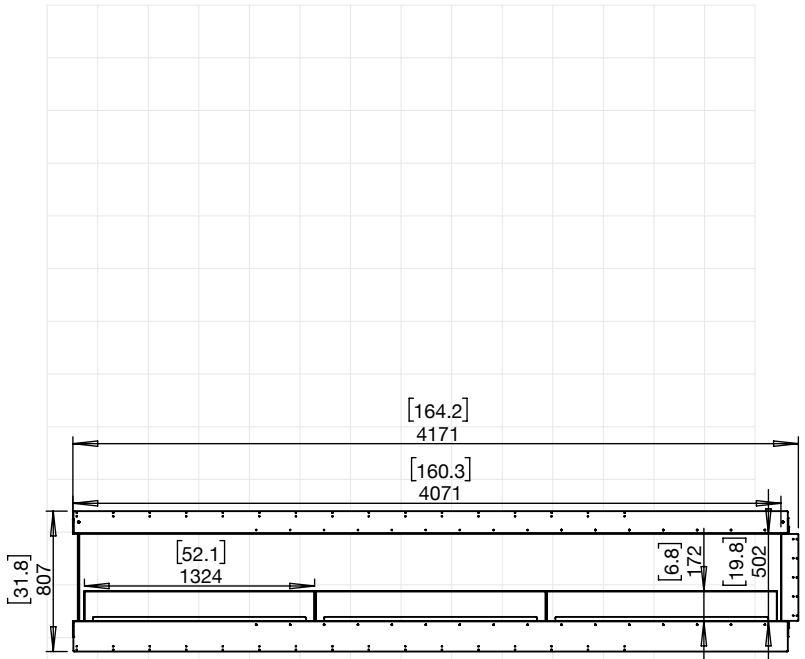

158PN (FLAME ONLY)

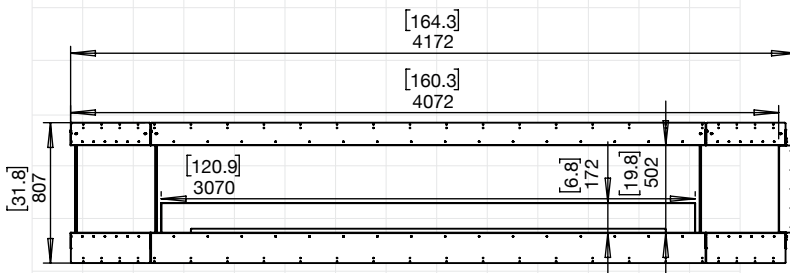

158PN.BX2 (LEFT & RIGHT DECORATIVE BOXES)

All models can be rotated

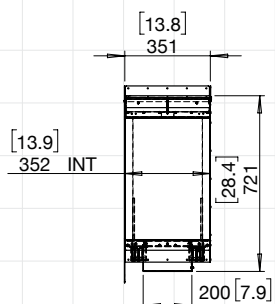

SIDE VIEW

FOR MORE INFORMATION PLEASE REFERENCE THE CLEARANCE & INSTALLATION MANUAL

Disclaimer: All product specifications and data are subject to change without notice and believed to be correct at the time of publication. MAD Design Group (MDG), its affiliates, agents and employees and all persons acting on its behalf (collectively, "MAD Design Group") disclaim any and all liability for any errors, inaccuracies or incompleteness contained herein or in any other disclosure relating to any product. MDG disclaims any and all liability arising out of the use or application of any product described herein or of any information provided herein to the maximum extent permitted by law. The product specifications do not expand or otherwise modify MDG's terms and conditions of purchase, including but not limited to the warranty expressed herein, which apply to these products. No license, express or implied, by estoppel or otherwise to any intellectual property rights is granted by this document to any product of MDG. Customers using or selling MDG products not expressly indicated for use in such applications do so entirely at their own risk and agree to fully indemnify MDG for any damages arising from such use or sale. Please contact authorized personnel from MDG to obtain written terms and conditions regarding products designed for such applications. Images are indicative only.

Peninsula Installations



FLEX18PN



FLEX68PN.BXL



FLEX140PN.BX2