

# ZUMA



Sound and Light. Reinvented.



**At Zuma we believe sound should be heard, not seen, that you should live in a wow home and not a technology showroom.**

Our quest is to transform our relationship with sound and light at home. Bring better, more immersive and enjoyable listening experiences to everyone, everywhere throughout your house.

To do this we had to re-imagine how we listen to sound. Listening to a single point source or a pair of loudspeakers in a room has never really been questioned.

What we wanted to create was the experience of being in the middle of a concert hall, or standing outside in a tropical rainforest. Our desire was for sound to envelop you.

To be bathed in sound and for it to be truly immersive you need multiple sound sources, as many as possible. However, our homes are already full of cables, crowded power sockets and convoluted devices and we didn't want to add to the clutter.

Our approach was to find a new, simple, cableless way to deliver hi-fidelity sound everywhere throughout the home. The ubiquitous down lights that you find in every room are ideally located to deliver true immersive sound everywhere.

So, we integrated a unique high performance loudspeaker with a premium fully dimmable colour tuneable light and the Zuma wireless multi-room system was born.





## Zuma is a light

Using optimal high performance Light Emitting Diodes (LED) that are energy friendly yet give excellent natural colour experience was a goal for us.

In collaboration with leading lighting industry experts we painstakingly developed a human centric down light solution that covers a wide range of natural lighting colours. With a colour rating index (CRI) 90 we are at the peak of colour rendering quality and natural lighting, and with our custom Circadian rhythm App feature the lighting instinctively matches the natural colour rhythm of the day, supporting your well being and your body's natural rhythm.



Simplicity Square Bezel



Simplicity Round Bezel







## When is a light not a light? When it is an entire lighting system

With over 100 increments of dimming the Zuma lighting system enables super smooth adjustments. Warm to cool light temperature ranges from 2800k to 4800k, and Zuma's Circadian mode automatically mirrors the intensity and colour temperature of natural light. Numerous international studies have shown that Circadian lighting can boost mood, energy levels, sleep patterns and general wellbeing. The Zuma App also has preset features that allow you to select lighting scenes or fine tune the light to suit your needs.



Circadian lighting supports human health by minimising the effect of artificial light on the human circadian rhythm.

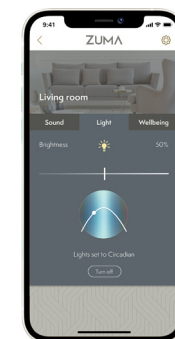

At a tap of a button our Zuma App allows you to set Circadian rhythm to run the right colour temperature dynamically throughout the day.





**Human Centric Lighting**  
In the morning, cool white light promotes the release of cortisol, providing an activating and concentration-enhancing effect. Warm white light in the evening stimulates the production of melatonin, which makes us relax and feel tired, in line with the body's biological processes.





**“A game changer in the way that we listen to music, watch films or simply relax.”** Forbes

The way we live our lives today means we lay, sit or stand when we listen to music or watch TV. With Zuma there is no sweet spot, the sound is all-around you. Connect your phone and play your favourite music service. Connect your TV streamer for instant home cinema. Use Alexa or the Zuma app to set the perfect sound and light to suit your mood and the occasion.

Ask to dim the lights, set the right colour temperature and enjoy your movie. No Sound-bar or subwoofer required, no unsightly cables, plugs and sockets, just a captivating and immersive soundscape.

Zuma's acoustic array has a constant high direct to reverb ratio, meaning the listener is near a constant distance approaching the near-field of the radiating speaker sources. This leads to an increase in the general comfort and intelligibility over the entire listening area compared to conventional paired speaker setups.



# The unique Zuma Lumisonic System

Under the bonnet is a next generation HD-audio Class D monolithic amplifier controlled by a best in class audio quad core processor with advanced DSP features. Each channel is actively filtered and managed by advanced DSP algorithms to maximise detail and performance so you can enjoy a truly immersive sound experience.

Our bespoke two-way speaker system incorporates a uniquely optimised long throw (20mm excursion) 3 inch super formed aluminium cone. Every aspect of the woofer design and enclosure has been tuned and refined to ensure that when paired with the unique electronics it delivers pace, rhythm and extraordinary detail.

At the centre of the Lumisonic design is our high performance horn loaded silk dome tweeter that has been developed with ultra wide dispersion for improved clarity and room coverage.

Wirelessly synchronised to support real room filling performance Zuma uses a custom wireless multi-room connectivity system that adapts to your environment automatically. This allows wire free immersive audio over an entire room with audio streaming best in class synchronisation (100uS).

**Planning for the future.** Inside each Zuma is a class leading central ARM processor, quad core CPU dedicated to delivering 1.4GHz of experience, intelligently managed to ensure the experience is unblemished. Every part of the product is software updatable giving you confidence that future needs and trends can be met.

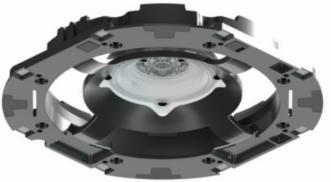
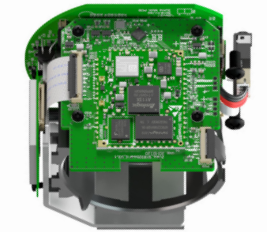

Precision machined aluminium extruded outer case works.

High performance monolithic Class D amplifier controlled by best in class central ARM processor, quad core CPU.

Patented super formed aluminium woofer drive unit with high performance radial neodymium magnet system.

Patented integrated high performance tweeter and LED array assembly.

Magnetically detachable acoustic bezel available in a range of geometry and design styles.



Our team understand how trends and demands evolve so we developed Smart Bezel™ enabling additional features such as temperature and motion sensors, microphones, cameras, security and smoke detectors.



**“Even a single unit sounds great, but when they’re installed in multiples the sweet spot vanishes and you’re bathed in glorious audio”** *Wired*

Zuma has been developed over many years by a world-renowned team led by industrial designer Morten Warren. Featuring world class acoustic engineers, Trevor Wilson (previously with Naim audio), Laurence Dickie – the creator of the iconic Nautilus loudspeaker (one of the finest examples of high-end audio engineering in history, according to What HiFi) and smart home industry leading CTO Alex Kiernan.

They have worked tirelessly with specialist engineering partners in the UK, Germany, Taiwan and North America to deliver an immersive experience that will forever change the way we perceive sound.



Morten Warren Industrial Design,  
Laurence Dickie Acoustic Engineering,  
Trevor Wilson Product Development  
and Alex Kiernan Chief Technology  
Officer.







## Wellbeing by Zuma

Today's bathrooms are a place to revive and relax. They provide a comforting space to unwind at the end of the day or get you moving on busy weekdays. The bathroom can provide an escape that can be effortlessly enhanced with human-centric lighting, a perfectly curated touch-free playlist and Wellness features that help you leave your stresses behind and sink into a world of relaxation. Simply select one of our presets for a curated blend of light and sound experiences to enhance your daily rituals and tasks.

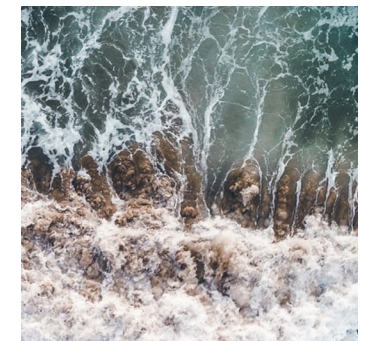
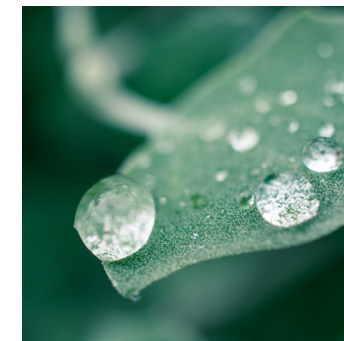
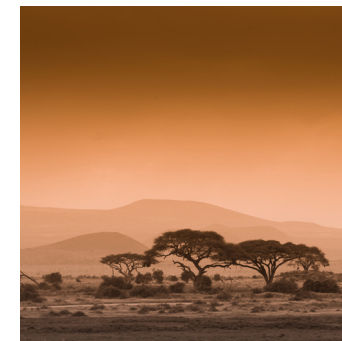

Immerse yourself with relaxing music in your bath, or take a shower under a tropical waterfall. Whether its to relax or unwind, or to excite and energize. With Zuma you can uniquely use a combination of sound and light to transform your home into a space that can ignite emotions and speak to your senses.

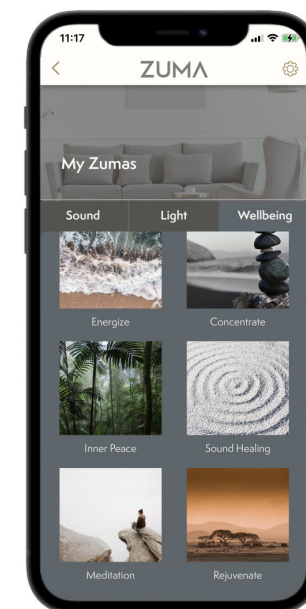

Zuma's App allows you to connect multiple zones in your home, quick easy access to internet radio and swift control over your lights, tone and colour balance. We also provide quick and convenient access to preset lighting scenes. Well-being features a range of atmospheres to suite your mood.

IP 65 Rated for bathrooms



## Zuma is well connected

Partnered for your convenience. Delivering great sounding products requires that we support the way you want to listen. Zuma supports and is certified to work with the majority of the solutions you need for listening. From Bluetooth to internet radio. From Airplay to Spotify and Alexa – pick your music streaming service and play. Linked to an Alexa Echo Dot (for example) to create a voice controlled light and sound solution that means you need only ask the room for your music and lights, Zuma does the rest.







**“The sound quality is hugely impressive, with a three-dimensional clarity and volume that is immersive and resonant.”** Wallpaper Magazine

The kitchen has become the heart of the modern home. Today it needs to deliver much more than just a space for cooking. Listening to music, watching TV, doing school-work and entertaining friends and family now constitute a significant proportion of time spent in this living space. Technology has a key role to play in optimising our enjoyment in the kitchen.

Zuma provides a fantastic addition to any kitchen project. Zuma declutters the space and brings hands free, wireless multi room audio and human centric lighting together in one super easy-to-install solution, allowing you to create the perfect atmosphere for any mood or occasion, without compromising on design.

Zuma works in multiple zones, the bedroom, living room, bathroom, kitchen, study, individually or connected all together to create an entire party house

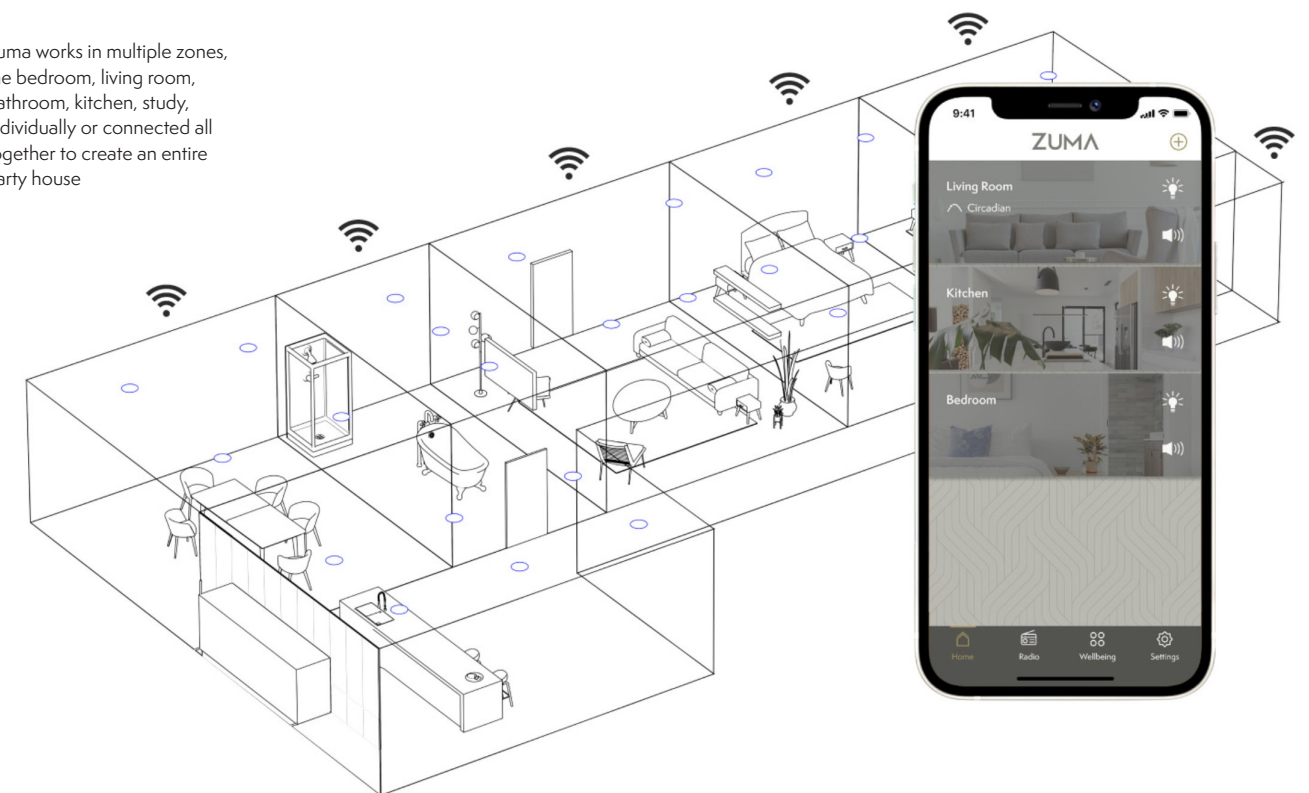



# Zuma is planning for the future

Zuma has been designed to be an expandable platform. Inside every Zuma Lumisonic is a class leading central processor providing the ability to add many new Smart Home features and functions through our patented Smart Bezel™ design.



**Current situation is costly and complex**  
Over 200 items requiring fittings, sockets, cables, wiring and batteries. With many man days disruption, installation and commissioning.

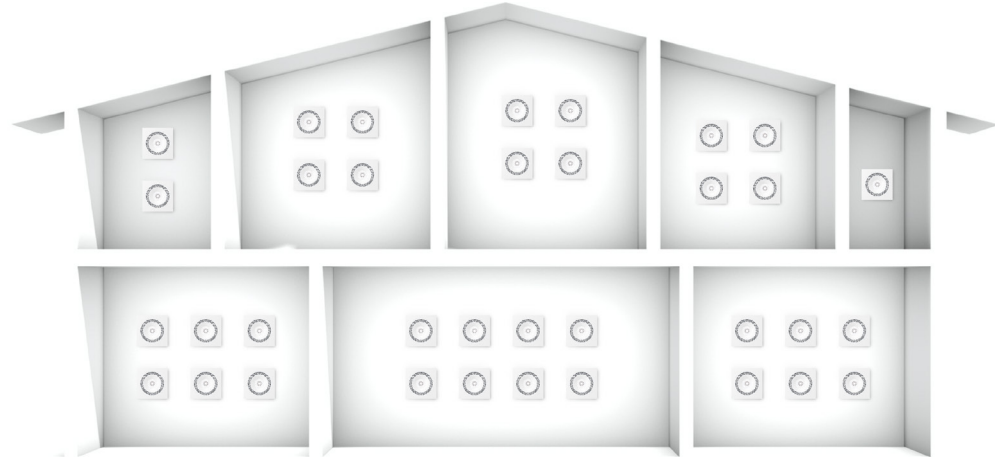

**Zuma is quick and simple**  
With Zuma it is 100x easier  
Minimal disruption  
Simple and easy to install an entire home







## Zuma fits seamlessly into your life

Say goodbye to lighting that is only on, off or occasionally dimmed. Zuma's combined lighting and sound let you energise yourself, set the right lighting intensity and turn up the volume to transform your home gym into a spin studio.



**Simplicity Square**  
Set a few millimetres proud of your ceiling



**Simplicity Square & trimless**  
Inset completely flush with your ceiling  
\*Additional frameless kits needed



**Simplicity Round**  
Set a few millimetres proud of your ceiling



**Simplicity Round & trimless**  
Inset completely flush with your ceiling  
\*Additional frameless kits needed

95mm / 3.75in Hole Cutout

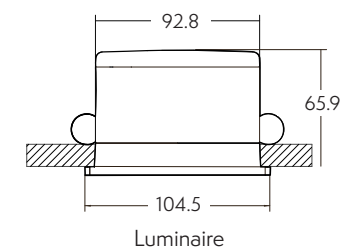
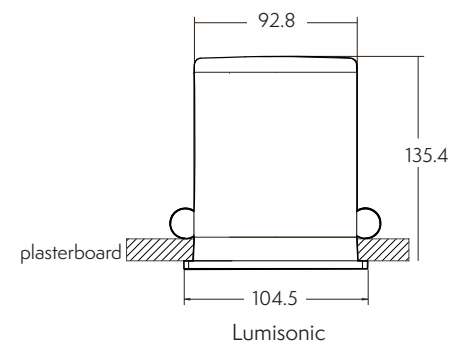



**“The killer feature of Zuma is that it can sit in a standard sized spotlight cavity and connect to the wiring for your lighting” T3**

Zuma sound and light is the smart home in one easy to install package. You can retrofit Zuma and even use your existing electric cables and light switches. Zuma will reinvigorate your environment when used in a refurbishment or if you are building a new home. Deceptively simple to install, 9.5 cm diameter downlight – with its trim-less design it discreetly blends into any interior and visually harmonises with any down light fixture.



**Easy installation and removal with Zuma's patented Blade System™.** Reduce the cost and time spent on fit out and commissioning. The Zuma Blade System™ minimises rework and risk of plaster damage and removes the need for complex integration and convoluted control systems.



Zuma's App allows you to play your favourite music and set your favourite lighting scene. Or use voice commands using our Alexa Smart-Bezel.







## How to buy

Zuma sound and light is only available directly from the Zuma website. This is our way of ensuring that we are always there for you with our in-depth experience and friendly advice. For help and to get the most from your Zumas, please visit [www.zuma.ai/help](http://www.zuma.ai/help) or email us at [help@zuma.ai](mailto:help@zuma.ai)

[www.zuma.ai](http://www.zuma.ai)



5 to 10 sqm

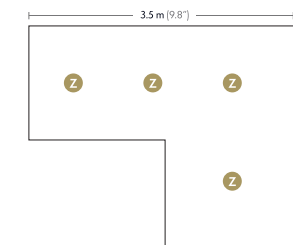

20 to 30 sqm

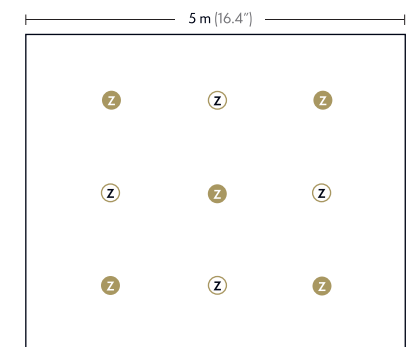

30 to 60 sqm

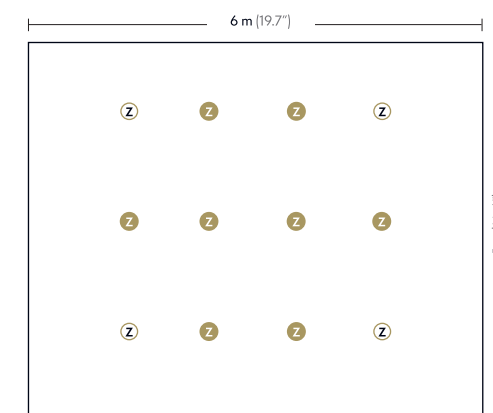

Examples of how Zuma can be used in a variety of spaces



Zuma Lumisonic      Zuma Luminaire

Two different Zuma units can be combined to create the desired effect for perfect light and sound. **Zuma Lumisonic** produces sound as well as light while the **Zuma Luminaire** is light only



# Specifications

## Sound

- Built-in class D Monolithic power amplifier in each Lumisonic:
- Watts: 75W
- Quad core 1.5GHz ARM Cortex-53 CPU
- Digital signal processor
- 80mm high excursion super formed aluminium woofer unit
- 20mm Horn loaded silk dome tweeter module.
- Frequency range: 40Hz-25kHz (-6db points)
- Audio streaming best in class synchronisation (100uS)
- Lossless audio format support up to 24 bit/192kHz
- Dynamic bass management

## Features

- Control: Zuma mobile app, and by voice with Alexa
- Multi-room audio: Yes with Alexa and AirPlay 2
- Connectivity: Wi-Fi, Bluetooth, Alexa, AirPlay 2, Spotify Connect
- Software updates: Wirelessly via the Zuma app
- Dynamic left and right stereo and mono control
- Network Wi-Fi dual band (WLAN 802.11a/b/g/n/ac, 2.4 and 5 GHz) 10/100 Mbps
- 10/100 Mbps Micro Ethernet port (via adaptor available separately)
- IPv4 and IPv6 support

## Light

- Light: Colour tuneable and dimmable light with 100 shades
- Application: Ceiling recessed, available as proud, or flush mount
- Light source: LED Chips
- Beam angle: 52° Wide spread
- Watt: 6W
- Lumen: 536lm
- Voltage: 24V constant voltage
- Colour temperature range: 2800k – 4800k
- Efficacy: 89lm/W
- CRI: 90+
- SDCM: <3
- Drivers available for: Lutron, Crestron, Control 4

## Design

- Dimensions: Ø94mm x 120mm deep,
- Square Face bezel: 104.5mm x 104.5mm x 4mm deep
- Materials: laser etched aluminium extrusion, aluminium die casting
- Stainless steel laser cut custom design grill
- Magnetically attached ABS injection moulded bezel
- Stainless steel quick release, damage free, ceiling blade fixtures

## Summary

- Warranty 3 Years
- Electrical and environmental performance
- Operational temperature: 0C to 40C
- Operational humidity range: 10% to max 90%
- UV degradation: No degradation to UV for 3 years.
- Switch mode power supply 230V, 50/60Hz AC with DC 24V/3.1 constant voltage power supply
- Proprietary wireless link between devices for audio synchronisation.
- IP 65 Rated

### Mid Power Chip LED

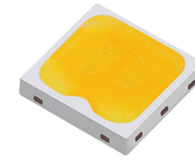

L80 > 54,000hr  
 Ta: 25°C  
 Tc: 85°C  
 Lm Maintainance: 98%  
 Chromaticity Shi : 0.0012  
 (Source: LM80 test report)

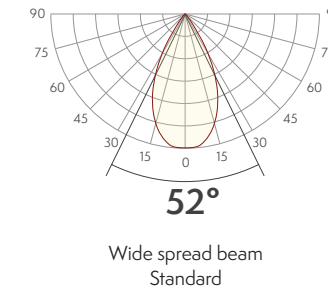
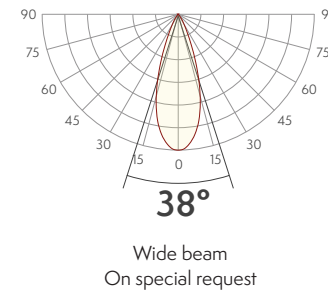
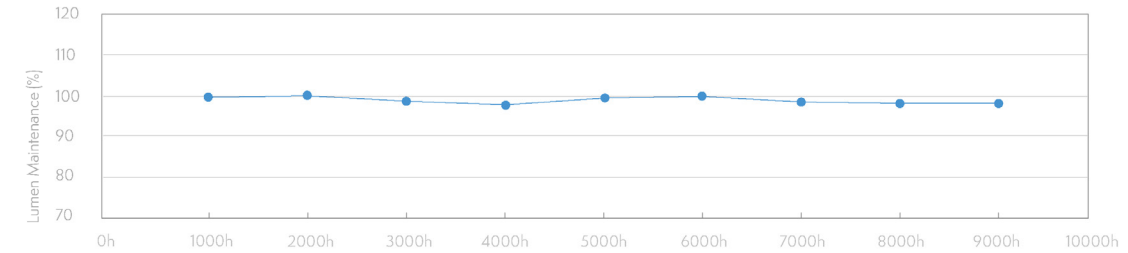
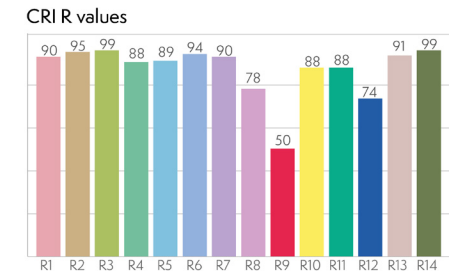
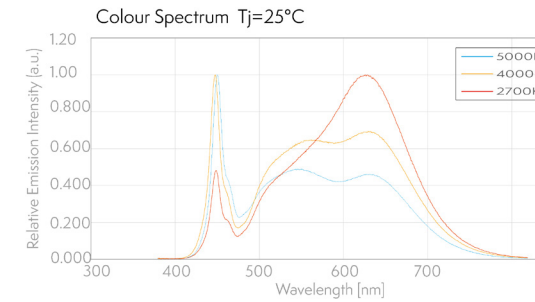
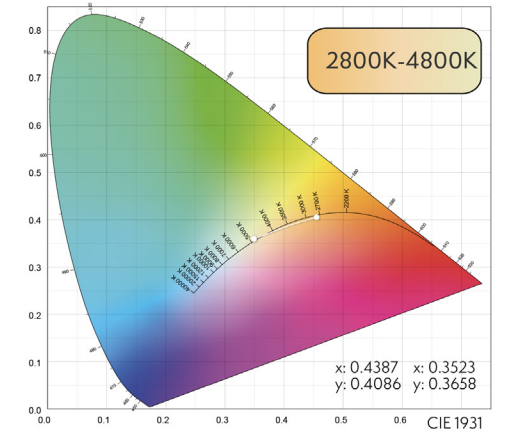

### Product versions and dimensions

Bezel Round Ø113mm  
 Bezel Square 104.5mm  
 Ceiling cutout Ø96mm  
 Minimum internal recess depth 125mm



Simplicity Square



Simplicity Round

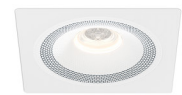

Simplicity Square Trimless



Simplicity Round Trimless

### Product finishes and bezel types

Bezel types: Available with round and square bezels in original white or white/polished stainless steel mesh  
 Trimless bezel: Available with separate mounting kit.  
 Round and square bezels in original white or white/polished stainless steel mesh



Super Nova White Round



Super Nova White Round Trimless



Super Nova Black Round



Super Nova Black Round Trimless



# ZUMA

