

Bowers & Wilkins

CDA-4D
Distribution
Amplifier

Welcome to Bowers & Wilkins and CDA-4D

Thank you for choosing Bowers & Wilkins. When John Bowers first established our company, he did so in the belief that imaginative design, innovative engineering and advanced technology were keys that could unlock the enjoyment of audio in the home. His belief is one that we continue to share and inspires every product we design, tailored for new audio experiences inside of the home.

CDA-4D distribution power amplifier can drive any Bowers & Wilkins custom installation speaker to new heights of performance. Offering 4 channels of high quality amplification, the CDA-4D can enable your home with sound yet takes up minimal space thanks to its compact 1U design. CDA-4D configuration also supports bridging of its Class D stereo channels into even more powerful mono outputs, if needed. CDA-4D can be easily setup via the Product Configuration page which allows customisable complex DSP tuning, offering wider flexibility and integration offering to your installation.

Features

- 4 channel amplification in 2 zones with 125 watts per channel delivering high-resolution audio.
- Engineered to work with Bowers & Wilkins installation speakers and subwoofers.
- Highly flexible usage / configuration – Left/Right outputs can be bridged to provide a mono output of double the power at 250 watts.
- Three power mode control options – on, auto detect or 12V trigger.
- Robust and reliable protection features, preventing damage due to overload, short circuits or heat.
- Ultra-compact rack-mount design (1 rack unit).
- Product Configuration page allows customisable setup for various use case configuration.
- Audio Video Bridging (AVB) compatible*.

Note: Always check for the latest software on the Bower & Wilkins website.

*AVB is available when two or more Bowers & Wilkins CDA amplifiers (CDA-2HD or CDA-4D) are connected to the same wired network using AVB enabled network hardware (AVB enabled switch). Analogue or digital input sources from other CDA amplifiers can be selected as an input source.

AVB is a set of standards whose implementation varies from manufacturer to manufacturer. As such we cannot guarantee AVB compatibility between Bowers and Wilkins devices and other equipment or network hardware.

CLASS 2 WIRING
CÂBLAGE DE CLASSE 2

 Connecting speaker wires or input cables while the amplifier is powered may cause electrical shock and could damage the amplifier. Unplug the power cord before making connections.

 Connecter tous câbles d'entree ou de sortie alors que l'amplificateur est sous tension peut provoquer un choc électrique et endommager l'amplificateur. Débranchez le cordon d'alimentation avant d'effectuer les connexions.

 Unit fuses may only be changed by skilled personnel - fuse may be in the neutral, mains should be disconnected to de-energize the phase conductor.

 Les fusibles de l'appareil ne peuvent être changé par du personnel qualifié uniquement fusible peut-être au neutre, le secteur doit être déconnecté pour mettre hors tension le conducteur de phase.

1. CDA-4D Carton Contents

- a. 1 x CDA-4D
- b. 2 x Rack-mount ears
- c. 4 x Feet
- d. 1 x Power cable
- e. 4 x Rack-mount ear screws (M5 x 8mm)
- f. 4 x Feet screws (M4 x 6mm)
- g. 2 x 5.08mm Pitch 4-way Phoenix Combicon style

Diagram 1. Carton Contents

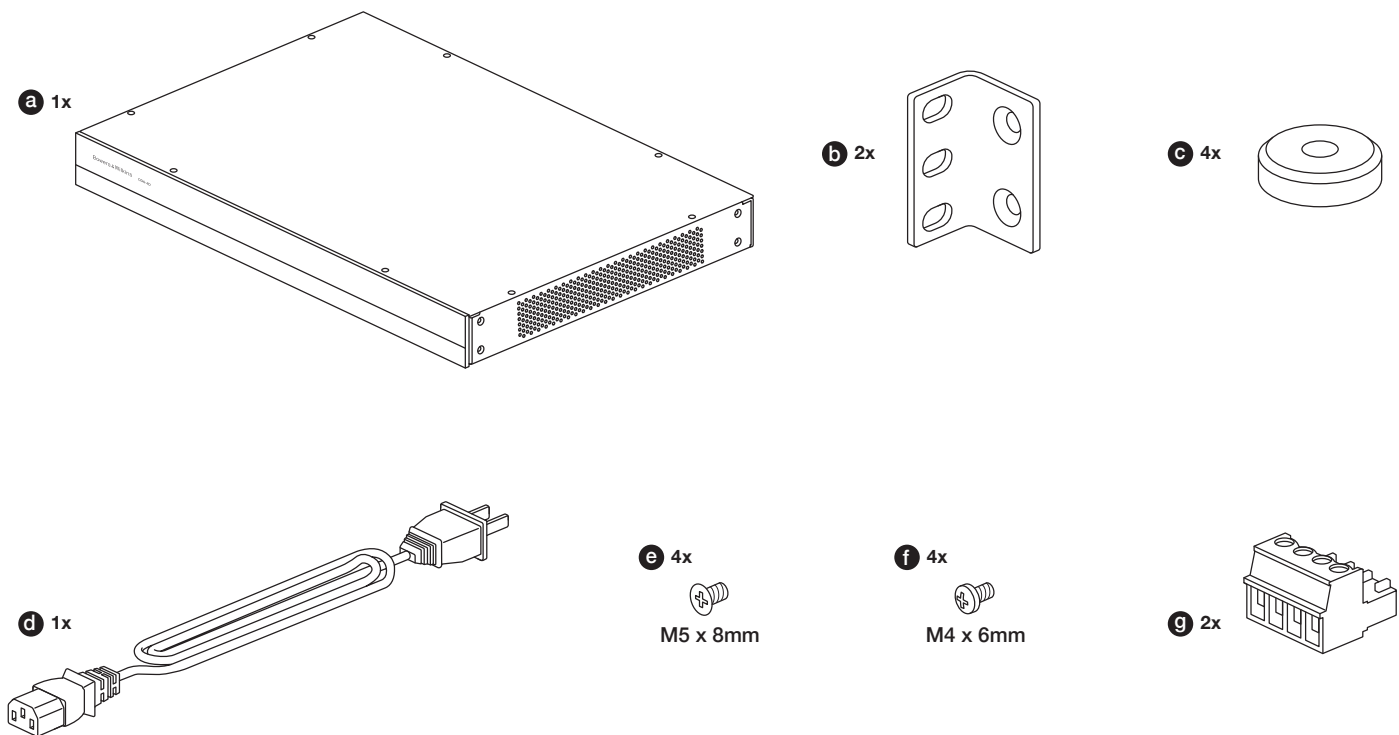

2. Installation

2.1 Rack mounting

CDA-4D is intended to be installed in a standard 19-inch equipment rack. It is supplied with rack mount ears, but not rack mount bolts and nuts. Ensure that, once mounted in the rack, the amplifier is well ventilated and that the ventilation apertures are not obstructed. If the system is taken out of use for a long period, disconnect the amplifier from the mains power supply.

The CDA-4D is supplied with two rack mounting ears for installation in standard equipment racks. Attach the brackets by inserting machine screws through each bracket into the threaded holes in the side of the amplifier, **see Diagram 2.**

Diagram 2. Rack mounting

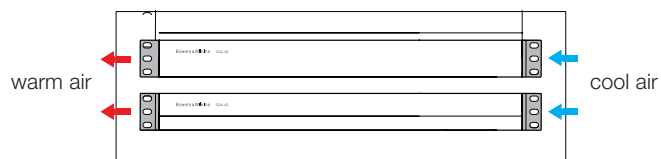
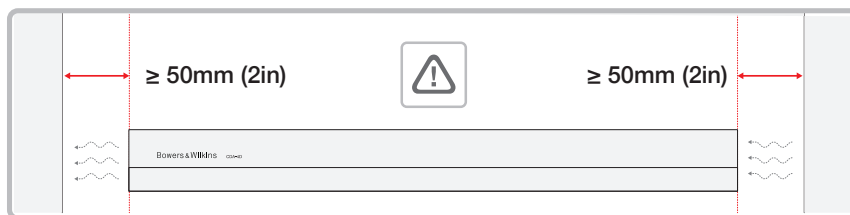
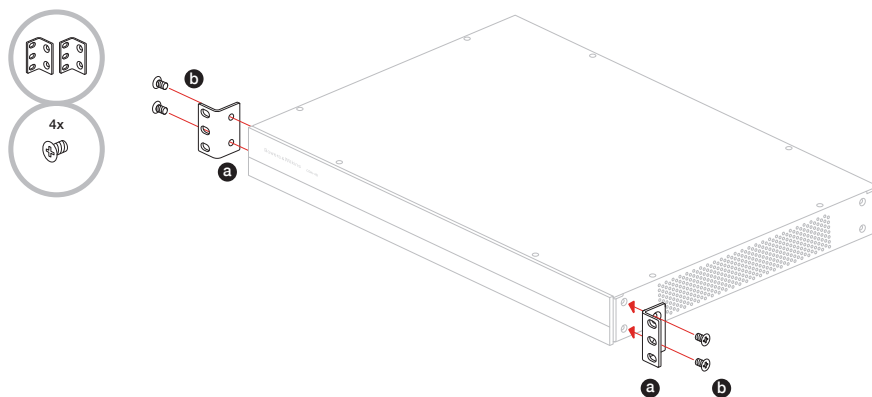

2.2 Foot mounting

CDA-4D can also be table mounted and is supplied with feet and feet screws, see **Diagram 3**.

Ensure that, once positioned, the amplifier is well ventilated and that the ventilation apertures are not obstructed. If the system is taken out of use for a long period, disconnect the amplifier from the mains power supply.

 To prevent damage, maintain adequate ventilation space to the sides of the amplifier. CDA-4D can be stacked vertically but be sure not to place the amplifier next to other components, or against the side of a cabinet. Doing so will block ventilation openings.

3. Controls and Connections

Rear panel sockets and switches, see **Diagram 4**.

1. Power input socket (IEC C14)
2. Output
3. Reset button
4. Ethernet (RJ45) socket
5. 12V trigger in / out
6. Digital inputs
7. Analogue inputs

Front panel controls, see **Diagram 5**.

1. Power LED
2. Ethernet LED
3. Zone status LEDs

3.1 Reset Button

 Using the factory reset can erase all setting and revert the amplifier back to the factory flashed firmware.

Reboot

This allows the device to gracefully shut down and restart.

- a. Single press of the reset button - The LED will flash green while rebooting

Reset

This will reset all settings and all saved presets.

- a. Press and hold the reset button for 5 seconds until the LED starts flashing green.
- b. Release the button and wait for the device to restart.

Note: Reboot and Reset can also be achieved via the Product Configuration Page, see section 7.1.6 Settings Management

Factory Reset

This will reset all settings, all saved presets and device firmware to its original factory settings.

- a. Make sure the unit is turned off using the AC power inlet switch.
- b. Press and hold the reset button and turn the AC power inlet switch on – keep pressed for 10 seconds until the LED starts flashing green.
- c. Release the reset button and wait for the device to restart.

Diagram 3. Foot mounting

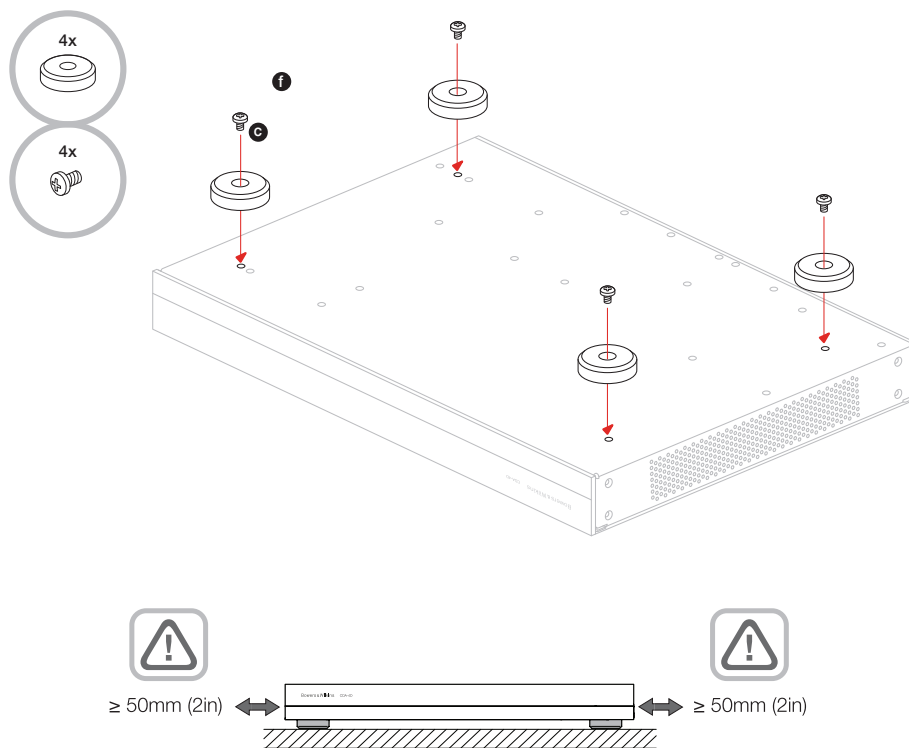

Diagram 4. Rear panel

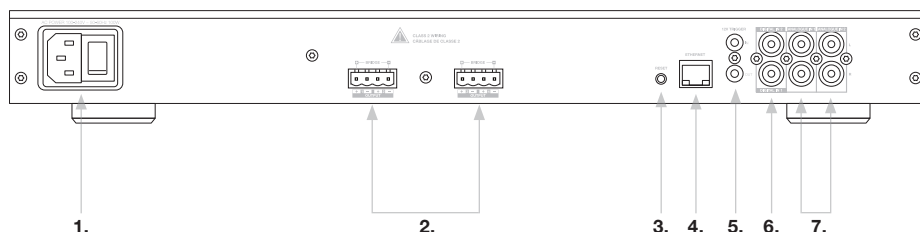
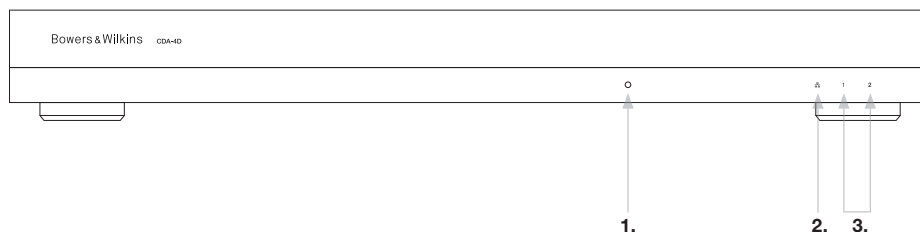



Diagram 5. Front panel



4. Connecting

 Connecting speaker wires or input cables while the amplifier is powered may cause electrical shock and could damage the amplifier. Unplug the power cord before making connections.

4.1 Connecting from source

There are three options when connecting audio inputs to the CDA-4D distribution amplifier.

Ethernet (network connection)

 Network connection is mandatory for setup and configuration. See section 6 Network Connection Instruction.

Audio Video Bridging (AVB) connection

Used to make connection to a wired network. Once Connected, the amplifier will become visible on the network to other Bowers & Wilkins CDA devices. see **Diagram 6**.

Refer to section 7.2.1 on how to setup your amplifier.

Analogue Input

Primary Analogue Inputs 1L, 1R:
Use these inputs for primary audio source.

Secondary Analogue Inputs 2L, 2R:
Use these inputs for a secondary audio source. see **Diagram 7**.

Digital Input

Primary Digital Inputs 1:
Use these inputs for primary Digital Audio Source.

Secondary Digital Inputs 2:
Use these inputs for a secondary digital audio source. see **Diagram 8**.

Diagram 6. Connecting to network

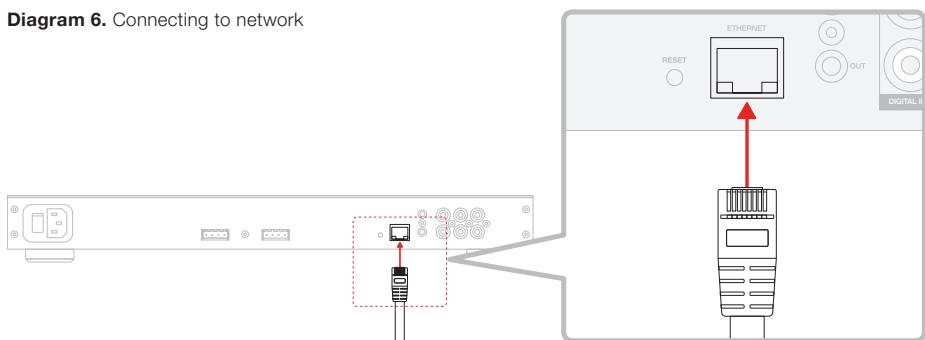

Diagram 7. Connecting from Analogue source

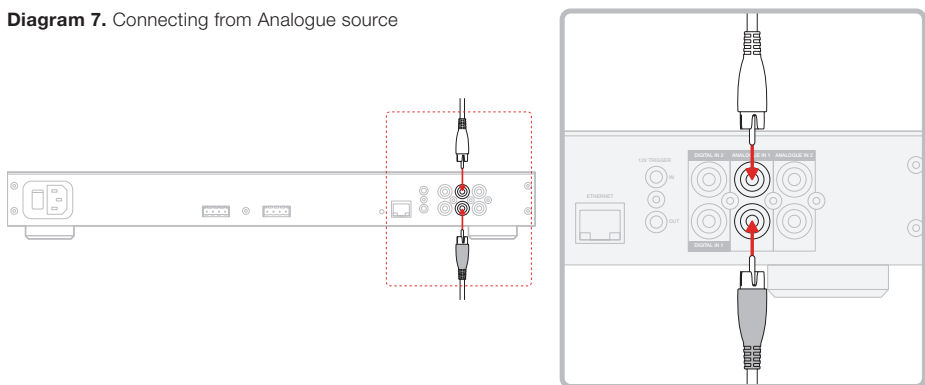
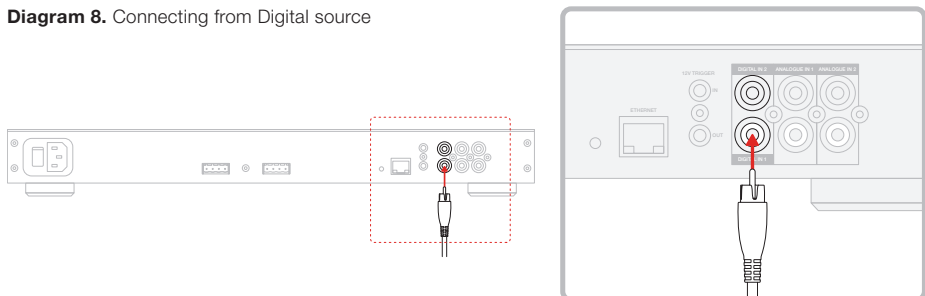

Diagram 8. Connecting from Digital source





4.2 Connecting to speakers

CDA-4D can power two stereo output of audio and has phoenix-style terminal blocks for speaker connections. Speakers can also be wired to bridge channels to increase the power available to the speakers.

To connect stereo speakers:

1. Connect speaker cable to the phoenix connector and reinsert into the amplifier, **see Diagram 9.**

 The common signal of these speaker outputs must not be connected together or to any other common signal. Do not connect the 1 - and 2 - (negative) terminals together. Doing so will result in a fault condition and the amplifier will either shut down or not work properly.

 Check the polarity of the speakers and wires before connecting to the amplifier.

To connect bridged-tied load speakers, **see Diagram 10:**

1. Select BRIDGE-TIED LOAD in the Product Configuration Page.
2. Connect + terminal from the speaker to the + terminal of the right channel (R).
3. Connect the - terminal from the speaker to the - terminal of the left channel (L) on the amplifier.

The two terminals for a bridged pair of speakers area marked by + BRIDGE -.

In bridge mode both amplifiers in the zone combine to make a mono output of double the power.

 The minimum load impedance in bridge mode is 8Ω. Connecting 4Ω loads may result in lower output power, distortion and overheating.

Diagram 9. Connecting to speakers



MODE OF USE

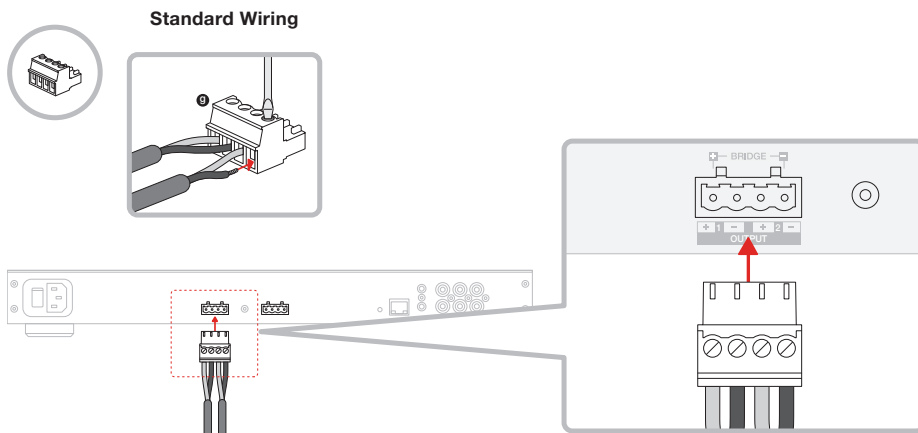

OUTPUT SETUP

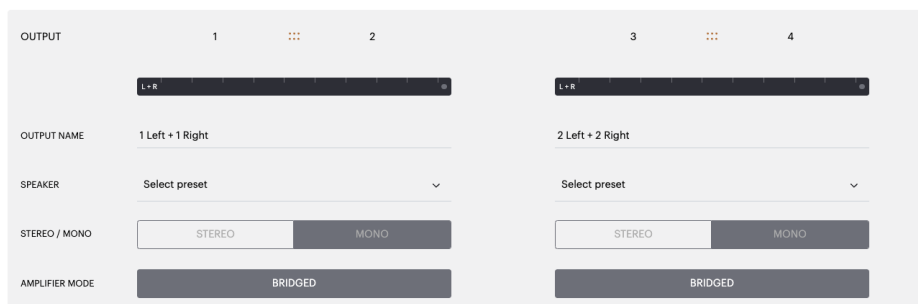

Diagram 10. Connecting to Bridged-Tied Load speakers

Bridge-Tied Load Wiring



5. Setting POWER MODE

CDA-4D can be set up to automatically power on when needed. The POWER MODE can be selected via the Product Configuration Page, allowing the CDA-4D to be powered on at all times when POWER MODE is set to ON. The CDA-4D can also be turned on when an audio signal is present at any audio input by selecting AUTO DETECT or the 12V TRIGGER.

To set up CDA-4D to be controlled by a 12V trigger:

1. Connect the 12V trigger cable to the 3.5mm 12V TRIGGER IN socket, see **Diagram 11**. Ensure a 12V signal is present.
2. Select 12V TRIGGER in the POWER MODE settings
3. (Optional) Connect the 12V TRIGGER OUT socket to a 12V TRIGGER IN on another amplifier to link the power control together

In this mode, CDA-4D will turn on when a 12V signal is present on the 12V Trigger Input. This 12V trigger input can be wired to the 12V trigger output from an audio matrix switch or a relay.

Note: All amplifier zones turn on when a 12V trigger is received in 12V TRIGGER MODE.

6. Network Connection Instruction

6.1 Connecting to your Product Configuration Page

1. The amplifier's factory default settings has DHCP set to ON.
2. Connect the amplifier to a network with a router using a RJ-45 cable. Make sure the computer / tablet and amplifier are on the same network.
3. Turn on the amplifier.
4. Open a web browser
5. Enter the CDA-4D default network address [product name]+[serial number] for example: http://cda-4d_XXXX-xxxxxxx.local in the browser address field and press "return". This will open the Product Configuration Page.

Alternatively, all network IP addresses will be accessible from your Router configuration page.

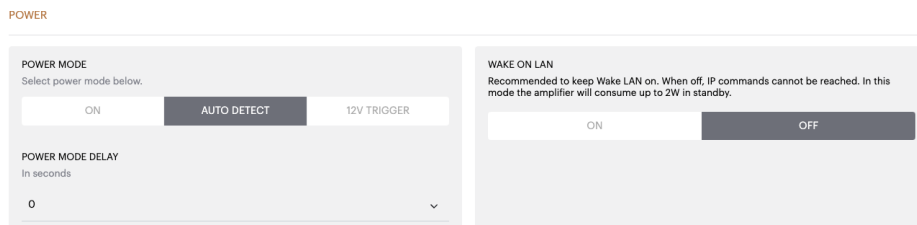

Diagram 11. 12V Trigger

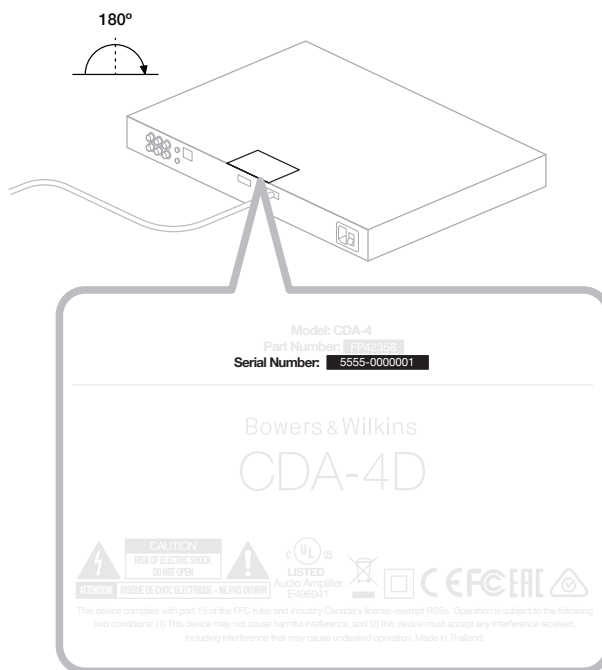

Diagram 12. Product label - Serial Number



7. Configuring your Amplifier (via Product Configuration Page)

7.1 Basic Settings

In the Basic Settings tab, users can edit general amplifier settings. The following section will take you through each of the functions on this tab.

7.1.1 Information

In this section, the user can add a name for the CDA-4D amplifier and enter the installation details. The amplifier model, Firmware version, serial number, temperature and time/date are displayed here, they are non-editable.

Bowers & Wilkins

BASIC SETTINGS INPUT/OUTPUT SETTINGS DSP CONFIGURATION

INFORMATION

AMPLIFIER NAME <i>Enter the amplifier name (up to 140 chr)</i>	CUSTOMER NAME <i>Enter the Customer's full name (up to 140 chr)</i>	FIRMWARE VERSION 0.0.3.73
AMPLIFIER MODEL CDA-4D	DEALER NAME <i>Enter the name of the Dealer (up to 140 chr)</i>	SERIAL NUMBER 2237-0500009
IDENTIFICATION MODE When switched on the front power LED will start flashing.	INSTALLER NAME <i>Enter the name of the installer (up to 140 chr)</i>	CURRENT TEMPERATURE 35°C 95°F
<input type="checkbox"/> ON <input checked="" type="checkbox"/> OFF	INSTALLATION DATE 01/01/2022	CURRENT DATE 25 / 11 / 2022
		CURRENT TIME 10:08 UTC + 0

NETWORK

DHCP Any additional information.	GATEWAY 192.168.1.1
<input checked="" type="checkbox"/> ON <input type="checkbox"/> OFF	PREFERRED DNS SERVER 0.0.0.0
IP ADDRESS 192.168.1.110	ALTERNATIVE DNS SERVER 0.0.0.0
SUBNET MASK 255.255.255.0	<input type="button" value="SAVE NETWORK DETAILS"/>

POWER

POWER MODE Select power mode below.	WAKE ON LAN Recommended to keep Wake LAN on. When off, IP commands cannot be reached. In this mode the amplifier will consume up to 2W in standby.
<input type="checkbox"/> ON <input checked="" type="checkbox"/> AUTO DETECT <input type="checkbox"/> 12V TRIGGER	<input type="checkbox"/> ON <input checked="" type="checkbox"/> OFF
POWER MODE DELAY In seconds	
0	

NOTIFICATIONS

ENABLE EMAIL ALERTS <input checked="" type="checkbox"/> ON <input type="checkbox"/> OFF	ENABLE EMAIL ALERTS <i>Enter email address</i>	TEST EMAIL <input type="button" value="SEND TEST EMAIL"/>
When temperature exceeds 84 °C <input type="checkbox"/>	When volume exceeds 100 % <input type="checkbox"/>	When device loses network connection. <input type="checkbox"/>

SETTINGS MANAGEMENT

IMPORT SETTINGS Import saved setting to a location on your computer.	LOCK SETTINGS Set a pin to lock settings to prevent further changes. Use this PIN to unlock settings.	REBOOT Device will be unavailable briefly while it reboots.
<input type="button" value="IMPORT/RESTORE"/>	<input checked="" type="checkbox"/> Settings unlocked	<input type="button" value="REBOOT"/>
EXPORT SETTINGS Export setting to a location on your computer.	PRINT SETTINGS Print all settings.	RESET Device will reset all user settings to default. The firmware version will remain the same.
<input type="button" value="EXPORT"/>	<input type="button" value="PRINT"/>	<input type="button" value="RESET"/>
FIRMWARE UPDATE Update your firmware version with the latest update by uploading the latest firmware file.		
<input type="button" value="UPDATE FIRMWARE"/>		

7.1.2 Identification Mode

When this option is switched ON the front power LED will start flashing (White) to indicate which amplifier you are programming.

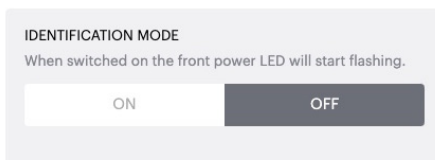

7.1.3 Network

DHCP ON / OFF

CDA-4D's factory default setting has DHCP (Dynamic Host Connection Protocol) set to ON.

DHCP shows the current IP address used when DHCP is ON. When DHCP is set to OFF this allows you to enter a desired static IP address.

 If changing the IP address or the Subnet Mask, the new IP address will need to be entered into the web browser to see the amplifier's web portal settings again.

NETWORK

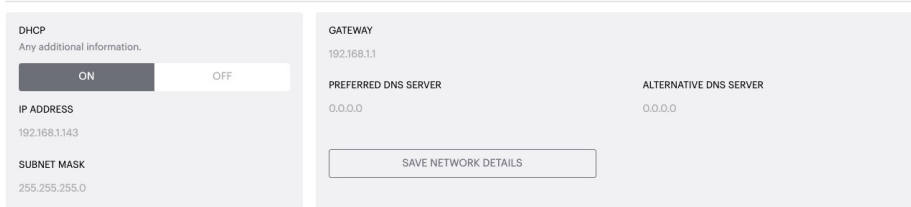

7.1.4 Power Mode

In this section, the user can select from a selection of POWER MODE options.

Note: When an audio signal has not been present on a channel for 15 minutes, the amplifier will go into Standby mode.

POWER

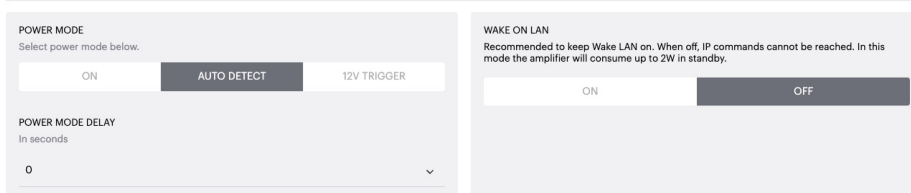

CDA-4D's factory default setting is set to Auto Detect.

ON

In this mode, signal sense and 12V Trigger are turned off. The amplifier will always stay on.

AUTO DETECT

This mode uses signal sense to turn the amplifier on.

12V TRIGGER

In this mode, the amplifier will turn on when a 12V signal is detected, and turn off when not.

 During setup it is strongly recommended that you keep the POWER MODE method set to ON to prevent the amplifier from shutting off.

Auto On Delay

The amplifier can be set from 0-20 seconds, this is useful when you want a series of amplifiers to switch ON in a specific sequence.

Wake On Lan

This allows the amplifier to be powered on or awakened from standby, from another device on a network.

 Recommend keeping Wake on Lan switched ON. When OFF, IP commands will not be available.

Power Mode	Power in standby Mode	Network Communication in Standby Mode
On	N/A	N/A
Auto Detect with Wake on Lan OFF	0.5W	NO
12V Trigger with Wake on Lan OFF	0.5W	NO
Auto Detect with Wake on Lan ON	0.5W	YES
12V Trigger with Wake on Lan ON	0.5W	YES

Control Systems

Wake on Lan must be enabled to control the unit via a control system.



Only one active connection to the unit will be available at any given point. We recommend setting up and tuning the unit via the web portal before connecting to a control system. The control system will need to be switched off before connecting to the unit via the web portal again.

7.1.5 Notifications

In this section, the user can turn ON notification and select notification alerts from the list. An alert notification will be sent to your desired email address when the selected alerts are triggered.

7.1.6 Settings Management

Import / Restore and Export Settings

The Import / Restore and Export button allows you to import, and export saved settings from a location from your computer. This can be very useful when setting up multiple amplifiers.

Update Firmware

The Update Firmware button will allow user to attach a .bin file to install firmware. The latest firmware will be available for download on our website: www.bowerswilkins.com

Lock Settings

When LOCKED, changes cannot be made on the device configuration page.

Print

The PRINT button will output a complete list of all settings for the amplifier.

Reboot

The REBOOT button allows the device to gracefully shut down and restart.

Reset

The RESET button will reset all settings and all saved presets.

NOTIFICATIONS

ENABLE EMAIL ALERTS <input checked="" type="checkbox"/> ON <input type="checkbox"/> OFF	ENABLE EMAIL ALERTS Enter email address <input type="text"/>	TEST EMAIL <input type="button" value="SEND TEST EMAIL"/>
When temperature exceeds 84 °C <input type="checkbox"/>	When volume exceeds 100 % <input type="checkbox"/>	When device loses network connection. <input type="checkbox"/>

SETTINGS MANAGEMENT

IMPORT SETTINGS Import saved setting to a location on your computer. <input type="button" value="IMPORT/RESTORE"/>	LOCK SETTINGS Set a pin to lock settings to prevent further changes. Use this PIN to unlock settings. Settings unlocked <input type="checkbox"/>	REBOOT Device will be unavailable briefly while it reboots. <input type="button" value="REBOOT"/>
EXPORT SETTINGS Export setting to a location on your computer. <input type="button" value="EXPORT"/>	PRINT SETTINGS Print all settings. <input type="button" value="PRINT"/>	RESET Device will reset all user settings to default. The firmware version will remain the same. <input type="button" value="RESET"/>
FIRMWARE UPDATE Update your firmware version with the latest update by uploading the latest firmware file. <input type="button" value="UPDATE FIRMWARE"/>		

7.2 Input / Output Settings

In the Input / Output Settings tab, configuration of the routing for each input to a selected output can be made here. Mode of use, individual trim level and volume parameters can also be set.

Bowers & Wilkins

BASIC SETTINGS **INPUT/OUTPUT SETTINGS** DSP CONFIGURATION

INPUT SOURCE SETUP

	1 LEFT		1 RIGHT		2 LEFT		2 RIGHT	
	L		R		L		R	
INPUT SOURCE	Analogue 1		Analogue 1		Analogue 2		Analogue 2	
INPUT NAME	Analog 1 Left		Analog 1 Right		Analog 2 Left		Analog 2 Right	
TRIM LEVEL dB	0		0		0		0	
	Total System Gain 26dB		Total System Gain 26dB		Total System Gain 26dB		Total System Gain 26dB	

MODE OF USE

SPEAKERS
BRIDGE-TIED LOAD
2:1 SYSTEM

OUTPUT SETUP

	1		2		3		4	
	L		R		L		R	
OUTPUT NAME	1 Left		1 Right		2 Left		2 Right	
SPEAKER	Select preset		Select preset		Select preset		Select preset	
STEREO / MONO	STEREO		MONO		STEREO		MONO	
AMPLIFIER MODE	STEREO				STEREO			

OUTPUT SOURCE PRIORITY

SOURCE 1	Analog 1 Left	Analog 1 Right	Analog 2 Left	Analog 2 Right
SOURCE 2	Analog 2 Left	Analog 2 Right	Analog 1 Left	Analog 1 Right
PRIORITY	Source 1	Source 1	Source 1	Source 1

ZONE

	1		2		3		4	
ZONE	1		2		1		2	

OUTPUT VOLUME

OUTPUT VOLUME (%)	30		30		30		30	
TURN ON VOLUME (%)	30		30		30		30	
MAX VOLUME (%)	100		100		100		100	
MUTE	ON OFF		ON OFF		ON OFF		ON OFF	

FAQs / Customer Service

7.2.1 Input Source Setup

Input Level Meter

This displays the input signal sent to the amplifier.

Input Source

Select input source from the following selection
Analogue / Digital / AVB*

**AVB is available when two or more Bowers & Wilkins CDA amplifiers (CDA-2HD or CDA-4D) are connected to the same wired network using AVB enabled network hardware (AVB enabled switch). Analogue or digital input sources from other CDA amplifiers can be selected as an input source.*

AVB Input Sources

AVB input sources will be available when sibling devices are able to recognise each other on the network. The sibling device will be shown in the INPUT SOURCE drop down with the serial number or friendly name of the device shown in the list. You will be able to select either of the inputs from that device to use.

Input Name

All available input channels are listed in this section. Each input name can be customised to describe the type of input connected. Changes made to the Input Name will be reflected through the settings page.

Trim Level

Trim level can be adjusted for each channel from -11dB to +13dB with a 1dB of increments. The trim level allows levelling of the inputs before being amplified. The total system gain will be calculated and shown when trim level is adjusted.

INPUT SOURCE SETUP

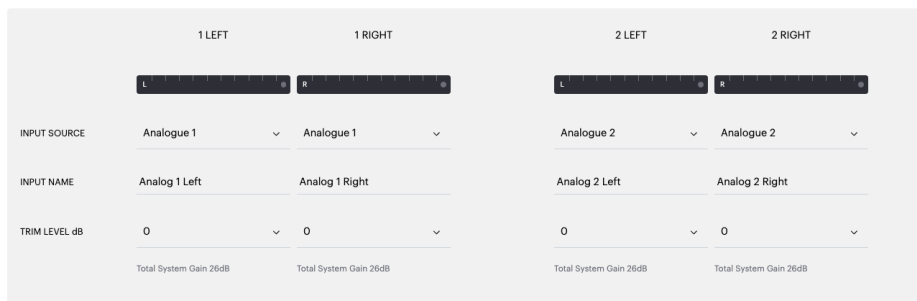

INPUT SOURCE SETUP

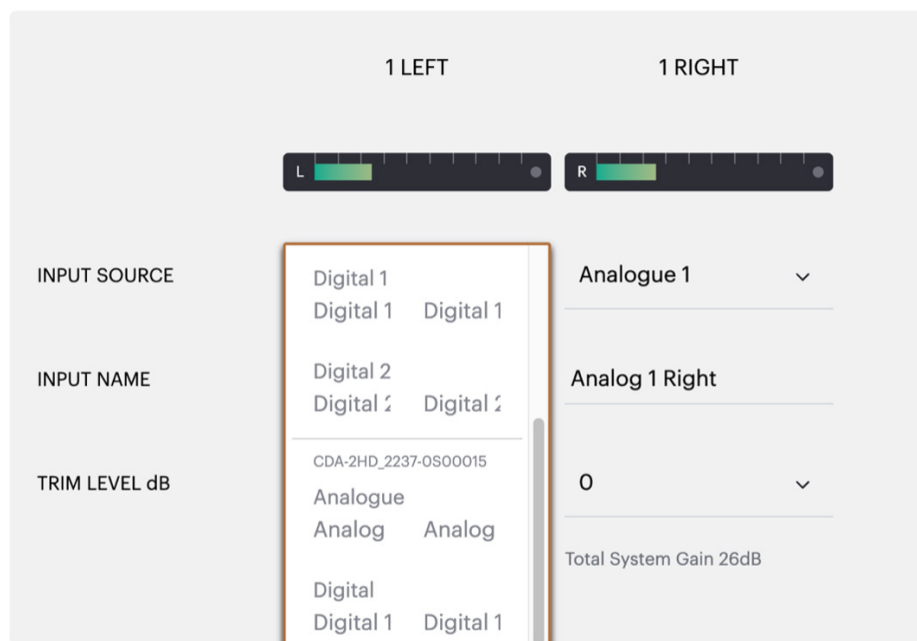

7.2.2 Mode of Use

The Mode of Use defines the system setup and the number of possible speaker configuration variants. There are 3 options: **Speaker Mode**, **Bridged-Tied Load Mode** and **2.1 System Mode**.



Choosing a different mode will determine the type of Bowers & Wilkins products available for selection in the next section.

Examples of the mode and configuration.

MODE OF USE



Speaker Mode

Four channels driving four speakers in stereo or mono.

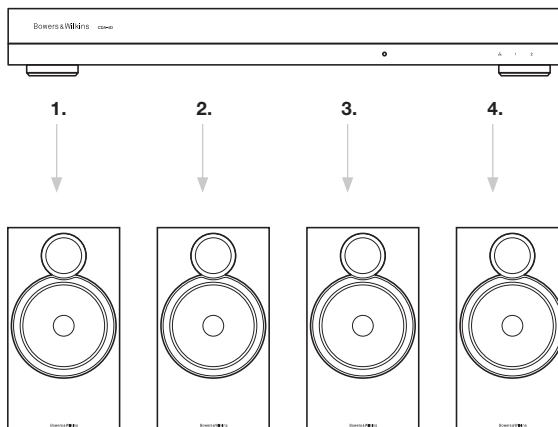

Bridge-Tied Load Mode

When more power is required, two channels can be bridged into one.

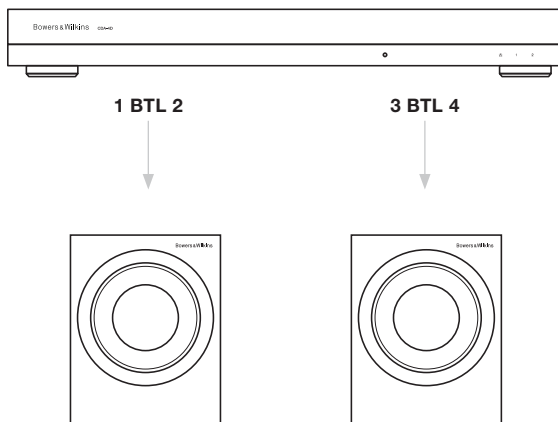

2.1 System Mode

2.1 system will allow users to drive two speakers in stereo or mono and bridge the other two channels into one for more power.

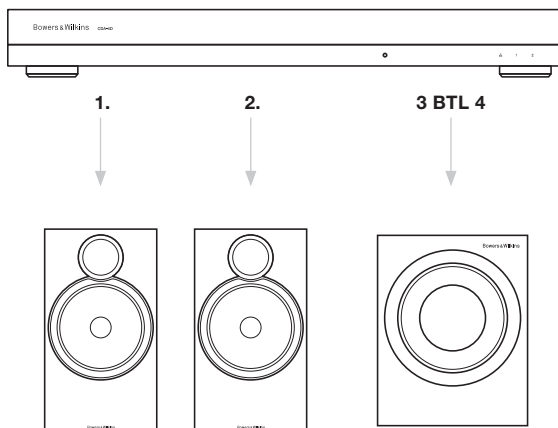

7.2.3 Output Setup

Output Level Meter

This monitors the audio output level sent to the speakers.

Output Name

This section list all available output channels. Each output name can be customised to describe the type of output connected. Changes made to the Output Name will be reflected through the settings page.

Speaker

Select the product model for each channel that are used with the CDA-4D. When using a non-Bowers & Wilkins product, please choose any User Preset.

Stereo / Mono

Allows each channel to be set for Stereo or Mono operation. When Mono is selected the Left and Right of the input selected will be combined to create Mono.

Amplifier Mode

When more power is required, two channels can be bridged into one channel. See 4.2 Connecting to speakers on how to connect a Bridge-Tied Load product.

7.2.4 Zone

Zone

CDA-4D has 2 output zone, Zone 1 or Zone 2. This groups the settings Output Volume, Turn On Volume and Mute across channels which have the same Zone.



Control System Drivers for Zones

If using this device on a single zone driver with a control system, please make sure zone 1 is selected on all outputs or the control system will not recognise the device.

7.2.5 Output Source Priority

Source 1

This is the primary source you will direct to the speakers. Left inputs default to left outputs and right inputs to right outputs.

Source 2

This is used as a secondary input source

Priority

CDA-4D has two available Input Source. This allows the user to define which input source to be used.

Source 1 only - Only play from Input Source 1.

Source 2 priority - Input Source 2 will have priority over Input Source 1, while Source 1 will mute.

Mix - Input Source 1 and Input Source 2 will be blended together when a signal is present on Input Source 2.

7.2.6 Output Volume

This is the main volume level control for each channel. When channels are placed in the same output group the levels will change simultaneously.

Output Volume

Main volume level control for each channel. When channels are placed in the same Output Zone the levels will change simultaneously.

Turn On Volume

In case of power outage, the TURN ON VOLUME ensures system always comes back on at the same level. When channels are placed in the same Output Zone the levels will change simultaneously.

Maximum Volume

Where high volume level is not required. Turn On Volume and Output Volume will be capped at Max Volume. This is an independent setting not affected by the Output Zone.

Mute

Eliminates the output from the speakers. Channels placed in the same Output Zone will change simultaneously.

OUTPUT SETUP

OUTPUT	1	2	3	4
	L	R	L	R
OUTPUT NAME	1 Left	1 Right	2 Left	2 Right
SPEAKER	Select preset	Select preset	Select preset	Select preset
STEREO / MONO	STEREO		STEREO	
AMPLIFIER MODE	STEREO		STEREO	

OUTPUT SOURCE PRIORITY

SOURCE 1	Analog 1 Left	Analog 1 Right	Analog 2 Left	Analog 2 Right
SOURCE 2	Analog 2 Left	Analog 2 Right	Analog 1 Left	Analog 1 Right
PRIORITY	Source 1	Source 1	Source 1	Source 1

ZONE

OUTPUT	1	2	3	4
ZONE	1		2	

OUTPUT VOLUME

OUTPUT VOLUME	30	30	30	30
TURN ON VOLUME	30	30	30	30
MAX VOLUME	100	100	100	100
MUTE	ON	OFF	ON	OFF

7.3 DSP Configuration

In the DSP Configuration tab, you can make fine adjustment like Phase, Delay and Tone Control on Bowers & Wilkins products. CDA-4D is designed to provide the best audio quality when used with Bowers & Wilkins speakers.

When a third-party product is being used, select an User Preset in the Speaker selection. Fine adjustments can be made to the sound using an 8-band parametric EQ graph, these can then be saved as preset, which can be exported and imported.

Bowers & Wilkins products

Bowers & Wilkins

BASIC SETTINGS
INPUT/OUTPUT SETTINGS
DSP CONFIGURATION

MODE OF USE

BRIDGE-TIED LOAD

OUTPUT INFORMATION

1	⋮	2	⋮	3	⋮	4	
L+R		L+R		L+R		L+R	
OUTPUT NAME		1 Left + 1 Right		2 Left + 2 Right		2 Left + 2 Right	
SPEAKER							

TEST SIGNAL

OUTPUT NAME	1 Left + 1 Right	2 Left + 2 Right
TEST SIGNAL	PINK NOISE	PINK NOISE
VOLUME	30	30
ON / OFF	ON OFF	ON OFF

PRESET MANAGEMENT

ALL PRESETS
Import / Export all presets to / from a location on your computer.

IMPORT EXPORT

SINGLE PRESETS
Import / Export individual preset to / from a location on your computer.

Select preset

IMPORT EXPORT

COPY PRESETS
Copy from / to preset from one location to another location.

Select the preset to be copied

Select preset

Select the preset to copy to

Select preset

CONFIRM

EDIT PRESETS
Rename current preset name to a custom name.

Select the preset to edit

Select preset

Rename preset

UPDATE

DSP SETTINGS

1 Left + 1 Right	2 Left + 2 Right
SPEAKER	
LISTENING MODE	
MUSIC MOVIE	
PHASE	
0 180	
DELAY	
mS	0 FEET 0 METERS 0
TONE CONTROL	
BASS	-6dB 0 6dB

FAQs / Customer Service

16

BASIC SETTINGS
INPUT/OUTPUT SETTINGS
DSP CONFIGURATION

MODE OF USE

SPEAKERS

OUTPUT INFORMATION

	1	⋮	2	3	⋮	4
	L		R	L		R
OUTPUT NAME	1 Left		1 Right	2 Left		2 Right
SPEAKER	User Preset 2		User Preset 2	User Preset 2		User Preset 2

TEST SIGNAL

OUTPUT NAME	1 Left		1 Right	2 Left		2 Right
TEST SIGNAL	PINK NOISE		PINK NOISE	PINK NOISE		PINK NOISE
VOLUME	- 30 +		- 30 +	- 30 +		- 30 +
ON / OFF	ON OFF		ON OFF	ON OFF		ON OFF

PRESET MANAGEMENT

ALL PRESETS
Import / Export all presets to / from a location on your computer.

IMPORT EXPORT

SINGLE PRESETS
Import / Export individual preset to / from a location on your computer.

Select preset

IMPORT EXPORT

COPY PRESETS
Copy from / to preset from one location to another location.

Select the preset to be copied

Select preset

Select the preset to copy to

Select preset

CONFIRM

EDIT PRESETS
Rename current preset name to a custom name.

Select the preset to edit

Select preset

Rename preset

UPDATE

DSP SETTINGS

	1 Left	1 Right	2 Left	2 Right
SPEAKER	User Preset 2			

EQ GRAPH

EQ PARAMETERS	EQ 1	EQ 2	EQ 3	EQ 4	EQ 5	EQ 6	EQ 7	EQ 8
ON / OFF	OFF	OFF	OFF	OFF	OFF	OFF	OFF	OFF
FREQUENCY HZ	20	100	500	1000	3000	5000	10000	18000
Q	0.707	0.707	0.707	0.707	0.707	0.707	0.707	0.707
GAIN +/- dB	0dB	0dB	0dB	0dB	0dB	0dB	0dB	0dB
FILTER TYPE	Parametric	Parametric	Parametric	Parametric	Parametric	Parametric	Parametric	Parametric

CROSSOVER

OFF LOW-PASS HIGH-PASS

FREQUENCY 100

FILTER SLOPE 12 dB/Octave

SAVE RESET

PHASE

0 180

DELAY

mS 0 FEET 0 METERS 0

FAQs / Customer Service

17

7.3.1 Output Information

This section displays the output selection made in the previous Output Setup page.

7.3.2 Test Signal

The CDA-4D includes a built-in pink noise generator. The pink noise signal can be used in conjunction with a spectrum analyser to measure the speakers.

Volume

The Volume setting here allows you change the volume of the pink noise. Changes applied here to the volume settings are independent to the Output Volume settings and will not affect those setting.

On/Off

The On/Off lets you play the test signal to the channel chosen.

7.3.3 Import, Export & Copy Presets

(available when a User Preset is selected)

This section allows import, export or copy of presets to or from a computer location.

All Presets

IMPORT (all presets) allows importing of all saved presets from a computer. This is useful when setting up multiple amplifiers.

EXPORT (all presets) allows saving all presets from the amplifier to a computer.

Single Preset

Note: Make sure you have selected a user preset from the dropdown before choosing an action (import/export)

IMPORT (single preset) allows importing of the selected presets from a computer.

EXPORT (single preset) allows saving the selected preset from the amplifier to a computer.

Copy Presets

This allows duplicating of the selected preset.

Rename Presets

This allows changing the name of the selected preset.

7.3.4.a DSP Settings for Bowers & Wilkins products

Select each channel tab to modify channel settings.

Output Tab

Select output tab to make adjustment to speaker settings for each output channel.

Speaker

This shows the product model selected for the output channel.

Listening Mode

(available when a Bowers & Wilkins subwoofer is selected)

Listening Mode provides equalisation options for music or movie programme material.

Phase

(available when a Bowers & Wilkins subwoofer or a User Preset is selected)
Phase default is set at OFF, when turn ON, Phase will invert at 180°.

Delay

DELAY is shown in milliseconds, feet or meters.
When a number is entered in any of the three fields, the other fields will be calculated automatically.
The minimum delay is 0.01 milliseconds, and the maximum delay is 20 milliseconds.

Tone Control

TONE CONTROL allows fine adjustment to the BASS and TREBLE.

OUTPUT INFORMATION

1 ... 2 3 ... 4

L+R L+R

OUTPUT NAME 1 Left + 1 Right 2 Left + 2 Right

SPEAKER

TEST SIGNAL

OUTPUT NAME 1 Left + 1 Right 2 Left + 2 Right

TEST SIGNAL PINK NOISE PINK NOISE

VOLUME % - 30 + - 30 +

ON / OFF ON OFF ON OFF

PRESET MANAGEMENT

ALL PRESETS
Import / Export all presets to / from a location on your computer.

IMPORT EXPORT

SINGLE PRESETS
Import / Export individual preset to / from a location on your computer.

Select preset

IMPORT EXPORT

COPY PRESETS
Copy from / to preset from one location to another location.

Select the preset to be copied

Select preset

Select the preset to copy to

Select preset

CONFIRM

EDIT PRESETS
Rename current preset name to a custom name.

Select the preset to edit

Select preset

Rename preset

UPDATE

DSP SETTINGS

1 Left + 1 Right 2 Left + 2 Right

SPEAKER

LISTENING MODE MUSIC MOVIE

PHASE 0 180

DELAY mS 0 FEET 0 METERS 0

TONE CONTROL BASS -6dB 0 6dB

7.3.4.b DSP Settings for third party products

Output Tab

Select output tab to make adjustment to speaker settings for each output.

EQ Graph

The EQ graph reflects the changes to the EQ Parameter.

EQ Parameter

The CDA-4D features an 8 band parametric EQ. Adjustments made to the EQ will be displayed on the output frequency response graph with the following configurable settings:

EQ On/Off

Use On/Off button to switch the frequency band to activate the frequency bandwidth applied.

Frequency Hz

Enter the center frequency (20Hz - 20kHz) or the filter to be adjusted.

EQ - Q

The Q factor controls the bandwidth that will be boosted by the equaliser. The lower the Q factor, the wider the bandwidth. The higher the Q factor, the narrower the bandwidth.

EQ Gain

EQ Gain increase or decrease the gain at selected frequency.

Filter Type

Filter Type available: Parametric, High Shelf or Low Shelf.

Crossover

This is where High Pass (HP) or Low Pass (LP) crossover filters can be applied.

Crossover

Crossover available: Off, High Shelf or Low Shelf.

Frequency

This is a user input field for the centre point in the crossover frequency bandwidth applied.

Filter Order (dB/Oct)

Filter Order selectable between -6dB, -12dB, -18dB, -24dB or Off.

Save / Reset

To apply the EQ and Crossover configuration made on the channel, click Save before moving to the next tab.

To restore to default setting or clear setting made to this section, click the Reset button.

Phase

Phase default is set to OFF, when turned ON, Phase will invert at 180°.

Delay

Delay is shown in milliseconds, feet or meters. When a number is entered in any of the three fields, the other fields will be calculated automatically. The minimum delay is 0.01 milliseconds, and the maximum delay is 20 milliseconds.

DSP SETTINGS

1 Left
1 Right
2 Left
2 Right

SPEAKER User Preset 2

EQ GRAPH

The EQ graph displays a flat line at 0dB across the entire frequency range from 20Hz to 20,000Hz. The y-axis ranges from -18dB to 18dB in 6dB increments. The x-axis is logarithmic, with major ticks at 20, 100, 500, 1000, 3000, 5000, 10000, and 20000 Hz.

EQ PARAMETERS

	EQ 1	EQ 2	EQ 3	EQ 4	EQ 5	EQ 6	EQ 7	EQ 8
ON / OFF	OFF	OFF	OFF	OFF	OFF	OFF	OFF	OFF
FREQUENCY HZ	20	100	500	1000	3000	5000	10000	18000
Q	0.707	0.707	0.707	0.707	0.707	0.707	0.707	0.707
GAIN +/- dB	0dB	0dB	0dB	0dB	0dB	0dB	0dB	0dB
FILTER TYPE	Parametric	Parametric	Parametric	Parametric	Parametric	Parametric	Parametric	Parametric

CROSSOVER

OFF | LOW-PASS | HIGH-PASS

FREQUENCY 100

FILTER SLOPE 12 dB/Octave

SAVE | RESET

PHASE

0 | 180

DELAY

mS 0 FEET 0 METERS 0

8. LED status

Power LED

LED	Status
Dark / unlit	Off
Dim white	Standby
White	On
Red	Fault

Zone status LED

LED	Status
Dark / unlit	Off / Signal not present / PSU fault
White	On and signal present
Red	Zone fault

Network status LED

LED	Status
White	Network present
Red	Network error

9. Support

Please visit the Bowers & Wilkins support site at www.bowerswilkins.com/support for further help or advice regarding your amplifier.

Environmental Information

This product complies with international directives, including but not limited to the Restriction of Hazardous Substances (RoHS) in electrical and electronic equipment, the Registration, Evaluation, Authorisation and restriction of Chemicals (REACH) and the disposal of Waste Electrical and Electronic Equipment (WEEE). Consult your local waste disposal authority for guidance on how properly to recycle or dispose of this product.

Diagram 13. LED status



10. Specifications

Audio Specifications

Load impedance range:	>3Ω per channel (>6Ω in bridge mode)
Output Power per channel, non-clipped:	60W into 8Ω 125W into 4Ω
Output Power bridge mode, non-clipped:	250W into 8Ω
Output Power total, all channels:	500W short term >125W continuous
DC offset voltage:	<50mV
Frequency Response (-3dB):	<10Hz to >30kHz, any load impedance
Frequency response accuracy 20Hz-20kHz:	+/-1dB
Dynamic range:	>85dB A-Weighted
THD+N (1kHz, 500W, 4Ω):	less than 1%
Voltage Gain:	15dB to 39dB, adjustable
Input impedance:	10KΩ
Maximum input voltage:	4 Vrms
Signal sense threshold:	2.5mV (independent of Gain setting)
Wake-up time:	<0.2s (If other zones active) <2s (From all zones inactive)
Turn-off time:	15 minutes from last signal detected
12V trigger input threshold:	typically 3V (recommended input is 5-15V)

Controls & Indicators

Front panel:	1 x Power LED (Unit active – White, Fault – Red) 1 x Network status LEDs (Network present – White, Fault – Red) 2 x Zone status LEDs (Signal present – White, Fault – Red)
Rear panel:	Reset button

Connectors

Input:	2 x RCA (pair) Phono socket, Analogue line in 2 x RCA Phono socket, Digital line in 1 x Ethernet
Output:	2 x 5.08mm Pitch 4-way Phoenix Combicon style
12V trigger control:	1 x 3.5 mm jack - 12V trigger IN 1 x 3.5 mm jack - 12V trigger OUT (Maximum 100mA pass-through)

Power

Power consumption:	<0.5W Standby, WoL disabled <0.5W Standby, WoL enabled 130W maximum average 1,600W peak
AC supply:	100-240V 50/60Hz
AC inlet:	IEC C14, switched

Thermal

Thermal dissipation:	1.7 BTU/hr (standby), 130 BTU/hr (Idle), 500 BTU/hr (max)
----------------------	---

Dimensions

Height:	42.5 mm (1.7 in) 1U [55.5mm (2.2in) plus feet]
Width:	437 mm (17.2 in)
Depth:	310 mm (12.2 in)
Net weight:	4.1kg (9.0lb)
Finish:	Black