

# **catalogue /2021**

**fuse flooring**

**flyt wide**

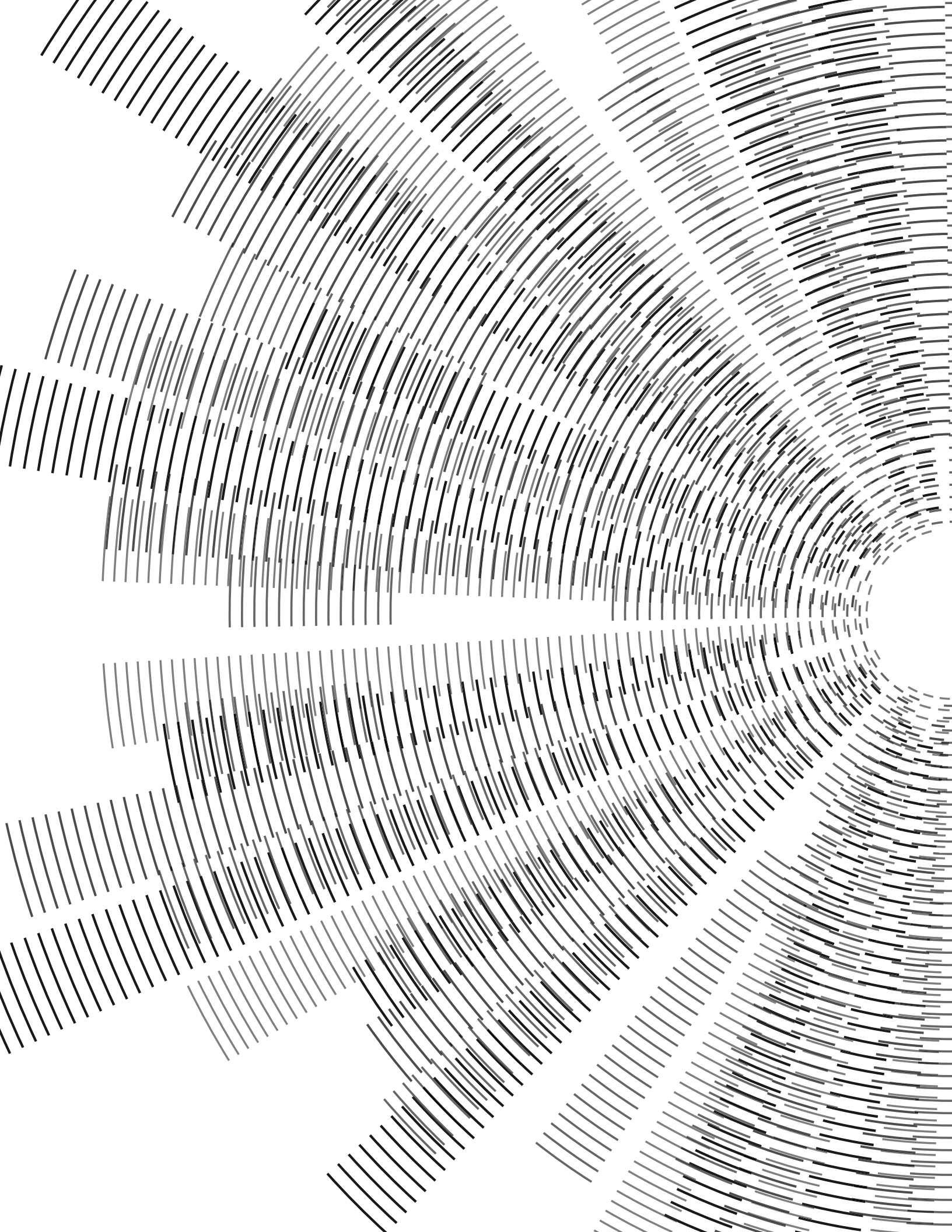

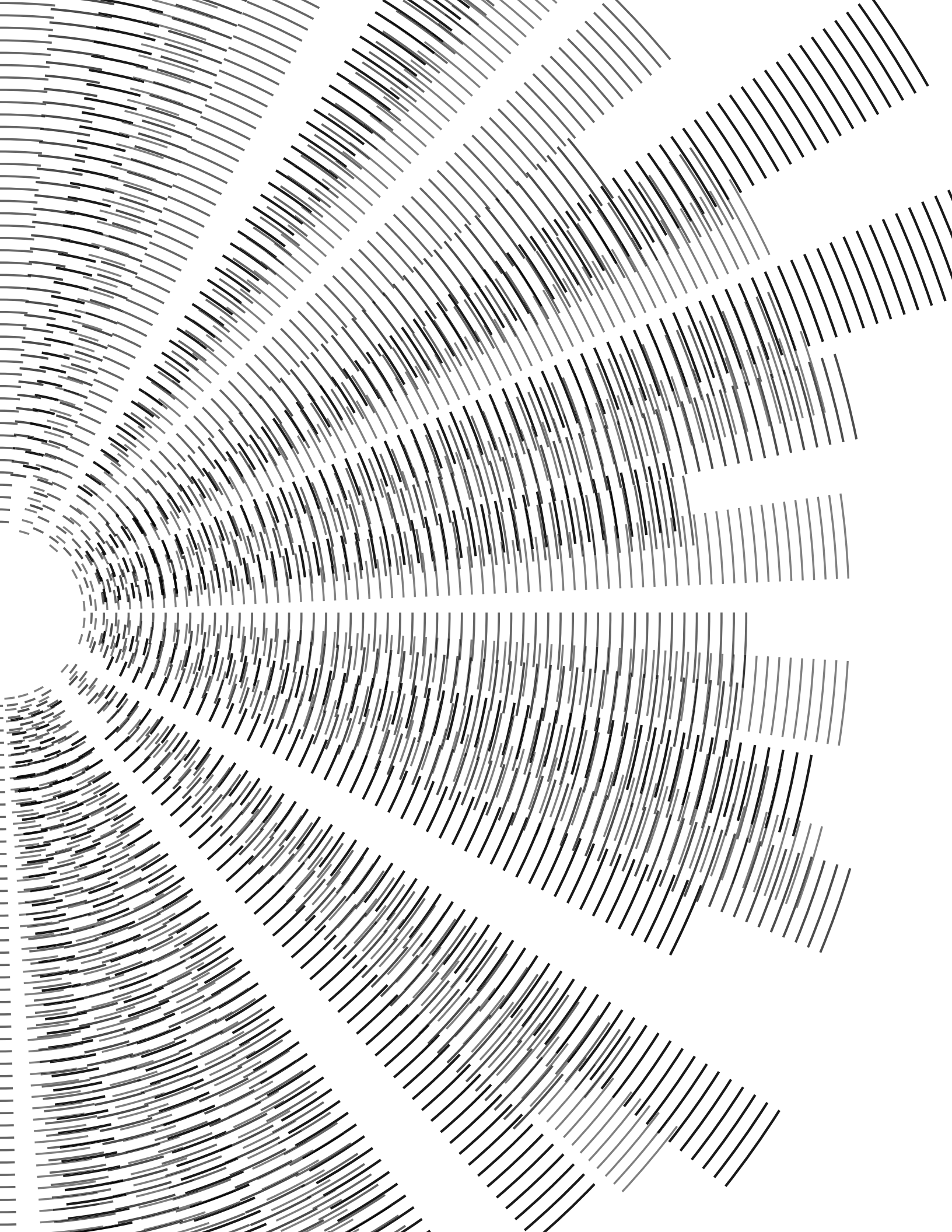

# about

---

**enhancing the intrinsic  
beauty of wood.**

Fuse Flooring is the result of an appreciation of nature - its ability to create and to inspire. We're moved by wood's uneven grain, its knots, and unpredictability. We want to enhance the intrinsic beauty of wood.

Our appreciation drives us to provide the best and most beautiful wood floors.

# sustainability

---

## Sustainable Materials

---

All wood in Fuse Flooring products comes from sustainably grown and harvested forests. The wood is fully certified on its journey from seed to board.

**certified real  
wood**

## Health Conscious

---

Materials and manufacturing are chosen to create a healthy product. Multiple certifications for low or no volatile organic compound (VOC) emissions ensure indoor air quality is not compromised.

## Responsible Manufacturing

---

Products are made in Germany and Austria where strong labour laws ensure workers are paid fairly and work in safe environments.

## Longevity

---

High quality products last longer and are replaced less frequently. Our floors' structural stability and refinishing options allow the floor to last for decades.

---

# certifications

---

## PEFC

---

The Programme for the Endorsement of Forest Certification (PEFC) is a global body that ensures sustainable forest management and prevents deforestation. It is similar and often considered equivalent to FSC.



## Floor Score

---

A third-party certification indicating low to zero VOC emissions. All parts of the product are tested including the wood, finish, and adhesive.



## Émissions Dans l'Air Intérieur A+

---

Measures total VOCs of 10 different substances for interior products. Class A+ is the lowest level of emissions that can be achieved.



## CARB2 Compliant

---

The CARB 2 standard is a limitation on formaldehyde emissions. Created by the California Air Resources Board (CARB), their mandates are strict and the standard across the industry.



## Real Wood

---

Certifies that the product is made exclusively from wood and not composite materials that may contain plastic or other synthetics.

# flyt wide collection

---

emin / mont blanc

matterhorn / mercury

baker / logan / dallas

brocken / tianzi



n /

---

c /

u / coto /

olomite /

flyt wide

by fuse flooring

# wide collection

---

Flyt Wide is distinguished by natural tones and large sized planks. Like the mountains they're named after, each colour has its own distinct style and charm, elevated by their scale. Using only full sized boards with subtle colour variation, these products have a calm, unified look.

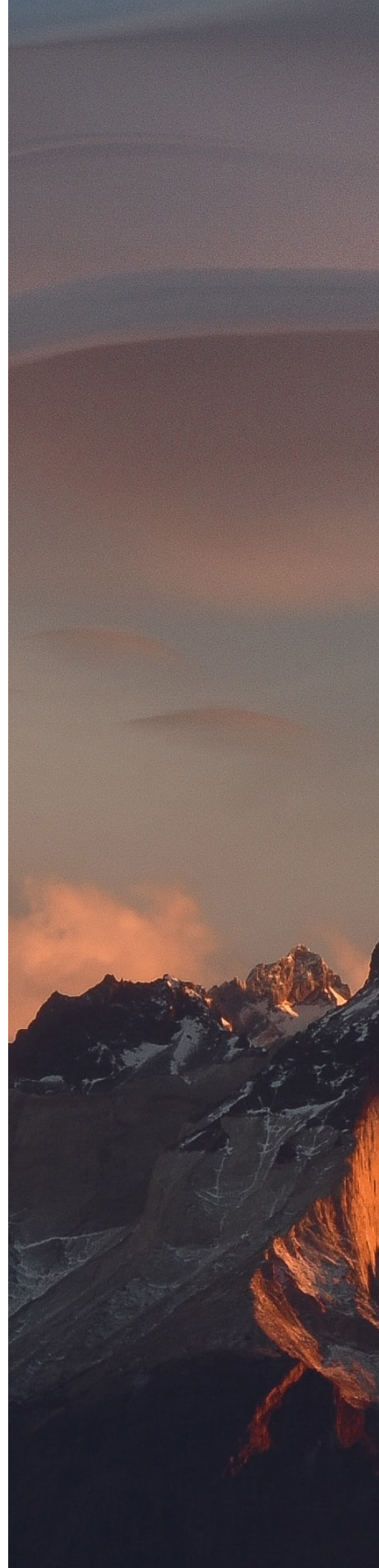







# features

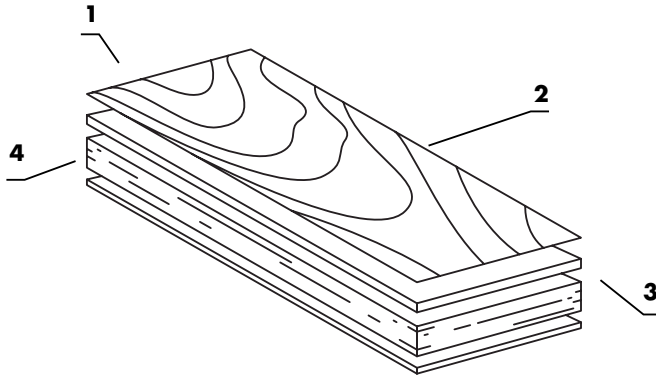

## dimensions

13 H x 160 W x 2010 L mm  
All planks are full length, no shorts.



## 1 / surface

Matte Bona Lacquer



## 2 / texture

Light Brush



## 3 / top layer

White Oak



## 4 / core

Quartersawn Spruce



## installation

Glue Down or Float  
Radiant Heat Compatible



# wide plank assembly

Connection System: Drop and Lock ("click")  
Bevel 4-sides

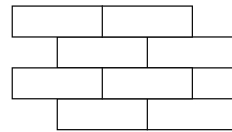

# accessory options

Made from the same material as the floor  
for a perfect match.

## stairs

---

Full cladding: riser, tread, and nosing  
Up to 2000 mm wide



## vents

---

All wood, with damper. Two sizes:  
76 W x 254 L mm  
101 W x 254 L mm



## nosing

---

Up to 2000 mm long  
108 mm wide



## flush reducer

---

Up to 2000 mm long  
44 mm wide

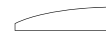

## t-mould

---

Up to 2000 mm long  
44 mm wide

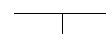



---

**emin**



---

**mont blanc**

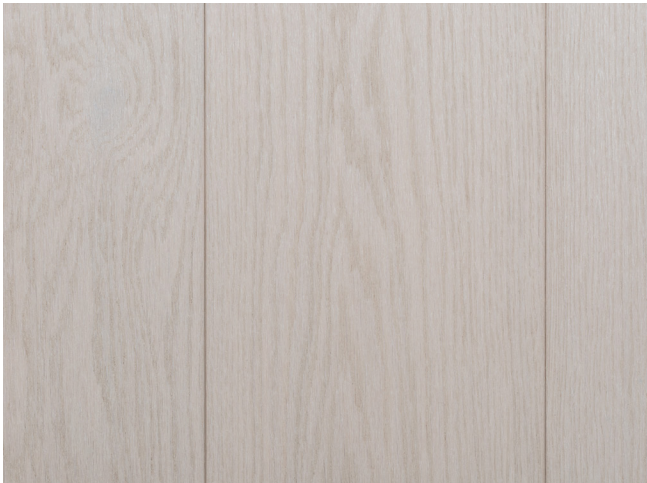

---

**matterhorn**

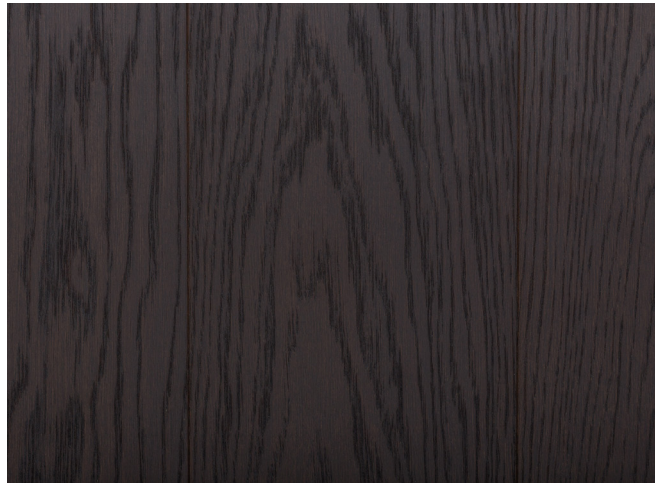

---

**meru**

---





---

**coto**



---

**baker**



---

**logan**



---

**dolomite**



---

**brocken**



---

**tianzi**

---



# wide specs

## 1 / product

### collection

Flyt

### style

Plank

### finish

Bona lacquer

### surface

Light brush

## 2 / construction

### type

Engineered hardwood

### layers

3-layer

### edge

Bevel 4-sides

### connections

Drop and lock ('click')

### dimensions

13 H x 160 W x 2010 L mm

## 3 / wood

### species

White Oak

### grade

Natural

### treatment

Stained

### cut

Flatsawn

### hardness

1360 (Janka scale)

## 4 / layers

### lamella

White Oak

### thickness

Nominal 2.5 mm

### core

Spruce

### thickness

9 mm

### backing

Spruce Ply

## origins

Made in Austria or Germany

## certifications

PEFC  
 Floor Score  
 Émissions Dans l'Air Intérieur A+  
 CARB2 Compliant  
 Real Wood







# grade guide



## select

Maximum size of sound knots	—	15 mm
Maximum size of open knots	—	Not allowed
Heart / Pith	—	Not allowed
Sapwood	—	Not allowed
End checks / End cracks	—	Not allowed
Small cracks	—	Not allowed
Colour Variation	—	Harmonic
Ingrown bark	—	15 mm



## nature

Maximum size of sound knots	—	30 mm
Maximum size of open knots	—	15 mm
Heart / Pith	—	Not allowed
Sapwood	—	Not allowed
End checks / End cracks	—	Not allowed
Small cracks	—	Allowed / up to 100 mm long & 1 mm
Colour Variation	—	Harmonic
Ingrown bark	—	Not allowed



Hardwood grades are based on the size and number of clear pieces that can be obtained from a board.

Grades are not determined by gut reactions but actual measurements of clear sections and definitions for characteristics.



### living / classic

Maximum size of sound knots	—	50 mm
Maximum size of open knots	—	25 mm
Heart / Pith	—	Not allowed
Sapwood	—	Allowed / 2 cm both sides or 4 cm one side
End checks / End cracks	—	Not allowed
Small cracks	—	Allowed / up to 100 mm long & 1 mm
Colour Variation	—	All colours
Ingrown bark	—	Not allowed



### rustic

Maximum size of sound knots	—	80 mm
Maximum size of open knots	—	50 mm
Heart / Pith	—	Allowed
Sapwood	—	Not allowed
End checks / End cracks	—	Allowed / up to 400 mm long & 8 mm
Small cracks	—	Allowed / up to 1105 mm & 1 mm
Colour Variation	—	All colours
Ingrown bark	—	Allowed / up to 50 mm long & 3mm

