

Kit Antenna / Kit Antena

Ref. 149884 (Ant-149831 + PSU-550104 + Y)

DATBOSSMIX LR

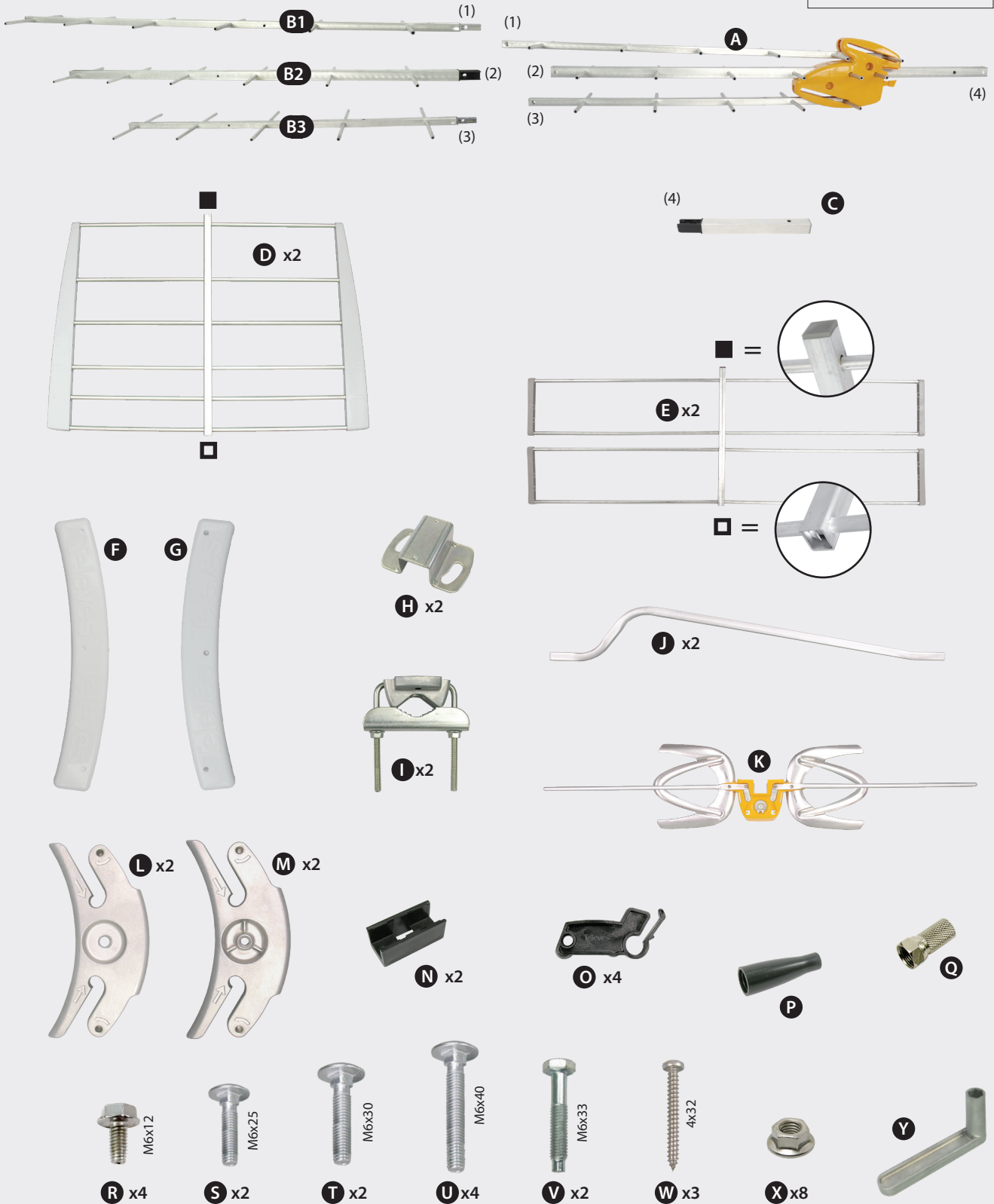

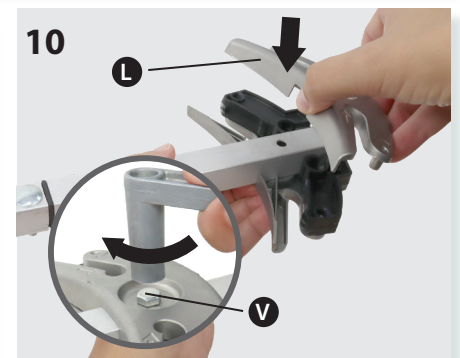
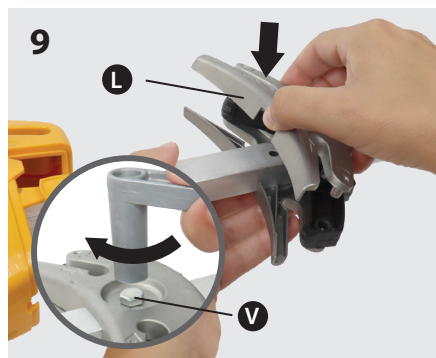
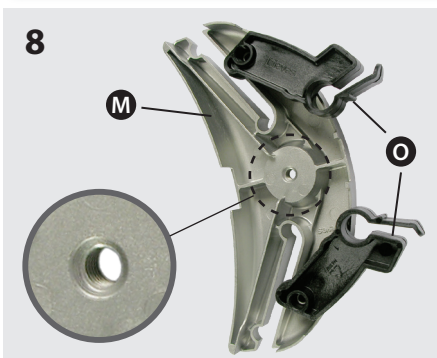
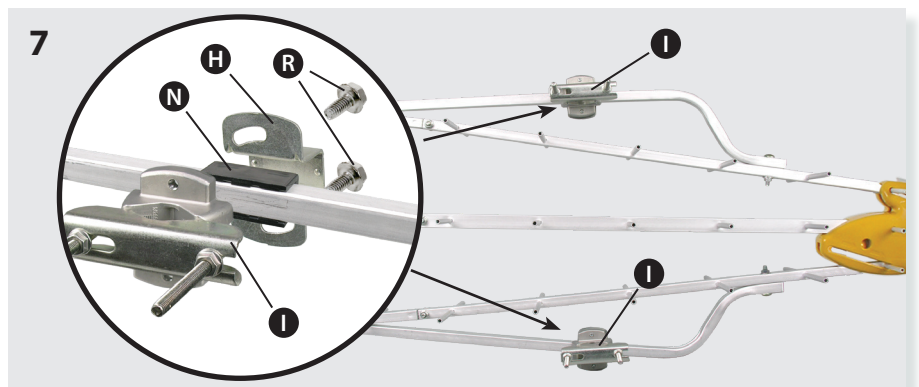
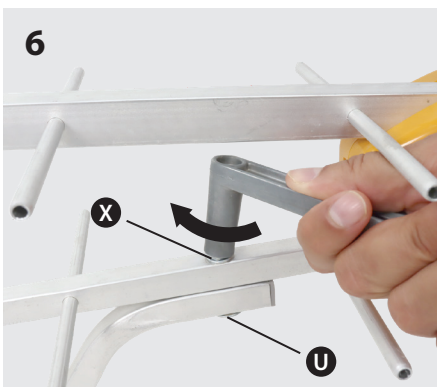
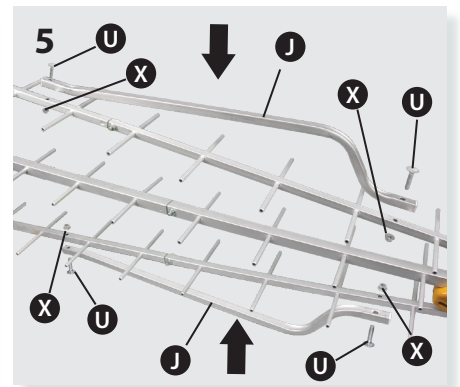
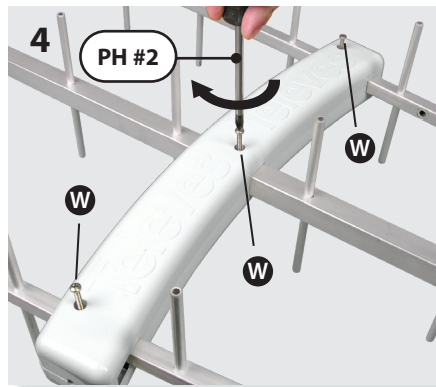
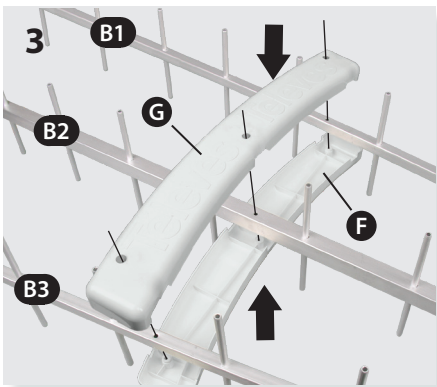
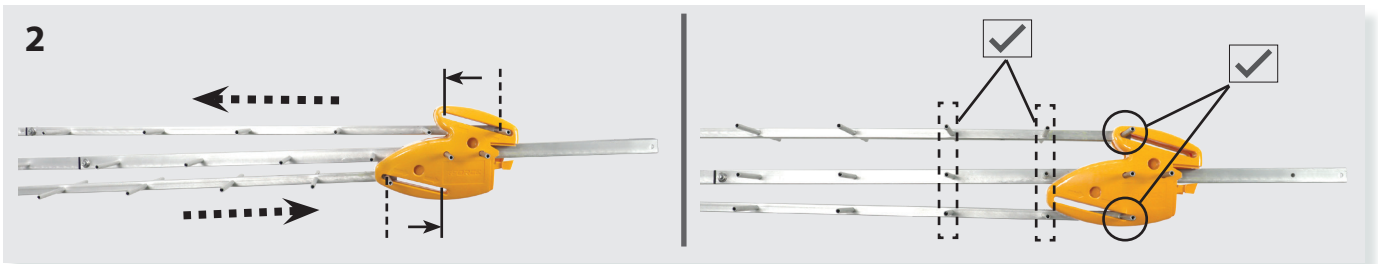
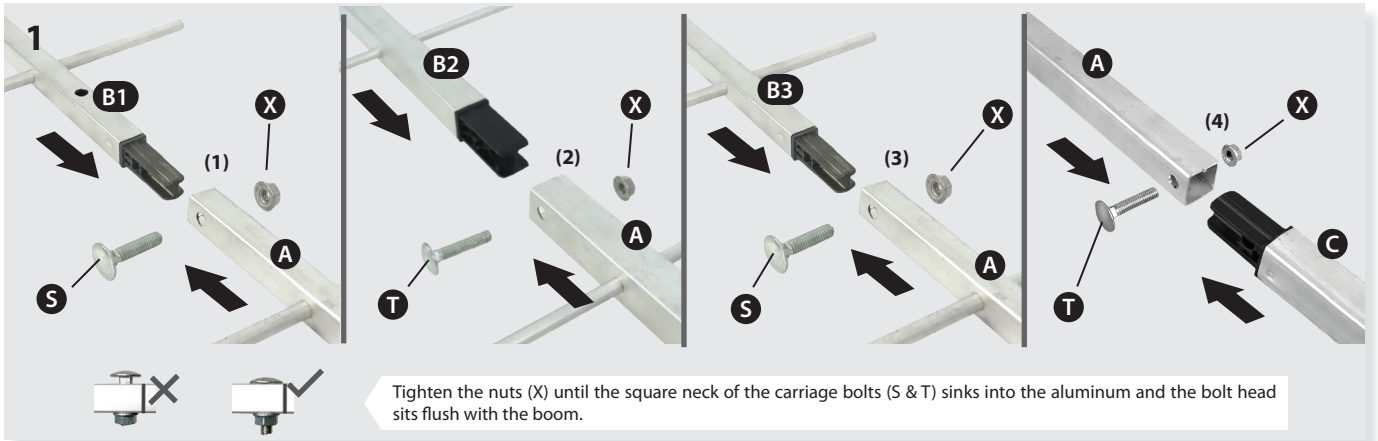

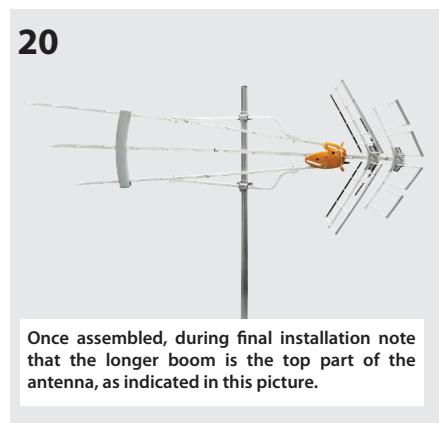
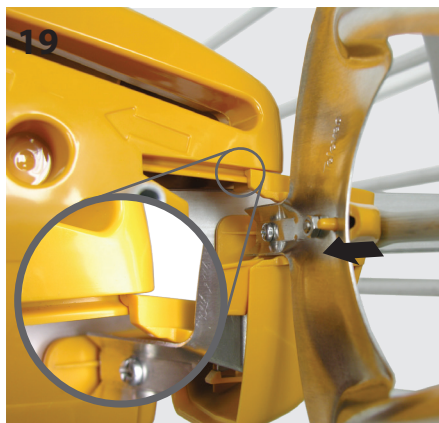
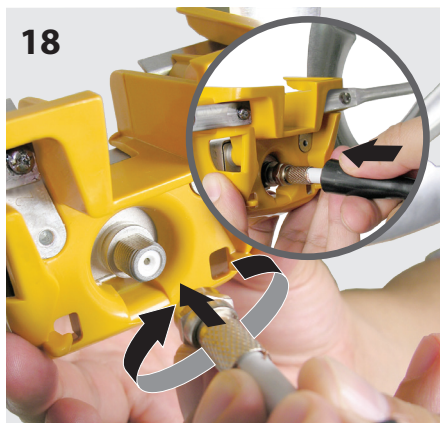
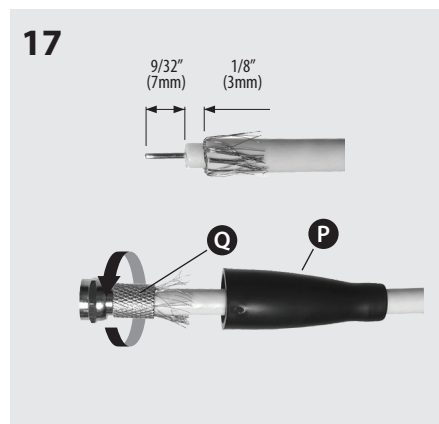
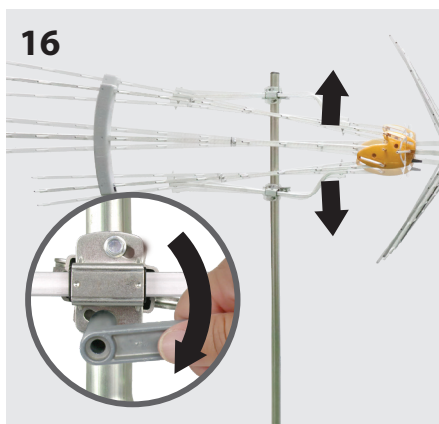
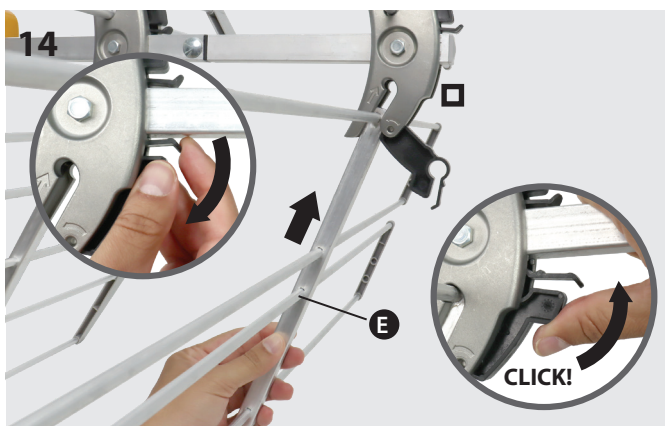
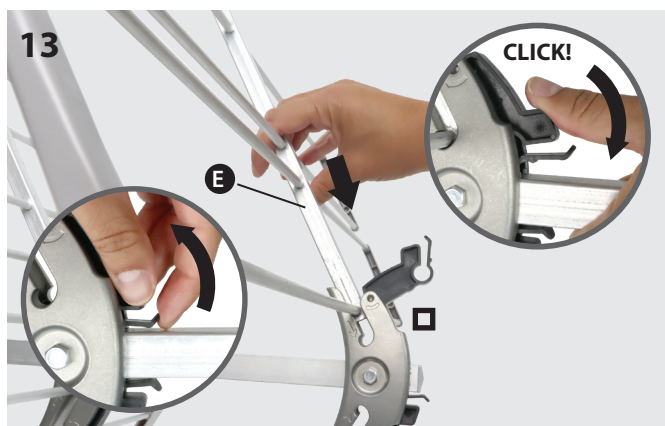
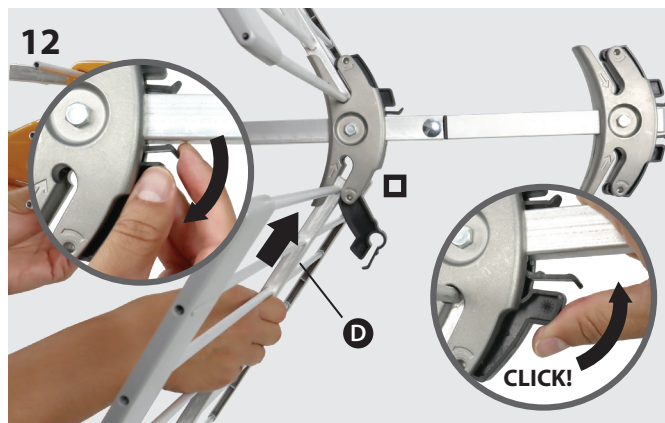
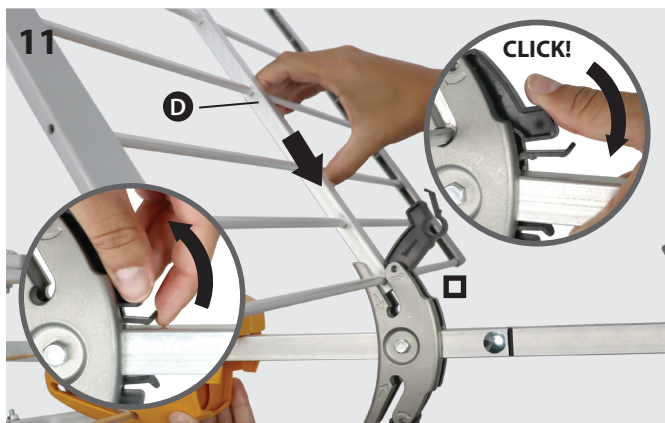

Technical specifications / Características técnicas

Mode	Modo	BOSS ON (Active)		
Operating band	Banda de trabajo	MHz	High VHF 174 - 216 CH7 - CH13	UHF 470 - 608 CH14 - CH36
Gain	Ganancia	dBi	36.5 max.*	46 max.*
Output level	Nivel de salida		Auto*	
Power supply	Alimentación	V ===	12	
Consumption	Consumo	mA	70 max	
Weight	Peso	lb / g	8.4 / 3820	
Dimensions	Dimensiones	in / mm	84.1 x 29 x 34 / 2137 x 735 x 864	
Wind load	Carga al viento	N	182.4 (@ 80 miles/h)(@ 130Km/h) 250.8 (@ 93 miles/h)(@ 150Km/h)	

*The gain is automatically adjusted according to the level of output / La ganancia varía automáticamente en función del nivel de salida.

Safety Instructions:

LIGHTNING PROTECTION

- ◆ If installed outdoors, be sure the antenna system is grounded so as to provide protection against voltage surges and built-up static charges. Section 810 of the National Electrical Code ANSI/NFPA70, or CSA C22.1 sections 10, 16, and 54, of the Canadian Electrical Code, provide information with respect to proper grounding of the mast and supporting structure, grounding of the antenna lead-in wire to an antenna discharge unit, size of grounding conductors, location of antenna-discharge unit, connection to grounding electrodes, and requirements for the grounding electrode (see figure and instructions).
- ◆ Mount the lightning arrester or 75 ohm coaxial grounding block as close as possible to where the 75 ohm coaxial cable down lead enters the house.
- ◆ The ground wires for both the mast and the down lead should be copper or aluminium wire, number eight (8) or larger.
- ◆ The down lead wire from the antenna to the lightning arrester and the mast ground wire should be secured to the house, spaced from four (4) to six (6) feet apart.
- ◆ In the case of a "ground up" antenna installation it may not be necessary to ground the mast if the mast extends four or more feet in the earth. Consult a TV serviceman for the proper depth in your location.

WARNINGS

- ◆ To prevent fire or shock hazard, do not expose the included power supply to rain or moisture.
- ◆ Installation of off-air antennas near power lines is dangerous. For your safety, follow the installation instructions.
- ◆ Any alteration or modification to the product or usage not in accordance with product instructions voids the warranty.

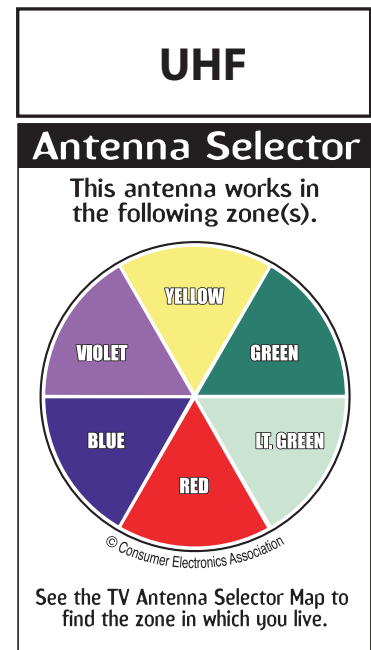
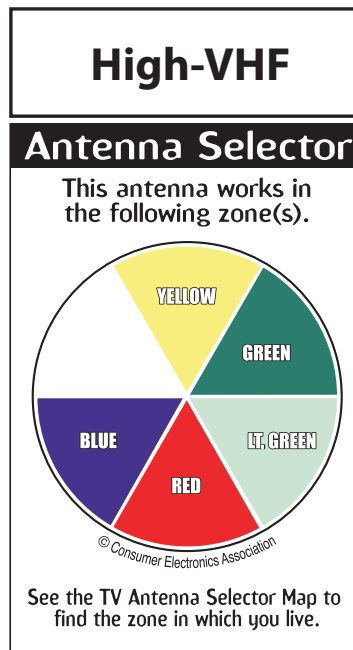

Example of antenna grounding as per National Electrical Code, ANSI/NFPA 70

