



**STATE OF THE ART
HANGING SYSTEMS**
PRODUCT CATALOGUE

▶ ABOUT ARTITEQ

Based in Tilburg (NL), Artiteq is a specialist in hanging concepts, and has been developing flexible hanging systems for pictures and other wall decorations since 1995. Since decorating walls involves more than just hanging pictures, Artiteq combines this philosophy with its product specialism and has developed an extensive range of products in recent years. In addition to the picture hanging systems, Artiteq also markets display systems and solo hanging systems (separate from a rail system). Thanks in part to in-house expertise, and combined with its own product development and quality control departments, Artiteq also offers successful customised solutions for a variety of hanging needs. Flexibility and a continuous drive to keep innovating are Artiteq's strengths. In designing and producing our hanging systems, we aim to offer the best quality, whilst always placing a high priority on the environment and sustainability. Artiteq hanging systems are sold worldwide in over 60 countries.

Meet our company



Artiteq has its own Research & Development department and generally develops all products with a Safety Factor of 3. In terms of products with higher safety risks (f.e. products which hang in open spaces not against walls) or when specific materials are used, this safety factor can even be 5 or higher. The Quality Control department checks safety in relation to the weight that can be hung from the products, but also checks the appearance and functionality of the products. In terms of the Micro Grip hook, Artiteq applies the quality assurance of TÜV, a certification that is extended to more Artiteq products. Based on the foregoing, Artiteq provides a 10-year* guarantee on all of its products (with the exception of Combi Rail Pro Light: a 2-year guarantee applies to electrical components).

PRODUCT WARRANTY

▶ SAFETY

Artiteq has its own Research & Development department and generally develops all products with a Safety Factor of 3. In terms of products with higher safety risks (f.e. products which hang in open spaces not against walls) or when specific materials are used, this safety factor can even be 5 or higher.

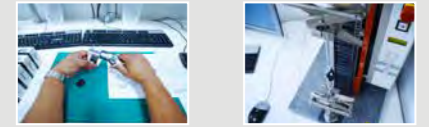

example of Micro Grip test results

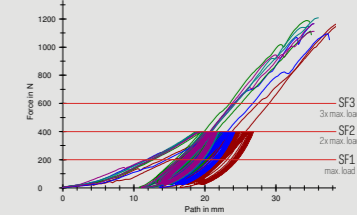

▶ QUALITY CONTROL

Artiteq has its own Quality Control department. Not only does this department check safety in relation to the weight that can be hung from the products, but also checks the appearance and functionality of the products.

▶ TÜV

In terms of the Micro Grip hook, Artiteq applies the quality assurance of TÜV, a certification that will be extended to include more Artiteq products in the near future.

▶ GUARANTEE

Based on the foregoing, Artiteq provides a 10-year* guarantee on all of its products. *with the exception of Combi Rail Pro Light (a 2-year guarantee applies to electrical components).

▶ CE

In terms of the Combi Rail Pro Light picture hanging system (a product with electrical components), Artiteq declares that this product fulfils the applicable guidelines in accordance with standards EN 60598-1 / EN 60598-2-1 / EN 60570 / EN 55015 and EN 61347. No CE standardisation exists for all other Artiteq products. The Artiteq integrated picture hanging systems do not form part of a building's construction. It is important to emphasise that the systems are not intended to carry the construction of ceilings. The profiles are designed solely for hanging products (i.e. wall decorations, such as paintings, photo frames, etc.). The profiles may not be used for (are not designed for) absorbing additional forces.



- ✓ MARKETING & SALES
- ✓ IN-HOUSE RESEARCH & DEVELOPMENT

- ✓ PRODUCT SPECIALIST
- ✓ IN-HOUSE QUALITY CONTROL



PRODUCT CATEGORIES

PICTURE HANGING SYSTEMS

WALL SYSTEMS	06
CEILING SYSTEMS	20
INTEGRATED SYSTEMS	26
SOLO SYSTEMS	40
ALL-IN-ONE KITS	48
HANGINGS WIRES AND HOOKS	56
FRAME ACCESSORIES	70

DISPLAY HANGING SYSTEMS

CABLE HANGING SYSTEMS	78
RAIL HANGING SYSTEMS	94
MISCELLANEOUS	106

SIGN HANGING SYSTEMS

110

SALES SUPPORT

128

▶ PICTURE HANGING SYSTEMS

WALL



FLEXIBLE
SAFE
STRONG

CLICK RAIL



RAIL

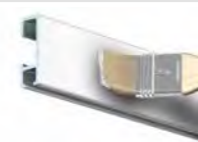

CLICK RAIL - WHITE RAL 9010

CLICK RAIL - WHITE/PRIMER RAL 9016

	P/1*	P/20*	P/1*	P/20*
ARTICLE NO. 150 cm				9.4360
ARTICLE NO. 200 cm	9.4303	9.4353	9.4348	9.4350
ARTICLE NO. 300 cm	9.4304	9.4354	9.4349	9.4351
ARTICLE NO. 600 cm	9.4372		9.4346	
	FASTENER KIT WHITE		FASTENER KIT WHITE	
ARTICLE NO. 200 cm	4065		4065	
ARTICLE NO. 300 cm	4061		4061	

RAIL



CLICK RAIL - ALU BRUSHED

CLICK RAIL - BLACK STRUCTURE

	P/1*	P/20*	P/1*	P/20*
ARTICLE NO. 150 cm				
ARTICLE NO. 200 cm	9.4341	9.4340		05.01210
ARTICLE NO. 300 cm	9.4343	9.4342		05.01310
ARTICLE NO. 600 cm	9.4339			
	FASTENER KIT GREY		FASTENER KIT BLACK	
ARTICLE NO. 200 cm	4064		5094	
ARTICLE NO. 300 cm	4060		5095	

CONTENT FASTENER KIT



installation video



		QUANTITY 200 cm	QUANTITY 300 cm
9.4113	CLICK&CONNECT	6x	9x
9.4929	SCREW	6x	9x
9.4931	PLUG	6x	9x
9.4105 (WHITE) / 9.4104 (GREY) / 9.4112 (BLACK)	END CAP	2x	2x
9.4107 (WHITE) / 9.4108 (GREY) / 9.4114 (BLACK)	CORNER CONNECTOR	1x	1x
2386	INSTRUCTION	1x	1x

ALL MOUNTING MATERIAL MAY BE ORDERED SEPERATELY. SEE OVERVIEW ON PAGE 38
* P/1: PACKAGED BY THE PIECE IN FOIL / P/20: PACKAGED PER 20 IN FOIL

30
KG/M

10
YEAR
WARRANTY

click

CLICK

CONNECT

3 CLIPS / M

FLEXIBLE
STRONG
RELIABLE



The Click Rail is a flexible picture hanging system that you mount to the wall. Using the Click&Connect system, mounting the rail system is fast and easy. The Click Rail may be installed flush against the ceiling and may also be repainted, for example in the same colour as the wall or ceiling. This helps the picture hanging system 'blend in' with the wall or ceiling, making it nearly invisible. The hanging rail's appearance makes it easy to integrate in any room or interior. You always have flexibility in hanging posters, pictures or photo frames thanks to the hanging wires with hooks that you can click into any desired location on the rail system.

CLICK RAIL PRO



50
KG/M

10
YEAR
WARRANTY

3 CLIPS / M

The Click Rail Pro hanging system is the professional, heavy-duty version of the Click Rail. The rail is quick and easy to instal thanks to the Click&Connect clips, and can be mounted on the wall, flush against the ceiling. It is possible to mount the rail in such a way that the sliders for the hanging wire may be subtly hidden behind the rail. The Click Rail Pro picture hanging system has a maximum load capacity of 50 kg/m. Hanging heavy pictures and wall decorations is no problem with the Click Rail Pro. Click Rail Pro is a strong picture hanging system that you can trust when it comes to hanging your art on the wall. The hanging wires may be moved and clicked into the rail again at any desired location. This assures you of flexibility in what you display on your walls. Moving or replacing a work of art is fast and easy, and there's no risk of damaging the walls.

RAIL



CLICK RAIL PRO - WHITE/PRIMER
RAL 9016



CLICK RAIL PRO - ALU BRUSHED

ARTICLE NO. 200 cm	05.05420	05.05320
ARTICLE NO. 300 cm	05.05430	05.05330
FASTENER KIT WHITE		FASTENER KIT GREY
ARTICLE NO. 200 cm	4067	4066
ARTICLE NO. 300 cm	4074	4073

CLICK RAIL PRO



installation
video

CONTENT FASTENER KIT



		QUANTITY 200 cm	QUANTITY 300 cm
9.4124	CLICK&CONNECT	6x	9x
9.4929	SCREW	6x	9x
9.4931	PLUG	6x	9x
9.4120 (WHITE) / 9.4121 (GREY)	END CAP	2x	2x
9.4122 (WHITE) / 9.4123 (GREY)	CORNER CONNECTOR	1x	1x
2387	INSTRUCTION	1x	1x

ALL MOUNTING MATERIAL MAY BE ORDERED SEPERATELY. SEE OVERVIEW ON PAGE 38

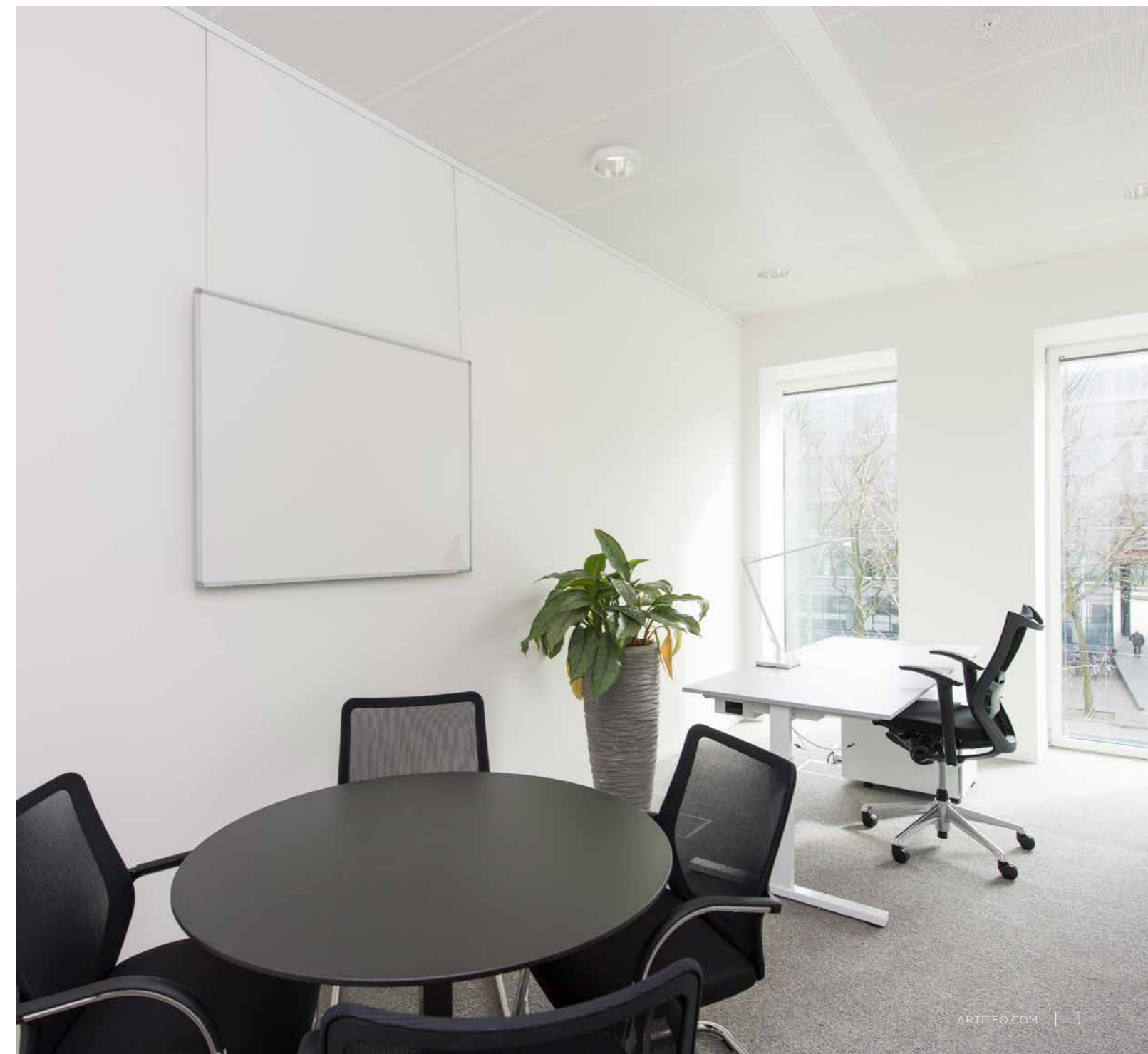

CONTOUR RAIL



Compact and attractive hanging system

"Less rail, more art". Contour Rail gets the job done in spite of its minimal dimensions, and has an attractive, sleek design. Hanging pictures, or hanging and moving framed photos is easy thanks to the Contour Rail. Using the clips, the picture rails may be mounted to the wall (minimum distance from the ceiling: 15 mm). In addition to the aluminium version of the rail, the available model in white may be painted in any colour. The refined style of the 1 mm Twister hanging wires with Micro Grip 1 mm suspension hook make them a perfect match for the compact shape of this hanging system.

20
KG/M

10
YEAR
WARRANTY

3 CLIPS / M

RAIL



CONTOUR RAIL
WHITE PRIMER
RAL 9016

CONTOUR RAIL
ALU

P/1*

P/1*

ARTICLE NO. 200 cm	30.11201	30.11200
ARTICLE NO. 300 cm	30.11301	30.11300
FASTENER KIT WHITE		FASTENER KIT GREY
ARTICLE NO. 200 cm	30.31310	30.31320
ARTICLE NO. 300 cm	30.31330	30.31340



installation
video

CONTENT FASTENER KIT

			QUANTITY 200 cm	QUANTITY 300 cm
	30.31110	CLICK&CONNECT	6x	9x
	9.4929	SCREW	6x	9x
	9.4931	PLUG	6x	9x
	30.31210 (WHITE) / 30.31220 (GREY)	END CAP	2x	2x
	2388	INSTRUCTION	1x	1x

ALL MOUNTING MATERIAL MAY BE ORDERED SEPARATELY. SEE OVERVIEW ON PAGE 38
* P/1: PACKAGED BY THE PIECE IN FOIL

CONTOUR RAIL GLUED



Contour Rail glued - hanging without drilling

Looking for a compact hanging rail that 'disappears' in a room? Contour Rail offers the solution: the rail can also be mounted to the ceiling using glue. Thanks to the special design, the glue may be applied in and on the profile in the desired manner. When the Contour Rail is glued and painted in the same colour as the wall, it becomes inconspicuous while still offering all the advantages of a flexible hanging system: the ability to hang and move pictures without damaging the walls.

10
KG/M

10
YEAR
WARRANTY

RAIL



CONTOUR RAIL
WHITE PRIMER
RAL 9016

CONTOUR RAIL
ALU

P/1*

P/1*

ARTICLE NO. 200 cm	30.11201	30.11200
ARTICLE NO. 300 cm	30.11301	30.11300

END CAP

COLOUR	WHITE	GREY
ARTICLE NO.	30.31210	30.31220

FASTENER MATERIAL



CONTOUR RAIL GLUE SET (FOR FIXATION OF 4,5-5M)

3M SURFACE CLEANERS & GLUE PARABOND 600 WHITE 290 ML

ARTICLE NO.	30.31180
-------------	----------

* P/1: PACKAGED BY THE PIECE IN FOIL

COMBI RAIL PRO LIGHT



50
KG/M

2
YEAR WARRANTY

CONNECT

3 CLIPS / M



RAIL / PARTS

COMBI RAIL PRO LIGHT RAL 9010 (INCLUDES FASTENERS AND END CAPS)	COMBI RAIL PRO LIGHT CONNECTOR SET (BOTH STRAIGHT AND CORNER CONNECTOR)	CONNECTION BLOCK	TRAFO HALOGEN LED 220/12 INCLUDES CONNECTION BLOCK	60 W	100 W	300 W
ARTICLE NO. 200 cm	40.11200	40.31300	40.31500	40.32060	40.32100	40.32300
ARTICLE NO. 300 cm	40.11300	40.31300	40.31500	40.32060	40.32100	40.32300

LAMPS

FITTING			MASTER LED PHILIPS LV 3000K WARM WHITE	
20 cm	50 cm	70 cm	6,5 W	8 W
ARTICLE NO.	40.21200	40.21500	40.21700	40.41306 40.41308



FLEXIBLE
SAFE
HIGH END



Flexible picture hanging and lighting system in one

Combi Rail Pro Light combines picture hanging and lighting in one system. The rail's attractive, neutral design enables it to be integrated in almost every style of interior. Use the adjustable fittings to provide optimum and high-quality lighting for pictures and other wall decorations on your wall. You can position the Twister suspension wires anywhere along the rail, making it easy to change and move artwork and pictures. This flexible and user-friendly picture hanging system guarantees that the walls in your room will stay undamaged.

Easy installation in three steps

In 3 quick steps you can fit the rail and connect the power supply without requiring special tools and techniques. Step 1 comprises fitting the clips (Click&Connect) to the wall and clicking the rail to the clips. The rail immediately fits firmly in place after which you can carry out Step 2; connecting the power supply. Step 3 involves installing the picture lighting fittings: with just one quarter turn you can position these where you want on the rail. The fittings are suitable for LED and halogen lamps and are available in lengths of 20 cm, 50 cm and 70 cm. You can adjust the high-temperature resistant luminaire cover, manufactured from high-quality plastic, to direct the lighting onto your picture. The conductive and hanging functions for the hanging rail with picture lighting are separated. All Combi Rail Pro Light components are approved by reputable, independent certification authorities.

CLASSIC RAIL



20
KG/M

10
YEAR
WARRANTY

4 SCREWS/ M

Change pictures quickly and easily with Classic Rail

The Classic Rail is a wall rail that is often used in galleries and at exhibitions. This hanging system has an open J-shape which, with the aid of rods and sliding springs, makes it easy to hang pictures and other wall decorations. If you are looking for a discreet alternative to a rod, it is possible to use a cylinder hook with a transparent perlon cord in the rail. Depending on the weight of the picture or wall decoration, various hooks may be slid onto the perlon hanging wire.

A hanging rail for a contemporary interior

The Classic Rail is a J-shaped, open rail system with a modern look. This picture hanging system is available in white or aluminium. The rods that may be placed in the rail vary in thickness from 2 to 3 mm, and have a maximum load capacity of 20 kg. Available in white or steel, the rods use various sliding springs.

RAIL

	CLASSIC RAIL - WHITE RAL 9010		CLASSIC RAIL - WHITE PRIMER RAL 9016		CLASSIC RAIL - ALU	
	P/1*	P/20*	P/1*	P/20*	P/1*	P/20*
ARTICLE NO. 200 cm	9.4307	9.4357	-	9.4390	9.4305	-
ARTICLE NO. 300 cm	9.4308	9.4358	-	9.4391	9.4306	-
	FASTENER KIT WHITE		FASTENER KIT WHITE		FASTENER KIT GREY	
ARTICLE NO. 200 cm	4072		4072		4071	
ARTICLE NO. 300 cm	4079		4079		4078	



installation video

CONTENT FASTENER KIT

			QUANTITY 200 cm	QUANTITY 300 cm
	9.4901 (WHITE) / 9.4902 (GREY)	SCREW	8x	12x
	9.4931	PLUG	8x	12x
	2389	INSTRUCTION	1x	1x

ALL MOUNTING MATERIAL MAY BE ORDERED SEPARATELY. SEE OVERVIEW ON PAGE 38
* P/1: PACKAGED BY THE PIECE IN FOIL / P/20 PACKAGED PER 20 IN FOIL

RODS

	ROD WHITE STEEL 2 mm MAX. 20 kg	ROD WHITE STEEL 3 mm MAX. 20 kg	ROD STEEL 3 mm MAX. 20 kg
ARTICLE NO. 100 cm	9.4216*	9.4161	9.4151
ARTICLE NO. 150 cm	-	9.4162	9.4152
ARTICLE NO. 200 cm	9.4217*	9.4163	9.4153
ARTICLE NO. 300 cm	-	9.4165	9.4155

*COMPATIBLE WITH HOOKS 9.4207, 9.4261, 3041200/50 - SEE PAGE 58

SLIDING SPRINGS

	SLIDING SPRING STAINLESS STEEL 3 mm MAX. 20 kg	SLIDING SPRING STAINLESS STEEL + LIP 3 mm MAX. 10 kg
	9.4170	9.4171

CYLINDER HOOKS

	CYLINDER HOOK WHITE MAX. 15 kg	CYLINDER HOOK ALU MAX. 15 kg
	9.4237	9.4244

* FOR USE WITH HANGING WIRE PERLON + SLIDER

WIRES

	PERLON + SLIDER 2 mm MAX. 15 kg
ARTICLE NO. 100 cm	9.4424
ARTICLE NO. 150 cm	9.4425
ARTICLE NO. 200 cm	9.4426
ARTICLE NO. 250 cm	9.4427
ARTICLE NO. 300 cm	9.4428



MICRO GRIP 2 mm
30.41200 | 20 kg



MICRO GRIP LOCK 2 mm
30.41250 | 20 kg

FOR MORE PICTURE HOOKS SEE PAGE 58

CLASSIC RAIL+

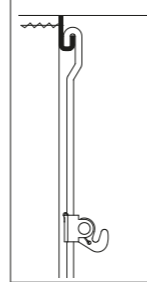
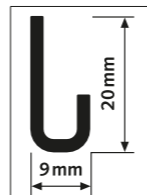

100
KG/M

10
YEAR
WARRANTY



4 SCREWS/ M

The Classic Rail+ is a picture hanging system for walls that has been specially developed for hanging heavier pictures and wall decorations (up to 100 kg). This hanging system is often used in galleries, at exhibitions and in museums. The hanging rail has an open, J-shaped design that makes it possible to hang a variety of rods equipped with rod hooks. This makes it extremely easy to hang or change art on the wall. The Classic Rail+ is available in white and aluminium. A variety of aluminium or steel rods may be used for decorations weighing up to a maximum of 100 kg.

Secure picture hanging system

The Classic Rail+ makes it possible to hang pictures and wall decorations in a secure manner in rooms where this is required. Thanks to a blocking device, the rod is blocked in the rail and the picture enjoys extra protection when special anti-theft hooks are used on the rod itself.

RAIL



CLASSIC RAIL+ - WHITE
RAL 9010

CLASSIC RAIL+ - ALU ANODISED

P/1*

P/1*

ARTICLE NO.	200 cm	300 cm
ARTICLE NO. 200 cm	9.4318	9.4320
ARTICLE NO. 300 cm	9.4319	9.4321
FASTENER KIT WHITE		FASTENER KIT GREY
ARTICLE NO. 200 cm	4072	4071
ARTICLE NO. 300 cm	4079	4078



installation video

CONTENT FASTENER KIT

			QUANTITY 200 cm	QUANTITY 300 cm
9.4901 (WHITE) / 9.4902 (GREY)	SCREW		8x	12x
9.4931	PLUG		8x	12x
2389	INSTRUCTION		1x	1x



ALL MOUNTING MATERIAL MAY BE ORDERED SEPERATELY. SEE OVERVIEW ON PAGE 38
* P/1: PACKAGED BY THE PIECE IN FOIL

RODS 4 x 4 mm ALUMINIUM



ROD ALUMINIUM
S-BEND WIT

ROD ALUMINIUM
S-BEND ALU

MAX. 20 KG

MAX. 20 KG

ARTICLE NO.	100 cm	150 cm	200 cm	250 cm
ARTICLE NO. 100 cm	9.4277	9.4278	9.4279	9.4280
ARTICLE NO. 150 cm	9.4277	9.4278	9.4279	9.4280
ARTICLE NO. 200 cm	9.4277	9.4278	9.4279	9.4280
ARTICLE NO. 250 cm	9.4277	9.4278	9.4279	9.4280

ROD 4 x 4 mm STEEL



ROD U-TOP
STEEL WHITE

MAX. 100 KG

ARTICLE NO. 100 cm	9.4220
ARTICLE NO. 150 cm	9.4221

HOOKS



CLAMPING HOOK
40 kg

4 X 4 mm

ARTICLE NO. 9.4253

COMPATIBLE WITH ALL 4 X 4 mm RODS

HOOKS



CLAMPING HOOK
40 kg

CLAMPING HOOK
100 kg

4 x 4 mm

4 x 4 mm

ARTICLE NO. 9.4253

ARTICLE NO. 9.4255

COMPATIBLE WITH ALL 4 X 4 mm RODS

ANTI-THEFT DEVICES*



BLOCKING DEVICE
WHITE

CLAMPING HOOK STEEL
ANTI-THEFT 60 kg

CLAMPING HOOK STEEL
ANTI-THEFT 100 kg

BLOCKING SLEEVE

4 x 4 mm

4 x 4 mm

4 x 4 mm

6 x 12 x 8 mm

ARTICLE NO. 9.4290

ARTICLE NO. 9.4291

ARTICLE NO. 9.4256

ARTICLE NO. 9.4293

ALLEN KEY

ALLEN KEY

2,5 mm

2,0 mm

ARTICLE NO. 9.3390

ARTICLE NO. 9.3394

*ONLY FOR USE WITH ROD U-TOP STEEL WHITE 9.4220/9.4221/9.4222



CEILING

COMPACT
DESIGN
HIGH END

▶ PICTURE HANGING SYSTEMS

UP RAIL



The Up Rail is the leading ceiling rail par excellence; the rail is especially suitable when used in combination with concrete. The picture hanging system is clicked into place using clips (3 clips each metre) which are attached to the ceiling. The beautiful rounded shape of the rail fills the space between the wall and ceiling, therefore the picture hanging system is discrete and unobtrusive. The maximum bearing capacity of 20 kg/m makes the Up Rail a solid and reliable hanging system. The rail has a white, primed finish: the hanging rail can be painted in any preferred colour (for example, in the colour of the wall or ceiling). The Twister hanging wires can be clicked anywhere along the rail. If a ceiling mounting is required, for example if the walls may not be damaged or because it is not possible to attach a rail to the walls, the Up Rail is the ideal solution for flexible adornment of the walls.

RAIL



UP RAIL WHITE RAL 9016

ARTICLE NO. 200 cm	05.06200
ARTICLE NO. 300 cm	05.06300

FASTENER KIT WHITE

ARTICLE NO. 200 cm	4098
ARTICLE NO. 300 cm	4099



installation video

CONTENT FASTENER KIT

		QUANTITY 200 cm	QUANTITY 300 cm
05.06010	CLICK&CONNECT	6x	9x
9.4929	SCREW	6x	9x
9.4931	PLUG	6x	9x
05.06020	SET END CAPS L&R	2x	2x
2563	INSTRUCTION	1x	1x

ALL MOUNTING MATERIALS MAY BE ORDERED SEPERATELY, SEE PAGE 38



Credits: @ohmariemag / ohmarie.nl

TOP RAIL



20
KG/M

10
YEAR
WARRANTY

8 SCREWS / M

The flexible picture hanging system Top Rail is mounted to the ceiling. This ceiling rail that is discreet in its dimensions is an ideal hanging system to use in combination with recessed ceilings. By mounting the ceiling rail to the wooden side strip of a recessed ceiling, the rail 'disappears' into the ceiling. This 'invisible' picture hanging system then offers a flexible way to hang, change and replace pictures and wall decorations throughout the entire room.

RAIL



TOP RAIL - WHITE RAL 9003

TOP RAIL - ALU ANODISED

TOP RAIL - BLACK ANODISED

	TOP RAIL - WHITE RAL 9003		TOP RAIL - ALU ANODISED	TOP RAIL - BLACK ANODISED	
	P/1*	P/10*	P/10*	P/1*	P/10*
ARTICLE NO. 200 cm	9.4309	9.4326	9.4313	9.4378	9.4323
ARTICLE NO. 300 cm	9.4310	9.4327	9.4314	9.4379	9.4324
ARTICLE NO. 600 cm	-	9.4362	-	-	9.4367
	FASTENER KIT WHITE		FASTENER KIT GREY	FASTENER KIT BLACK	
ARTICLE NO. 200 cm	4070		4069	4068	
ARTICLE NO. 300 cm	4077		4076	4075	

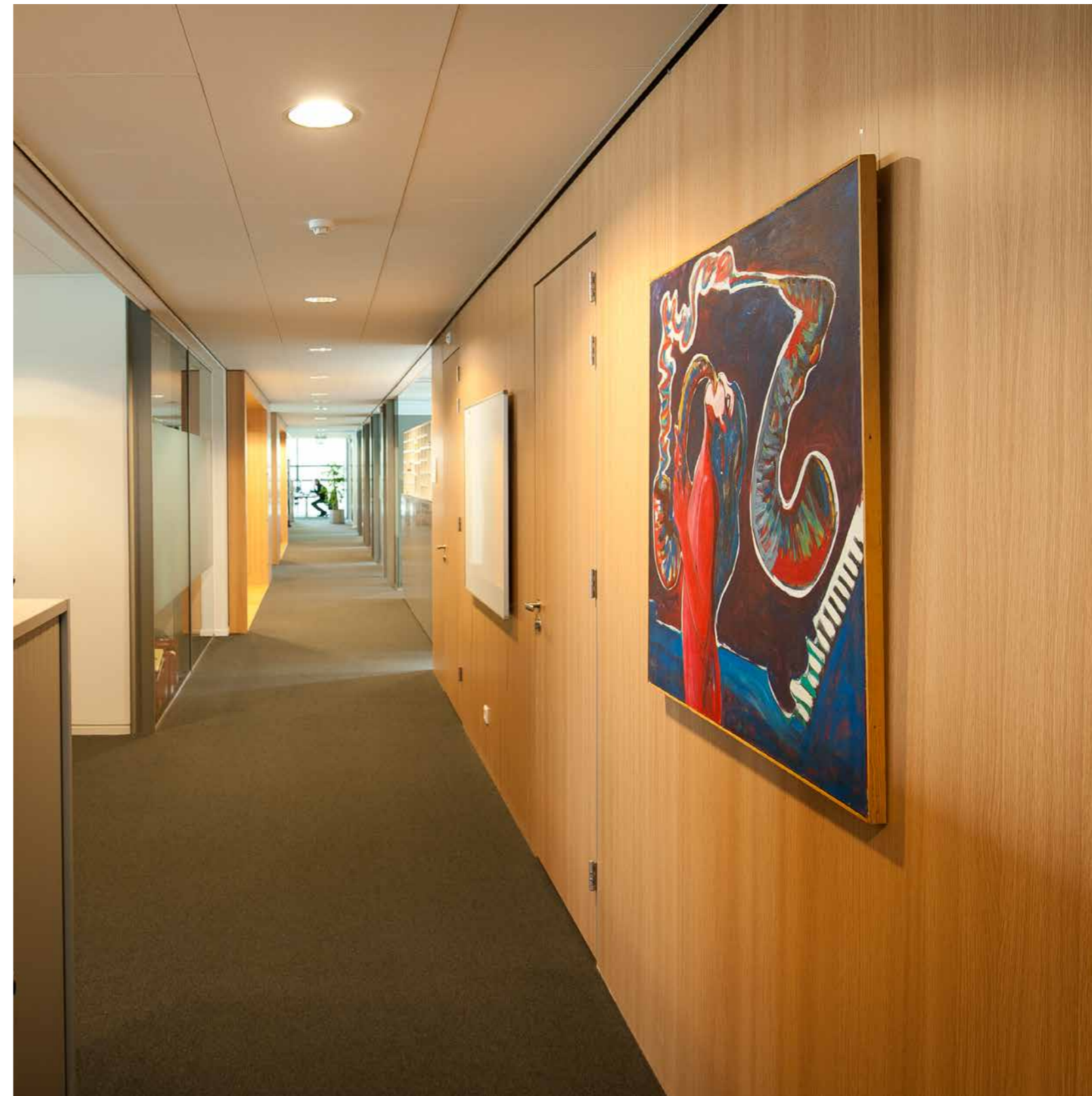

CONTENT FASTENER KIT



			QUANTITY 200 cm	QUANTITY 300 cm
9.4912 (WHITE) / 9.4913 (ALU) / 9.4903 (BLACK)	SCREW		16x	24x
9.4900	PLUG 4 mm		16x	24x
2390	INSTRUCTION		1x	1x

ALL MOUNTING MATERIALS MAY BE ORDERED SEPARATELY. SEE PAGE 38 - 8 SCREWS /m
* P/1: PACKAGED BY THE PIECE IN FOIL / P/10 PACKAGED PER 10 IN FOIL

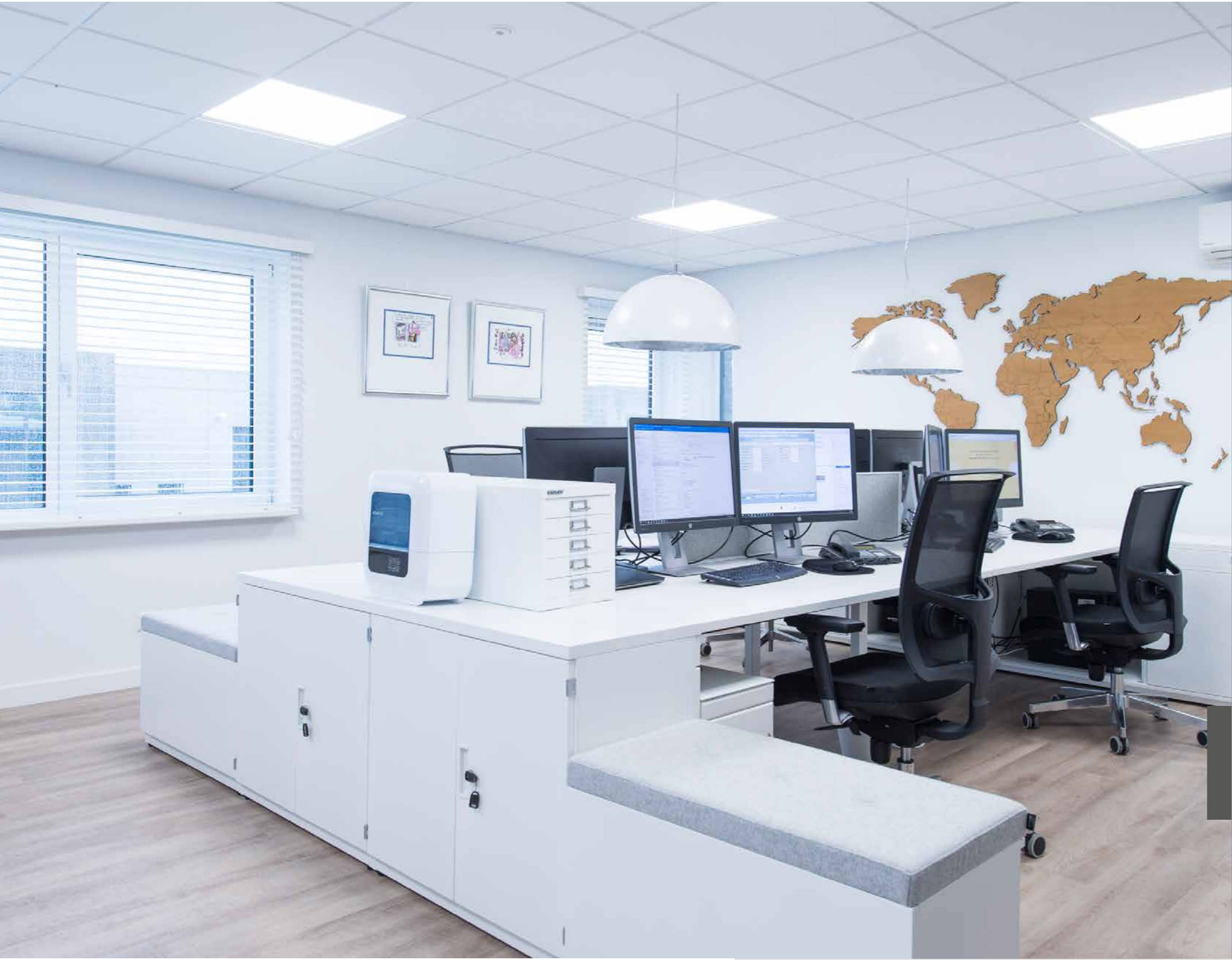

INTEGRATED

DISCRETE
FLEXIBLE
DESIGN

▶ **PICTURE HANGING SYSTEMS**

DECO RAIL / DECO RAIL LED / ART STRIP

DECO RAIL

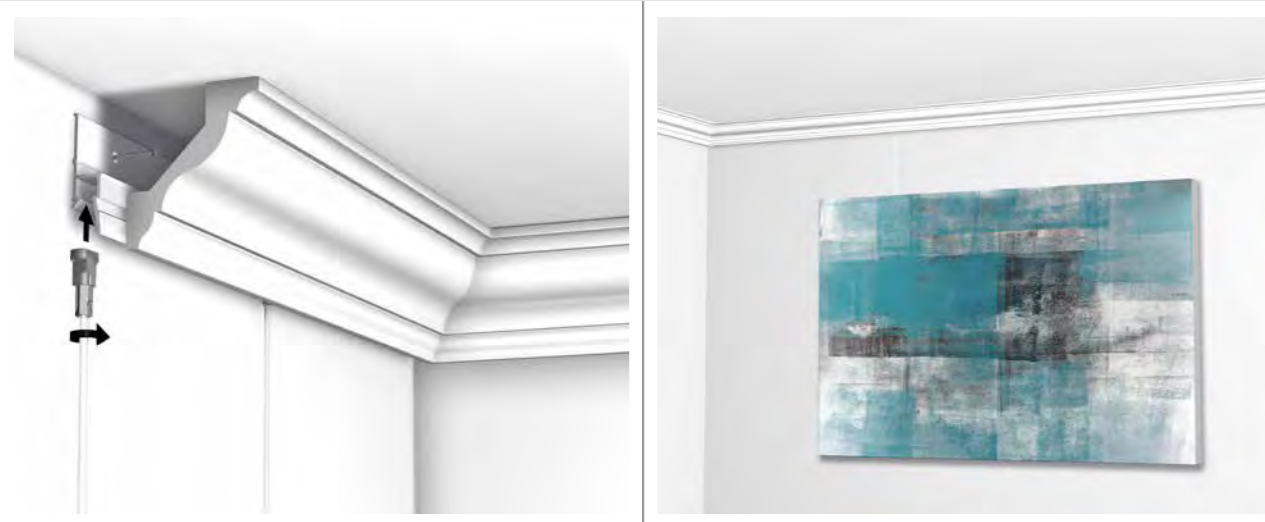

DECO RAIL LED



ART STRIP (IN COMBINATION WITH RECESSED CEILINGS)

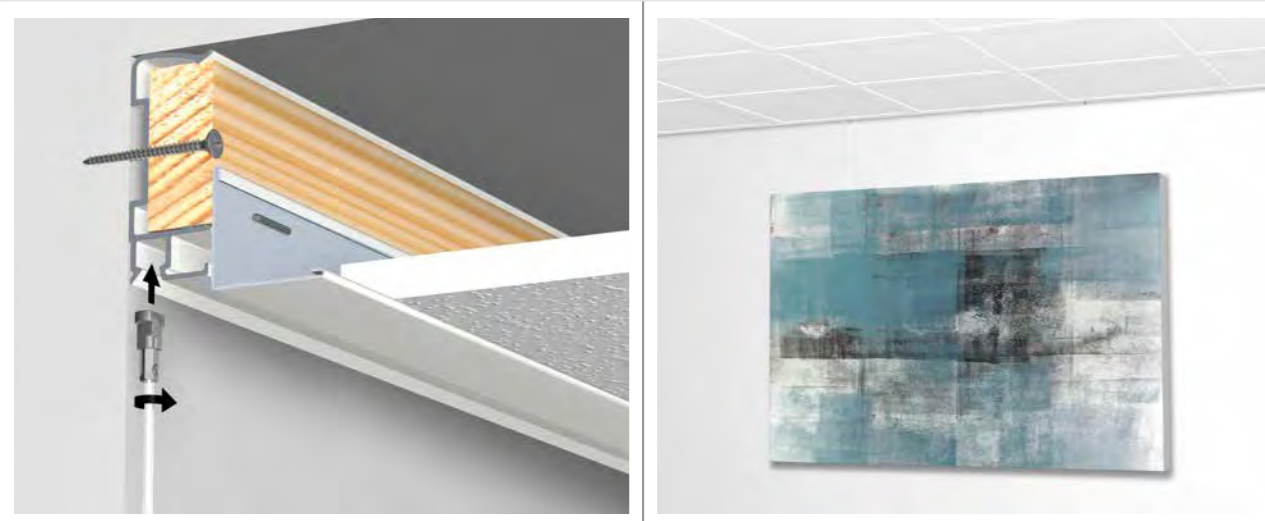

CEILING STRIP / SHADOWLINE

CEILING STRIP (IN COMBINATION WITH RECESSED CEILINGS)

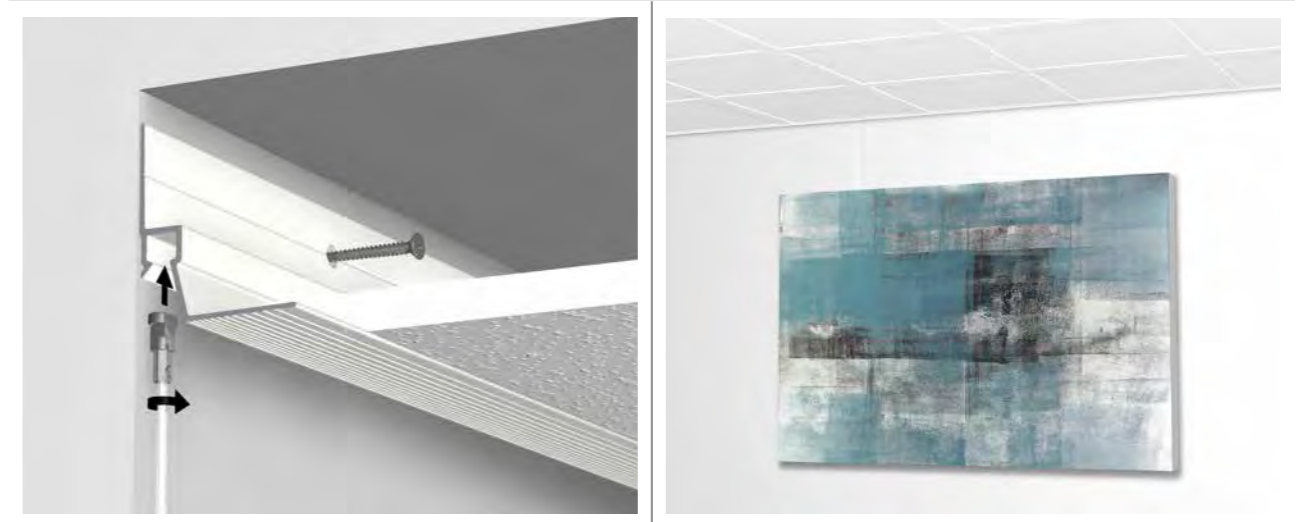

SHADOWLINE DRYWALL (IN COMBINATION WITH DRYWALL)

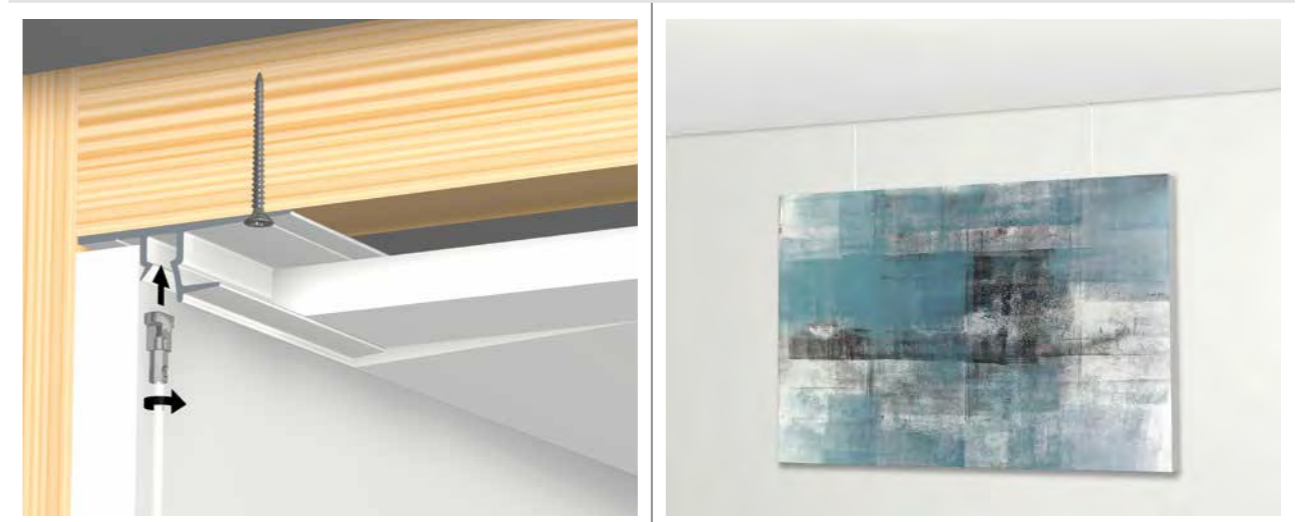

SHADOWLINE MASONRY (IN COMBINATION WITH DRYWALL)

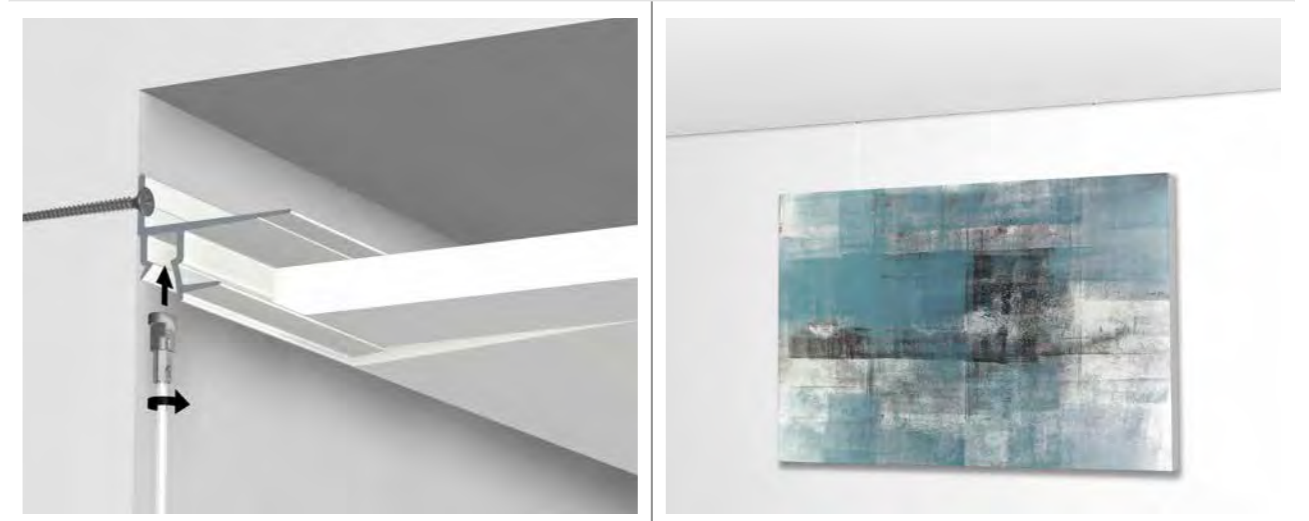

DECO RAIL

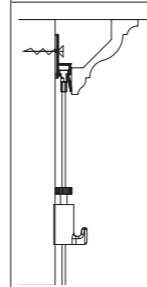
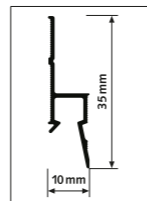

20
KG/M

10
YEAR
WARRANTY



4 SCREWS / M



Flexible options for smooth walls with Deco Rail

The Deco Rail is a hanging rail for pictures and wall decorations that is mounted behind a cornice. The hanging system becomes invisible as a result, while still offering all the advantages of a flexible hanging system. Walls with a clean, smooth finish remain undamaged, even though it is still possible to hang and move paintings continually. Hanging wires may be clicked into the rail behind the cornice at any desired location. This is the major benefit of the Deco Rail; flexibility and a guarantee for a high-quality finish. There are many different styles of cornice rails, and this hanging rail can be installed behind every type. The Deco Rail is available in combination with a selection of three different types of cornices: Basic, Modern and Classic.

RAIL / CORNICE MOULDINGS

DECO RAIL - WHITE/PRIMER RAL 9016	CX 110 BASIC	CX 126 MODERN	C 213 T CLASSIC	
ARTICLE NO. 200 cm	05.75100	05.75110	05.75126	05.75213
MOULDING DIMENSIONS		4 x 4,5 x 200 cm	9 x 9 x 200 cm	8 x 8 x 200 cm

FASTENER MATERIAL

80 ml (for 40 m)	310 ml (for 7,8 m)			
FX210 GLUE	FDP500 GLUE	PLUG FISCHER 5 X 30 R UNIVERSAL 5 mm	SCREW 3,5 x 45 mm	
FOR CONNECTING JOINTS	WALL AND CEILING			
ARTICLE NO.	1015	1016	9.4931	9.4929
				4 SCREWS / m



Credits: @suuzann_

DECO RAIL LED



20
KG/M

10
YEAR
WARRANTY



4 SCREWS / M

Invisible hanging system with subtle indirect lighting

The Deco Rail LED is a hanging system and lighting profile, with subtle indirect LED lighting in one. With the lighting profile C362 by ORAC, you add indirect lighting by diffusing light from the wall. A modern, ambient finish within the interior. Combining the Deco Rail with the lighting profile results in an invisible hanging system and allows flexible adornment of the walls. With no damage to sleekly finished walls, pictures can be hung and moved around whenever you please. Hanging wires can be clicked anywhere along the rail behind the lighting profile. The indirect lighting profile is supplied without the LED.

RAIL / LIGHTING PROFILE



DECO RAIL - WHITE/PRIMER
RAL 9016



C362 LIGHTING PROFILE

ARTICLE NO. 200 cm	05.75100	05.75362
PROFILE DIMENSIONS	5 x 5 x 200 cm	

FASTENER MATERIAL



GLUE FOR DECO RAIL LED

FDP700 DECOFIX POWER 290 ML



PLUG FISCHER 5 X 30 R
UNIVERSAL 5 mm



SCREW 3,5 x 45 mm

ARTICLE NO.	1017	9.4931	9.4929
			4 SCREWS / m



ART STRIP



50
KG/M

10
YEAR
WARRANTY

Hanging rail integrated in side strip - suitable for recessed ceilings using a side strip

The Art Strip is the picture hanging system that may be hidden in a recessed ceiling. It replaces the side strip which is used for the installation of recessed ceilings. During a tear-down phase or renovation work, the Art Strip can be installed at the same time as the recessed ceiling. The corner profile for the recessed ceiling is then mounted to the Art Strip. When you mount the Art Strip during the installation of recessed ceilings, you will have a picture hanging system available throughout the entire space, giving you a flexible way to decorate the walls. The Twister hanging cords may be clicked into any desired location in the rail next to the recessed ceiling.

RAIL

ART STRIP - WHITE RAL 9010 ART STRIP - BLACK

ARTICLE NO. 300 cm 05.08310 05.07310



CEILING STRIP



50
KG/M

10
YEAR
WARRANTY

4 SCREWS / M

Hanging rail integrated in corner profile - suitable for recessed ceilings that don't use a side strip

When recessed ceilings are installed during a building project without side strips, then the Ceiling Strip offers many benefits. The Ceiling Strip replaces the corner profile used in recessed ceilings, and at the same time, creates a completely invisible picture hanging system. When this ceiling system is installed, the only element that is visible is a discreet shadow line along the edge of the recessed ceiling where the flexible picture hanging system is hidden. This shadow line can also camouflage any imperfections in the wall, such as those masked by a side strip. Thanks to the integration of the corner bracket and hanging system, the Twister gliders on the hanging cord also disappear completely into the ceiling: the hanging system is fully integrated and not visible.

RAIL

CEILING STRIP - WHITE RAL 9010 CEILING STRIP WHITE PRIMER RAL 9016

ARTICLE NO. 300 cm 05.08320 05.08330

FASTENER MATERIAL	
	ARTICLE NO.
FISCHER UX 5 x 30 R UNIVERSAL PLUG 5 mm	9.4931
SCREW 3,5 mm x 45 mm	9.4929
SCREW METAL STUD 3,5 mm x 38 mm	9.4928
4 SCREWS PER m	



SHADOWLINE

DRYWALL - FIXATION DRYWALL



20
KG/M

10
YEAR
WARRANTY

Hanging rail for plasterboard ceilings and walls (drywall)

The Shadowline rail - drywall enables the placement of an invisible picture hanging system between plasterboard walls and ceiling panels. A discreet shadow line is the only element that appears between the wall and ceiling, and this is where the flexible picture hanging system is hidden. It is possible to install a hanging cord in the rail, anywhere you like in the room. Since the rail itself isn't visible, the hanging cords are suspended directly from the ceiling. If you choose the transparent perlon hanging cords for the rail, you will have the most discreet picture hanging system at your disposal. Using the Shadowline ceiling system means you will always have a guarantee of smooth, clean walls, and the flexibility to decorate them any way you like, without the need for tools.

RAIL

SHADOWLINE DRYWALL RAL 9016

ARTICLE NO. 250 cm FOR USE WITH DRYWALL 13 mm 05.08420

FASTENER MATERIAL	
	ARTICLE NO.
FISCHER LUX 5 x 30 R UNIVERSAL PLUG 5 mm	9.4931
SCREW 3,5 mm x 45 mm	9.4929

THE RAIL IS NOT PRE DRILLED



SHADOWLINE

MASONRY - FIXATION STONE WALLS



20
KG/M

10
YEAR
WARRANTY

9 SCREWS / 2,5M

Hanging rail for plasterboard ceilings and masonry walls

The Shadowline rail - masonry offers the same advantages as the plasterboard version, yet has been specially designed for use with masonry walls. The Shadowline rail is installed on a masonry wall during the building or renovation phase. The Shadowline profile disappears completely in the shadow line next to the ceiling panels, yet still offers all the advantages of a flexible hanging system: undamaged, clean walls and the flexibility to quickly and easily hang paintings and other wall decorations and move them around as desired.

RAIL

SHADOWLINE MASONRY RAL 9016

ARTICLE NO. 250 cm FOR USE WITH DRYWALL 13 mm 05.08430

FASTENER MATERIAL	
	ARTICLE NO.
FISCHER LUX 5 x 30 R UNIVERSAL PLUG 5 mm	9.4931
SCREW 3,5 mm x 45 mm	9.4929

9 SCREWS PER 2,5 m



FASTENER MATERIAL

	CLICK&CONNECT 3 CLIPS/m	CLICK&CONNECT 3 RINGS 3 CLIPS/m	FASTENING CLIP ROUND 3 CLIPS/m	CLICK&CONNECT 3 CLIPS/m	CLICK&CONNECT 3 CLIPS/m	CLICK&CONNECT 3 CLIPS/m
	9.4113	9.4119	9.4106	9.4124	30.31110	05.06010
+ advised o possible						
CONTOUR RAIL P.12					+	
CLICK RAIL P.08	+	0	0			
CLICK RAIL PRO P.10				+		
UP RAIL P.22						+

	END CAP WHITE	END CAP GREY	END CAP WHITE	END CAP GREY	END CAP BLACK	END CAP WHITE	END CAP GREY	CORNER CONNECTOR WHITE	CORNER CONNECTOR GREY	CORNER CONNECTOR BLACK	CORNER CONNECTOR WHITE	CORNER CONNECTOR GREY	SET END CAPS L&R
	30.31210	30.31220	9.4105	9.4104	9.4112	9.4120	9.4121	9.4107	9.4108	9.4114	9.4122	9.4123	05.06010
+ advised o possible													
CONTOUR RAIL	+	+											
CLICK RAIL			+	+	+			+	+	+			
CLICK RAIL PRO						+	+				+	+	
UP RAIL													+

	PLUG 4 mm	FISCHER UX 5 X 30 R UNIVERSAL 5 mm	PLUG 6 mm	SCREW WHITE 3,5 mm x 45 mm	SCREW ALU 3,5 mm x 45 mm	SCREW 3,5 mm x 45 mm	SCREW METAL STUD 3,5 mm x 38 mm (FOR USE WITH METAL) (NO PLUG)	SCREW 9.4912 (WHITE) / 9.4913 (ALU) / 9.4903 (BLACK)
	9.4900	9.4931	9.4930	9.4901	9.4902	9.4929	9.4928	9.4912/13/03
+ advised o possible								
CONTOUR RAIL P.12		+	0				+	+
CLICK RAIL P.08		+	0				+	+
CLICK RAIL PRO P.10		+	0				+	+
CLASSIC RAIL P.16		+	0	+	+			
CLASSIC RAIL+ P.18		+	0	+	+			
UP RAIL P.22		+	0				+	+
TOP RAIL P.24	+							+
DECO RAIL P.30		+					+	+
CEILING STRIP P.35		+					+	+
SHADOWLINE DRYWALL P.36							+	
SHADOWLINE MASONRY P.37		+					+	

DECO RAIL / CLASSIC RAIL AND CLASSIC RAIL+ : 4 SCREWS PER m
 CLASSIC RAIL, CLASSIC RAIL+, DECO RAIL AND CEILING STRIP: 1 SCREW PER 250 mm
 SHADOWLINE MASONRY : 1 SCREW PER 300 mm
 TOP RAIL : 1 SCREW PER 125 mm

FASTENER MATERIAL

FASTENER KITS



	WHITE		WHITE PRIMER		ALU		BLACK	
	200 cm	300 cm	200 cm	300 cm	200 cm	300 cm	200 cm	300 cm
CONTOUR RAIL			30.31310	30.31330	30.31320	30.31340		
CLICK RAIL	4065	4061	4065	4061	4064	4060	5094	5095
CLICK RAIL PRO			4067	4074	4066	4073		
CLASSIC RAIL	4072	4079	4072	4079	4071	4078		
CLASSIC RAIL +	4072	4079			4071	4078		
UP RAIL			4098	4099				
TOP RAIL	4070	4077	4070	4077	4069	4076	4068	4075

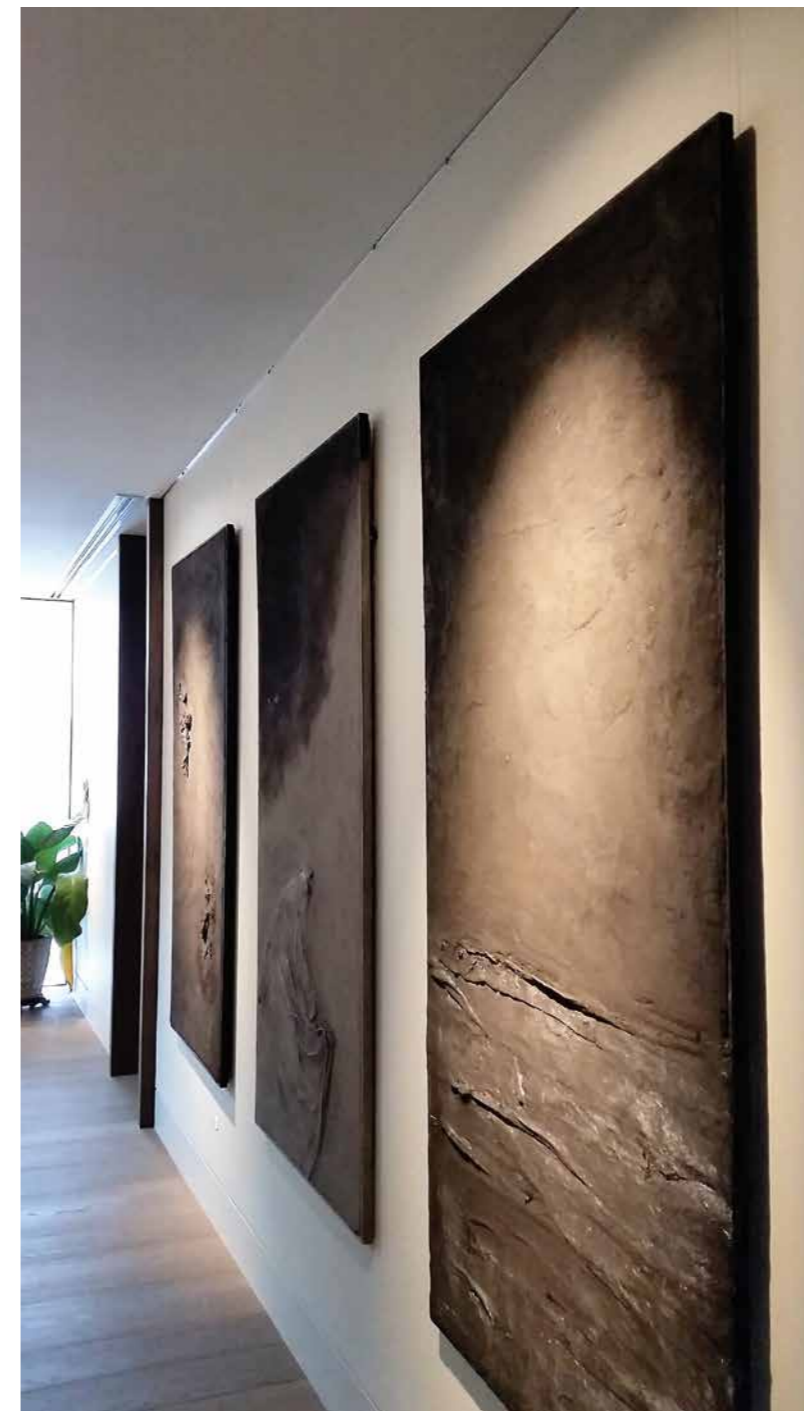

all installation videos



SOLO

FLEXIBLE
STRONG
SAFE

▶ PICTURE HANGING SYSTEMS

BOTANIQ

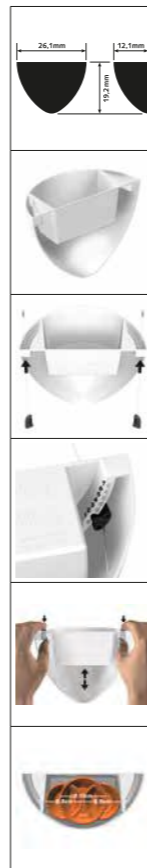

Make room for plants on the wall

There is always room for plants in your home or office. Create a surprising and dynamic effect with the Artiteq Botaniq hanging flowerpot. Hang your plants optimally with the stylish Botaniq with soft round shapes. The Botaniq comes with two 1mm perlon Twister hanging wires and two Micro Grip hooks, so you can easily hang it at the right height within Artiteq's hanging rail. The Botaniq hanging flowerpot can only be used in combination with a picture hanging rail. Choose your color and combine with several other hanging pots at different heights to give your interior an urban jungle and natural touch!

BOTANIQ COMPLETE SET

		 2X	 2X	 1x
WHITE	GREEN	MICRO GRIP 1mm	TWISTER PERLON 1mm 150cm	BOTANIQ HANGING FLOWERPOT WHITE / GREEN
ARTICLE NO. 7600.110	7600.120			

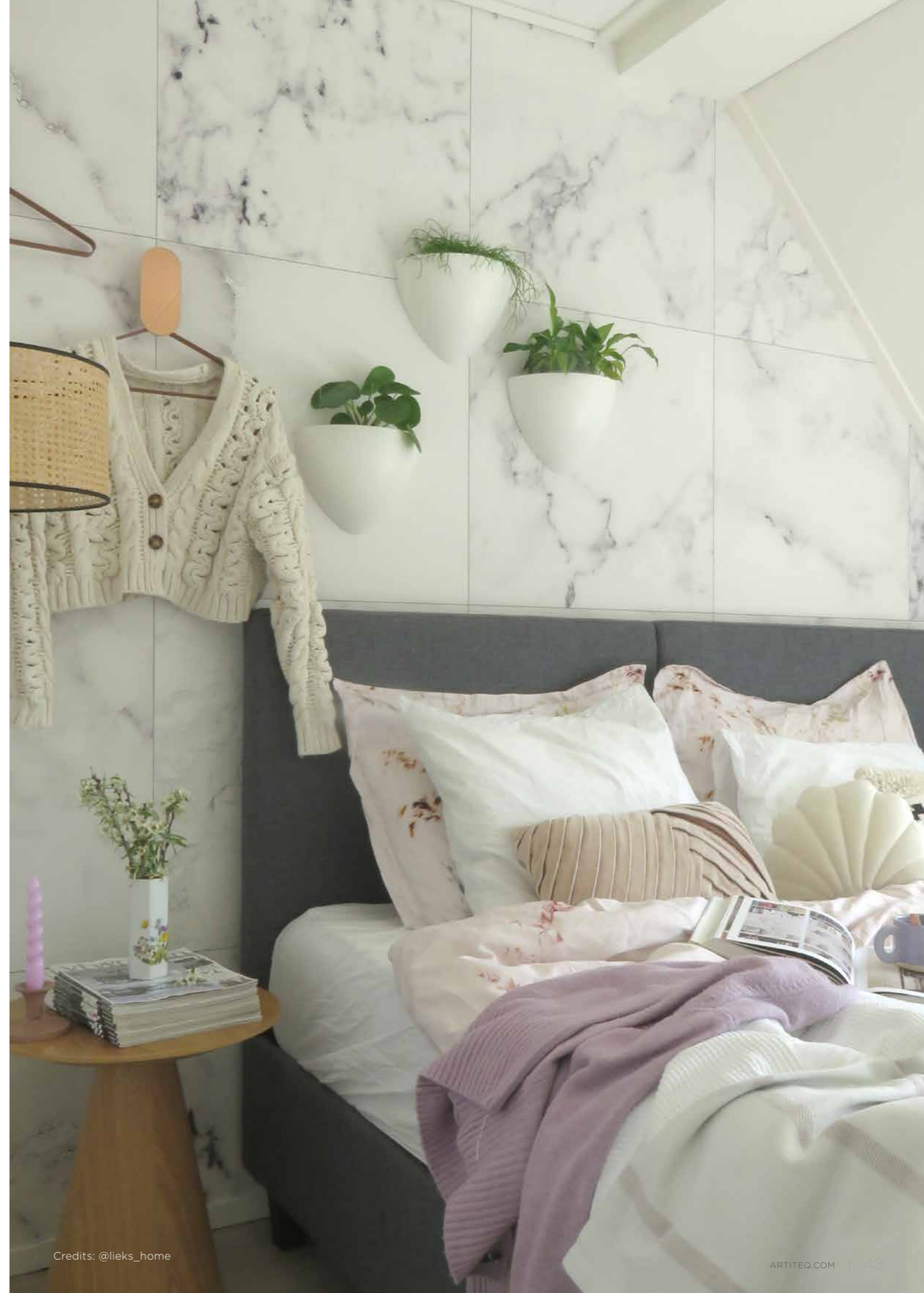

UNIQ HANGER

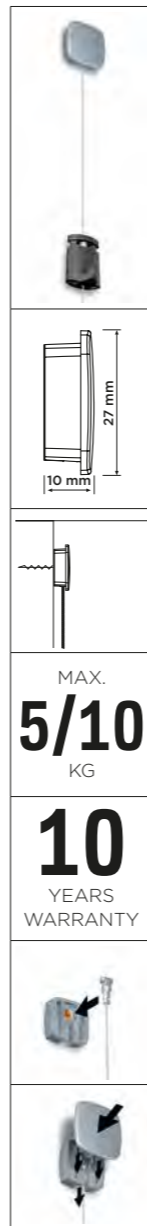

A different way to hang wall decorations

In some spaces, it either isn't possible or desirable to use a hanging rail. The Uniq Hanger offers a solution for these situations. Not only is it easy and safe to hang a picture frame on the wall and easily adjust the height, but it also creates a certain look. The combination of the stainless steel button with the steel wire might result in just the look you want to create in an interior. You also have the option of fully concealing the system behind your photo frame or painting.

Hanging a frame without a rail

The Uniq Hanger consists of a wall fitting with cover, Twister 1 mm steel wire and a Micro Grip 1 mm suspension hook. It's easy to insert the steel wire in the wall fitting, and then just slide the stainless steel cover over this. After you slide the Micro Grip 1 mm over the steel wire, you can adjust the height. The Uniq Hanger may also be used with perlon hanging wires.

UNIQU HANGER		
		
ø 6mm	max. 10 kg	max. 5 kg
UNIQU HANGER INCLUDES FASTENER MATERIAL	SET UNIQU HANGER TWISTER 1 mm STEELWIRE 200 cm + MICRO GRIP 1 mm	SET UNIQU HANGER TWISTER 1 mm PERLON 200 cm + MICRO GRIP 1 mm
ARTICLE NO. 7805.042	7840.220	7840.240

DISPLAY IT SOLO SET

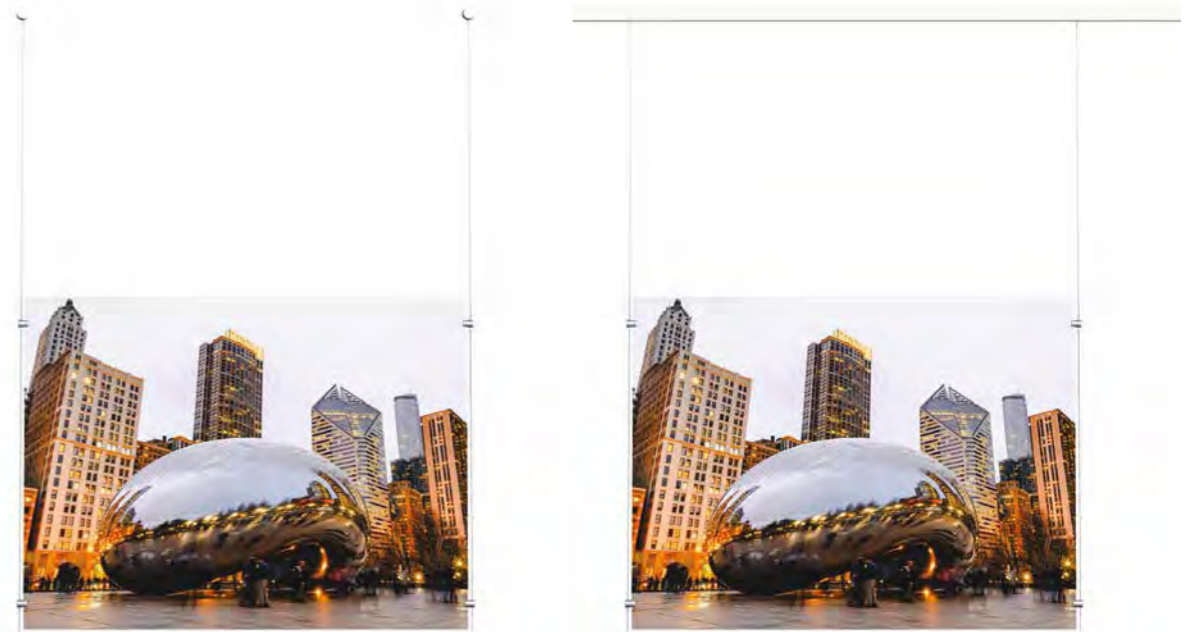

A sleek hanging system for walls

Display It Solo Set is a hanging system for plates with thicknesses ranging from 3 to 6 mm, making it ideal for hanging Plexiglas and acrylic plates. With this system photos can be displayed in a sleek and safe way on the wall. Display It Solo Set is a display system that is easy to mount to the wall. The system consists of 2 buttons that are mounted to the wall, and then the Twister hanging cords are then Twister hanging cords hooked into them. Using the 4 clamps, you then attach the acrylic or Dibond plate to the perlon wire. This display system may also be used in combination with our hanging rails.

DISPLAY IT SOLO SET				
				
	4x	2x	2x	2x
	CLAMP 3-6 mm	WALL CLIP + COVER WHITE	FASTENER MATERIAL	TWISTER 2 mm PERLON
		KUNSTSTOF		200 cm
ARTICLE NO. 7840.150	7805.030	7805.040	9.4929 / 9.4930 / 9.3394	09.23200

PARTITION WALL HOOKS



HOOKS



PARTITION WALL HOOK			
SIZE	16 mm	21 mm	31 mm
COLOUR	WHITE	WHITE	WHITE
MAX. CAPACITY	15 kg	15 kg	15 kg
ARTICLE NO.	9.4503	9.4504	9.4506

HANGING WIRES



9.4424	SLIDER + PERLON	2 mm	100 cm
9.4425	SLIDER + PERLON	2 mm	150 cm
9.4426	SLIDER + PERLON	2 mm	200 cm
9.4427	SLIDER + PERLON	2 mm	250 cm
9.4428	SLIDER + PERLON	2 mm	300 cm



MICRO GRIP 2 mm
30.41200 | 20 kg



MICRO GRIP LOCK 2 mm
30.41250 | 20 kg

FOR OVERVIEW HOOKS AND HANGING SETS SEE PAGE 58-65

Flexible and solid

Since it is not always possible (or allowed) to hang rails in every room, we also offer solutions for hanging pictures and wall decorations in the form of partition wall hooks. We offer a range of various types of partition wall hooks for rooms with partitions, giving you a solid, practical way to hang pictures and decorations even on these types of walls. Partition wall hooks are hung over the top of a wall, and then used in combination with a perlon or other type of cord fitted with a picture hook. We offer a variety of solutions depending on the weight of the picture or decoration to be hung.

HOOKS



PARTITION WALL HOOK			PARTITION WALL HOOK FLEX		
SIZE	16 mm	21 mm	31 mm	11-30 mm	
COLOUR	WHITE	WHITE	WHITE	STAINLESS STEEL	WHITE
MAX. CAPACITY	15 kg	15 kg	15 kg	3 kg	3 kg
ARTICLE NO.	9.4503	9.4504	9.4506	9.4540	9.4541

HOOKS



S-HOOK		GALLERY HOOK		GALLERY HOOK LARGE			
SIZE	2 mm	18 mm		20 mm			
COLOUR	WHITE	WHITE	NICKEL-PLATED	BRASS	WHITE	NICKEL-PLATED	BRASS
MAX. CAPACITY	20 kg	12,5 kg	12,5 kg	12,5 kg	20 kg	20 kg	20 kg
ARTICLE NO.	9.4500	9.4239	9.4238	9.4241	9.4247	9.4246	9.4248

HANGING WIRES



9.4412	PERLON + LOOP	2 mm	100 cm
9.4413	PERLON + LOOP	2 mm	150 cm
9.4414	PERLON + LOOP	2 mm	200 cm
9.4415	PERLON + LOOP	2 mm	250 cm
9.4416	PERLON + LOOP	2 mm	300 cm
9.4975	STEELWIRE + LOOP	2 mm	100 cm
9.4976	STEELWIRE + LOOP	2 mm	150 cm
9.4977	STEELWIRE + LOOP	2 mm	200 cm
9.4978	STEELWIRE + LOOP	2 mm	250 cm
9.4979	STEELWIRE + LOOP	2 mm	300 cm



MICRO GRIP 2 mm
30.41200 | 20 kg



MICRO GRIP Lock 2 mm
30.41250 | 20 kg

FOR MORE HOOKS SEE PAGE 58

MAGNETIC PICTURE HOOKS



7410.001	MAGNETIC PICTURE HOOK STEEL	100 x 53 mm	MAX. 1 kg
7410.002	MAGNETIC PICTURE HOOK STEEL	100 x 200 mm	MAX. 4 kg
7410.003	MAGNETIC PICTURE HOOK STEEL	150 x 250 mm	MAX. 6 kg
7410.004	MAGNETIC PICTURE HOOK STEEL	200 x 300 mm	MAX. 12 kg



ALL-IN-ONE
KITS

COMPACT
DESIGN
HIGH END

▶ PICTURE HANGING SYSTEMS

CLICK RAIL

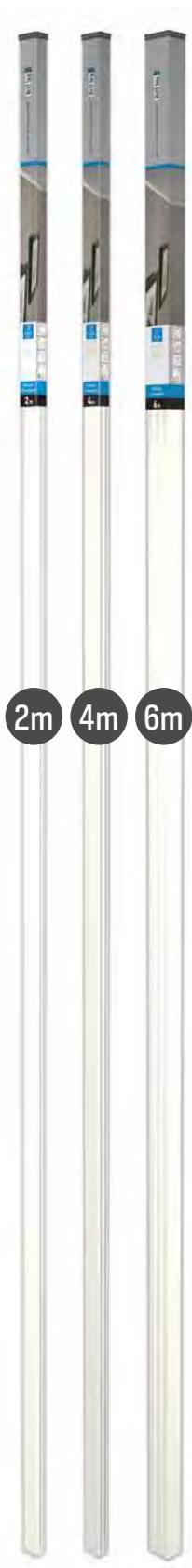

The Click Rail flexible picture hanging system is available in a variety of all-in-one kits: economy, a Twister with a 15-kg hook and a Twister with a 20-kg Micro Grip hook. These retail packages contain the rail, mounting materials and instruction sheet, hanging wires and hooks, and are available in 2-m, 4-m and/or 6-m sets. The all-in-ones kits offer a complete solution and are ready for immediate onward sale.

ALL-IN-ONE CLICK RAIL ECONOMY





COMPLETE SET 2m				
	 1x 2m	 6x	 2x	 150 cm 2x max. 4 kg
CLICK RAIL WHITE RAL 9010	FASTENING MATERIAL	END CAP	SLIDER PERLON 2 mm HOOK 4 kg	
ARTICLE NO. 9.5621				



COMPLETE SET 4m				
	 2x 2m	 12x	 2x	 150 cm 3x max. 4 kg
CLICK RAIL WHITE RAL 9010	FASTENER MATERIAL	END CAP	SLIDER PERLON 2 mm HOOK 4 kg	
ARTICLE NO. 9.5627				





COMPLETE SET 6m				
	 3x 2m	 18x	 2x	 150 cm 4x max. 4 kg
CLICK RAIL WHITE RAL 9010	FASTENER MATERIAL	END CAP	SLIDER PERLON 2 mm HOOK 4 kg	
ARTICLE NO. 9.5629				





CLICK RAIL

ALL-IN-ONE CLICK RAIL ECONOMY

COMPLETE SET 2m				
	 1x 2m	 6x	 2x	 150 cm 2x max. 4 kg
CLICK RAIL WHITE PRIMER RAL 9016	FASTENER MATERIAL	END CAP	SLIDER PERLON 2 mm HOOK 4 kg	
ARTICLE NO. 9.5623				

COMPLETE SET 4m				
	 2x 2m	 12x	 2x	 150 cm 3x max. 4 kg
CLICK RAIL WHITE PRIMER RAL 9016	FASTENER MATERIAL	END CAP	SLIDER PERLON 2 mm HOOK 4 kg	
ARTICLE NO. 9.5628				



COMPLETE SET 6m				
	 3x 2m	 18x	 2x	 150 cm 4x max. 4 kg
CLICK RAIL WHITE PRIMER RAL 9016	FASTENER MATERIAL	END CAP	SLIDER PERLON 2 mm HOOK 4 kg	
ARTICLE NO. 9.5630				





COMPLETE SET 2m				
	 1x 2m	 6x	 2x	 150 cm 2x max. 4 kg
CLICK RAIL ALU BRUSHED	FASTENER MATERIAL	END CAP	SLIDER PERLON 2 mm HOOK 4 kg	
ARTICLE NO. 9.5622				

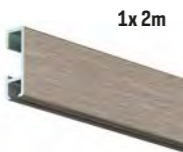

CLICK RAIL

ALL-IN-ONE CLICK RAIL TWISTER 15 KG HOOK

COMPLETE SET 2m				
	 1x 2m	 6x	 2x	 150 cm 2x max. 15 kg
	CLICK RAIL WHITE PRIMER RAL 9016	FASTENER MATERIAL	END CAP	HOOK 15 kg + TWISTER 2 mm PERLÖN
ARTICLE NO.	9.7162			



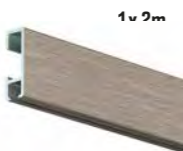

COMPLETE SET 2m				
	 1x 2m	 6x	 2x	 150 cm 2x max. 15 kg
	CLICK RAIL WHITE RAL 9010	FASTENER MATERIAL	END CAP	HOOK 15 kg + TWISTER 2 mm PERLÖN
ARTICLE NO.	9.7161			

COMPLETE SET 2m				
	 1x 2m	 6x	 2x	 150 cm 2x max. 15 kg
	CLICK RAIL ALU BRUSHED	FASTENER MATERIAL	END CAP	HOOK 15 kg + TWISTER 2 mm PERLÖN
ARTICLE NO.	9.7163			

COMPLETE SET 2m				
	 1x 2m	 6x	 2x	 150 cm 2x max. 15 kg
	CLICK RAIL ALU BRUSHED	FASTENER MATERIAL	END CAP	HOOK 15 kg + TWISTER 2 mm STEELWIRE
ARTICLE NO.	9.7164			

CLICK RAIL

ALL-IN-ONE CLICK RAIL TWISTER MICRO GRIP 20 KG HOOK

COMPLETE SET 2m				
	 1x 2m	 6x	 2x	 150 cm 2x max. 20 kg
	CLICK RAIL WHITE PRIMER RAL 9016	FASTENER MATERIAL	END CAP	MICRO GRIP 2 mm + TWISTER 2 mm PERLÖN
ARTICLE NO.	9.7130			

COMPLETE SET 4m				
	 2x 2m	 12x	 2x	 150 cm 3x max. 20 kg
	CLICK RAIL WHITE PRIMER RAL 9016	FASTENER MATERIAL	END CAP	MICRO GRIP 2 mm + TWISTER 2 mm PERLÖN
ARTICLE NO.	9.7131			

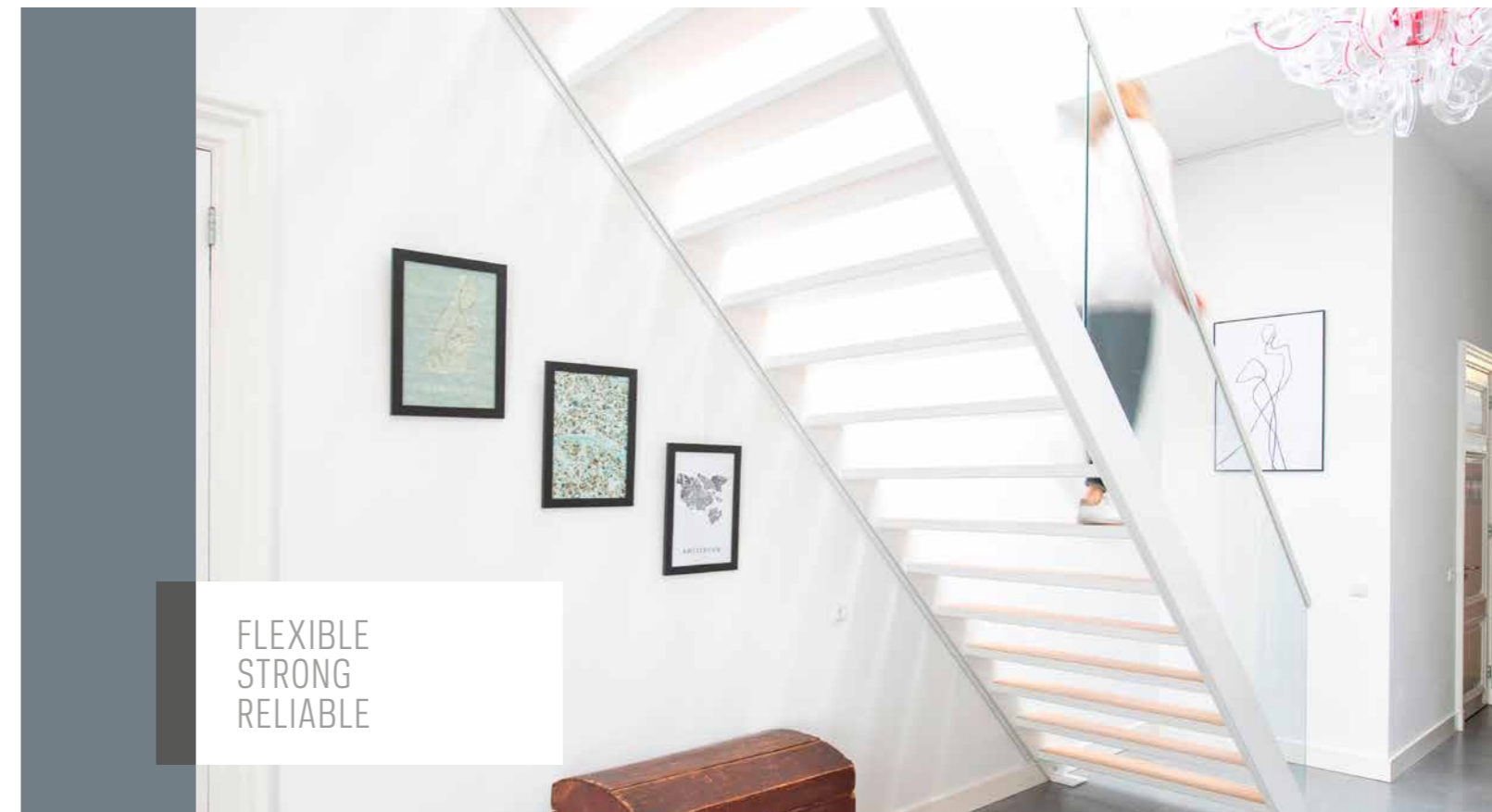

COMBI RAIL PRO LIGHT

The flexible picture hanging system, including Combi Rail Pro Light lighting, is available in 4 different all-in-one kits: 2, 4, 6 and 8 metres. As well as the rail, these sets contain all the required parts, as well as the following accessories: Twister perlon hanging wire with a Micro Grip 20-kg hook.

COMBI RAIL PRO LIGHT ALL-IN-ONE LED SETS 2m/4m/6m/8m

					
COMBI RAIL PRO LIGHT RAL 9010 (INCLUDES MOUNTING MATERIAL)	FITTING 50 cm	MASTER LED PHILIPS 6,5W	TRAF0 220/12 INCLUDES CONNECTION BLOCK	MICRO GRIP 2 mm + TWISTER 2 mm 150 cm PERLON	
ARTICLE NO.	40.11200	40.21500	40.41306	40.31300/40.32060	30.42200
40.51350 (2m)	1x	1x	1x	1x (40.32060)	1x
40.51360 (4m)	2x	2x	2x	1x/1x	2x
40.51370 (6m)	3x	3x	3x	2x/1x	3x
40.51380 (8m)	4x	4x	4x	3x/1x	4x



FLEXIBLE
DESIGN
HIGH-END

▶ HANGING WIRES AND HOOKS

FLEXIBLE
SAFE
STRONG



Credits: @huisjeboompjiefde

HANGING WIRES

TWISTER™

MAX.
20 KG

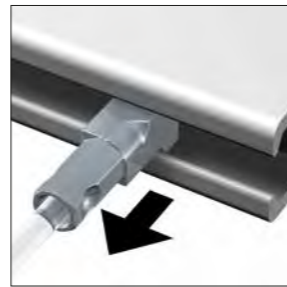
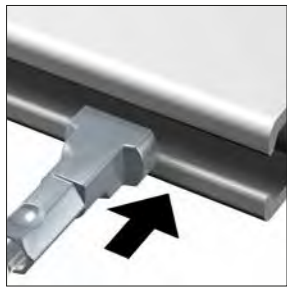

1 SIMPLE-SAFE-STRONG

Artiteq developed the Twister glider system for all its hanging rails. Twister offers the most Logical and user-friendly way to hook the hanging wire into the rail: insert, twist, click and you're done. Since the Twister may be clicked anywhere on the rail, you can hang a picture anywhere you like on the wall. You have the option of using Twister in perlon, steel wire or rods for all the Artiteq hanging systems. The perlon and steel hanging wires with the Twister mechanism are available in 1 or 2 mm thicknesses, and in lengths ranging from 100 to 500 cm.

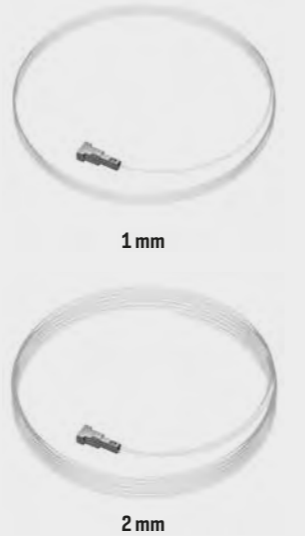

TWISTER™

Twister is a European Registered Community Design.

TWISTER™ CLIQ2FIX perlon

MAX.
20 KG



2 EXTRA EASE-OF-USE

Thanks to the development of the Twister Cliq2Fix perlon system, perlon cord now has an additional functionality when it comes to hanging pictures. The hanging wire equipped with the Twister Cliq2Fix system may be inserted in the rail, eliminating the risk of the perlon cord popping loose from the rail as a result of its recoiling effect. This makes it extra safe, and easy to slide into the rail. In other words, extra ease-of-use.



HANGING WIRES

SOLID SLIDER

MAX.
20 KG

SLIDER ECONOMY
not visible in the rail

MAX.
15 KG

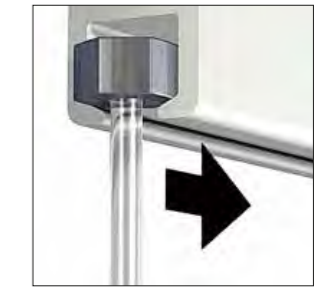
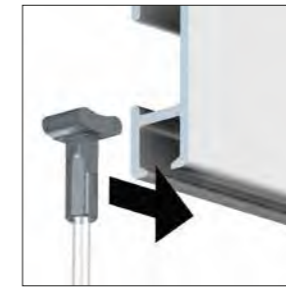
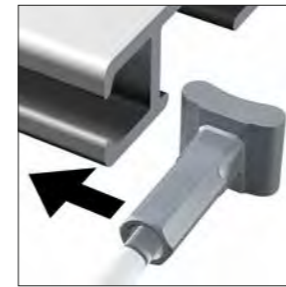

3 SLIDE INTO SIDE

Artiteq developed the Solid Slider system which attaches the hanging wire with glider via the side of the rail. This system is available for 2 mm perlon and 2 mm steel wire. The hanging wire may be freely slid into the hanging rail, yet may not be removed from the rail as easily. Hanging wires with the Solid Slider mechanism are available in lengths of 100, 150, 200, 250, 300 en 500 cm. A slanted stop system is available for slanted walls. This system makes it possible to use a flexible picture hanging system even with slanted walls, for example in a staircase.



1 mm					
TWISTER 1 mm					
30.21150	TWISTER	1 mm	PERLON	150 cm	
30.21200	TWISTER	1 mm	PERLON	200 cm	
30.21300	TWISTER	1 mm	PERLON	300 cm	
30.22150	TWISTER	1 mm	STEEL	150 cm	
30.22200	TWISTER	1 mm	STEEL	200 cm	
30.22300	TWISTER	1 mm	STEEL	300 cm	
09.63150	TWISTER	1 mm	STEEL BLACK	150 cm	
09.63200	TWISTER	1 mm	STEEL BLACK	200 cm	
09.63300	TWISTER	1 mm	STEEL BLACK	300 cm	

2 mm					
TWISTER 2 mm					
09.23100	TWISTER	2 mm	PERLON	100 cm	
09.23150	TWISTER	2 mm	PERLON	150 cm	
09.23200	TWISTER	2 mm	PERLON	200 cm	
09.23250	TWISTER	2 mm	PERLON	250 cm	
09.23300	TWISTER	2 mm	PERLON	300 cm	
09.23500	TWISTER	2 mm	PERLON	500 cm	
09.33100	TWISTER	2 mm	STEEL	100 cm	
09.33150	TWISTER	2 mm	STEEL	150 cm	
09.33200	TWISTER	2 mm	STEEL	200 cm	
09.33250	TWISTER	2 mm	STEEL	250 cm	
09.33300	TWISTER	2 mm	STEEL	300 cm	
09.33500	TWISTER	2 mm	STEEL	500 cm	
9.4196	TWISTER	2 mm	ROD WHITE	100 cm	
9.4198	TWISTER	2 mm	ROD WHITE	200 cm	

2 mm					
TWISTER CLIQ2FIX PERLON					
09.13100	TWISTER CLIQ2FIX	2 mm	PERLON	100 cm	
09.13150	TWISTER CLIQ2FIX	2 mm	PERLON	150 cm	
09.13200	TWISTER CLIQ2FIX	2 mm	PERLON	200 cm	
09.13250	TWISTER CLIQ2FIX	2 mm	PERLON	250 cm	
09.13300	TWISTER CLIQ2FIX	2 mm	PERLON	300 cm	

2 mm					
SOLID SLIDER					
08.23100	SOLID SLIDER	2 mm	PERLON	100 cm	
08.23150	SOLID SLIDER	2 mm	PERLON	150 cm	
08.23200	SOLID SLIDER	2 mm	PERLON	200 cm	
08.23250	SOLID SLIDER	2 mm	PERLON	250 cm	
08.23300	SOLID SLIDER	2 mm	PERLON	300 cm	
08.23500	SOLID SLIDER	2 mm	PERLON	500 cm	
08.43100	SOLID SLIDER	2 mm	STEEL	100 cm	
08.43150	SOLID SLIDER	2 mm	STEEL	150 cm	
08.43200	SOLID SLIDER	2 mm	STEEL	200 cm	
08.43250	SOLID SLIDER	2 mm	STEEL	250 cm	
08.43300	SOLID SLIDER	2 mm	STEEL	300 cm	
08.43500	SOLID SLIDER	2 mm	STEEL	500 cm	

HOOKS

Depending on the weight of a frame or other wall decoration, the right picture hook must be selected. The wide product range offers hooks with maximum load capacities varying from 4 kg to 20 kg.

	30.41200 20 kg AUTO GRIP	30.41250 20 kg AUTO GRIP	30.41100 10/5 kg AUTO GRIP	9.4264 15 kg AUTO GRIP	9.4261 15 kg AUTO GRIP
	LOCK			LOCK	
TWISTER 1 mm PERLON 150 / 200 / 300 cm			✓		
TWISTER 1 mm STEELWIRE 150 / 200 / 300 cm			✓		
TWISTER 1 mm STEELWIRE BLACK 150 / 200 / 300 cm			✓		
TWISTER 2 mm PERLON 100 / 150 / 200 250 / 300 / 500 cm	✓	✓		✓	✓
TWISTER 2 mm STEELWIRE 100 / 150 / 200 250 / 300 / 500 cm	✓	✓		✓	✓
TWISTER 2 mm 2 mm ROD WHITE 100 / 200 cm	✓	✓			✓
TWISTER CLIQ2FIX 2 mm PERLON 100 / 150 / 200 250 / 300 cm	✓	✓		✓	✓
SOLID SLIDER 2 mm PERLON* 100 / 150 / 200 250 / 300 / 500 cm vanaf zijkant in te brengen	✓	✓		✓	✓
SOLID SLIDER 2 mm STEELWIRE* 100 / 150 / 200 250 / 300 / 500 cm vanaf zijkant in te brengen	✓	✓		✓	✓

* SOLID SLIDER 2 mm PERLON/STEELWIRE ARE NOT ADVISED FOR CEILING SYSTEMS AND INTEGRATED SYSTEMS

	9.4208 10 kg MANUAL	9.4219 7 kg MANUAL	9.4209 7 kg MANUAL	9.4207 5 kg MANUAL	9.4205 4 kg MANUAL
TWISTER 2 mm PERLON 100 / 150 / 200 250 / 300 / 500 cm	✓	✓	✓	✓	✓
TWISTER 2 mm ROD WHITE 100 / 200 cm				✓	
TWISTER CLIQ2FIX 2 mm PERLON 100 / 150 / 200 250 / 300 cm	✓	✓	✓	✓	✓
SOLID SLIDER 2 mm PERLON* 100 / 150 / 200 250 / 300 / 500 cm vanaf zijkant in te brengen	✓	✓	✓	✓	✓

* SOLID SLIDER 2 mm PERLON/STEELWIRE ARE NOT ADVISED FOR CEILING SYSTEMS AND INTEGRATED SYSTEMS

The maximum weight carrying capacity of a picture hook is only valid when the frame is correctly applied to the hook. This illustration shows how to correctly charge the picture hook.

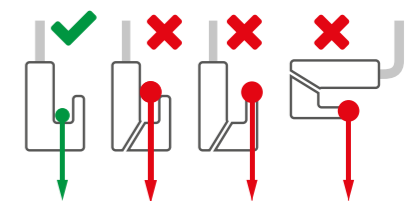



Micro Grip represents the newest generation of hooks. A high-quality plastic reinforced with fibreglass was chosen for this hook, leading to a 70% reduction in the use of materials compared with previous generations of hooks. In addition to the ecological advantages, the hook is extremely lightweight as a result, and very easy to use. The **Micro Grip** technology has been developed and patented by Artiteq. To guarantee the quality of the **Micro Grip** hooks, Artiteq has developed quality assurance procedures together with TÜV Nederland. The execution is under supervision of TÜV Nederland.







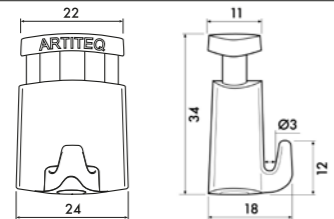

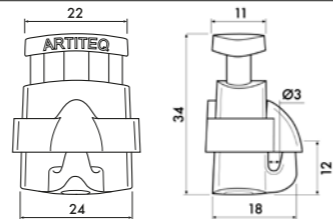
- LIGHTWEIGHT
- STRONG (20 kg)
- ERGONOMIC

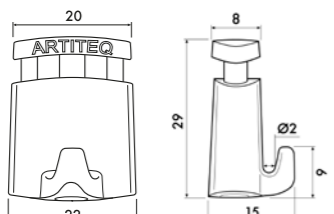

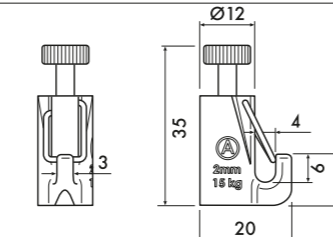



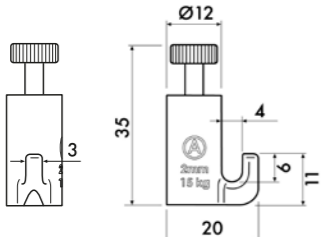

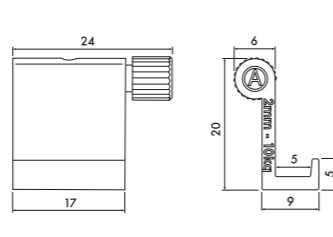
HOOKS

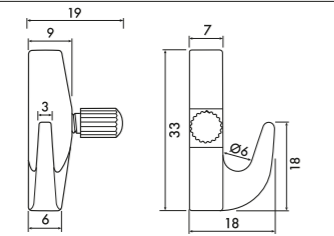
  <p>30.41200 20 kg AUTO GRIP</p>	  <p>30.41250 20 kg AUTO GRIP</p>
--	---

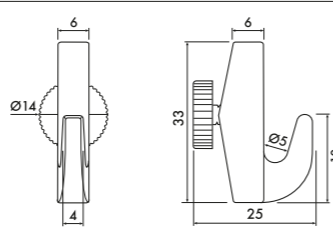
  <p>30.41100 10/5 kg AUTO GRIP</p>	  <p>9.4264 15 kg AUTO GRIP</p>
--	---

  <p>9.4261 15 kg AUTO GRIP</p>	  <p>9.4208 10 kg MANUAL</p>
---	---

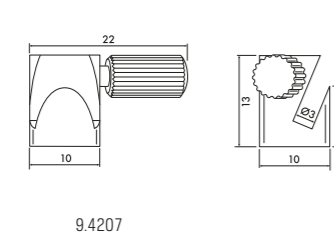
  <p>9.4219 7 kg MANUAL</p>	  <p>9.4209 7 kg MANUAL</p>
--	---

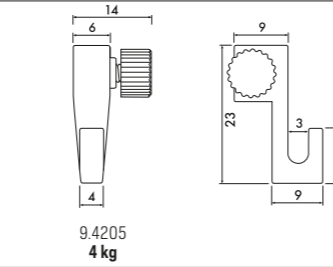
  <p>9.4207 5 kg MANUAL</p>	  <p>9.4205 4 kg MANUAL</p>
--	---

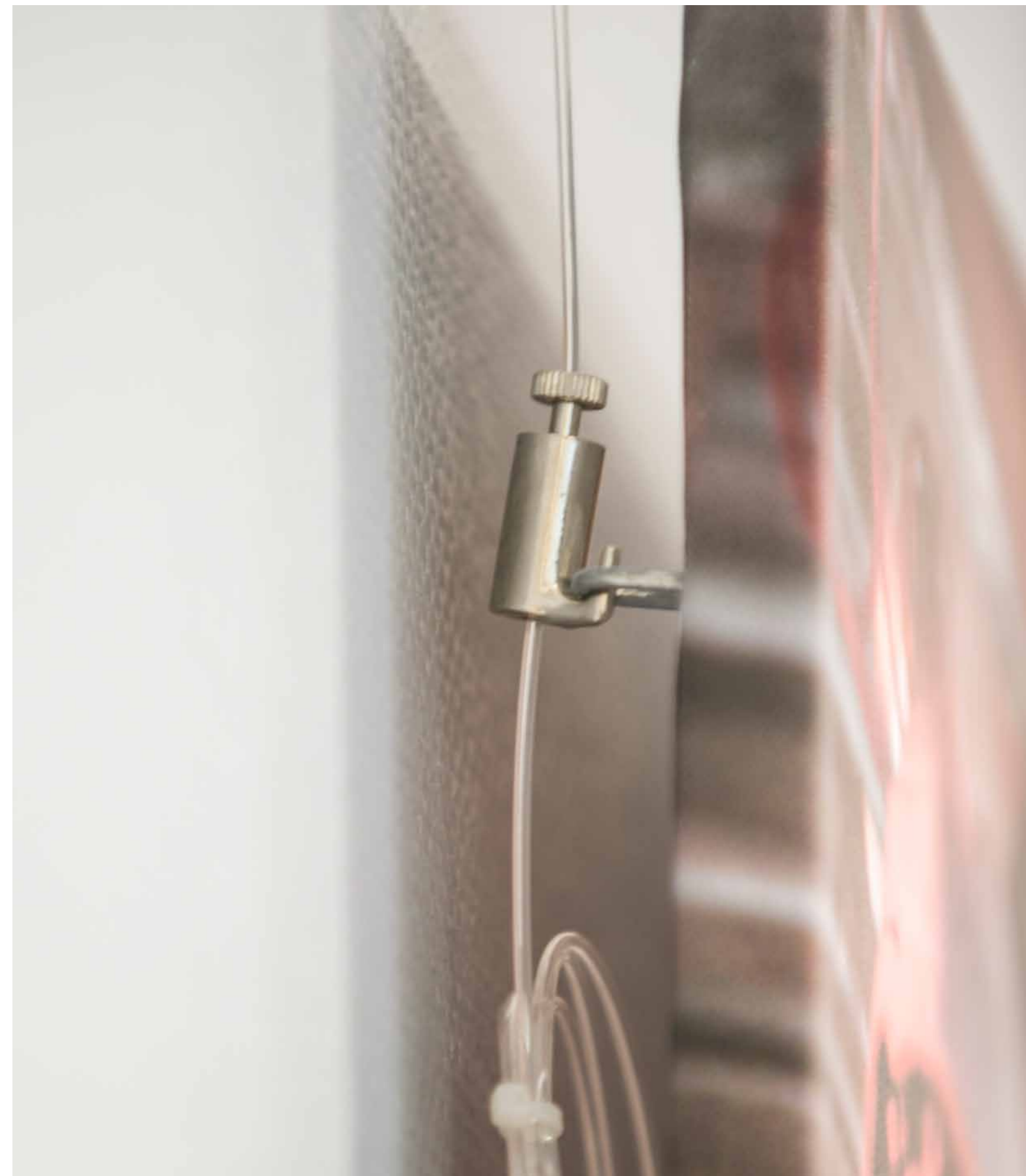

COMBINATIONS

A picture hanging system comprises the following elements: **rail**, **hanging wire** and **hanging hook**. Artiteq guarantees the functionality of the products because it carefully coordinates the various elements of a picture hanging system. The quality can only be guaranteed when original (Artiteq) products are combined correctly. The guarantee is null and void if there are combinations other than with the correct Artiteq products. A frame or canvas will always hang more steadily if **2 hanging wires** are used.

The weight of the frame determines the choice of the hook and wire, in combination with the maximum weight carrying capacity of one metre of the rail.

INCORRECT COMBINATIONS

CORRECT COMBINATIONS

HANGING SETS

HANGING SETS 1 mm			HANGING SETS 2 mm			
max. 10 kg	max. 5 kg	max. 20 kg	max. 4 kg	max. 7 kg	max. 15 kg	max. 5 kg
TWISTER 1 mm STEELWIRE 150 cm + MICRO GRIP 1 mm (10 kg)	TWISTER 1 mm PERLON 150 cm + MICRO GRIP 1 mm (5 kg)	TWISTER 2 mm PERLON 150 cm + MICRO GRIP 2 mm (20 kg)	TWISTER 2 mm PERLON 150 cm + HOOK 9.4205 (4 kg)	TWISTER 2 mm PERLON 150 cm + HOOK 9.4209 (7 kg)	TWISTER 2 mm PERLON 150 cm + HOOK 9.4261 (15 kg)	TWISTER 2 mm PERLON 150 cm + HOOK 9.4207 (5 kg)
HANGING SET	HANGING SET	HANGING SET	HANGING SET	HANGING SET	HANGING SET	HANGING SET
30.42150	30.42100	30.42200	9.6670	9.6672	9.6674	9.6671

HANGING SETS 2 mm			STOPPER SET SLANTING WALLS	
max. 4 kg	max. 7 kg	max. 5 kg	max. 4 kg	
SLIDER 2 mm PERLON 150 cm + HOOK 9.4205 (4 kg)	SLIDER 2 mm PERLON 150 cm + HOOK 9.4209 (7 kg)	SLIDER 2 mm PERLON 150 cm + HOOK 9.4207 (5 kg)	SOLID SLIDER 2 mm PERLONWIRE 150 cm + HOOK 9.4205 (4 kg) + STOPPER SLANTING WALLS	STOPPER SLANTING WALLS
HANGING SET	HANGING SET	HANGING SET	HANGING SET	
9.9004	9.4402	9.4400	9.6645	9.4235

MISCELLANEOUS

TWISTER HOOK

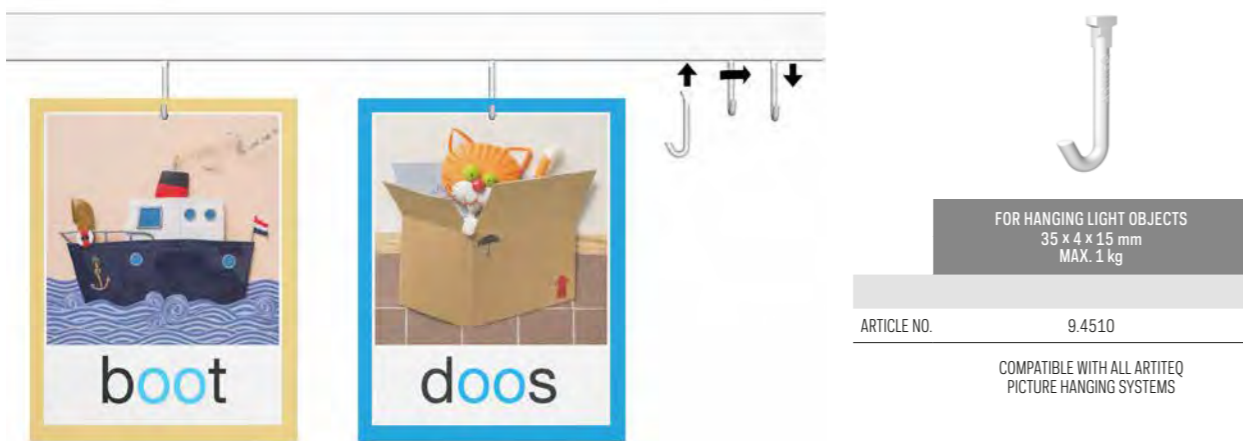

FOR HANGING LIGHT OBJECTS
35 x 4 x 15 mm
MAX. 1 kg

ARTICLE NO. 9.4510

COMPATIBLE WITH ALL ARTITEQ
PICTURE HANGING SYSTEMS

Instead of a hanging wire and hook, a Twister Hook can be used. This plastic hook can provide an inexpensive and practical solution for hanging light panels in combination with a picture hanging system.

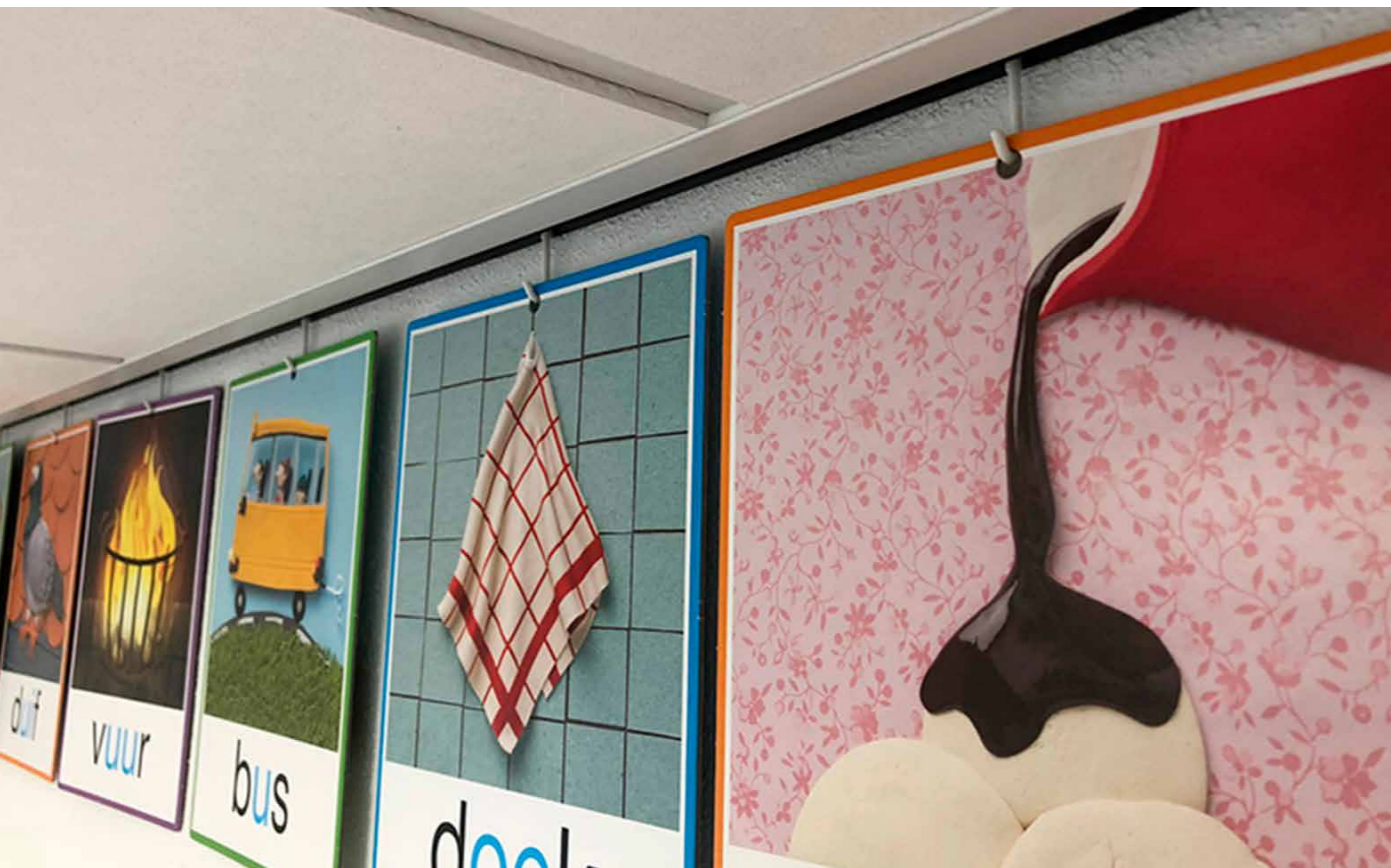

MISCELLANEOUS

LOOP MAKER



COMPATIBLE WITH ALL PERLON WIRES 2 mm, SEE PAGE 59

The Loop Maker offers a solution for hanging objects if a hook cannot be used. As it is possible to create a loop with the 2-mm perlon hanging wire, it is possible to hang much more than just a picture frame!



MISCELLANEOUS

PICTURE MOUSE



	PICTURE MOUSE WHITE	PICTURE MOUSE STEEL
	150 cm	150 cm
ARTICLE NO.	7805.014	7805.016
COMPATIBLE WITH ALL ARTITEQ PICTURE HANGING SYSTEMS		

Picture Mouse is a handy and original hanging cord for displaying several documents, such as cards and photos. It can also be used as a 'solo' version rather than as part of a picture hanging system. The Picture Mouse Solo system is simple to install by mounting the wall clip to the wall. The steel Picture Mouse cord can be inserted and is hung from the wall clip.

PICTURE MOUSE SOLO (COMPLETE SET)

PICTURE MOUSE SOLO	PICTURE MOUSE WHITE	WALL CLIP + COVER (WITH FASTENER MATERIAL)	PICTURE CLIP TRANSPARENT
	1x	1x	10x
	150 cm		
ARTICLE NO.	7840.100		

As well as the transparent clips, magnets can also be used on the Picture Mouse cord. The Mouse Magnets, available in white or in colour, combine perfectly with the Picture Mouse cord.

PICTURE CLIP TRANSPARENT	MOUSE MAGNETS WHITE	MOUSE MAGNETS COLOUR	
ARTICLE NO.	7805.007	7430.020	7430.010



▶ FRAME ACCESSORIES



SIMPLE
SAFE
STRONG

▶ ARTITEQ BACK FRAME HANGING SYSTEM



The Artiteq Back Frame Hanging System is a mounting system especially for thin and flexible panels made of aluminium, forex or acrylic. It helps to stiffen the panel, whilst mounting remains easy and safe. Using the Back Frame Hanging System also adds depth and shadow between panel and wall. The Artiteq Back Frame Power Corners provide 3 easy ways of hanging a printed panel : Fixed (1), Secured (2) and Flexible (3).

SAFE
SOLID
EASY HANGING



ARTITEQ BACK FRAME HANGING SYSTEM

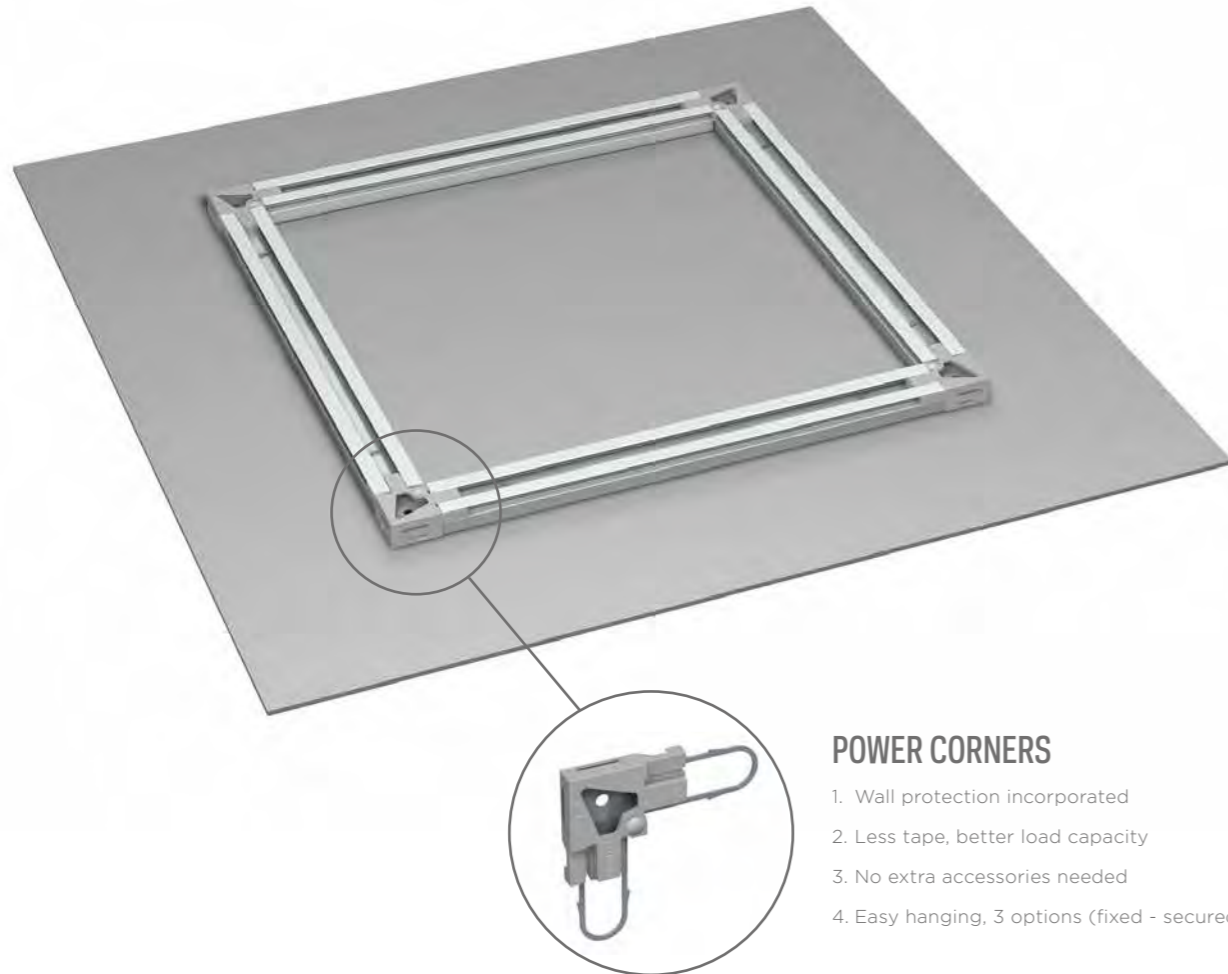

POWER CORNERS

1. Wall protection incorporated
2. Less tape, better load capacity
3. No extra accessories needed
4. Easy hanging, 3 options (fixed - secured - flexible)

ARTITEQ BACK FRAME HANGING SYSTEM

			
BACK FRAME RAIL 8 mm 300 cm ALU MILL FINISH	BACK FRAME RAIL 8 mm 300 cm SILVER ANODISED	BACK FRAME RAIL 15 mm 300 cm ALU MILL FINISH	BACK FRAME RAIL 15 mm 300 cm SILVER ANODISED
05.16300	05.16301	05.17300	05.17301



installation video

					
BACK FRAME POWER CORNER 8 mm (SET OF 4)	BACK FRAME POWER CORNER 15 mm (SET OF 4)	TAPE 3M 12 mm 33 M	BACK FRAME SECURITY CLIP (4 CLIPS, 4 PLUGS, 4 SCREWS)	BACK FRAME SECURITY KEY	BACK FRAME FLEX BUMPER
05.16010	05.17010	05.16050	05.16060	05.16030	05.16040
		3M VHB CLEANING TISSUES 05.16055			

ARTITEQ BACK FRAME HANGING SYSTEM

EASY HANGING

1 FIXED

Power Corners include a levelling system for the mounted panel, enabling accurate hanging without new holes having to be drilled.

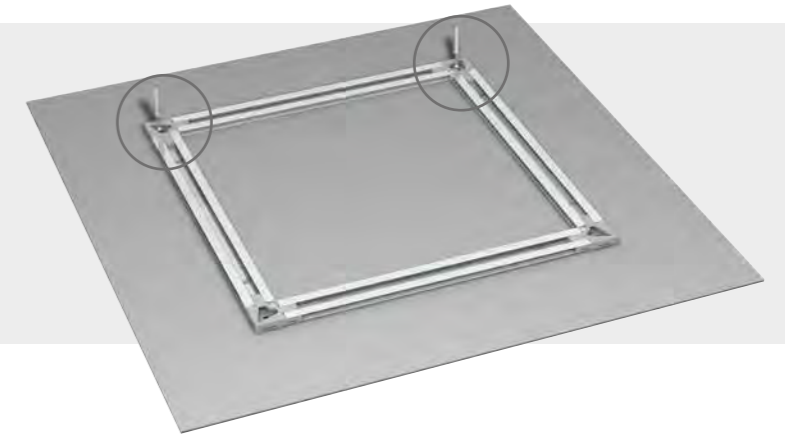

2 SECURED

The panel can be fixed and secured to the wall using 4 Back Frame Security Clips.

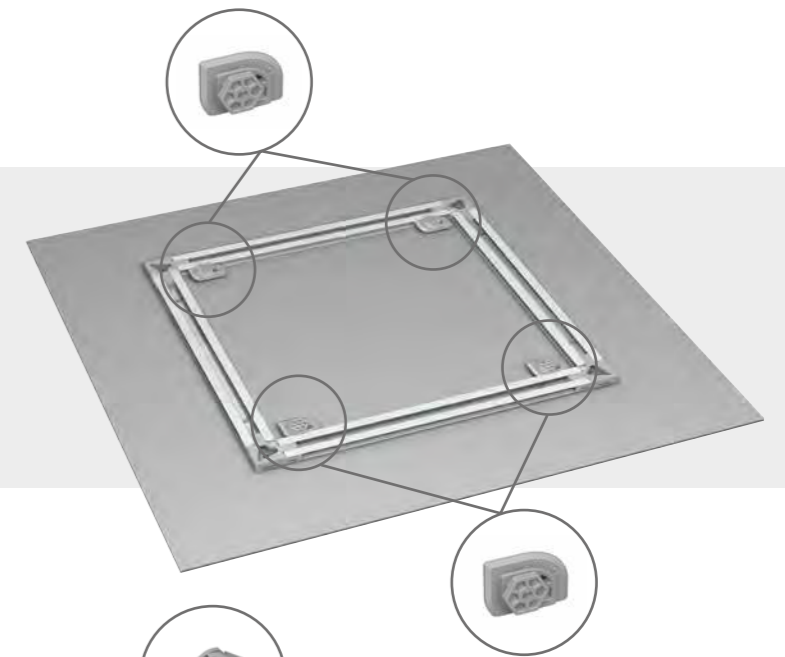

3 FLEXIBLE

Combining the Back Frame Hanging System with a picture hanging system means flexibility and ease-of-use whilst adding decoration to walls.

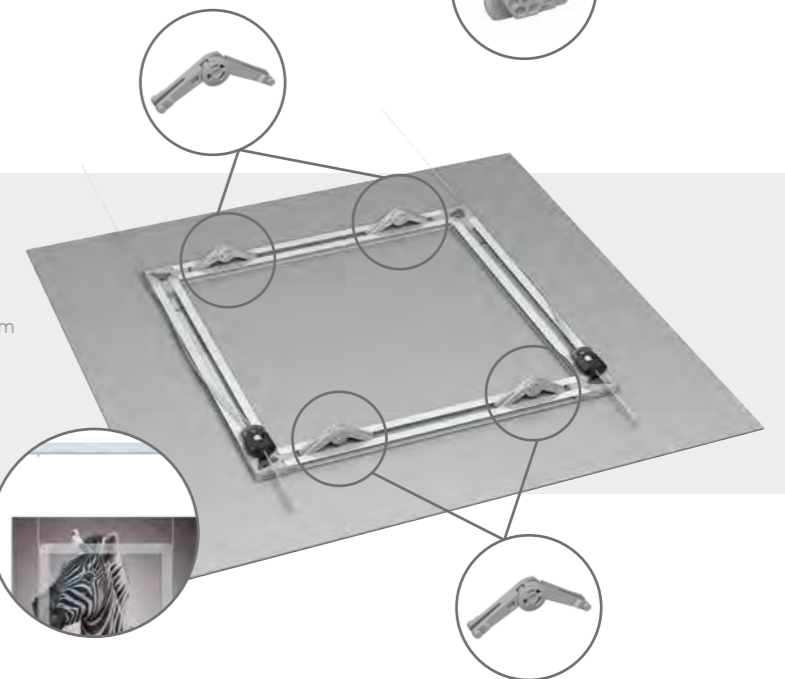

ACCESSORIES FOR FRAMES AND PANELS



D-RING HANGER
SCREW D-RING
HANGING SET STEELWIRE + D-RING HANGERS

ARTICLE NO. 805.249 9.4911 9.5522



FRAME HANGER 1-1,5 mm STEELWIRE (MAX. 10 kg)
FRAME HANGER 1,5-2 mm STEELWIRE (MAX. 15 kg)

ARTICLE NO. 7805.055 7805.050



SET D-RING
SECURITY SET
SET FOLDING EYE
SET CONCRETE HOOKS (4 PIECES)
SET WALL HOOKS

ARTICLE NO. 4055 4054 4057 4058 4059

SPOOL



STEELWIRE 1 mm SPOOL
STEELWIRE 1,2 mm SPOOL
STEELWIRE 1,5 mm SPOOL
PERLON 2 mm SPOOL

ARTICLE NO. 100 m 9.4904 9.4955 9.4990 9.4404
ARTICLE NO. 500 m - - - 9.4421S



PRESSING NIPPLE 1-1,2 mm
WIRE CLAMP 1,5 mm ALU
WIRE CLAMP 2 mm ALU
HANGING NIPPLE

ARTICLE NO. 9.4905 9.4430 9.4431 9.4211

ACCESSORIES FOR FRAMES AND PANELS



DIBOND HANGER

ARTICLE NO. 809.500 ROUND 42 mm (MAX. 0,5 KG)
ARTICLE NO. 809.510 50 X 52 mm (MAX. 1 KG)
ARTICLE NO. 809.520 70 X 70 mm (MAX. 2 KG)
ARTICLE NO. 809.530 100 X 100 mm (MAX. 4 KG)
ARTICLE NO. 809.540 100 X 200 mm (MAX. 8 KG)



SPACERS TRANSPARENT, SELF-ADHESIVE

ARTICLE NO. 809.001 12,5 x 12,5 x 5,7 mm



SPACERS FOAM, SELF-ADHESIVE

ARTICLE NO. 809.002 20 x 20 x 15 mm

MISCELLANEOUS



TILE HANGER 32 mm (MAX. 200 gr)
PLATE HANGER 18-24 cm (MAX. 1 kg)

ARTICLE NO. 808.130 807.025



SET ADHESIVE HANGER 30mm (8 PIECES)
SET TILE HANGER (4 PIECES)
SET FRAMEHOOK + HANGING

ARTICLE NO. 4050 4051 4056



FRAME HANGER FOR USE WITH WOOD
FRAME HANGER FOR USE WITH ALUMINIUM
SET FRAME HANGERS L&R

ARTICLE NO. 808.650 808.720 808.600

▶ DISPLAY HANGING SYSTEMS

CABLE SYSTEMS

MULTIFUNCTIONAL
SAFE
STRONG



IMAGINE IT magazines

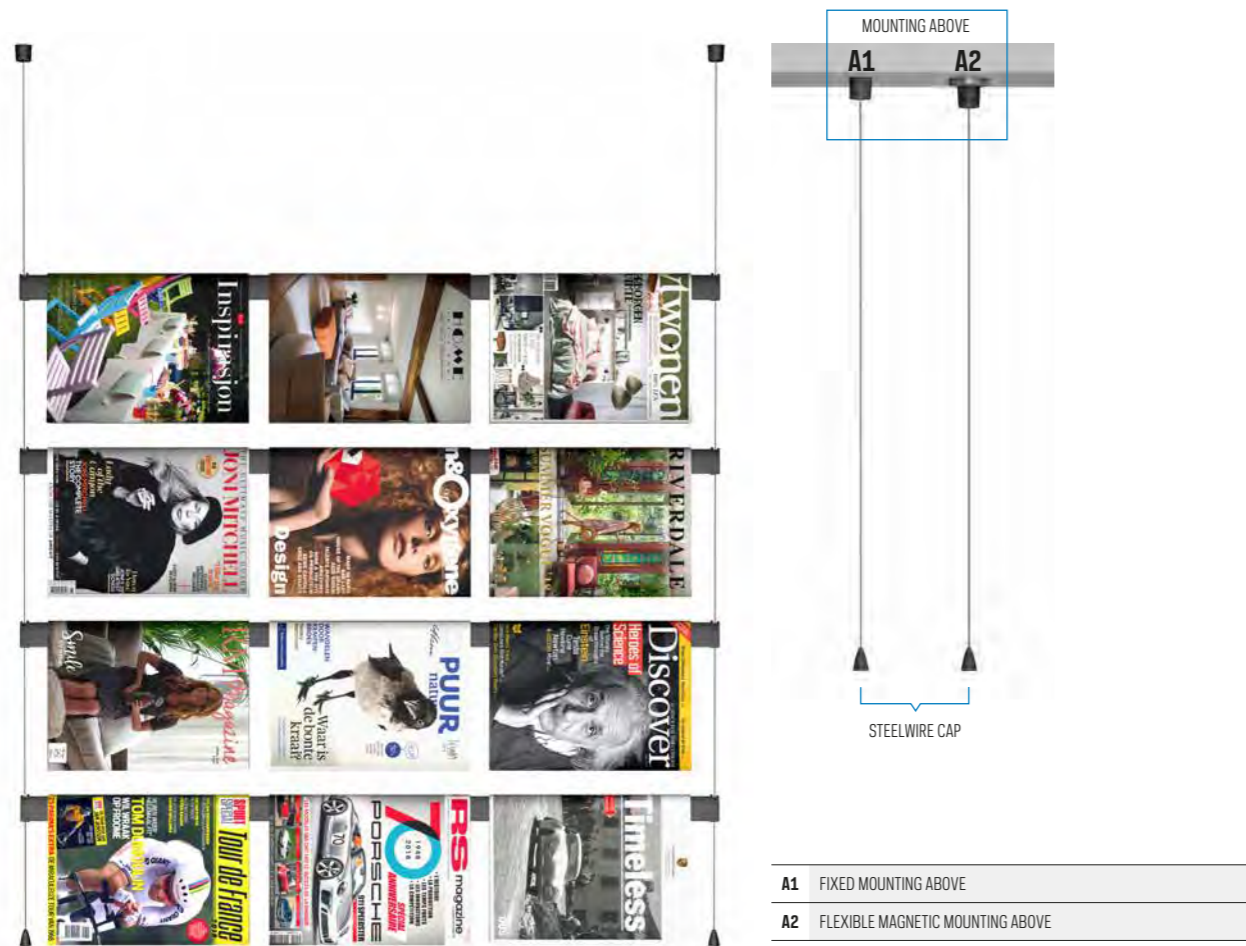

Dynamic hanging system in the workspace

IMAGINE IT magazines is a dynamic hanging system that injects more colour and energy into ordinary workplaces. This new Artiteq concept allows inspirational magazines and trade journals to become part of the office in an appealing way. The great thing about this system is that it is unobtrusive: because of its minimalistic design, IMAGINE IT magazines almost appears to float. As well as being a presentation system, IMAGINE IT magazines is the fastest and most stylish way of dividing a department into different autonomous workstations. This ensures that a pleasant and open atmosphere is preserved, at the same time allowing sufficient privacy to enable individuals to focus on their work.

A narrow cable runs along both sides of the IMAGINE IT magazines hanging system which connects the horizontal rails to one another. Through a special mechanism in the end caps, the height of the various magazine rails can be adjusted. This enables a rail to easily be slid upwards or downwards, thereby immediately creating a different look. The rails are available in a 99 cm, 133 cm and 166 cm design, for 3, 4 or 5 magazines. You can also opt for magnetic suspension against a steel wall.

IMAGINE IT magazines

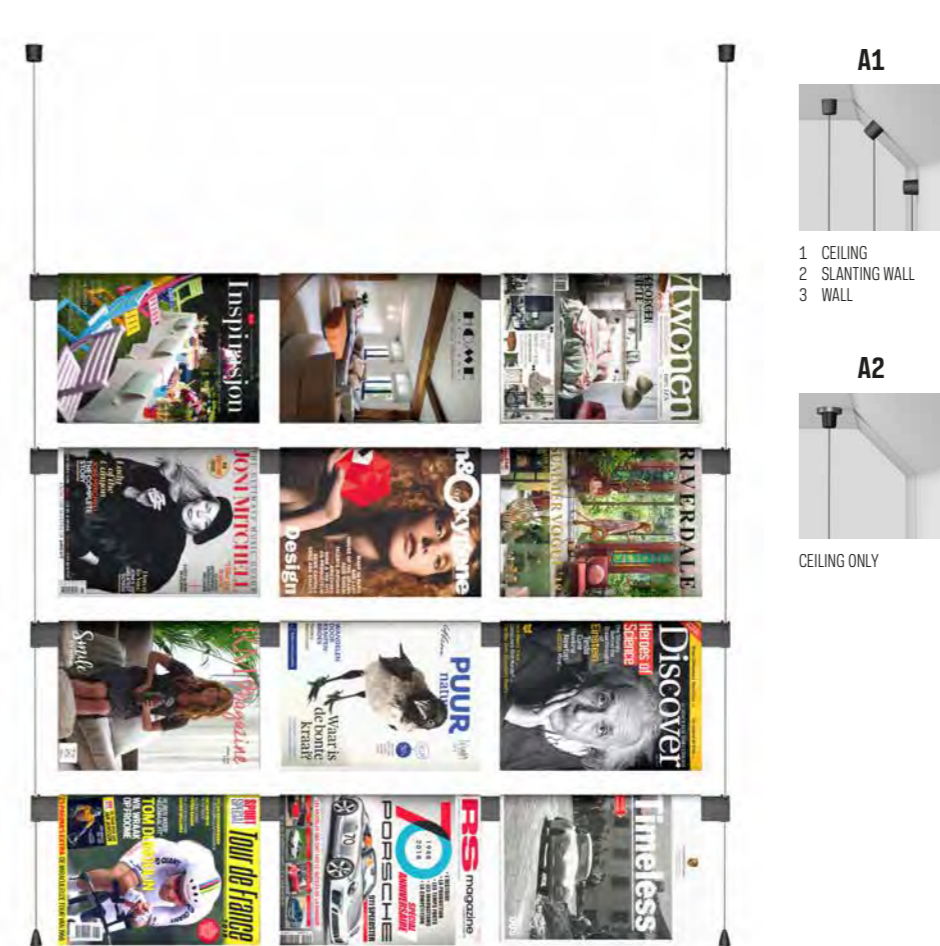

SUITABLE FOR USE IN OPEN SPACES, FOR EXAMPLE AS A ROOM DIVIDER (FIXED MOUNTING ABOVE)



installation video

IMAGINE IT MAGAZINES

	05.10166	IMAGINE IT RAIL BLACK	166 cm
	05.09166	IMAGINE IT RAIL ALU	166 cm
A1	7820.200	IMAGINE IT RAIL INSTALLATION KIT 400 cm	
A2	7820.210	IMAGINE IT RAIL INSTALLATION KIT MAGNETIC 400 cm	

IMAGINE IT smart pockets

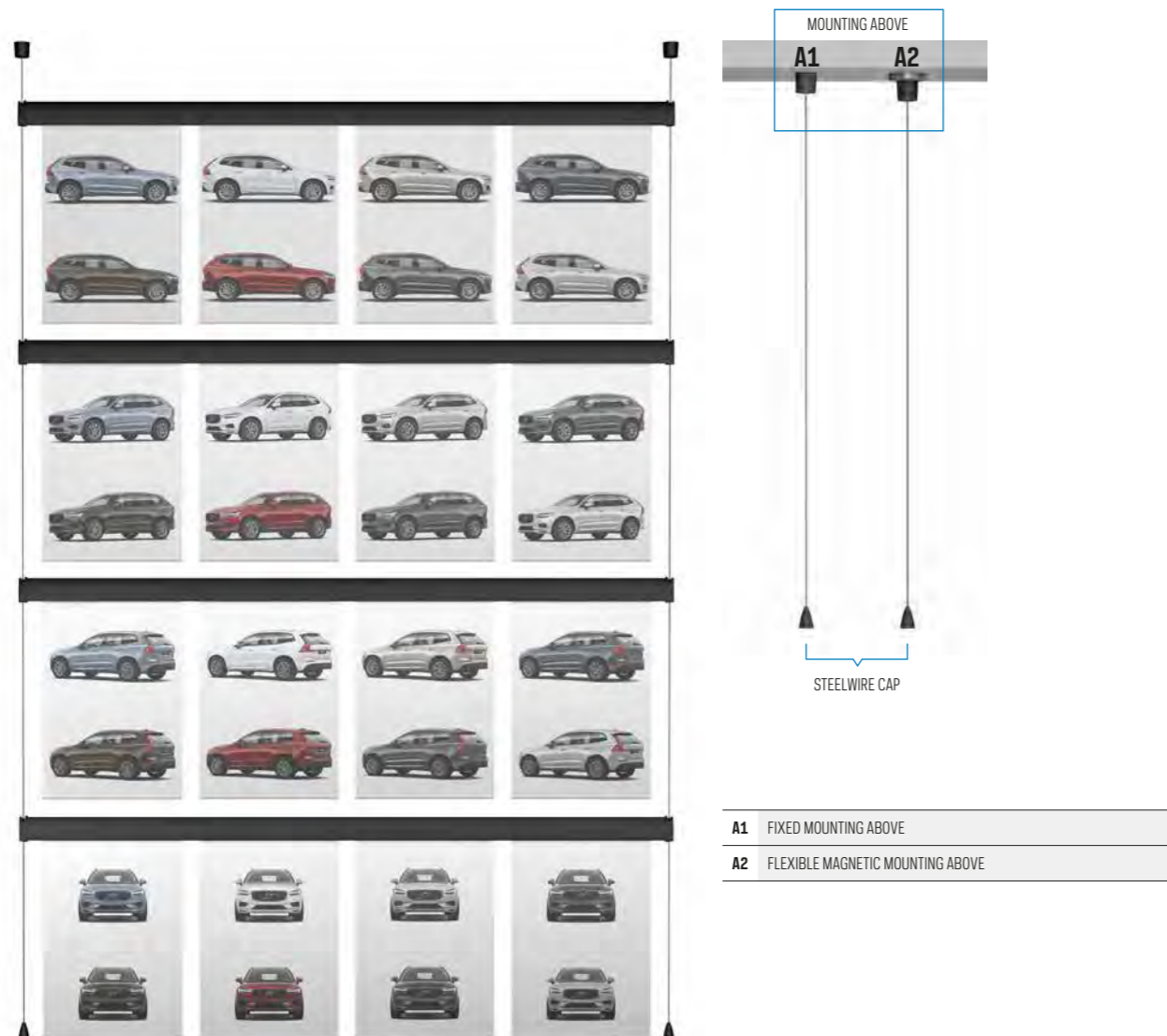

Stylish presentation in a modern workspace

IMAGINE IT Smart Pockets is the most flexible system for presenting ambient images, documents and product photos. Unleash your imagination and vary the layout and size. The double-sided Smart Pockets are available in A3 and A4 versions and the rails are height adjustable, immediately giving a different effect. But better still, the system as a whole looks splendid. Streamlined, uncluttered and modern. As well as the practical considerations, IMAGINE IT Smart Pockets is an extremely aesthetic choice that merges with interior décor and design. The double-sided Smart Pockets can easily be clicked into the rail and they have a subtle notch at the side where you can easily change the content. Opt for an A3 or A4 size, or combine both for a more playful result.

IMAGINE IT smart pockets

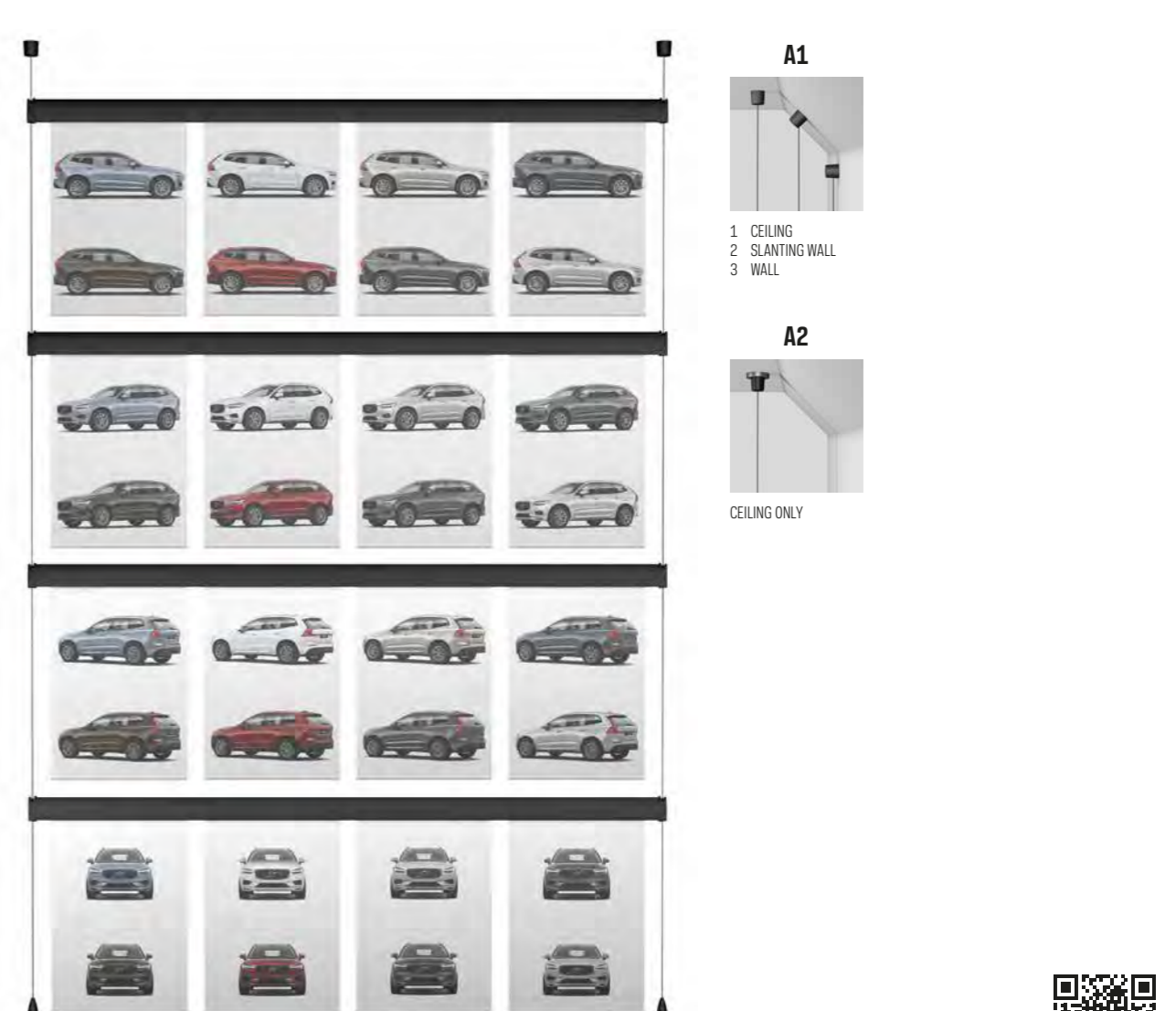

IMAGINE IT SMART POCKETS

	05.10166	IMAGINE IT RAIL BLACK	166 cm
	05.09166	IMAGINE IT RAIL ALU	166 cm
A1	7820.200	IMAGINE IT RAIL INSTALLATION KIT 400 cm	
A2	7820.210	IMAGINE IT RAIL INSTALLATION KIT MAGNETIC 400 cm	

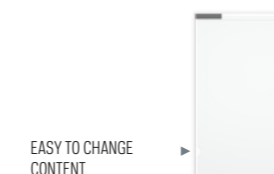

7804.210	SMART POCKET A4	PORTRAIT
7804.310	SMART POCKET A3	PORTRAIT
7804.220	SMART POCKET A4	LANDSCAPE
7804.320	SMART POCKET A3	LANDSCAPE

DISPLAY IT LED FLEX







Make a statement with LED panels

This cable system, with LED lighting, enables documents, products and services to be displayed perfectly. It is ideal as a display system in display cabinets, where the information can stand out both day and night! The rail can be mounted to the wall or the ceiling. The adaptors can be twisted into and out of the rail in an instant, allowing flexible use of the system.

The A3 and A4 LED panels can be used in either horizontal or portrait orientation and have clear LED lighting. The steel cables run through an auto-grip mechanism through the LED panels, connecting these together. This gives a professional, streamlined display and allows the height of the panels to be quickly and easily adjusted. This system allows double-sided displays: translucent paper can be inserted into the front and back of the LED panels.

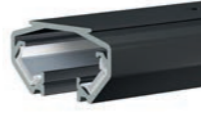
DISPLAY IT LED FLEX

RAIL

				
RAIL BLACK*	HANGING SET	TRANSFORMER		POWER CONNECTOR SET
183 cm	2x200 cm	60 VA	200 VA	
ARTICLE NO. 7720.183	7710.010	7730.060	7730.200	7710.020

*RAIL INCLUDES FASTENER MATERIAL AND END CAPS

LED PANELS



7700.004	A4	9 watt
7700.003	A3	17 watt

PREMIUM NEVERTEAR BACKLIT PAPER

	7706.004	A4
	7706.003	A3



installation video



DISPLAY IT LED FIXED

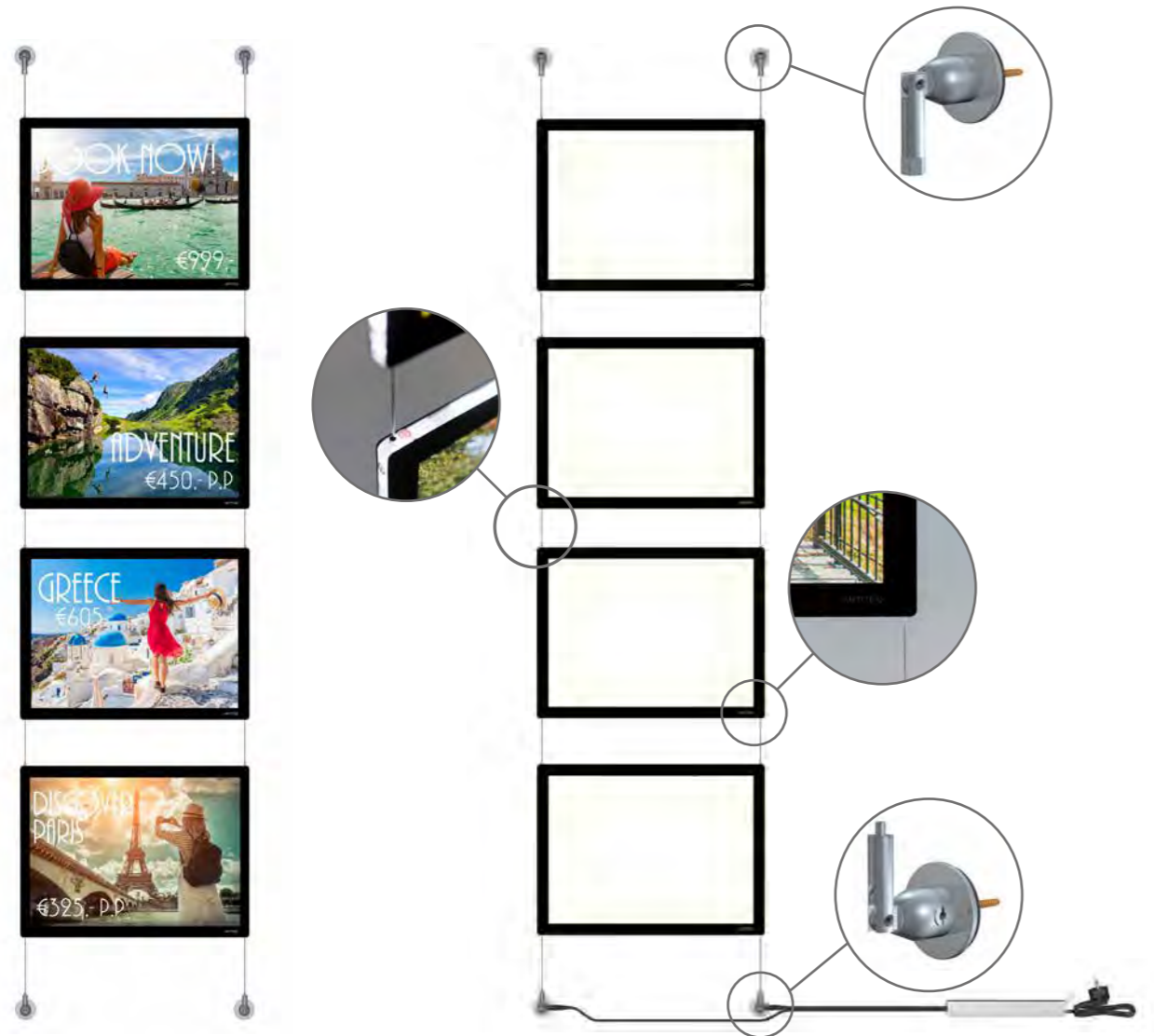

An eye-catcher on the wall

The Display It LED Fixed cable system is mounted to the wall or ceiling and because of the LED panels, this creates a striking display. Like the Flex version, the Display It LED Fixed can be used in display cabinets or in other places in a building. The content of the panels can be changed in no time.

The A3 and A4 LED panels can be used in either horizontal or portrait orientation and have clear LED lighting. The steel cables run through an auto-grip mechanism through the panels, connecting these together. This gives a professional, streamlined display and allows the height of the panels to be quickly and easily adjusted. This system allows double-sided displays: translucent paper can be inserted into the front and back of the LED panels.

DISPLAY IT LED FIXED

SET STEELWIRE



HANGING SET



TRANSFORMER

	2x 300 cm	60 VA	200 VA
ARTICLE NO.	7710.030	7730.060	7730.200

LED PANELS

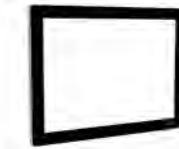

7700.004	A4	9 watt
7700.003	A3	17 watt

PREMIUM NEVERTEAR BACKLIT PAPER



7706.004	A4
7706.003	A3

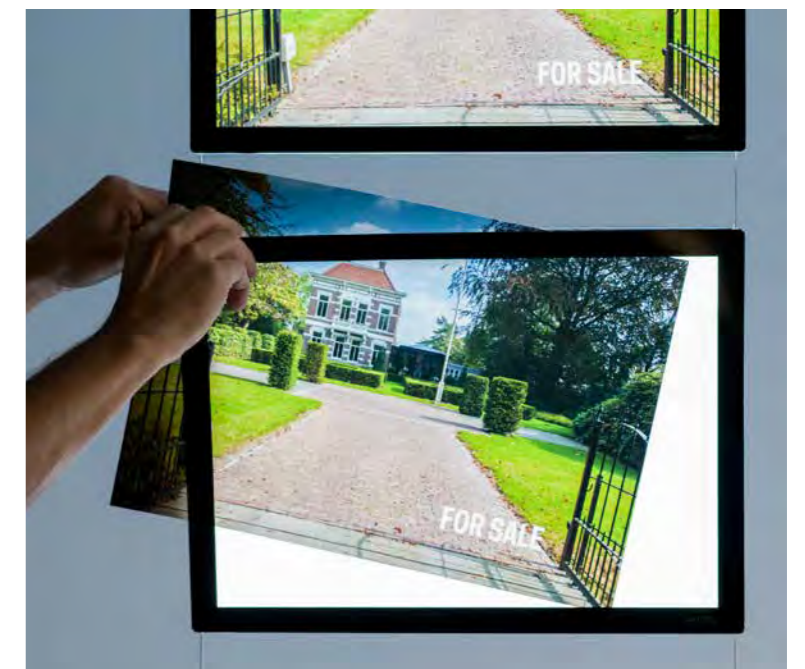

DISPLAY IT FIXED



Display It: professional and orderly

The Display It presentation system gives you a professional and orderly way to display your announcements or documents. The system's acrylic frames are easy to mount and adjust to the desired height. Thanks to the E-Clip for Display It, you can change the contents of the acrylic frames in seconds. The clip also makes it easy to connect the frames to one another, making both horizontal and vertical displays possible. This display system is ideal for estate agents and is often used as a 'face wall' for photos of staff displayed on the wall in hospitals and other institutions. Display It is available in Flex and Fixed mounting models. The Display It Flex version is used in combination with a hanging rail and stainless steel rods that are easy to reposition along the rail.

DISPLAY IT FIXED

SET STEELWIRE

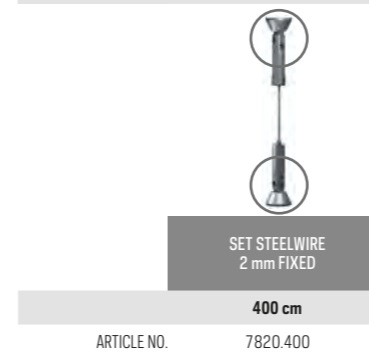

SET STEELWIRE
2 mm FIXED

400 cm

ARTICLE NO. 7820.400

CLAMPS



E-CLIP

2 mm

ARTICLE NO. 7805.005

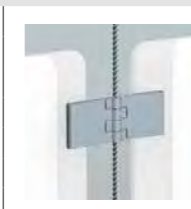

CLAMP

2-4 mm

ARTICLE NO. 7805.001

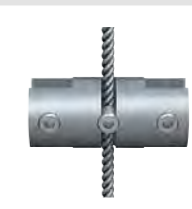

DOUBLE CLAMP

2-4 mm

ARTICLE NO. 7805.002

DISPLAYS



ARTICLE NO.	7803.211	2 mm A4	30 x 21 cm LANDSCAPE
ARTICLE NO.	7803.212	2 mm A4	21 x 30 cm PORTRAIT
ARTICLE NO.	7803.301	2 mm A3	42 x 30 cm LANDSCAPE
ARTICLE NO.	7803.302	2 mm A3	30 x 42 cm PORTRAIT



CLAMP DISPLAY

ARTICLE NO. 7805.003

ALL-IN SET



BOX DISPLAY IT E-CLIP

2 x set steelwire 2 mm fixed (400 cm), 20 x E-Clip, 5 x display 2 mm A4 portrait

ARTICLE NO. 7830.401



installation video

EASY TO CHANGE CONTENT

DISPLAY IT FLEX



Display It: professional and orderly

The Display It presentation system gives you a professional and orderly way to display your announcements or documents. The system's acrylic frames are easy to mount and adjust to the desired height. Thanks to the E-Clip for Display It, you can change the contents of the acrylic frames in seconds. The clip also makes it easy to connect the frames to one another, making both horizontal and vertical displays possible. This display system is ideal for estate agents and is often used as a 'face wall' for photos of staff displayed on the wall in hospitals and other institutions. Display It is available in Flex and Fixed mounting models. The Display It Flex version is used in combination with a hanging rail and stainless steel rods that are easy to reposition along the rail.

DISPLAY IT FLEX

CAN BE USED WITH ALL ARTITEQ PICTURE HANGING SYSTEMS



EASY TO CHANGE CONTENT

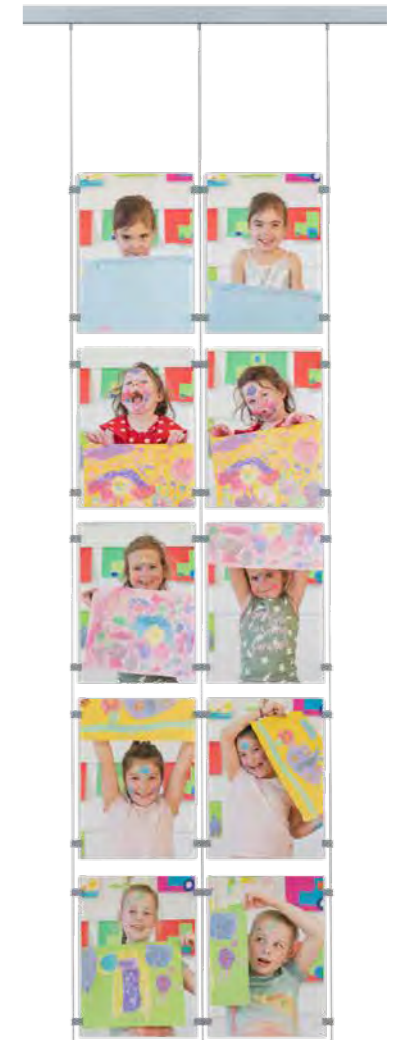

RODS

	TWISTER 2 mm ROD STAINLESS STEEL	TWISTER 2 mm ROD WHITE
	200 cm	200 cm
ARTICLE NO.	9.4188	9.4198

CLAMPS

	E-CLIP	CLAMP	DOUBLE CLAMP
	2 mm	2-4 mm	2-4 mm
ARTICLE NO.	7805.005	7805.001	7805.002



installation video

DISPLAYS

	ARTICLE NO.	7803.211	2 mm A4	30 x 21 cm LANDSCAPE
	ARTICLE NO.	7803.212	2 mm A4	21 x 30 cm PORTRAIT
	ARTICLE NO.	7803.301	2 mm A3	42 x 30 cm LANDSCAPE
	ARTICLE NO.	7803.302	2 mm A3	30 x 42 cm PORTRAIT



CLAMP DISPLAY
7805.003



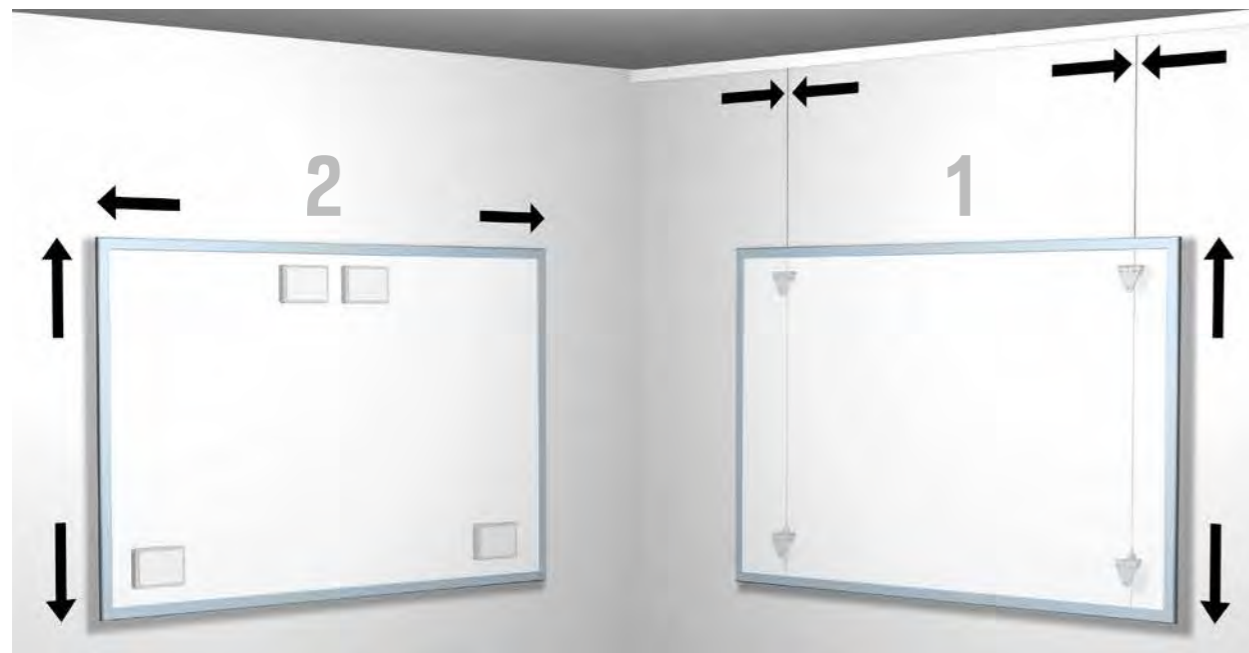

HANGING WHITEBOARDS



There are a variety of ways to hang a whiteboard on the wall. Hanging a whiteboard with the aid of the Whiteboardset offers the option of repositioning the whiteboard either horizontally or vertically. The Artiteq Whiteboardset has been designed to make it easy to hang a whiteboard on the wall, and offers flexibility since it may be used in combination with our hanging rails. The clamps ensure a stable mounting of the whiteboard to the wall. By combining the Whiteboardset with the hanging rail, it is extremely easy to mount the whiteboard to the precise desired spot.

WHITEBOARDSET / HANGING MAGNET FOR WHITEBOARDS



WHITEBOARDSET				
	 2x	 2x	 12x	 12x
WHITEBOARDSET (HANGING WIRE NOT INCLUDED)*	KLEM UP	KLEM DOWN	SCHROEF 8 mm	SCHROEF 12 mm
ARTICLE NO. 9.4550				

* TO BE USED WITH TWISTER 2 mm STEELWIRE (SEE PAGE 59)

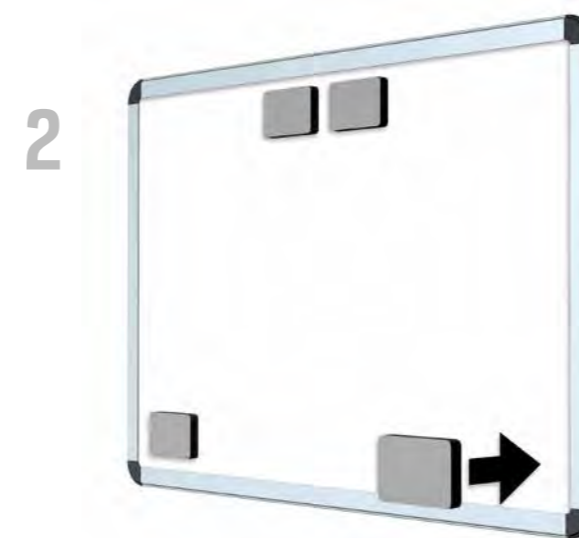

SELF-ADHESIVE HANGING MAGNET FOR WHITEBOARDS
7430.001 SELF-ADHESIVE HANGING MAGNET FOR WHITEBOARDS 75 x 50 x 11 mm MAX. 3 kg

▶ DISPLAY HANGING SYSTEMS





RAIL SYSTEMS



FLEXIBLE
MULTIFUNCTIONAL
EASE-OF-USE

INFO RAIL



INFO RAIL				
	05.55025	INFO RAIL WHITE	25 cm	INCLUDES FASTENER MATERIAL AND END CAPS
	05.55050	INFO RAIL WHITE	50 cm	INCLUDES FASTENER MATERIAL AND END CAPS
	05.55100	INFO RAIL WHITE	100 cm	INCLUDES FASTENER MATERIAL AND END CAPS
	05.55200	INFO RAIL WHITE	200 cm	INCLUDES FASTENER MATERIAL AND END CAPS
	05.55300	INFO RAIL WHITE	300 cm	INCLUDES FASTENER MATERIAL AND END CAPS
	05.54025	INFO RAIL ALU	25 cm	INCLUDES FASTENER MATERIAL AND END CAPS
	05.54050	INFO RAIL ALU	50 cm	INCLUDES FASTENER MATERIAL AND END CAPS
	05.54100	INFO RAIL ALU	100 cm	INCLUDES FASTENER MATERIAL AND END CAPS
	05.54200	INFO RAIL ALU	200 cm	INCLUDES FASTENER MATERIAL AND END CAPS
	05.54300	INFO RAIL ALU	300 cm	INCLUDES FASTENER MATERIAL AND END CAPS
	05.56025	INFO RAIL BLACK STRUCTURE	25 cm	INCLUDES FASTENER MATERIAL AND END CAPS
	05.56100	INFO RAIL BLACK STRUCTURE	100 cm	INCLUDES FASTENER MATERIAL AND END CAPS
	05.56200	INFO RAIL BLACK STRUCTURE	200 cm	INCLUDES FASTENER MATERIAL AND END CAPS
	05.47160	END CAP INFO RAIL WHITE (L&R)		
	05.47150	END CAP INFO RAIL ALU (L&R)		
	05.47170	END CAP INFO RAIL BLACK (L&R)		

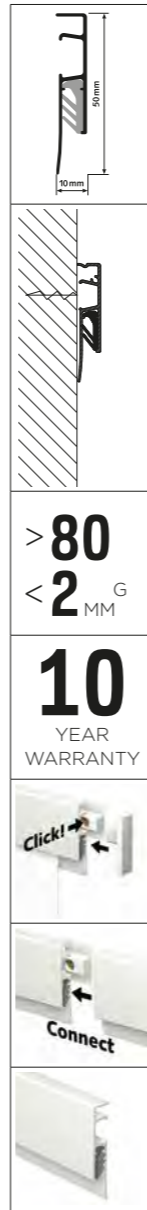

> 80
< 2^G
MM

10
YEAR
WARRANTY



installation video

The Info Rail is the ideal display system for displaying cards, posters, drawings and photos on the wall. Thanks to the Info Rail, you can create a tidy, orderly display of your documents. This system means no more damaged walls from thumbtacks, tape and so on, and changing drawings or posters is fast and easy. This hanging system has become particularly indispensable in classrooms and school corridors. The Info Rail is also an ideal system for displaying or sharing information at home and the office.

Easy assembly thanks to clips

The Info Rail has been developed for hanging documents using a triple rubber clamping mechanism in the rail. Paper from 80 g to cardboard 2 mm thick can be firmly clamped into the rail. After mounting the Click & Connect clips to the wall, it's easy to attach the Info Rail to the clips. Available in different lengths, the Info Rail is easy to link to other Info Rails or shortened. Whether you want to display photos or drawings or keep recipes within easy reach, the Info Rail offers the solution.



FLEXIBLE
DESIGN
HIGH-END

DISPLAY HANGING SYSTEMS - RAIL SYSTEMS

INFO RAIL CLIP HANGER



05.47200

CLIP HANGER

59 x 8,5 x 23 mm



DISPLAY HANGING SYSTEMS - RAIL SYSTEMS

INFO RAIL *me*-CLIP



05.47100

me-CLIP

44,5 x 74 x 13 mm

DISPLAY HANGING SYSTEMS - RAIL SYSTEMS

INFO RAIL *me*



INFO RAIL *me* ALL-IN SET



05.53100

INFO RAIL *me* WHITE

100 cm

includes 4 x *me*-clip

INCLUDES FASTENER MATERIAL AND END CAPS

05.53200

INFO RAIL *me* WHITE

200 cm

includes 4 x *me*-clip

INCLUDES FASTENER MATERIAL AND END CAPS



installation video

Info Rail *me* - personal and organised

The *me*-clip adds an extra personal and beautifully designed element to the Info Rail system. A name can be added to the contents of the clip. A great solution for the perfect presentation and communication tool. The clip is always adaptable and always keeps its 100% quality appearance, no matter how often the clip is used. It's handy, and directly and rapidly adaptable thanks to Info Rail's smart, flexible properties.

Clip Hanger voor Info Rail

With a simple click, the Clip Hanger is attached to the Info Rail, allowing a craft project to be hung up. In combination with the meclip, art creations can be presented in a fun and personal manner.



FLEXIBLE
MULTIFUNCTIONAL
EASE-OF-USE



CARD RAIL



CARD RAIL

7220.110 **CARD RAIL WHITE (RAL 9016)** 114 cm INCLUDES FASTENER MATERIAL, END CAPS AND 4 MOUSE MAGNETS (WHITE)



EXTRA / OPTIONAL



7430.010 **MOUSE MAGNETS COLOUR**

7430.020 **MOUSE MAGNETS WHITE**



Credits: @littlesmall.nl



Credits: @bjuuz

Practical use of narrow wall spaces



This vertical display system takes up little space and can therefore be used in many places in an office or home. The Card Rail is a hanging system for, for example, cards and photos and this is a useful system for collecting or displaying these. The cards and photos can be slid into both sides of the rail. The Card Rail also has a magnetic strip, which can also be used to display photos, cards, etc. The Mouse Magnets can be used on the front of the Card Rail. This display system can be a practical addition to the wall in especially an office, kitchen or child's bedroom.

The Card Rail has a sleek, white finish, RAL 9016 (can be repainted) and is 114 cm in length. Ideal for use in narrow wall spaces in different areas of the home or office.

MAGAZINE RAIL



MAGAZINE RAIL

	05.14166	MAGAZINE RAIL BLACK	166 cm	INCLUDES FASTENER MATERIAL + END CAPS
	05.13166	MAGAZINE RAIL ALU	166 cm	INCLUDES FASTENER MATERIAL + END CAPS
	05.14010	SERVICE SET (CLIP + END CAPS L&R + SCREWS AND PLUGS)		

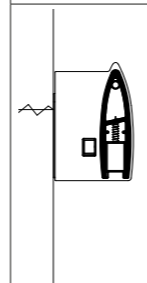
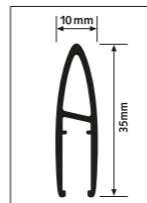

MAX.
5
KG

10
YEAR
WARRANTY



installation video

Attractive presentation: magazines on the wall





Get rid of those messy piles of magazines. Magazine Rail organises periodicals and magazines in a very attractive manner.

Unlike other presentation systems, it all looks orderly and eye-catching. Suitable for a modern interior, decorated with attention to detail and the experience of users. The Magazine Rail has fixed mounting, directly to the wall. Several rails below one another allow several magazines to be presented. The rail is available in 99 cm, 133 cm and 166 cm, for 3, 4 or 5 magazines and in a black or aluminium finish.

SMART POCKET RAIL



SMART POCKET RAIL

	05.61100	SMART POCKET RAIL BLACK	100 cm	INCLUDES FASTENER MATERIAL + END CAPS
	05.61200	SMART POCKET RAIL BLACK	200 cm	INCLUDES FASTENER MATERIAL + END CAPS
	05.60200	SMART POCKET RAIL WHITE PRIMER	200 cm	INCLUDES FASTENER MATERIAL + END CAPS
	7804.210	SMART POCKET A4 (21 X 30 cm)	PORTRAIT	
	7804.310	SMART POCKET A3 (30 X 42 cm)	PORTRAIT	
	7804.220	SMART POCKET A4 (30 X 21 cm)	LANDSCAPE	
	7804.320	SMART POCKET A3 (42 X 30 cm)	LANDSCAPE	

EASY TO CHANGE CONTENT

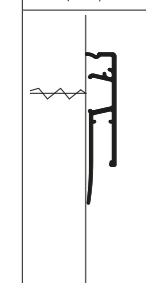
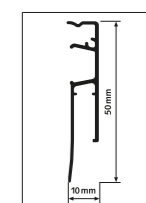

SMART POCKETS A3/A4

10
YEAR
WARRANTY

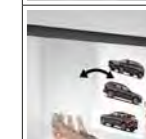

installation video

Stylish presentation of pictures, ideas and information

A speedy solution for improved, more stylish presentation of pictures, ideas and information. From charts and models to photos of employees. The Smart Pocket Rail can be used for a very wide range of applications and is suitable for internal and external use.

It is an ideal system for presenting content in a vivid way. It also transforms a boring wall into a dynamic part of the room.

The Smart Pocket Rail is mounted to the wall with clips. You can easily click the acrylic pockets into this rail. You can choose from an A4 or A3 size. Because of the notch at the back and side of the pocket, you can change the content very quickly and easily, without having to remove the smart pockets from the rail.

CLICK RAIL WITH TWISTER HOOK

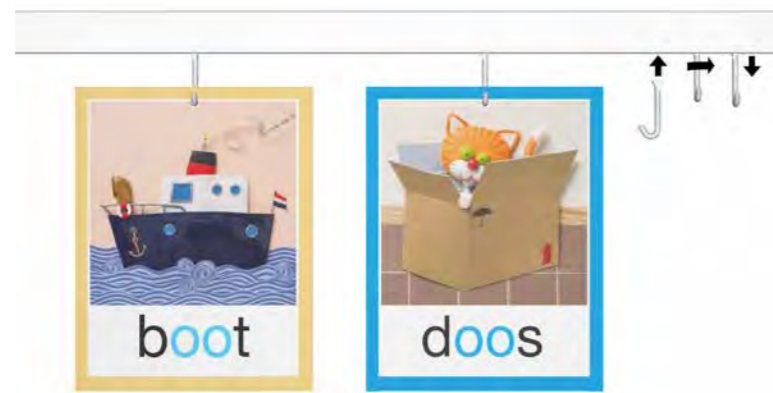

CLICK RAIL WHITE PRIMER (RAL 9016)		TWISTER HOOK
ARTICLE NO. 9.6740.	2 x 200 cm*	50x
*INCLUDES FASTENER MATERIAL		

Twister Hooks, designed by Artiteq, combined with one of the Artiteq hanging rails provide a perfect way of working flexibly with cards or light panels. In classrooms with suspended ceilings, a Top Rail can be attached next to the ceiling. Another option is the Click Rail: a rail that is attached to the wall. The Twister Hook can easily be clicked anywhere on the rail and is simple to move around. The cards will be hanging in a jiffy.

TOP RAIL WITH TWISTER HOOK

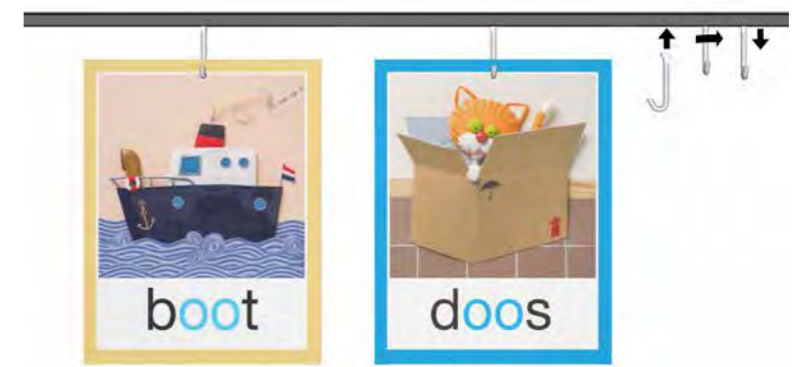
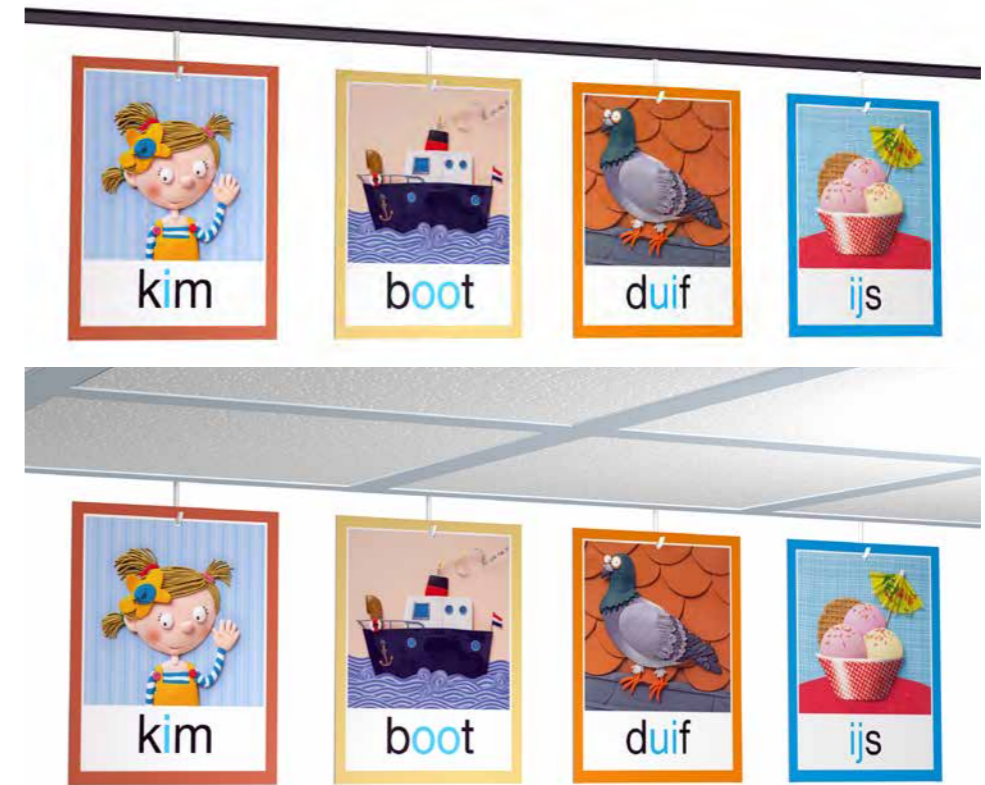

TOP RAIL BLACK		TWISTER HOOK
ARTICLE NO. 9.6741.	2 x 200 cm*	50x
*INCLUDES FASTENER MATERIAL		

► DISPLAY HANGING SYSTEMS

MISCELLANEOUS

FLEXIBLE
HIGH QUALITY
MULTIFUNCTIONAL



CLICK FRAMES AND POSTER SYSTEMS

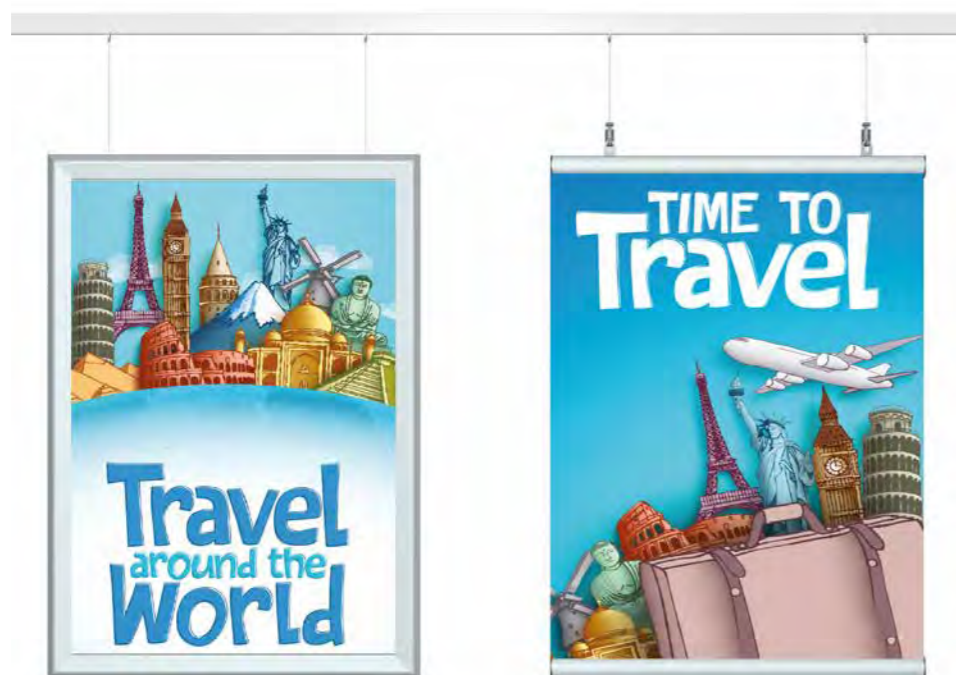

CLICK FRAMES



7020.021 **CLICK FRAME 20 mm A4 21 x 30 cm**

7025.030 **CLICK FRAME 25 mm A3 30 x 42 cm**

7025.042 **CLICK FRAME 25 mm A2 42x 60 cm**

POSTER SYSTEMS

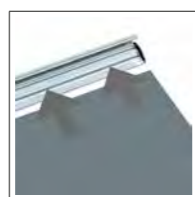

7350.050 **POSTER SNAP 50 cm**

7350.070 **POSTER SNAP 70 cm**

7350.100 **POSTER SNAP 100 cm**

7350.120 **POSTER SNAP 120 cm**

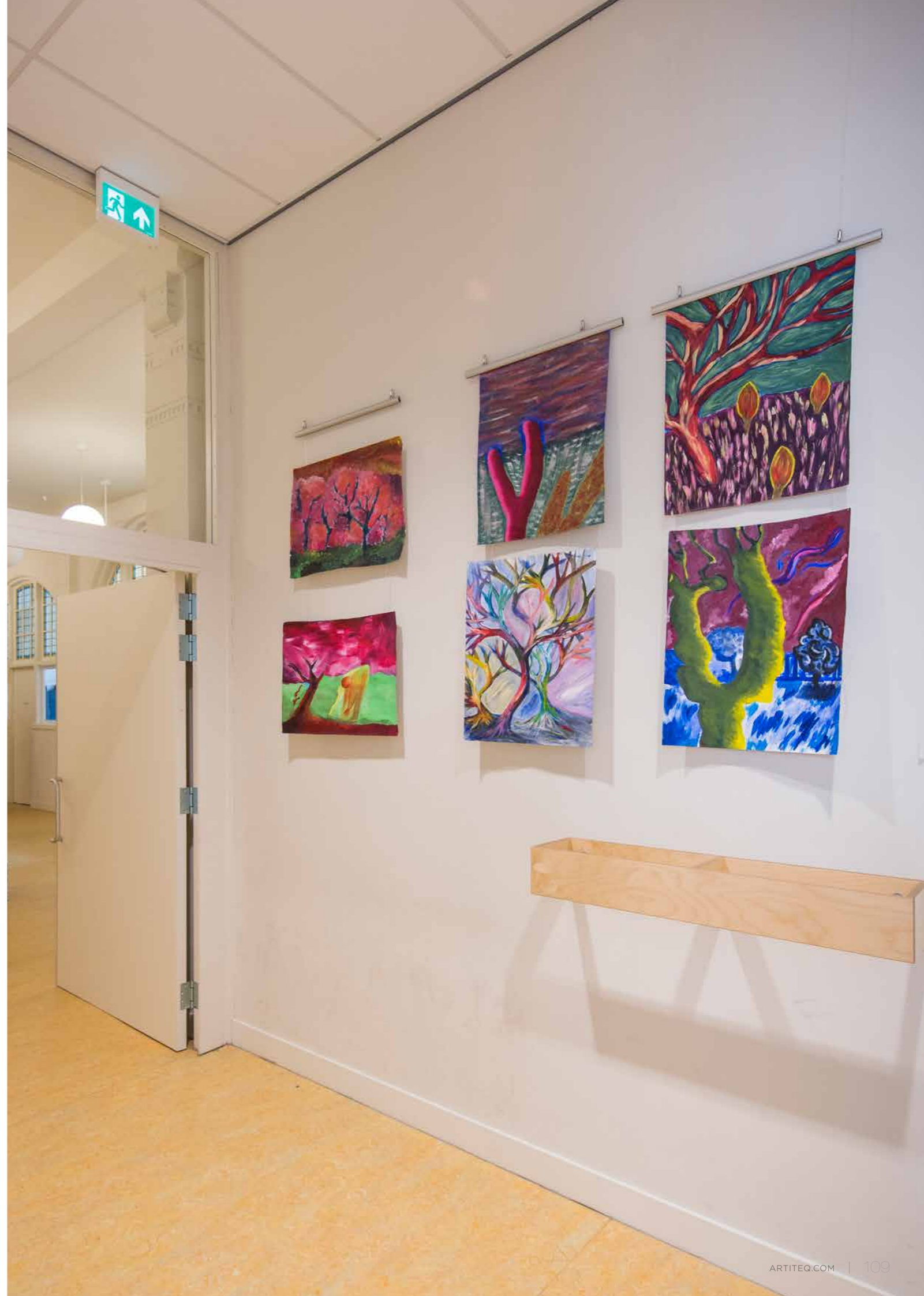

► SIGN HANGING SYSTEMS



PROFESSIONAL
SAFE
FLEXIBLE

XPO RAIL LOW HANGING

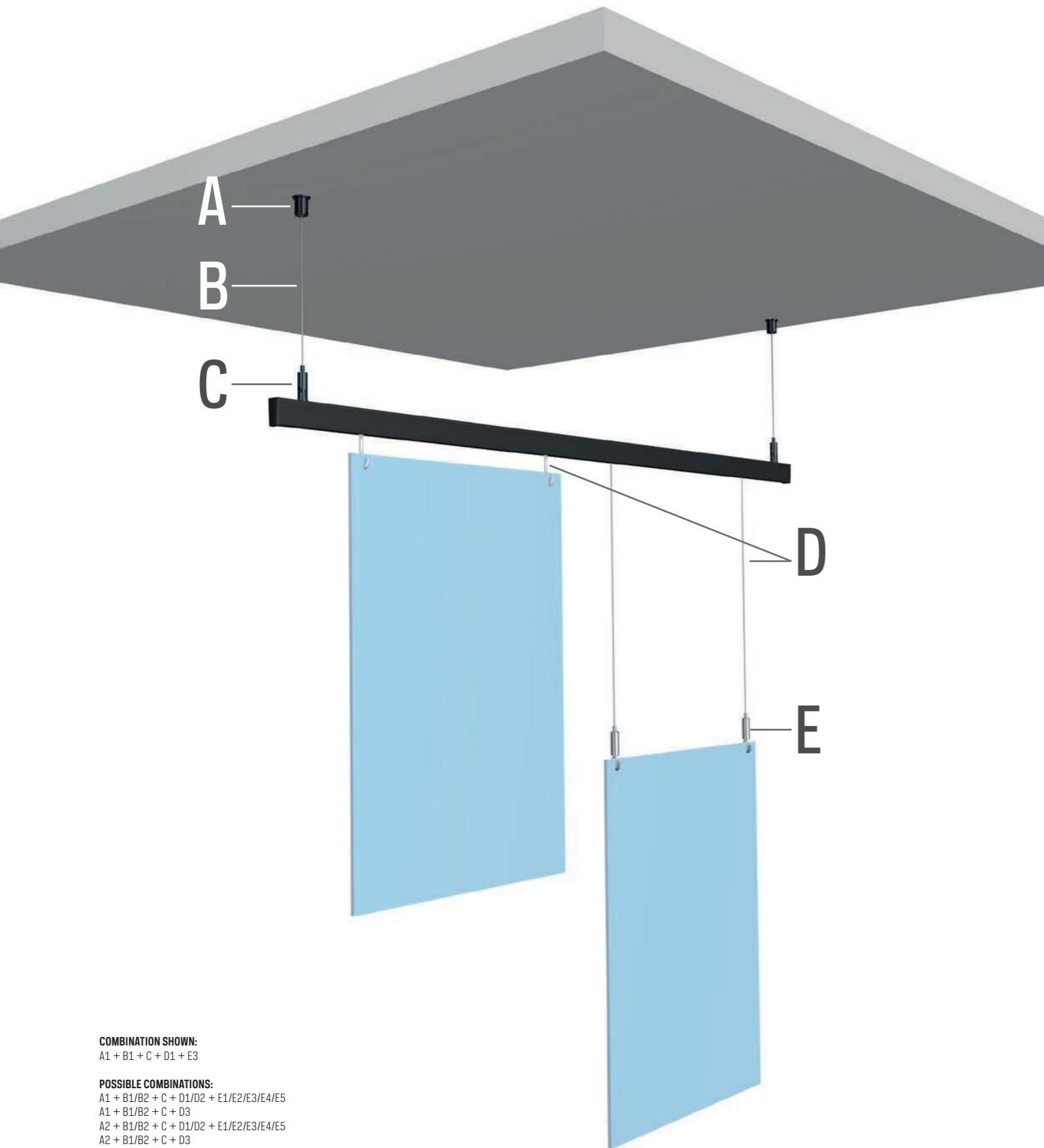

COMBINATION SHOWN:
A1 + B1 + C + D1 + E3

POSSIBLE COMBINATIONS:
A1 + B1/B2 + C + D1/D2 + E1/E2/E3/E4/E5
A1 + B1/B2 + C + D3
A2 + B1/B2 + C + D1/D2 + E1/E2/E3/E4/E5
A2 + B1/B2 + C + D3
A3 + B3 + C + D1/D2 + E1/E2/E3/E4/E5
A3 + B3 + C + D3

XPO RAIL LOW HANGING

A	A1			A2			A3	
	CEILING BRACKET BLACK CO1BL 7807.100	PLUG (Ø 5 mm) 9.4931	SCREW 9.4929	PLAFOND- BEVESTIGING VERNIKKELD CO1NI 7807.110	PLUG (Ø 5 mm) 9.4931	SCREW 9.4929	CEILING SUSPENSION AUTO GRIP 1,2 mm CS01NI 7807.140	
B	B1		B2		B3			
	STEELWIRE + SLIDER 1,2 mm 200 cm BLACK 7807.200		STEELWIRE + SLIDER 1,2 mm 200 cm NICKEL 7807.210		STEELWIRE 7 X 7 1,2 mm 10 M 7807.350		CABLE CUTTER 7807.900	
C	C							
	SUSPENSION BRACKET XPO RAIL 1,2 mm 7807.060	XPO RAIL 200 cm BLACK 05.15201	END CAP XPO RAIL BLACK 05.15030					
D	D1		D2		D3			
	STEELWIRE + SLIDER 1,2 mm 200 cm BLACK 7807.200		STEELWIRE + SLIDER 1,2 mm 200 cm NICKEL 7807.210		TWISTER HOOK 9.4510			
E	E1	E2	E3	E4	E5			
	STEELWIRE HOOK AUTO GRIP 1,2 mm ST01BL 7807.010	STEELWIRE HOOK AUTO GRIP 1,2 mm ST01NI 7807.020	STEELWIRE HOOK AUTO GRIP 1,2 mm ST02NI 7807.030	STEELWIRE HOOK AUTO GRIP 1,2 mm ST03NI 7807.040	STEELWIRE CLAMPHOOK AUTO GRIP 1,2 mm STC01NI 7807.050			

XPO RAIL

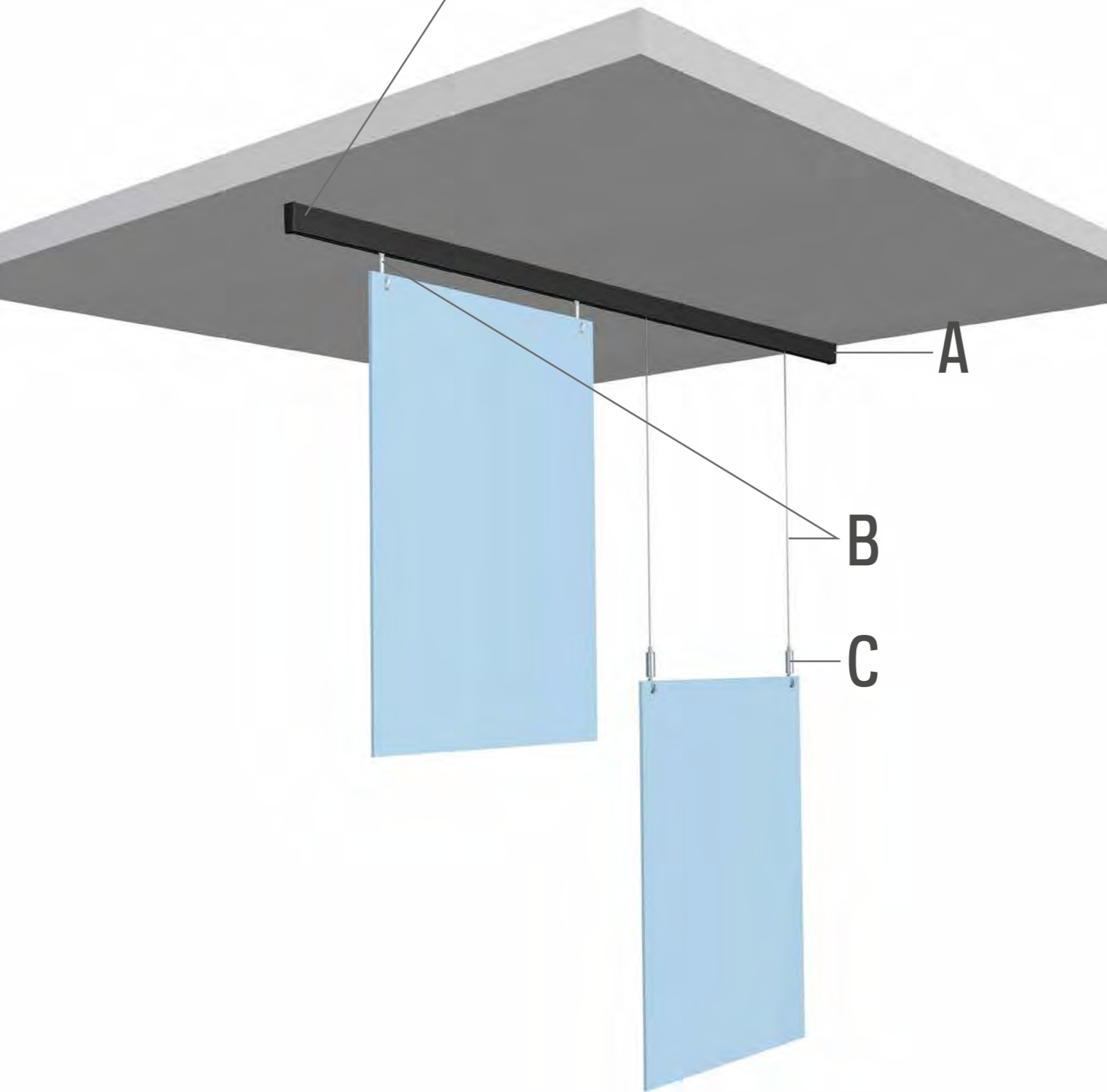

COMBINATION SHOWN:
A + B3
A + B1 + C3

POSSIBLE COMBINATIONS:
A + B1/B2 + C1/C2/C3/C4/C5
A + B3

XPO RAIL

A						
				20 KG/M		
XPO RAIL 200 cm BLACK	XPO RAIL 200 cm WHITE PRIMER	XPO RAIL 200 cm ALU BRUSHED				
05.15201	05.15200	05.15202				

A						
END CAP XPO RAIL BLACK	END CAP XPO RAIL WHITE	CLIP CLICK&CONNECT XPO RAIL	PLUG (Ø 5 mm)	SCREW	FASTENER KIT XPO RAIL WHITE 200 CM	FASTENER KIT XPO RAIL BLACK/ALU 200 CM
05.15030	05.15020	05.15010	9.4929	9.4931	5092	5093

B1		B2		B3	
STEELWIRE + SLIDER 1,2 mm 200 cm BLACK	STEELWIRE + SLIDER 1,2 mm 200 cm NICKEL	TWISTER HOOK			
7807.200	7807.210	9.4510			

C				
C1	C2	C3	C4	C5
STEELWIRE HOOK AUTO GRIP 1,2 mm ST01BL	STEELWIRE HOOK AUTO GRIP 1,2 mm ST01NI	STEELWIRE HOOK AUTO GRIP 1,2 mm ST02NI	STEELWIRE HOOK AUTO GRIP 1,2 mm ST03NI	STEELWIRE CLAMPHOOK AUTO GRIP 1,2 mm STC01NI
7807.010	7807.020	7807.030	7807.040	7807.050

* CONTENT FASTENER KIT

		AANTAL 200 cm	
	05.15010	CLIP XPO RAIL	6x
	9.4931	PLUG FISCHER 5 mm	6x
	9.4929	SCREW FOR PLUG FISCHER 5 mm	6x
	05.15020 / 05.15030	END CAP XPO RAIL WHITE / BLACK	2x
	2639	INSTRUCTION	1x



installation video

CEILING

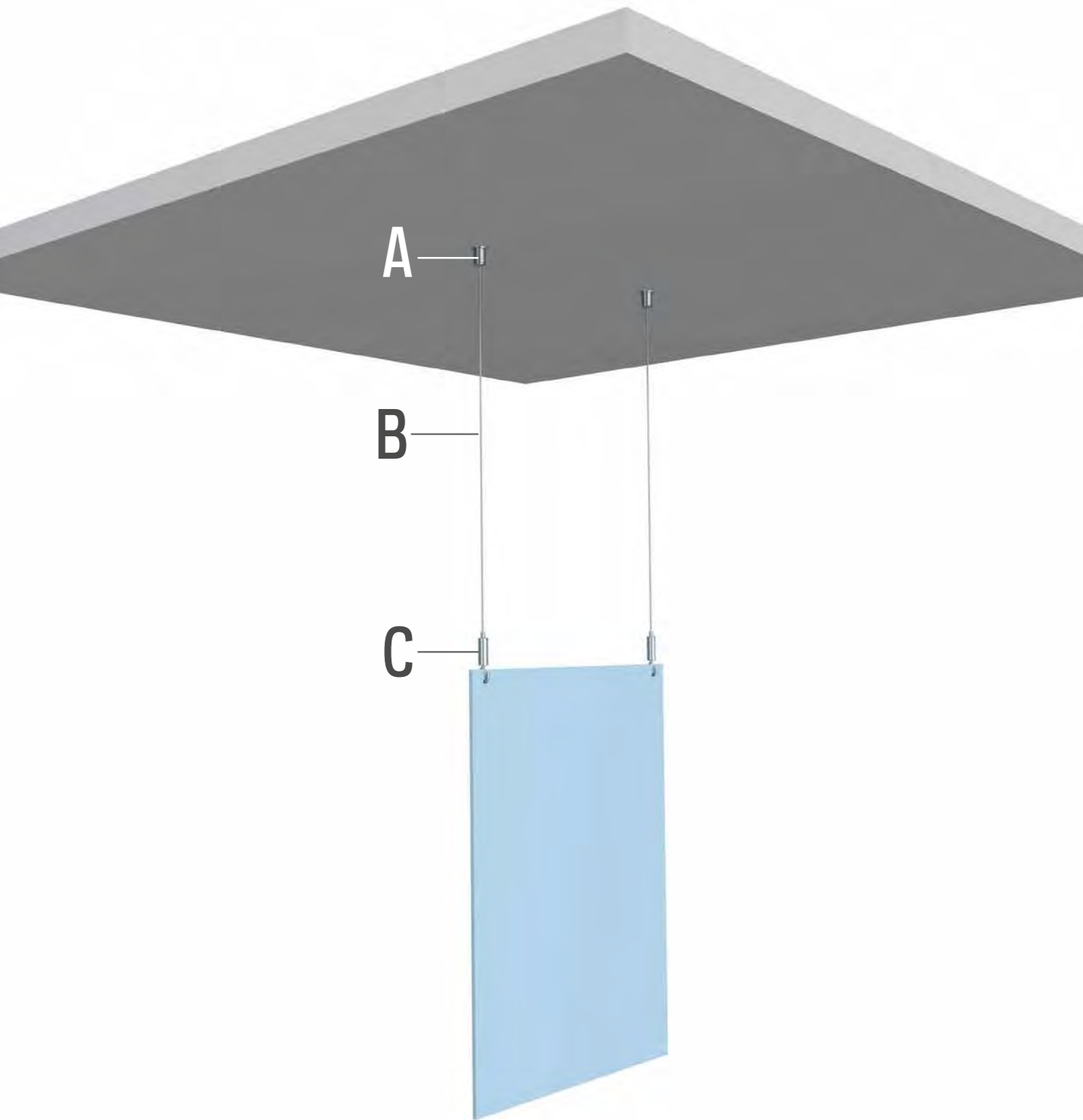

COMBINATION SHOWN:
A2 + B2 + C3

POSSIBLE COMBINATIONS:
A1/A2 + B1/B2/B3 + C1/C2/C3/C4/C5

CEILING

A1			A2			A3	
CEILING BRACKET BLACK C01BL	PLUG (Ø 5 mm)	SCREW	CEILING BRACKET NICKEL C01NI	PLUG (Ø 5 mm)	SCREW	CEILING SUSPENSION AUTO GRIP 1,2 mm CS01NI	
7807.100	9.4931	9.4929	7807.110	9.4931	9.4929	7807.140	

B1		B2		B3	
STEELWIRE + SLIDER 1,2 mm 200 cm BLACK		STEELWIRE + SLIDER 1,2 mm 200 cm NICKEL		STEELWIRE 7 X 7 1,2 mm 10 M	
7807.200		7807.210		7807.350	

C1	C2	C3	C4	C5
STEELWIRE HOOK AUTO GRIP 1,2 mm ST01BL	STEELWIRE HOOK AUTO GRIP 1,2 mm ST01NI	STEELWIRE HOOK AUTO GRIP 1,2 mm ST02NI	STEELWIRE HOOK AUTO GRIP 1,2 mm ST03NI	STEELWIRE CLAMPHOOK AUTO GRIP 1,2 mm STC01NI
7807.010	7807.020	7807.030	7807.040	7807.050

D COMPLETE SETS	
SET CEILING 2x STEELWIRE 1,2 mm 300 cm + 2x CEILING BRACKET NICKEL + 2x STEELWIRE HOOK	
7807.520	



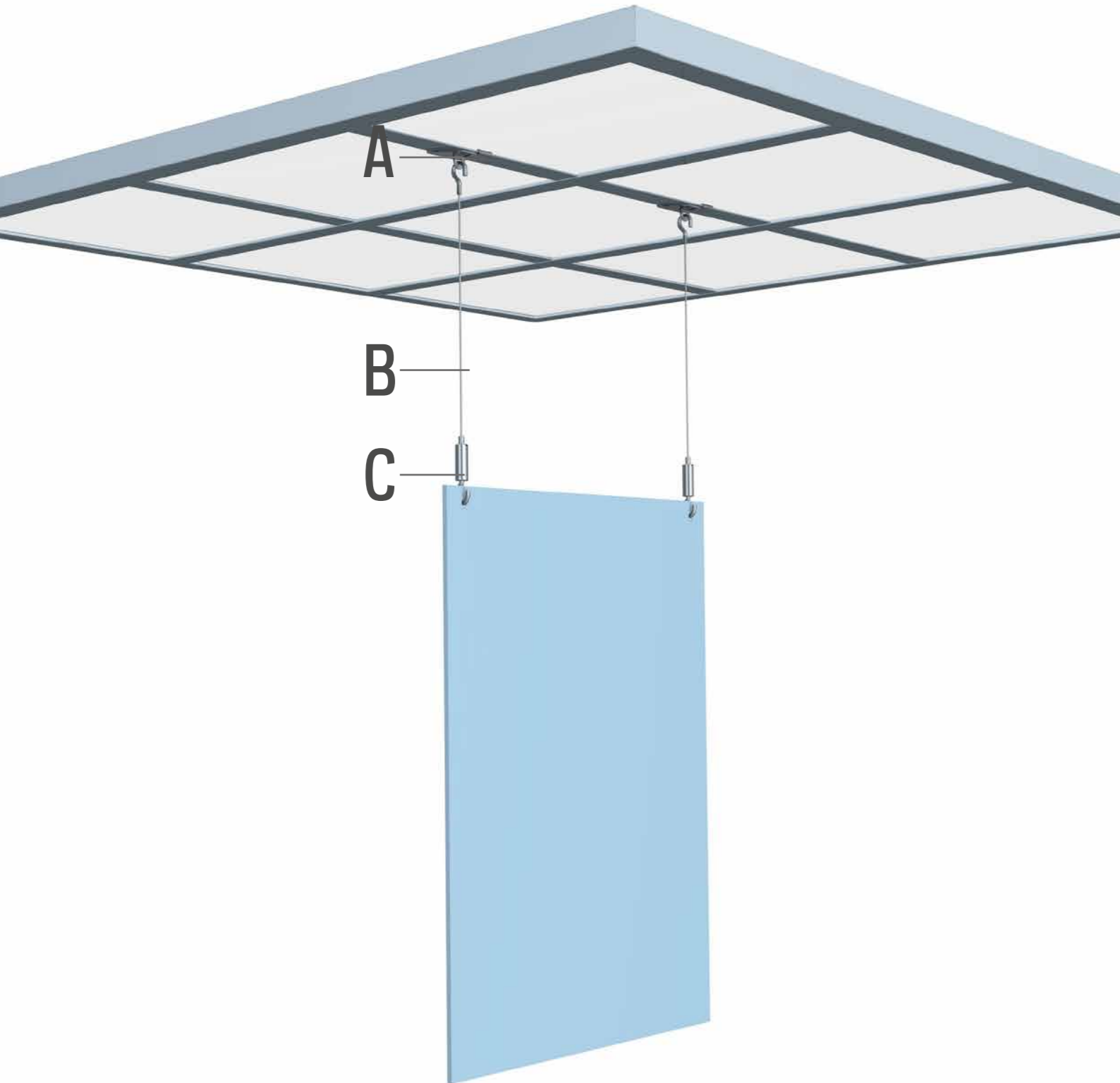







RECESSED CEILING



COMBINATION SHOWN:
A1 + B1 + C3

POSSIBLE COMBINATIONS:
A1 + B1 + C1/C2/C3/C4/C5
A2 + B2 + C1/C2/C3/C4/C5

RECESSED CEILING

A	A1	A2			
					
	RECESSED CEILING CLIP 20 mm	RECESSED CEILING CLIP 20 mm + SUSPENSION AUTO GRIP 1,2 mm			
	7807.120	7807.130			
B	B1	B2			
					
	STEELWIRE + HOOK 1,2 mm 300 cm	STEELWIRE 7 X 7 1,2 mm 10 M	CABLE CUTTER		
	7807.310	7807.350	7807.900		
C	C1	C2	C3	C4	C5
					
	STEELWIRE HOOK AUTO GRIP 1,2 mm ST01BL	STEELWIRE HOOK AUTO GRIP 1,2 mm ST01NI	STEELWIRE HOOK AUTO GRIP 1,2 mm ST02NI	STEELWIRE HOOK AUTO GRIP 1,2 mm ST03NI	STEELWIRE CLAMPHOOK AUTO GRIP 1,2 mm STC01NI
	7807.010	7807.020	7807.030	7807.040	7807.050
	D COMPLETE SETS				
					
SET RECESSED CEILING 2x STEELWIRE 1,2 mm 300 cm + 2x RECESSED CEILING CLIP + 2x STEELWIRE HOOK					
7807.510					



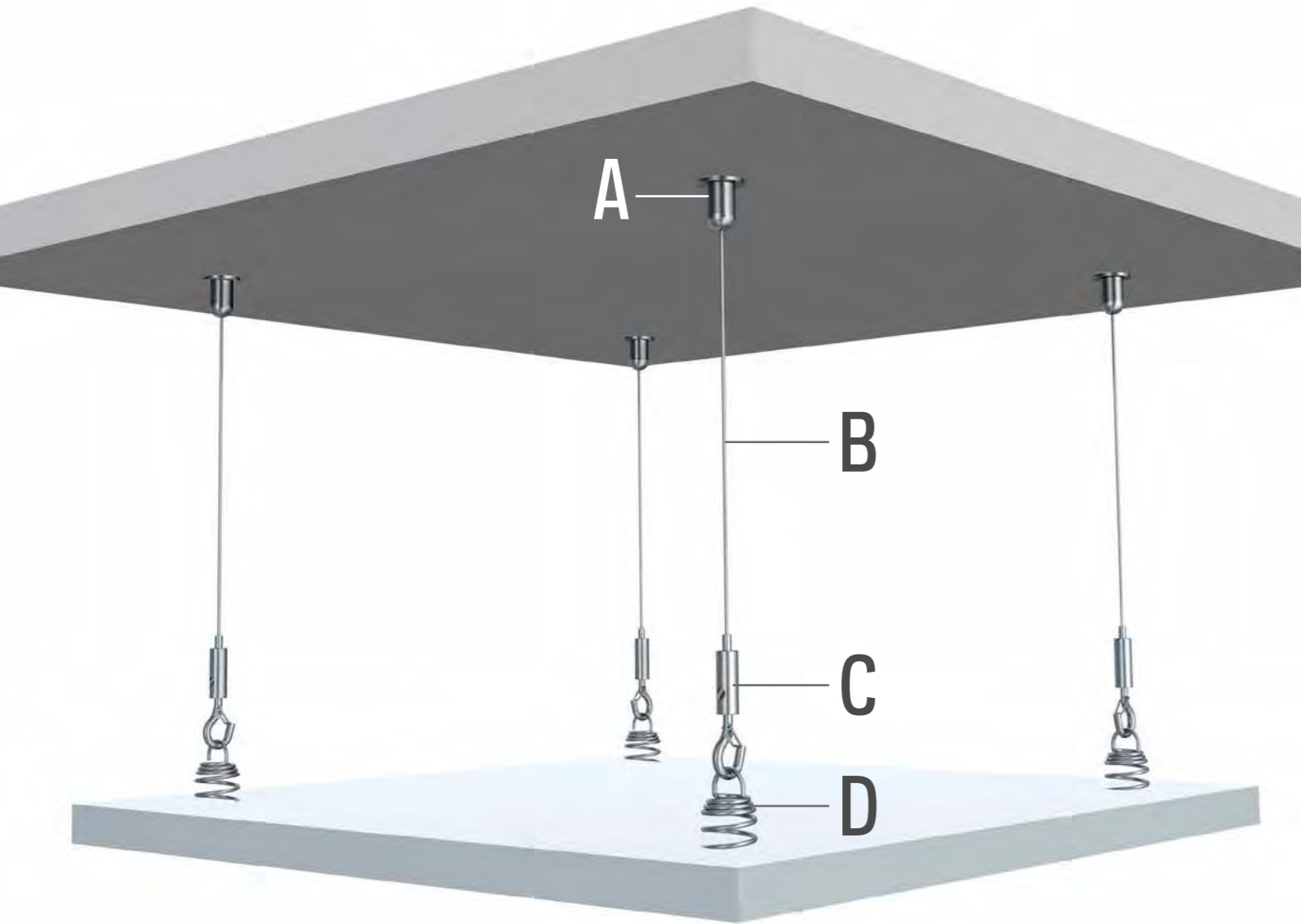











CEILING ACOUSTIC



COMBINATION SHOWN:
A2 + B2 + C4 + D

POSSIBLE COMBINATIONS:
A1/A2 + B1/B2 + C1/C2/C3/C4 + D
A3 + B3 + C1/C2/C3/C4 + D

CEILING ACOUSTIC

A	A1			A2			A3	
								
	CEILING BRACKET BLACK C01BL 7807.100	PLUG (0.5 mm) 9.4931	SCREW 9.4929	CEILING BRACKET NICKEL C01NI 7807.110	PLUG (0.5 mm) 9.4931	SCREW 9.4929	CEILING SUSPENSION AUTO GRIP 1,2 mm CS01NI 7807.140	
B	B1		B2		B3			
								
	STEELWIRE + SLIDER 1,2 mm 200 cm BLACK 7807.200		STEELWIRE + SLIDER 1,2 mm 200 cm NICKEL 7807.210		STEELWIRE 7 X 7 1,2 mm 10 M 7807.350			
C	C1	C2	C3	C4				
								
	STEELWIRE HOOK AUTO GRIP 1,2 mm ST01BL 7807.010	STEELWIRE HOOK AUTO GRIP 1,2 mm ST01NI 7807.020	STEELWIRE HOOK AUTO GRIP 1,2 mm ST02NI 7807.030	STEELWIRE HOOK AUTO GRIP 1,2 mm ST03NI 7807.040				
D	D							
								
ACOUSTIC SPRING 01-NI 7807.400								



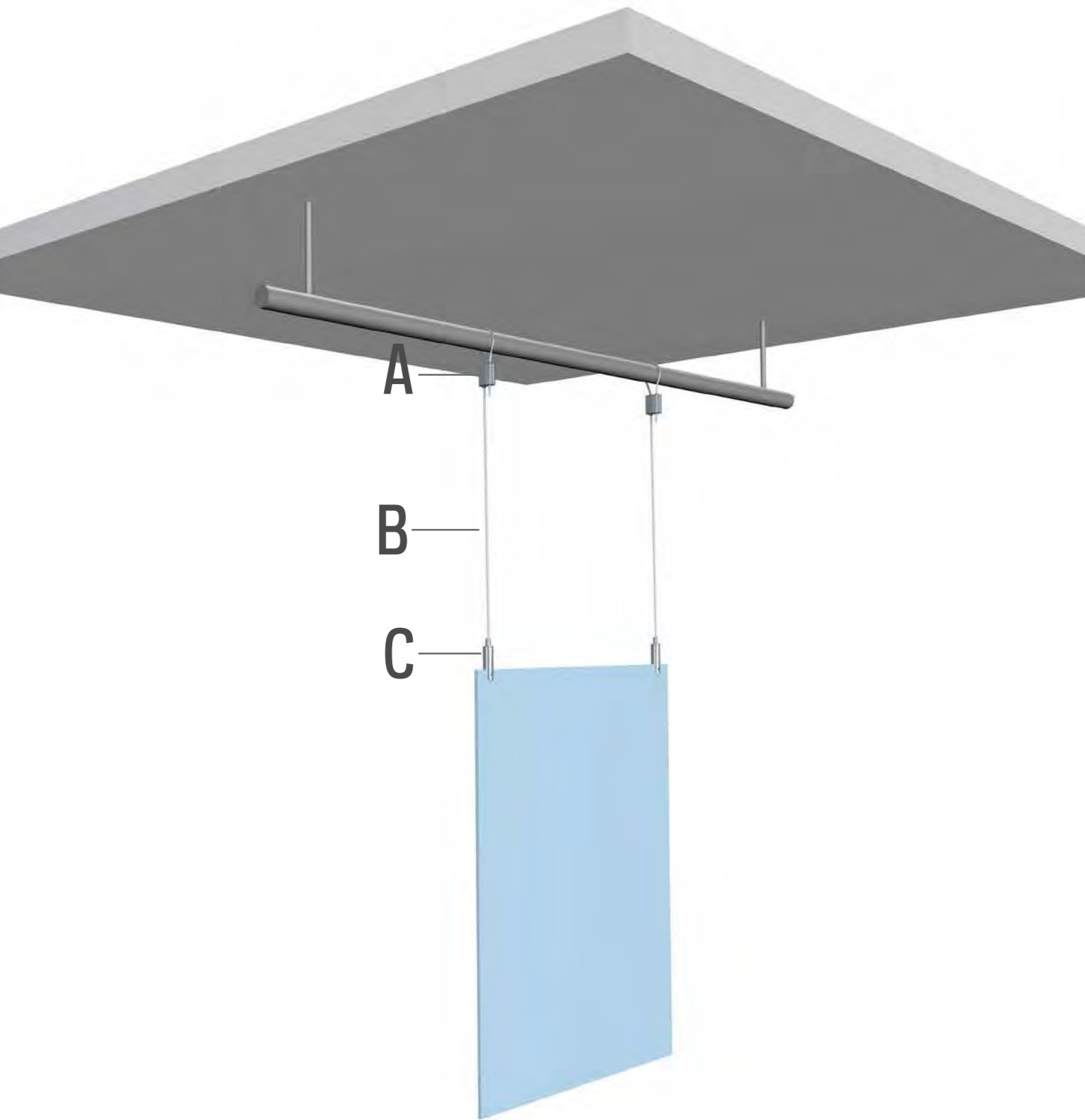





LOOP HANGER



COMBINATION SHOWN:
A + B + C5

POSSIBLE COMBINATIONS:
A + B + C1/C2/C3/C4/C5

LOOP HANGER

A	A		B							
										
	LOOP HANGER 1.0 - 1.5 mm		STEELWIRE 7 X 7 1.2 mm 10 M							
	7805.052		7807.350							
C	C1		C2		C3		C4		C5	
										
	STEELWIRE HOOK AUTO GRIP 1.2 mm ST01BL		STEELWIRE HOOK AUTO GRIP 1.2 mm ST01NI		STEELWIRE HOOK AUTO GRIP 1.2 mm ST02NI		STEELWIRE HOOK AUTO GRIP 1.2 mm ST03NI		STEELWIRE CLAMPHOOK AUTO GRIP 1.2 mm STC01NI	
	7807.010		7807.020		7807.030		7807.040		7807.050	

COMPLETE SETS



D



E

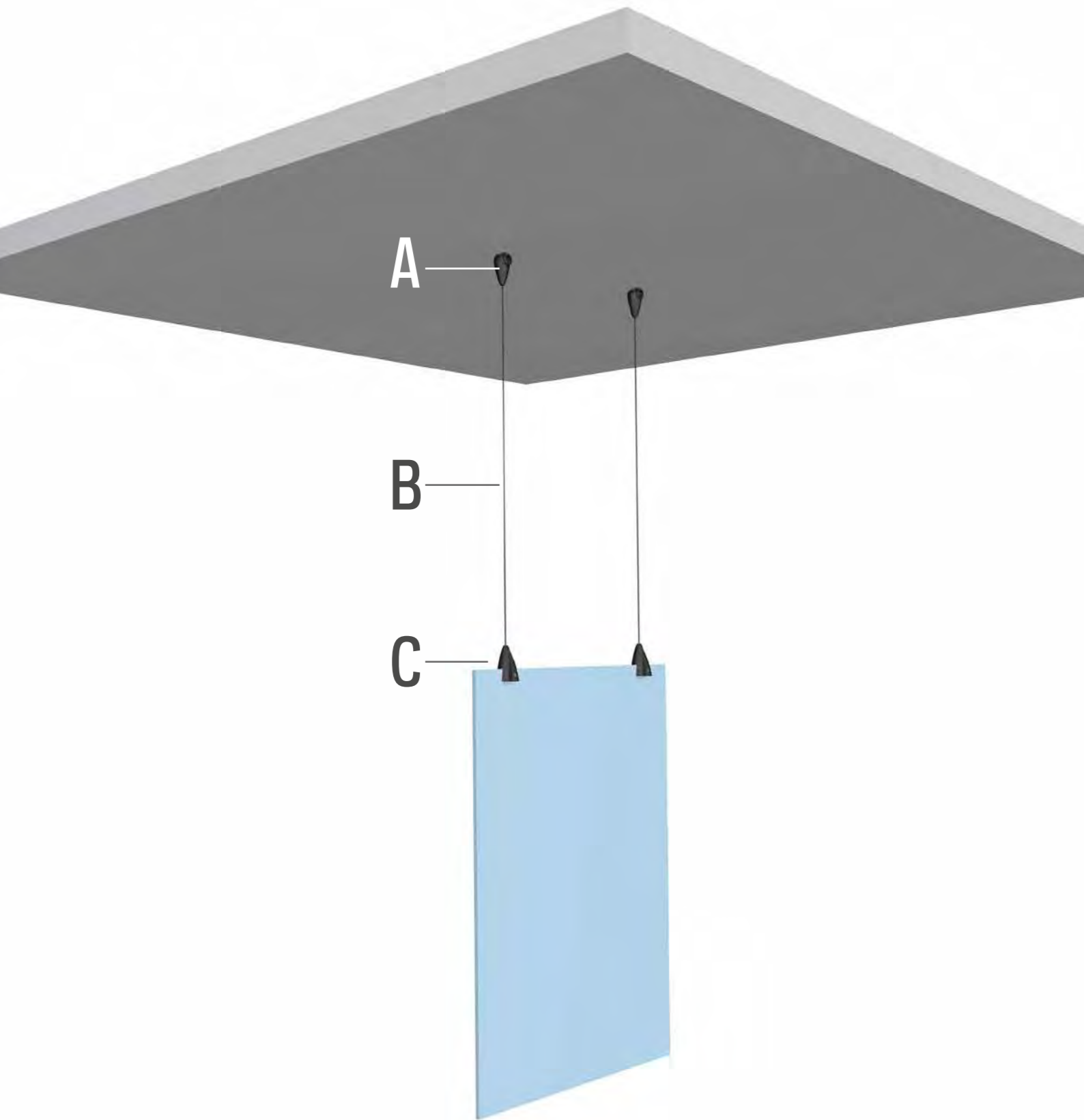

COMPLETE SET D		COMPLETE SET E	
			
SET LOOP HANGER + HOOK 200 cm		SET LOOP HANGER + LOOP 200 cm	
7840.300		7840.310	

UNI HANGER / PANEL GRIPS



UNI HANGER / PANEL GRIPS

A		
		
UNI HANGER	PLUG (Ø 5 mm)	SCREW
7806.150	9.4931	9.4929

B		
B1	B2	B3
		
TWISTER 1 mm STEELWIRE BLACK 150 cm	TWISTER 1 mm STEELWIRE BLACK 200 cm	TWISTER 1 mm STEELWIRE BLACK 300 cm
09.63150	09.63200	09.63300

C

PANEL GRIP BLACK (1-4 mm PANEEL)
7806.140

SIGN HANGING SYSTEMS



Artiteq has selected the Fischer UX 5x30 R plug to be used in combination with its hanging systems. The Fischer UX 5x30 R plug can be used in different kinds of materials, such as concrete, stone and plasterboard. Depending on the material, the plug can support a maximum load of 30 kg. The drill used with the plug must have a diameter of 5 mm. The plug is 30 mm in length. The screw used with the plug is 38 mm long and has a diameter of 3.5 mm (to be used in combination with a PZ2 bit).

To determine the maximum load of a signing hanging system, it must be known what type of mounting materials will be used and what surface (i.e. type of material) these will be attached to. The components of the signing hanging system all have a maximum bearing capacity. This is the maximum bearing capacity for the component itself and not the maximum bearing capacity that must be taken into account for the system as a whole. For the whole system, the load capacity that is recommended for the mounting material in combination with the respective base material, takes precedence.

For every signing hanging system, the weight that you wish to hang must be balanced against the maximum load capacity of the mounting material. If systems are hung from other hanging components, such as recessed ceilings, you have to know the maximum load of this hanging component before fitting our systems. The tables below show the maximum load capacity for the Fischer plug in combination with different materials and the maximum bearing capacity for each component for the different signing hanging systems.

TYPE	UX 5X 30		
RECOMMENDED LOADS IN THE RESPECTIVE BASE MATERIAL F_{REC}²⁾			
Concrete	≥ C20/25	[kN]	0,30
Solid brick	≥ Mz 12	[kN]	0,20
Perforated sand-lime brick	≥ KSL 12	[kN]	0,30
Vertically perforated brick	≥ Hlz 12	[kN]	0,20
Aerated concrete	≥ AAC 4	[kN]	0,15
Gypsum plasterboard	12,5 mm	[kN]	0,10
Gypsum plasterboard	25 mm	[kN]	0,10
Gypsum fibreboard	(Fermacell)	[kN]	0,20
Gypsum block	ρ ≥ 0,9 kg/dm³	[kN]	-

ART. NO.	DESCRIPTION	MAX. LOAD CAPACITY
7807.060	Suspension bracket Xpo Rail 1,2 mm	15 kg
7807.200	Steelwire + slider 1,2 mm 200 cm black	15 kg
7807.210	Steelwire + slider 1,2 mm 200 cm nickel	15 kg
7807.100	Ceiling Bracket black C01BL	15 kg
7807.110	Ceiling Bracket nickel C01NI	15 kg
7807.140	Ceiling Suspension auto grip 1,2 mm CS01NI	15 kg
7807.350	Steelwire 7x7 1,2 mm 10 m	15 kg
7805.052	Loop Hanger 1,0 mm - 1,5mm	10 kg
7807.120	Recessed Ceiling Clip 20 mm	5 kg
7807.130	Recessed Ceiling Clip 20 mm + suspension auto grip 1,2 mm	5 kg
7807.310	Steelwire + hook 1,2 mm 300 cm	15 kg
7807.010	Steelwire Hook auto grip 1,2 mm ST01BL	15 kg
7807.020	Steelwire Hook auto grip 1,2 mm ST01NI	15 kg
7807.030	Steelwire Hook auto grip 1,2 mm ST02NI	15 kg
7807.040	Steelwire Hook auto grip 1,2 mm ST03NI	15 kg
7807.400	Acoustic Spring 01-NI	5 kg
7807.050	Steelwire Clamphook auto grip 1,2 mm STC01NI	15 kg



1 Required safety factors are considered.
2 Valid for tensile load, shear load and oblique load under any angle

► SALES SUPPORT



HIGH QUALITY
MULTIFUNCTIONAL
DESIGN

DISPLAYS & DEMONSTRATION TOOLS



DISPLAY HANGING SOLUTIONS MICRO GRIP		
3291C	DISPLAY HANGING SOLUTIONS MICRO GRIP	50x34x212 cm

CONTENT DISPLAY HANGING SOLUTIONS MICRO GRIP (3291C)		QUANTITY
9.7130	ALL-IN-ONE KIT 2 m CLICK MICRO GRIP RAIL WHITE PRIMER	12
9.7131	ALL-IN-ONE KIT 4 m CLICK MICRO GRIP RAIL WHITE PRIMER	8
9.7090	MICRO GRIP 2 mm (2X)	10
9.7091	TWISTER 2 mm PERLON 2mm 200 cm + MICRO GRIP 2 mm	10
9.7092	TWISTER 2 mm PERLON 2mm 200 cm (2X)	5
9.7093	INSTALLATION SET CLICK RAIL 2 m	5
9.7094	PICTURE MOUSE SOLO	5
9.7141	INFO RAIL RETAIL PACK WHITE 100 cm	5

CONTENT DISPLAY 3291C:

INFO RAIL RETAIL PACK



9.7141	INFO RAIL RETAIL PACK WHITE 100 cm
--------	------------------------------------

SEE PAGE 96 FOR INFO RAIL

CONTENT DISPLAY 3291C:

ALL-IN-ONE CLICK RAIL WHITE PRIMER TWISTER MICRO GRIP 20 KG HOOK

COMPLETE SET 2m

	1x 2m 	6x 	2x 	2x
	CLICK RAIL WHITE PRIMER RAL 9016	FASTENER MATERIAL	END CAP	MICRO GRIP 2 mm + TWISTER 2 mm PERLON
ARTICLE NO.	9.7130			

COMPLETE SET 4m

	2x 2m 	12x 	2x 	3x
	CLICK RAIL WHITE PRIMER RAL 9016	FASTENER MATERIAL	END CAP	MICRO GRIP 2 mm + TWISTER 2 mm PERLON
ARTICLE NO.	9.7131			

SEE PAGE 8 FOR CLICK RAIL

CONTENT DISPLAY 3291C:

ACCESSORIES RETAIL SETS

	9.7090	MICRO GRIP 2 mm (2x)
	9.7091	TWISTER 2 mm PERLON 200 cm + MICRO GRIP 2 mm
	9.7092	TWISTER 2 mm PERLON 200 cm (2x)
	9.7093	INSTALLATION SET CLICK RAIL 2 m
	9.7094	PICTURE MOUSE SOLO

DISPLAYS & DEMONSTRATION TOOLS



DISPLAY ART HANGING SOLUTIONS XS		
3290C	DISPLAY AHS XS	50 x 34 x 212 cm

CONTENT DISPLAY ART HANGING SOLUTIONS XS		QUANTITY
9.7051	END CAP WHITE (2x)	6
9.7053	CORNER CONNECTOR (2x)	6
9.7055	CLICK & CONNECT (6x) + SCREWS + PLUGS	6
9.7076	TWISTER 2 mm PERLON 200 cm (2x)	12
9.7058	HOOK 15 kg (2x)	6
9.7082	HOOK 4 kg + TWISTER 2 mm PERLON 150 cm	6
9.7075	HOOK 4 kg (2x)	6
9.7083	HOOK 15 kg + TWISTER 2 mm PERLON 150 cm	6
9.4348	CLICK RAIL WHITE PRIMER 200 cm	20
9.7162	ALL-IN-ONE KIT CLICK RAIL WHITE PRIMER 200 cm	12
	BROCHURE	25
3290	DISPLAY	1

ACCESSORIES RETAIL SETS



9.7051	END CAP WHITE (2x)
9.7053	CORNER CONNECTOR (2x)
9.7055	CLICK & CONNECT (6x) + SCREWS+ PLUGS
9.7076	TWISTER 2 mm PERLON 200 cm (2x)
9.7058	HOOK 15 kg (2x)
9.7082	HOOK 4 kg + TWISTER 2 mm PERLON 150 cm
9.7075	HOOK 4 kg (2x)
9.7083	HOOK 15 kg + TWISTER 2 mm PERLON 150 cm

ALL-IN-ONE CLICK RAIL TWISTER 15 KG HOOK

RETAIL SETS

COMPLETE SET 2m

	 1x 2m	 6x	 2x	 150 cm 2x max. 15 kg
	CLICK RAIL WHITE PRIMER RAL 9016	FASTENER MATERIAL	END CAP	HOOK 15 kg + TWISTER 2 mm PERLON
ARTICLE NO.	9.7162			

COMPLETE SET 2m

	 1x 2m	 6x	 2x	 150 cm 2x max. 15 kg
	CLICK RAIL WHITE RAL 9010	FASTENER MATERIAL	END CAP	HOOK 15 kg + TWISTER 2 mm PERLON
ARTICLE NO.	9.7161			

COMPLETE SET 2m

	 1x 2m	 6x	 2x	 150 cm 2x max. 15 kg
	CLICK RAIL ALU BRUSHED	FASTENER MATERIAL	END CAP	HOOK 15 kg + TWISTER 2 mm PERLON
ARTICLE NO.	9.7163			

COMPLETE SET 2m

	 1x 2m	 6x	 2x	 150 cm 2x max. 15 kg
	CLICK RAIL ALU BRUSHED	FASTENER MATERIAL	END CAP	HOOK 15 kg + TWISTER 2 mm STEELWIRE
ARTICLE NO.	9.7164			

DISPLAYS & DEMONSTRATION TOOLS

DEMONSTRATION TOOLS



DEMONSTRATION BOARDS	
9.5730	DEMOBOARD CLICK RAIL PRO 50 x 130 cm
9.5731	DEMOBOARD COMBI RAIL PRO LIGHT 50 x 130 cm
9.5732	DEMOBOARD CLASSIC RAIL + CLASSIC RAIL+ 50 x 130 cm
9.5733	DEMOBOARD DECO RAIL 50 x 130 cm
9.5735	DEMOBOARD DISPLAY IT FIXED + FLEX 50 x 130 cm
9.5737	DEMOBOARD MAGNETIC SOLUTIONS 50 x 130 cm
9.5739	DEMOBOARD WHITEBOARDSET + PARTITION WALL HOOKS 50 x 130 cm
9.5740	DEMOBOARD CONTOUR RAIL 50 x 130 cm
9.5741	DEMOBOARD LOOP HANGER 50 x 130 cm
9.5742	DEMOBOARD INFO RAIL + INFO RAIL ME 50 x 130 cm
9.5743	DEMOBOARD CLICK FRAMES + POSTER SNAP 50 x 130 cm
9.5745	DEMOBOARD SHADOWLINE 50 x 130 cm
9.5746	DEMOBOARD ARTSTRIP + CEILING STRIP 50 x 130 cm
9.5747	DEMOBOARD TOP RAIL + UP RAIL 50 x 130 cm



FLOORDISPLAY (DOUBLE-SIDED)	
3324	DISPLAY (150 cm HEIGHT, 40 cm WIDTH)
CHOOSE 2 PANELS:	
9.5801	PICTURE HANGING SYSTEMS - WALL SYSTEMS
9.5802	PICTURE HANGING SYSTEMS - CEILING/INTEGRATED SYSTEMS
9.5803	PICTURE HANGING SYSTEMS - FRAME ACCESSORIES
9.5807	PICTURE HANGING SYSTEMS - SOLO SYSTEMS
9.5805	DISPLAY HANGING SYSTEMS - CABLE SYSTEMS
9.5808	DISPLAY HANGING SYSTEMS - RAIL SYSTEMS
9.5804	SIGN HANGING SYSTEMS
9.5806	SIGN HANGING SYSTEMS - RAIL
9.5809	PRESENTATION SYSTEMS - DISPLAY IT LED FLEX
9.5810	PRESENTATION SYSTEMS - DISPLAY IT LED FIXED

DISPLAYS & DEMONSTRATION TOOLS

DEMONSTRATION TOOLS

SAMPLE KIT		
3250	PICTURE HANGING SYSTEMS - INTEGRATED	15,5 x 7,5 x 7,5 cm
3252	SAMPLE KIT PICTURE HANGING SYSTEMS - WALL (CONTOUR RAIL / CLICK RAIL / CLICK RAIL PRO)	25 x 12,5 x 2,5 cm
3254	SAMPLE KIT PICTURE HANGING SYSTEMS - CEILING (ART STRIP / TOP RAIL)	25 x 12,5 x 2,5 cm



DEMONSTRATION CASE		
5038	DEMONSTRATION CASE + SET 3 INLAYS WITH SAMPLES	58 x 40 x 12 cm
5038A	SET 3 INLAYS WITH SAMPLES	



BROCHURES

ARTICLE NO.	DESCRIPTION
2740	ARTITEQ PRODUCT CATALOGUE NL
2741	ARTITEQ PRODUCT CATALOGUE EN
2742	ARTITEQ PRODUCT CATALOGUE FR
2743	ARTITEQ PRODUCT CATALOGUE DE
2490	BROCHURE FOR SCHOOLS NL
2491	BROCHURE FOR SCHOOLS EN
2492	BROCHURE FOR SCHOOLS FR
2493	BROCHURE FOR SCHOOLS DE
2494	BROCHURE INTEGRATED SYSTEMS NL
2495	BROCHURE INTEGRATED SYSTEMS EN
2496	BROCHURE INTEGRATED SYSTEMS FR
2497	BROCHURE INTEGRATED SYSTEMS DE
2680	BROCHURE B2B NL
2681	BROCHURE B2B EN
2685	BROCHURE BACK FRAME HANGING SYSTEM NL
2686	BROCHURE BACK FRAME HANGING SYSTEM EN

ARTICLE NO.	DESCRIPTION
3746	BROCHURE ENJOY LIFE LOVE LIVING NL
3747	BROCHURE ENJOY LIFE LOVE LIVING EN
3748	BROCHURE ENJOY LIFE LOVE LIVING FR
3450	BROCHURE ENJOY LIFE LOVE LIVING DE
2602	BROCHURE IMAGINE IT NL
2603	BROCHURE IMAGINE IT FR
2604	BROCHURE IMAGINE IT DE
2605	BROCHURE IMAGINE IT EN
2725	BROCHURE DISPLAY IT LED NL
2726	BROCHURE DISPLAY IT LED EN
2727	BROCHURE DISPLAY IT LED DE
2728	BROCHURE DISPLAY IT LED FR
1059	MINI CATALOGUE



INDEX

ARTICLE NO.	PAGE	ARTICLE NO.	PAGE	ARTICLE NO.	PAGE	ARTICLE NO.	PAGE	ARTICLE NO.	PAGE
05.01210	8	05.16050	72	05.75362	32	2493	135	30.41200	60/63
05.01310	8	05.16060	72	09.09166	79	2494	135	30.41250	60/63
05.05320	10	05.16300	72	09.13100	59	2495	135	30.42100	65
05.05330	10	05.16301	72	09.13150	59	2496	135	30.42150	65
05.05420	10	05.17010	72	09.13200	59	2497	135	30.42200	65
05.05430	10	05.17300	72	09.13250	59	2563	22	3199	132/133
05.06010	22/38	05.17301	72	09.13300	59	2602	135	3250	135
05.06020	22	05.47100	94	09.23100	59	2603	135	3252	135
05.06200	22	05.47150	98	09.23150	59	2605	135	3254	135
05.06300	22	05.47160	96	09.23200	45/59	2606	135	3255	135
05.07310	34	05.47170	96	09.23250	59	2620	135	3289	19
05.08310	34	05.47200	98	09.23300	59	2621	135	3290	132/133
05.08320	35	05.53100	98	09.23500	59	2622	135	3291C	130/131
05.08330	35	05.53200	98	09.33100	59	2623	135	3301	135
05.08410	37	05.54025	96	09.33150	59	30.11200	12/13	3324	130
05.08420	36	05.54050	96	09.33200	59	30.11201	12/13	3746	135
05.09166	81/83	05.54100	96	09.33250	59	30.11300	12/13	3747	135
05.10166	81/83	05.54200	96	09.33300	59	30.11301	12/13	3748	135
05.13099	102	05.54300	96	09.33500	59	30.21150	59	3750	135
05.13133	102	05.55025	96	09.63150	125	30.21200	59	40.11200	14
05.13166	102	05.55050	96	09.63200	125	30.21220	38	40.11300	14
05.14010	102	05.55100	96	09.63300	125	30.21300	59	40.21200	14
05.14099	102	05.55200	96	1015	30	30.22150	59	40.21500	14
05.14133	102	05.55300	96	1016	30	30.22200	59	40.21700	14
05.14166	102	05.56025	92	1017	32	30.22300	59	40.31300	14
05.15010	115	05.56100/200	92	1059	135	30.31110	38	40.31500	14
05.15020	115	05.60100	103	2386	8	30.31180	13	40.32060	14
05.15030	113/115	05.60200	103	2387	11	30.31210	12/38	40.32100	14
05.15200	115	05.61100	103	2388	12	30.31220	13/39	40.32300	14
05.15201	113/115	05.61200	103	2389	17	30.31310	12/39	40.41120	14
05.15202	115	05.75100	30/32	2390	24	30.31320	12/39	40.41135	14
05.16010	72	05.75110	30	2490	135	30.31330	12/39	40.41150	14
05.16030	72	05.75126	30	2491	135	30.31340	12/39	40.41303	14
05.16040	72	05.75213	30	2492	135	30.41100	60/63	40.41306	14

INDEX

ARTICLE NO.	PAGE	ARTICLE NO.	PAGE	ARTICLE NO.	PAGE	ARTICLE NO.	PAGE	ARTICLE NO.	PAGE
40.41308	14	5038A	135	7803.301	85/91	7807.310	119	9.4105	38
4050	77	5092	111	7803.302	85/91	7807.350	113/117/119/ 121/123	9.4107	38
4051	77	5093	111	7804.210	83/103	7807.400	121	9.4108	38
40.51350	54	5094	8/39	7804.220	83/103	7807.900	113/117/119/ 121/123	9.4112	38
40.51360	54	5095	8/39	7804.310	83/103	7820.200	81/83	9.4113	38
4054	76	7020.021	108	7804.320	83/103	7820.210	81/83	9.4114	38
4055	76	7025.030	108	7805.001	89/91	7820.220	81/83	9.4119	38
4056	77	7025.084	108	7805.002	89/91	7820.400	89	9.4120	38
4057	76	7220.110	100	7805.003	91	7830.401	89	9.4121	38
4058	76	7350.050	108	7805.005	89/91	7835.040	103	9.4122	38
4059	76	7350.070	108	7805.007	65/68	7840.100	68	9.4123	38
4060	8/39	7350.100	108	7805.014	68	7840.150	45	9.4124	38
4061	8/39	7350.120	108	7805.016	68	7840.220	44	9.4151	17
4064	8/39	7410.001	47	7805.030	45	7840.240	44	9.4152	17
4065	8/39	7410.002	47	7805.040	45	7840.300	123	9.4153	17
4066	10/39	7410.003	47	7805.042	44	7840.310	123	9.4155	17
4067	10/39	7410.004	47	7805.050	76	7840.320	123	9.4161	17
4068	24/39	7430.001	89	7805.052	123	7840.330	123	9.4162	17
4069	24/39	7430.010	68/100	7805.055	76	805.249	72	9.4163	17
4070	24/39	7430.020	68/100	7806.140	123	807.025	77	9.4165	17
4071	17/18	7600.110	42	7806.150	123	808.130	77	9.4170	17
4072	17/18/39	7600.120	42	7807.010	113/115/117/ 119/121/123	808.600	77	9.4171	17
4073	10/39	7700.003	85	7807.020	113/115/117/ 119/121/123	808.650	77	9.4188	91
4074	10/39	7700.004	85	7807.030	113/115/117/ 119/121/123	808.720	77	9.4196	59
4075	24/39	7706.003	85/87	7807.040	113/115/117/ 119/121/123	809.001	77	9.4198	59/91
4076	24/39	7706.004	85/87	7807.050	113/115/117/ 119/121/123	809.002	77	9.4205	60/63
4077	24/39	7710.010	85	7807.060	113	809.500	77	9.4207	60/63
4078	17/18/39	7710.020	85	7807.100	113/117/121	809.510	77	9.4208	60/63
4079	17/18/39	7710.030	87	7807.110	113/117/121	809.520	77	9.4209	60/63
4098	22/39	7720.183	85	7807.120	119	809.530	77	9.4211	77
4099	22/39	7730.060	85	7807.130	119	809.540	77	9.4216	17
50.51370	54	7730.200	85	7807.140	113/117/121	9.3390	19	9.4217	17
50.51380	54	7803.211	85/91	7807.200	113/115/ 117/121	9.3394	45	9.4218	67
5038	135	7803.212	85/91	7807.210	113/115/ 117/121	9.4104	38	9.4219	60/63

ARTICLE NO.	PAGE	ARTICLE NO.	PAGE	ARTICLE NO.	PAGE	ARTICLE NO.	PAGE	ARTICLE NO.	PAGE
9.4220	19	9.4313	24	9.4414	45	9.4979	47	9.6672	65
9.4221	19	9.4314	24	9.4415	45	9.4990	76	9.6674	65
9.4222	19	9.4318	18	9.4416	45	9.5522	76	9.6740	104
9.4235	65	9.4319	18	9.4421S	76	9.5621	50	9.6741	105
9.4237	17	9.4320	18	9.4424	46	9.5622	51	9.7051	132/133
9.4238	47	9.4321	18	9.4425	46	9.5623	51	9.7053	132/133
9.4239	47	9.4323	24	9.4426	46	9.5627	50	9.7055	132/133
9.4241	45	9.4324	24	9.4427	46	9.5628	51	9.7058	132/133
9.4244	17	9.4326	24	9.4428	46	9.5629	50	9.7061	132/133
9.4246	47	9.4327	24	9.4430	76	9.5630	51	9.7062	132/133
9.4247	47	9.4339	8	9.4431	76	9.5730	134	9.7063	132/133
9.4248	47	9.4340	8	9.4500	47	9.5731	134	9.7064	132/133
9.4253	19	9.4341	8	9.4503	46	9.5732	134	9.7075	132/133
9.4255	19	9.4342	8	9.4504	46	9.5733	134	9.7076	132/133
9.4256	19	9.4343	8	9.4506	46	9.5735	134	9.7082	132/133
9.4261	60/63	9.4346	8	9.4510	66	9.5737	134	9.7083	132/133
9.4262	60/63	9.4348	8/128/129	9.4540	47	9.5739	134	9.7090	130/131
9.4271	19	9.4349	8	9.4541	47	9.5740	134	9.7091	130/131
9.4272	19	9.4350	8	9.4550	93	9.5741	134	9.7092	130/131
9.4273	19	9.4351	8	9.4900	24/38	9.5742	134	9.7093	130/131
9.4274	19	9.4353	8	9.4901	38	9.5743	134	9.7094	130/131
9.4277	19	9.4354	8	9.4902	38	9.5745	134	9.7130	53/130/131
9.4278	19	9.4357	17	9.4903	38	9.5746	134	9.7131	53/130/131
9.4279	19	9.4358	17	9.4904	76	9.5747	134	9.7141	130/131
9.4280	19	9.4362	24	9.4905	76	9.5801	134	9.7161	52/132/133
9.4290	19	9.4367	24	9.4911	76	9.5802	134	9.7162	52/132/133
9.4291	19	9.4372	8	9.4912	38	9.5803	134	9.7163	52/132/133
9.4293	19	9.4378	24	9.4913	38	9.5804	134	9.7164	52/132/133
9.4303	8	9.4379	24	9.4928	38	9.5805	134	9.9004	65
9.4304	8	9.4390	17	9.4929	38/113/115/ 117/121/125	9.5806	134		
9.4305	17	9.4391	17	9.4931	38/113/115/ 117/121/125	9.5807	134		
9.4306	17	9.4400	65	9.4955	76	9.5808	134		
9.4307	17	9.4402	65	9.4975	47	9.6644	67		
9.4308	17	9.4404	76	9.4976	47	9.6645	65		
9.4309	24	9.4412	47	9.4977	47	9.6670	65		
9.4310	24	9.4413	47	9.4978	47	9.6671	65		

ARTITEQ
HERASTRAAT 39
5047 TX TILBURG
THE NETHERLANDS
T +31 (0)13 572 90 70
F +31 (0)13 572 90 75
INFO@ARTITEQ.COM
WWW.ARTITEQ.COM

