

Broad range of position adjustment is suitable for more requirements by surgery department

OP750 is a manual operating table fully meeting various request by different surgery departments. It provides various positions through simple and accurate operation while ensuring patients' safety and comfort. Cost-effective OP750 with versatility is the ideal choice for modern operation room.

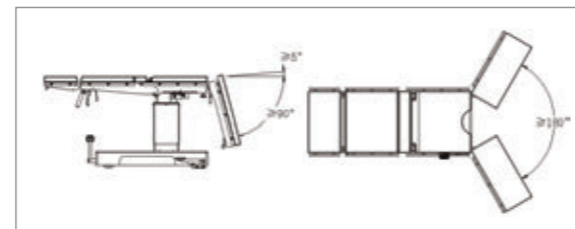
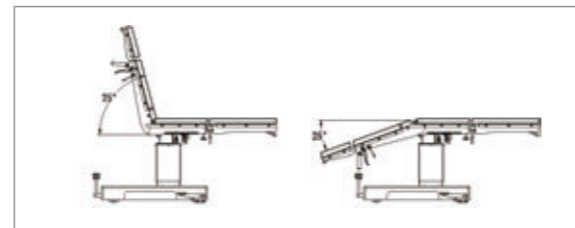
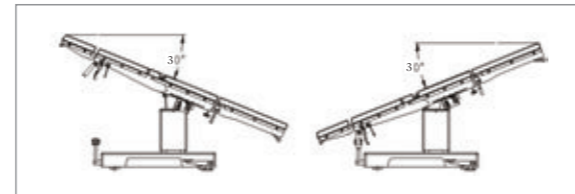
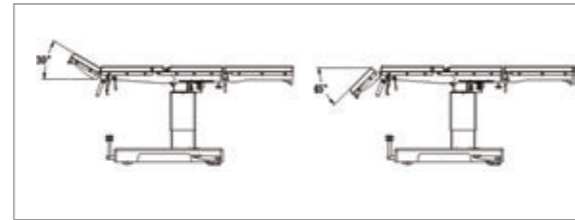
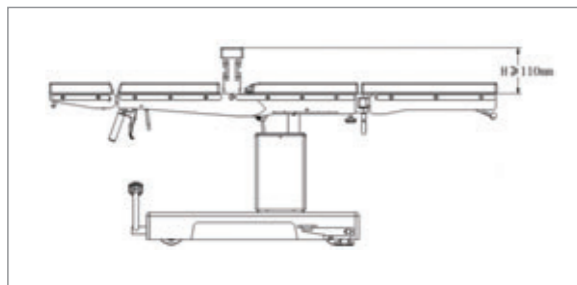
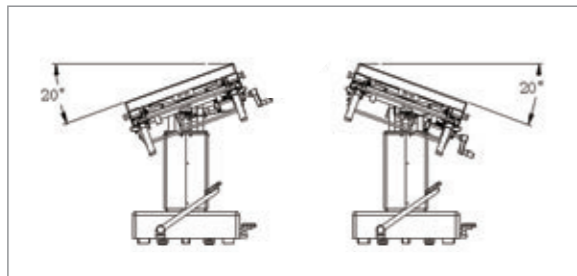
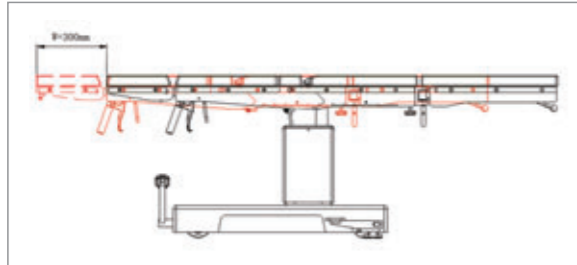
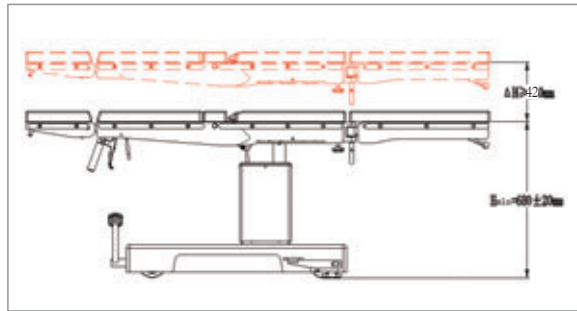

#### Technical Specifications:

- Table length: 2020mm
- Table Width(without side rails): 520mm
- Table Height(without mattress): 680mm-940mm
- Trendelenburg/Reverse: 20°/20°
- Lateral Tilt(left/right): 20°/20°
- Back Plate Up/Down: 75°/25°
- Head Plate Up/Down: 30°/45°(removable)
- Leg Plate Up/Down: 5°/90°
- Leg Plate Split: 180°(removable)
- Kidney-bridge Elevator UP: 110mm
- Longitudinal Shift (optional): 300mm
- Weight Capacity: 297kg

**aeomed**  
Reliable Quality Thoughtful Service

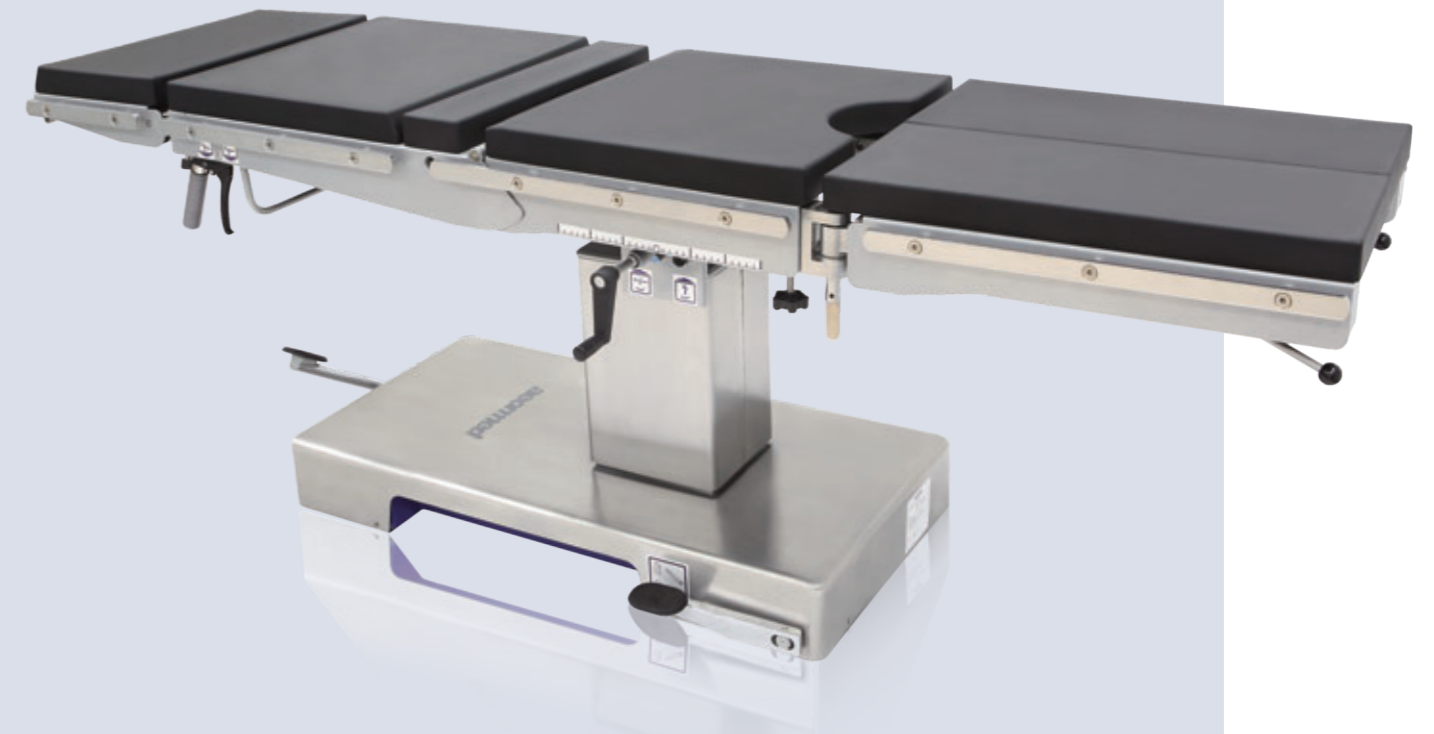

## Aegistab OP750 Manual Operating Table

**aeomed**  
Beijing Aeonmed Co.,Ltd.

Office (Headquarters):  
Add: 11B2, Fengtai Science Park,(100070) Beijing, China  
Tel: +86-10-8368 1616 Fax: +86-10-6371 8989  
http://www.aeonmed.com E-mail:int@aeomed.com

Information contained in this leaflet is correct at the date of publication. The policy of Beijing Aeonmed Co., Ltd. is one of the continued improvement to its products. Because of this policy Beijing Aeonmed Co., Ltd. reserves the right to make any change, which may affect the information in this leaflet without giving prior notices.

Print in July.2012

www.aeonmed.com

- Main structure of operating table is made of high-grade steel.
- Base, column casing, accessories rails, and metal accessories are made of stainless steel.
- Stable structure, nice shape, easy to clean

- ①
- Functional displays below are controlled by import cylinder: head plate up and down, table trendelenburg and reverse trendelenburg, back plate up and down.
  - Easy to operate, accurately and stably positioning
  - Operation focuses on head without affecting surgery.



- ②
- Built-in kidney-bridge can be elevated up to 110mm.
  - Provides displays requested by kidney and gallbladder surgery



- ⑧
- Mattress made by high density PU foam is waterproof.
  - High elasticity and comfort
  - Removable design, nice shape, easy to clean, excellent perspective of X-ray

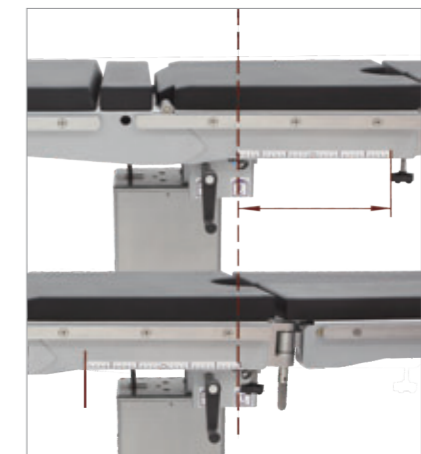
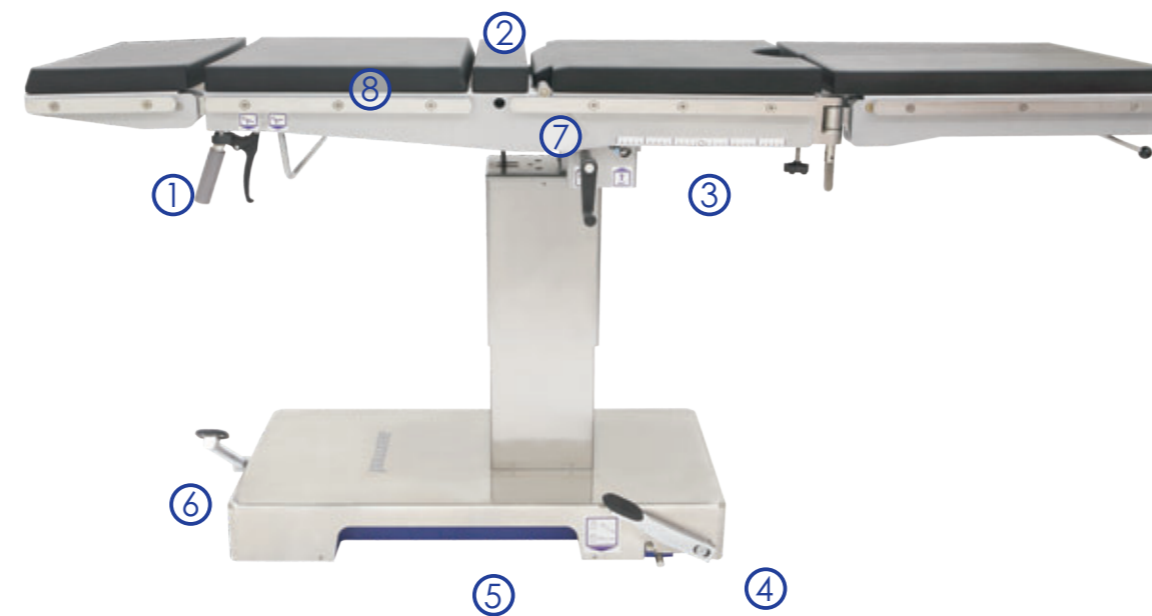

- ③
- Optional table longitudinal shift (up to 300mm) provides big enough space for X-ray work.



- ⑦
- Built-in X-ray film rail layer meets shoot request for different body parts during surgery.



- ④
- Operating table is easy to fix and shift with simple and efficient base-lock system.

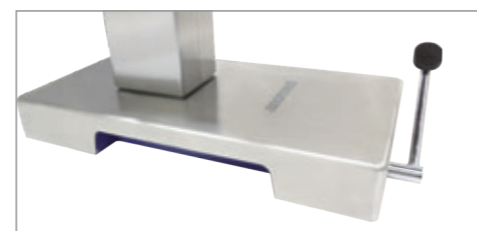

- ⑥
- Operating table up and down controlled by foot-lift pump, an integration structure of oil pump, fuel tank and crank
  - The integrate pump provides high stability of table during up and down operation and excellent carrying capacity.
  - Easy to operate, time-saving design

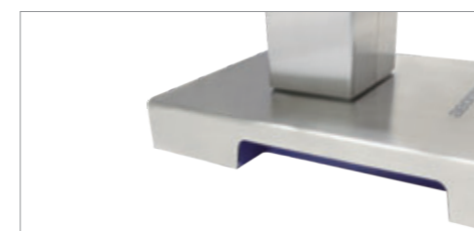

- ⑤
- Reserved space for feet in base meets close working on operating table while ensuring stability.