

Door Hardware Installation Instructions Dummy Handleset Optional Rosette (Round) Interior

Important!! There are **three** versions of installation instructions included with the hardware you ordered. The first (Version A) is for a dummy handleset with no hardware on the interior of the door. The second (Version B) is for an un-prepped door, meaning no holes have been bored in the face of the door but interior hardware will be used. The third and final version (Version C) is for a prepped door with interior hardware. We have included exploded parts drawings **Figure #1 - Version A, B and C** to assist you for each of the installations. Should you have any questions, please call our customer service department at 800-522-7336 and they will be happy to help!!

Step 1 Determine what Type of Installation is Required

- A) Determine if you will be using door hardware on the inside of your door (opposite to your handleset). If there will be **NO** door hardware on the inside of your door then you will automatically use **Version A** of these instructions. If there **WILL** be door hardware on the inside of your door, you will need to determine what type of installation is required. Grandeur's dummy handlesets can be installed on either prepped (pre-drilled) or un-prepped (no holes) doors, see **Figure #2**. Using the following chart, determine which installation best describes your project.

Is your door prepped? (see Figure #2 below)	
Yes	No
Use Version C - Page 7	Use Version B - Page 4

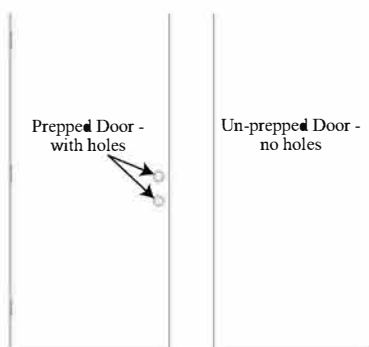

Figure #2

Version A

No Interior on an Un-prepped Door

Step 1

Select the Position of the Handleset

- A) In most cases, dummy handlesets are used next to a fully functional handleset on French (or double) doors. Always install the functional handleset first on the primary door, and then align the dummy handleset to match the functional one. Most people will choose to align two matching handlesets, so that they are positioned evenly on the two side-by-side doors. In these cases, it is best to align the lowest mounting holes on each grip as shown in **Figure #3**. Note: In some cases, dummy handlesets are used on single doors. In these cases, measure the height of another doorknob in the home. This will be the height at which the top portion of the grip is located, so that it is comfortable to use.

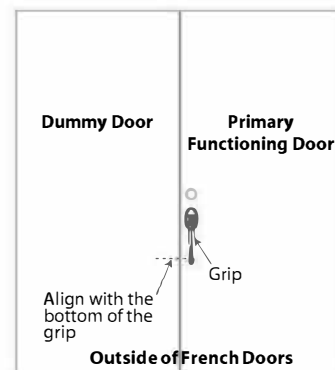

Figure #3

Step 2

Aligning the Handleset

- A) Measure the backset of the functional handleset. The backset measurement is the distance from the edge of the door to center of where you will drill your holes. This will either be 2-3/8" or 2-3/4".
- B) On the inside of the primary functioning door, remove the screw cover from the inside bottom of the functional handleset and take out the screw. Place a level at the height of the center of the screw hole. Once you have the level set level to the floor, mark the dummy door at this height. Then measure in the distance of your backset and mark this point where it crosses the screw hole height. See **Figure #4**. This will be referred to as the "base point".

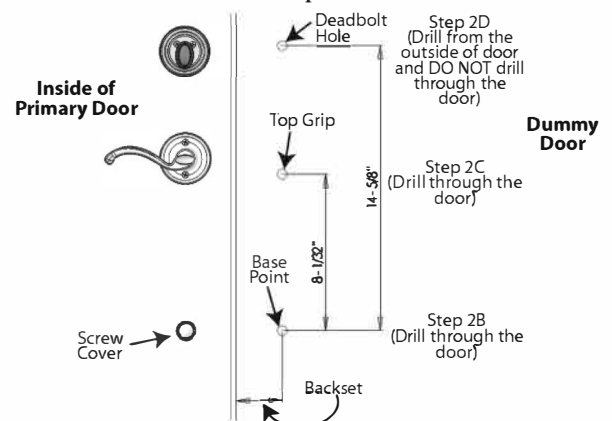

Figure #4

- C) Using the base point as your reference, measure up 8-1/32" and mark a horizontal line. Measure in from the edge of the door the distance of your backset and mark where the two lines cross. This will be the center of the top grip hole.
- D) Visually review the marks to verify that they line up well with the functional handleset on the primary door as shown in **Figure #4**. Note: The base point should be aligned horizontally with the center of the bottom screw hole (or screw cover) and the grip hole should be aligned horizontally with a point just below the knob on the primary door.

Step 3

Drill the Door

- A) Drill the base point hole and the top grip hole using a 7/32" bit. Drill these holes all the way through the door, being careful not to push the drill too hard, as this may result in splintering the outside of a wooden door. Always drill level and straight to minimize alignment issues, see **Figure #4** for reference.
- B) On the outside of the door, using the top grip hole that you just drilled as reference, measure up 6-5/8" and mark a horizontal line. Measure in from the edge of the door the distance of your backset and mark where the two lines cross. Note: This assumes a 5-1/2" center-to-center distance between the grip-set and deadbolt on the primary door. If the distance on the edge of your door between the center of the latch and the center of the deadbolt is not 5-1/2" you will have to make adjustments to visually match the dummy deadbolt and the primary door deadbolt. Drill the deadbolt hole using a 7/64" drill bit, making sure NOT to drill through the door. This hole only needs to be 3/4" deep.

Step 4

Install the Grip-set

- A) Using **Figure #1 - Version A** for reference, gather together the exterior grip-set (Part #1), with screw bosses (Part #1A & 1B), two screw cover adaptors (Part #2), two 2-1/2" mounting screws (Part #3), and two screw covers (Part #4). Insert the mounting screws through the screw cover adaptors as shown in **Figure #5**. Insert one mounting screw through the base point hole from the inside of the door. On the outside of the door, hold the grip-set in position and align the screw boss, (Part #1B) with the mounting screw as it comes through the door. Tighten down until nearly snug.

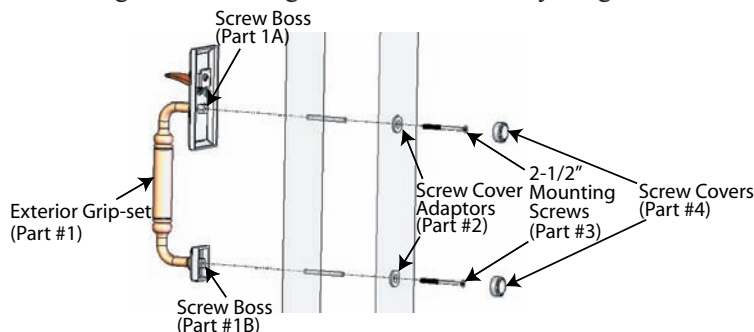

Figure #5

- B) Insert the other mounting screw through the top grip hole from the inside of the door. Align the top of the grip-set over the hole. The mounting screw should engage the screw boss (Part #1A). Once engaged, snug down both mounting screws. Then, thread the screw covers onto the screw cover adaptors on the inside of the door.

Step 5

Install the Dummy Deadbolt

- A) Using **Figure #1 - Version A** for reference, gather together the cylinder faceplate (Part #9), the 1" mounting screw (Part #8), the dummy cylinder (Part #7), the spin ring (Part #6), the deadbolt escutcheon (Part #5), and the faceplate crimping tool (Part #10). Note that the Georgetown and Newport styles do not require or include a spin ring.

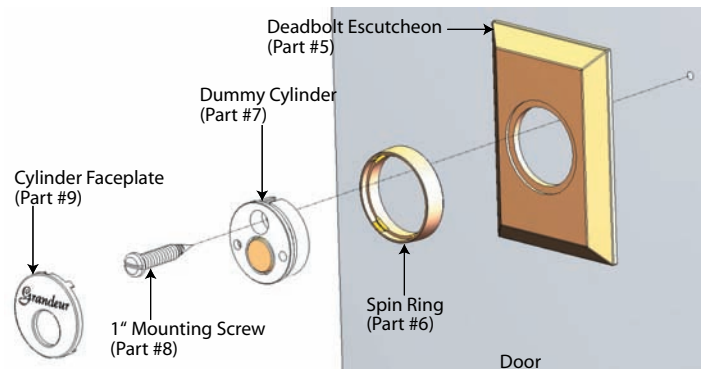
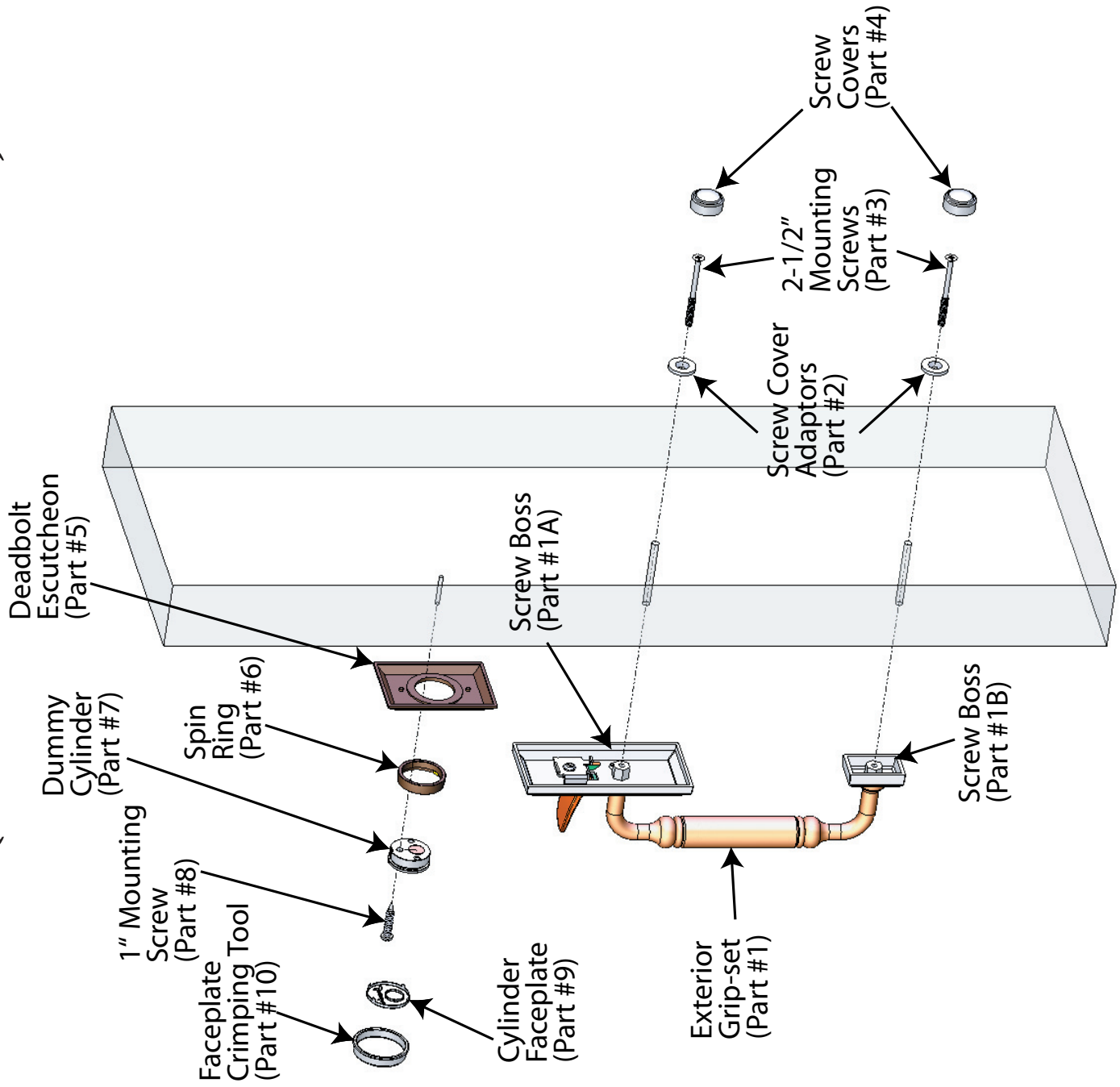

Figure #6

- B) Assemble together the deadbolt escutcheon, the spin ring (if required) and the dummy cylinder as shown in **Figure #6**. Insert the mounting screw through the top, center hole in the face of the dummy cylinder as shown in **Figure #6**.
- C) Thread the screw into the deadbolt hole, making sure that the deadbolt escutcheon remains aligned on the door. Snug down, but do not overtighten.
- D) Position the cylinder faceplate on the dummy cylinder such that the tabs align with the notches in the dummy cylinder. Once aligned, place the plastic faceplate crimping tool (Part #10) over the faceplate, making sure that the cylinder faceplate remains aligned. Firmly and evenly strike the faceplate crimping tool with a rubber mallet or hammer to permanently attach the faceplate to the dummy cylinder.

Congratulations! You are now
on your way to enriching your
life with *Grandeur!*

Figure #1 - Version A (no interior hardware)



Version B

Rosette Interior on an Un-prepped Door

Step 1

Select the position of the handleset

- A) In most cases, dummy handlesets are used next to a fully functional handleset on French (or double) doors. Always install the functional handleset first on the primary door, and then align the dummy handleset to match the functional one. Most people will choose to align two matching handlesets, so that they are positioned evenly on the two side-by-side doors. In these cases, it is best to align the lowest mounting holes on each grip as shown in **Figure #7**. Note: In some cases, dummy handlesets are used on single doors. In these cases, measure the height of another doorknob in the home. This will be the height at which the top portion of the grip is located, so that it is comfortable to use.

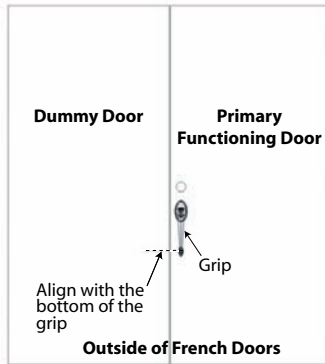

Figure #7

Step 2

Aligning the Handleset

- A) Measure the backset of the functional handleset. The backset measurement is the distance from the edge of the door to the center of where you will drill your holes. This will either be 2-3/8" or 2-3/4".
- B) On the inside of the primary door, remove the screw cover from the inside bottom of the functional handleset and take out the screw. Place a level at the height of the center of the screw hole. Once you have the level set level to the floor, mark the dummy door at this height. Then measure in the distance of your backset and mark this point where it crosses the screw hole height, see **Figure #8**. This will be referred to as the "base point".
- C) Using the base point as your reference, measure up 8-1/32" and mark a horizontal line. Measure in from the edge of the door the distance of your backset and mark where the two lines cross. This will be the center of the top grip hole.

- D) Visually review the marks to verify that they line up well with the functional handleset on the primary door as shown in **Figure #8**. Note: The base point should be aligned with the center of the bottom screw hole or screw cover. The grip hole should be aligned with a point just below the knob on the primary door and the top rosette hole will be just above the knob on the primary door. The top rosette hole should be aligned with the top rosette screw on the primary door.

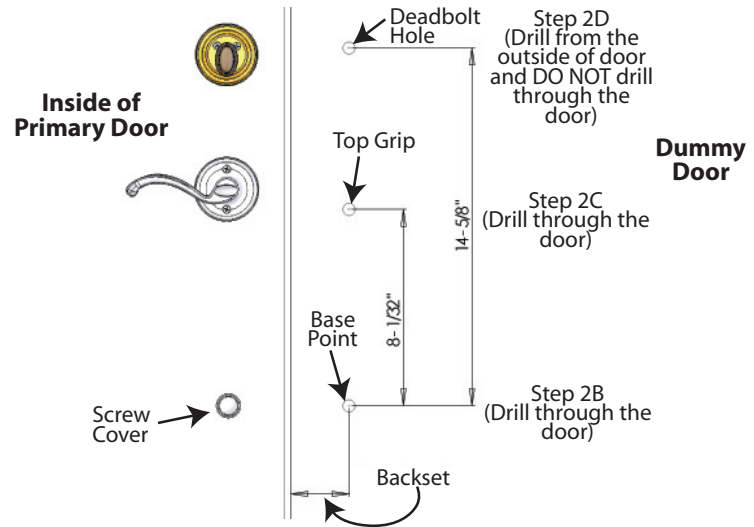

Figure #8

Step 3

Drill the Door

- A) Drill the base point hole and the top grip hole using a 7/32" bit. Drill these holes all the way through the door, being careful not to push the drill too hard, as this may result in splintering the outside of a wooden door. Always drill level and straight to minimize alignment issues.
- B) On the outside of the door, using the top grip hole that you just drilled as reference, measure up 6-5/8" and mark a horizontal line. Measure in from the edge of the door the distance of your backset and mark where the two lines cross. Note: This assumes a 5-1/2" center-to-center distance between the grip-set and deadbolt on the primary door. If the distance on the edge of your door between the latch and deadbolt is not 5-1/2" you will have to make adjustments to visually match the dummy deadbolt and the primary door deadbolt. Drill the deadbolt hole using a 7/64" drill bit, making sure NOT to drill through the door. This hole only needs to be 3/4" deep.

Step 4

Install the Grip-set

- A) Using **Figure #9** for reference, gather together the exterior grip-set (Part #1), 2-1/2" mounting screw (Part #3), screw cover adaptor (Part #2), screw cover (Part #4), 1" rosette wood screw (Part #11), 2" rosette mounting screw (Part #12) and rosette assembly (Part #13). Insert the 2-1/2" mounting screw through the screw cover adaptor as shown in **Figure #9**. Insert the mounting screw through the base point hole from the inside of the door. On the outside of the door, hold the grip-set in position and align the screw boss (Part #1B), with the mounting screw as it comes through the door. Tighten down until nearly snug.

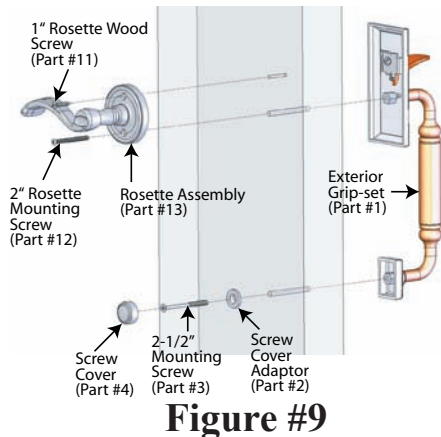

Figure #9

- B) Insert the 2" rosette mounting screw (Part #12) through the bottom screw hole from rosette assembly and into the top grip hole from the inside of the door. Align the top of the grip-set over the hole. The screw should engage the screw boss. Once engaged, align the rosette assembly for appearance and snug down both screws.
- C) Visually align the rosette assembly, so that it appears level and in line with the other door hardware on the primary door (if applicable). Using an awl or nail, mark the top rosette hole, then slightly loosen the bottom rosette mounting screw and carefully rotate the rosette assembly out of the way. Using a 7/64" drill bit, drill a hole 3/4" deep.
- D) Rotate the rosette assembly back into position. Insert a 1" rosette wood screw (Part #11) through the top rosette hole and into the hole you just drilled. Tighten down both rosette screws until snug.
- E) Thread the screw cover onto the screw cover adaptor at the base point.

Step 5

Install the Outside Half of the Dummy Deadbolt

- A) Using **Figure #10** for reference, gather together the cylinder faceplate (part #9), the 1" mounting screw (part #8), the dummy cylinder (part #7), the spin ring (part #6) and the deadbolt escutcheon (part #5). Note that the Georgetown and Newport styles do not require or include a spin ring.

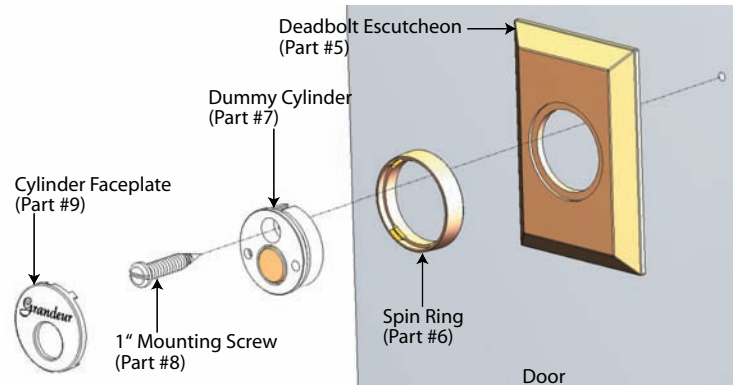

Figure #10

- B) Assemble together the deadbolt escutcheon, the spin ring (if required) and the dummy cylinder as shown in **Figure #10**. Insert the 1" mounting screw through the top, center hole in the face of the dummy cylinder as shown in **Figure #10**.
- C) Thread the 1" screw into the deadbolt hole, making sure that the deadbolt escutcheon remains aligned on the door. Snug down, but do not overtighten.
- D) Position the cylinder faceplate on the dummy cylinder such that the tabs align with the notches in the dummy cylinder. Once aligned, place the plastic faceplate crimping tool over the faceplate, making sure that the cylinder faceplate remains aligned. Firmly and evenly strike the faceplate crimping tool to permanently attach the faceplate to the dummy cylinder.

Step 6

Install the Inside Half of the Dummy Deadbolt

- A) Gather together the thumbturn assembly (Part #14) and two 1" interior wood screws (Part #17).
- B) Visually align the thumbturn assembly with the deadbolt thumbturn on the primary door. Make sure that the deadbolt is the correct distance from the edge of the door (backset of either 2-3/8" or 2-3/4"). Using an awl or nail, mark the placement of the interior wood screws through the two screw holes, making sure that the interior wood screw holes are oriented above the thumbturn on the assembly.
- C) Set the thumbturn assembly aside and drill the holes 3/4" deep, using a 7/64" drill bit.
- D) Hold the thumbturn assembly in position on the door and insert and tighten down the two interior wood screws.

Congratulations! You are now
on your way to enriching your
life with *Grandeur!*

Figure #1 - Version B (Rosette interior on un-prepped door)

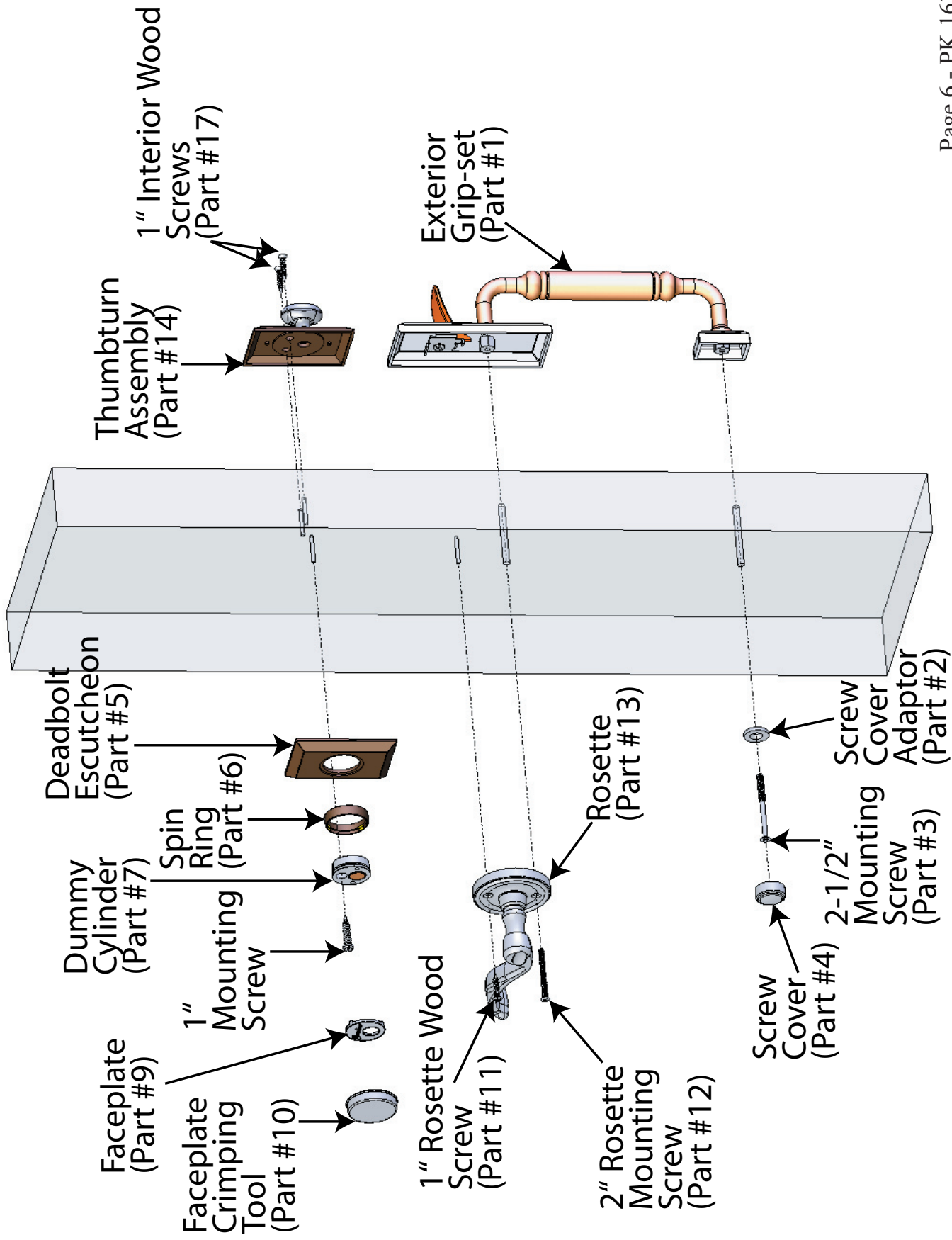

Version C

Rosette on a Prepped Door

Step 1

Prep the Door

- On the outside of the door, measure down from the bottom edge of the latch cross-bore hole 7-23/32" and lightly mark the door.
- Measure in from the edge of the door the distance of the backset and lightly mark the backset where it crosses the line made in step A. Note: The backset is the distance from the edge of the door to the center of the holes that are already drilled in your door. Backsets are either 2-3/8" or 2-3/4".
- At the intersection of the two lines, mark the point using an awl or nail.
- Drill the base hole using a 7/32" bit. Drill this hole all the way through the door, being careful not to push the drill too hard, as this may result in splintering the opposite side of a wooden door. Always drill level and straight to minimize alignment issues.

Step 2

Prep the Grip-set

- Using **Figure #11** for reference, gather together the grip-set (Part #1), the large washer, the small washer, the spacer and top grip-set boss (Part #22), the spacer and the bottom grip-set boss (Part #23).

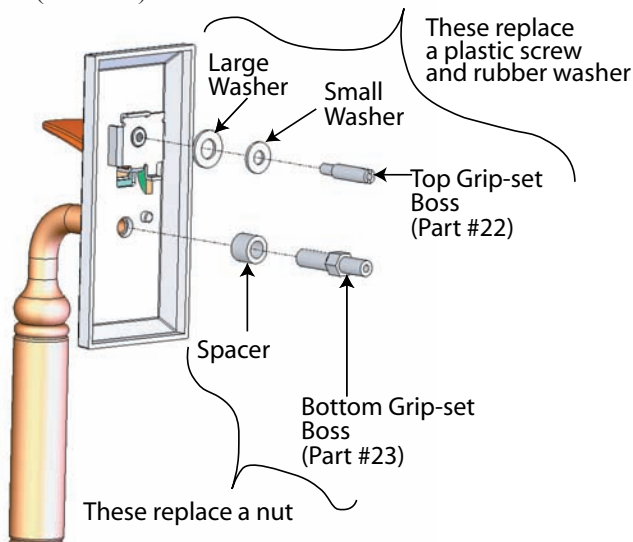

Figure #11

- Remove the plastic screw and rubber washer from the top back of the grip-set. Hold the other parts in place and install the top grip-set boss and two washers using a standard screwdriver. Do not overtighten as this may bend the boss.
- Using a wrench, carefully remove the nut on the bottom back of the grip-set. This will separate the grip from the escutcheon. Install the bottom grip-set boss and spacer using the wrench. Do not overtighten as this may bend the boss.

Step 3

Install the Bottom Half of the Dummy Handleset

- Using **Figure #12** for reference, gather together the grip-set with bosses added (Part #1), rosette (Part #13), two rosette mounting screws (Part #11), 2-1/2" mounting screw (Part #3), screw cover adaptor (Part #2) and screw cover (Part #4).

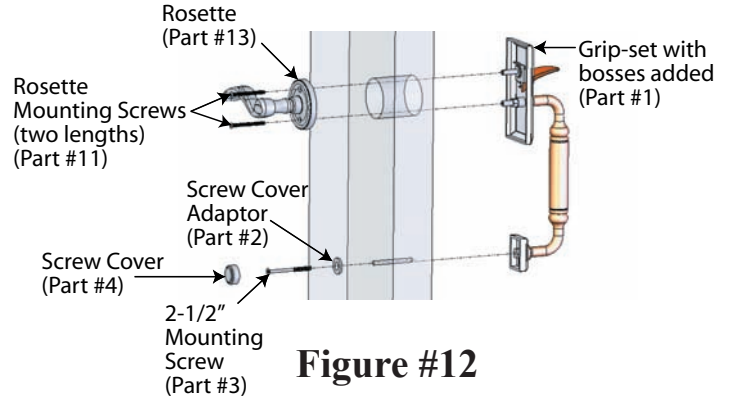

Figure #12

- Insert a rosette mounting screw through the top hole of the rosette and set aside. Two lengths are provided, start with the shorter one.
- Place the grip-set on the outside of the door, making sure it is positioned with the bosses in the latch bore.
- Insert the 2-1/2" mounting screw through the screw cover adaptor and into the base point hole from the inside of the door. On the outside of the door, hold the grip-set in position and align it with the screw as it comes through the door. Tighten down until snug. This will hold the grip-set in place on the door.
- On the inside of the door, place the rosette into position and align the top screw with the top grip-set boss. Thread in the screw until nearly snug, making sure not to scratch the door or the rosette. If the screw does not engage fully, switch to the longer rosette mounting screw.
- Insert the second rosette mounting screw into the lower rosette screw hole. Align it with the lower grip-set boss and thread on the screw.
- Align the rosette and grip-set for appearance and tighten down the screws. Do not overtighten. Thread the screw cover onto the screw cover adaptor at the base point.

Step 4

Install the Dummy Deadbolt

- Using **Figure #1** for reference, gather together the escutcheon (Part #5), the spin ring (Part #6), the dummy cylinder (Part #7), the cylinder faceplate (Part #9) and the faceplate crimping tool (Part #10).
- Assemble together the escutcheon, spin ring (Note: Not all designs include a spin ring) and dummy cylinder to make the escutcheon assembly. Make sure that the faceplate is oriented correctly. See **Figure #13**.

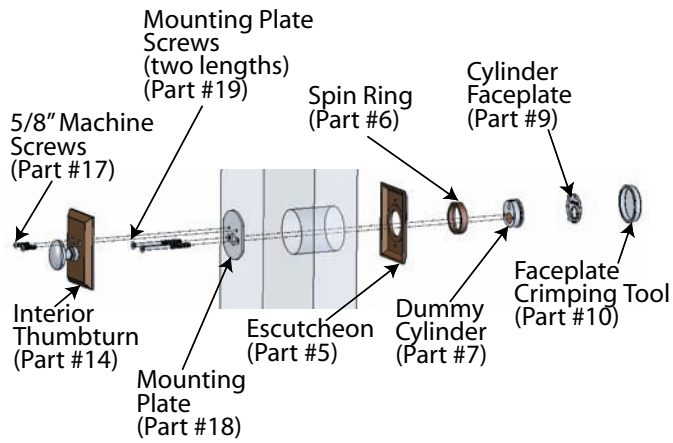

Figure #13

- C) Insert one mounting plate screw through the mounting plate and place within easy reach. Note: To accommodate different door thicknesses, there are two mounting plate screw lengths provided. Try the shortest first.
- D) On the outside of the door, place the escutcheon assembly over the deadbolt cross bore. On the inside of the door place the mounting plate and screw. Insert the screw into the corresponding hole on the back of the dummy cylinder and tighten until nearly snug. If the screw does not properly thread into the back of the dummy cylinder, try the next longer size.
- E) Insert and screw in the second mounting plate screw.
- F) Align the escutcheon assembly for appearance and snug down both mounting plate screws
- G) Place the interior thumbturn over the mounting plate. Attach using two 5/8" machine screws (Part #17).
- H) Position the cylinder faceplate on the dummy cylinder such that the tabs align with the notches in the dummy cylinder. Once aligned, place the plastic faceplate crimping tool over the faceplate, making sure that the cylinder faceplate remains aligned. Firmly and evenly strike the faceplate crimping tool with a rubber mallet or hammer to permanently attach the faceplate to the dummy cylinder.

**Congratulations! You are now
 on your way to enriching your
 life with *Grandeur!***

Figure #1 - Version C (Rosette interior on prepped door)

