

babysense™

Babysense 7

The original non-contact baby movement monitor

User Manual



US Patent
No. 5271412



Babysense 7

The original non-contact baby movement monitor

Warnings

Ensure you read this user guide before installing and using the product.

Babysense is a high quality, high sensitivity electronic device, which must be handled with care:

- Do not handle roughly, drop or throw.
- Follow the installation instruction carefully to ensure the device is installed securely and correctly.
- Babysense is not a toy. Do not allow children of any age to play with it.
- Do not put any additional baby or pet in the bed. Babysense cannot be used for two infants in one bed.
- Do not operate the unit in the presence of electromagnetic interference.
- Portable and mobile RF communications equipment may effect operation of this device.
- You must undertake the performance test daily and every time you move the monitor, change bedding or relocate crib/bed position (as set out in "Conduct this performance test daily" section)
- Do not operate vaporizer or ventilator directly towards the bed.
- To avoid possible danger from sensor cords, ensure that excess cords are pulled back under the mattress, secured with the included cable tie and are not visible or reachable.
- Install 4 new and identical size AA 1.5 volt Alkaline batteries.
- **Do not use rechargeable batteries**
- **IMPORTANT:** It is strongly advised that parents and caregivers learn how to give first aid.
- Please remove batteries if the device is not in use for a long time (more than 3 months).
- If you have any problems with this device, such as setting up, maintaining or using, please contact the manufacturer's service personnel. Also, please report to the manufacturer if any unexpected operation or events occur.
- Do not use the equipment if you notice a change in the system's performance, if the system is damaged, or if any of its components are worn or frayed.
- The equipment should not be used adjacent to or stacked with other equipment. If adjacent or stacked use is necessary, the equipment should be observed to verify normal operation in the configuration in which it is used.

Please note

Babysense monitors and alerts, but cannot prevent any type of distress. The responsibility for applying first aid rests on caretakers. The Babysense senses movements and motion only, and cannot monitor other occurrences. The purpose of the device is to alert when stopping or slowing of movement occurs.

Babysense is a unique safety and reassurance system which helps give parents peace of mind, alerting if movements stop or become irregularly slow, giving time to intervene. There are a number of cautionary steps,

SAFE SLEEPING:

- * Always lay baby to sleep on his or her back.
- * Refrain from smoking near or around baby.
- * Avoid over-heating of baby's surrounding.
- * Do not leave any objects near your baby that can cause suffocation.

Babysense 7 is a home movement monitor for infants up to one year of age, and is not to be used with high-risk infants requiring constant medical supervision. Medically trained staff such as nurses, or non-medically trained users such as parents or caregivers may use the Babysense. Babysense 7 is intended for home use.

Principal Of Operation

Babysense continually detects baby's motion and movements, and will set off a sound and visual alarm if movement stops for 20 seconds or if the monitor detects less than 10 micro-movements per minute. The system's non-touch sensor pads under the mattress monitor baby's movement without restraining him.

Installation

WARNING: Please note that the green power light is not an indicator for movements of the baby. It only indicates that the Babysense monitor is ON. When movement is sensed, the green movement indicator light flashes.

1. For inserting the batteries, remove the battery cover by inserting a wide flat screw driver into the opening recess (see illustration 7). Insert, **in accordance with the markings**, 4 new and identical size AA 1.5 volt Alkaline batteries and close cover.

Note: Please dispose of used batteries in accordance with local waste regulations.

2. Place control unit holder on the base of the crib or bed and in between two bars as shown in illustration 1.

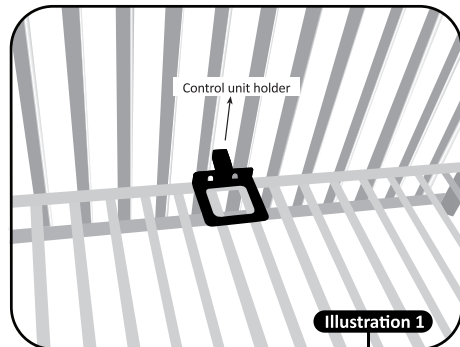

3. Sensor pad installation:

- When using for infant not yet able to crawl, place one sensor pad as shown in illustration 2. Make sure the sensor is placed underneath baby's location in crib.
- When baby begins to crawl, and is able to move onto areas not "covered" by a single sensor pad, attach the second sensor and place the two sensors as shown in illustration 2.

PLEASE NOTE: The sensors shall be placed with the marking "THIS SIDE UP" facing upfront.

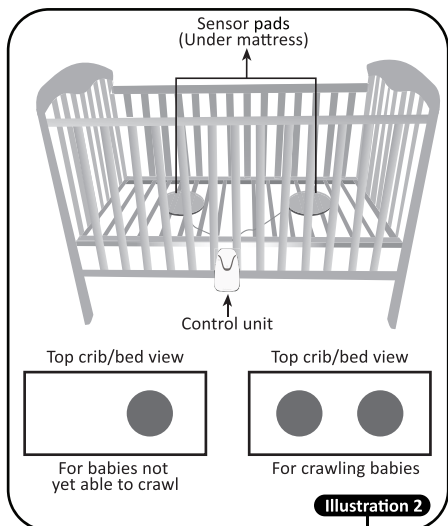

4. When using a crib/bed equipped with spring base, place extra wooden board (plywood) under each sensor pad, as shown in illustration 3. The recommended size of the board is at least 17" x 11" and 1/2" thick.

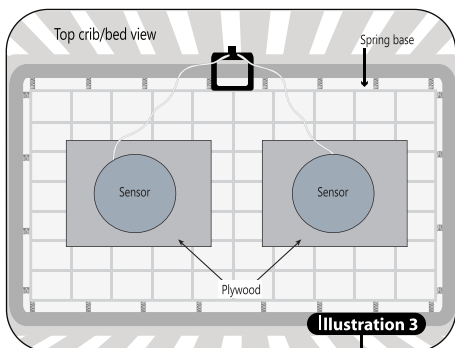

5. Pass the cord(s) of the sensor pad(s) through special openings in the holder (see illustration 4 and 5).

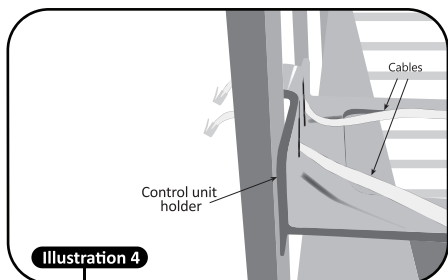

6. Attach end(s) of the cord(s) to the outlets marked "SENSOR" on the back of control unit (see illustration 6 and 7). When using one sensor pad, attach to any "SENSOR" outlet.

PLEASE NOTE: Do not attach any cable to the blocked socket, marked "DO NOT USE".

7. Should the design of the crib / bed not allow proper installation with the control unit holder, please use the optional hanging hook (see illustration 6) and hang the control unit from the bottom edge of the crib.

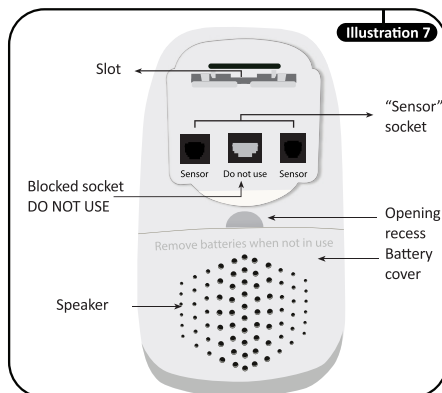
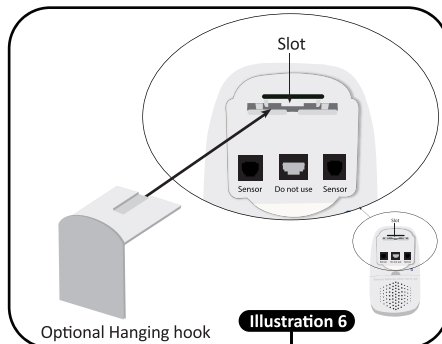
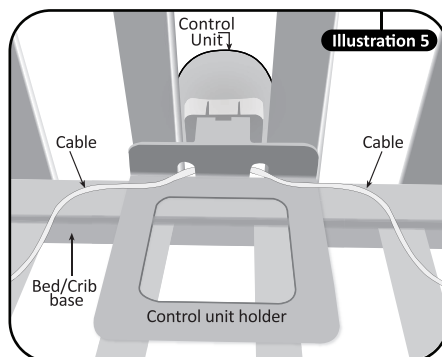

8. Press control unit holder or hanging hook firmly into slot in back of control unit (see illustration 6 and 7).
9. Place mattress firmly on top of sensor pads. If the mattress cannot be in contact with the sensor pads, or if the bed base is soft, padded or contains springs, place extra plywood on the bed base, place the sensor pads on the plywood and place the mattress firmly on top.

IMPORTANT: To avoid possible danger from sensor cords, ensure that excess cords are pulled back under the mattress, secured with the included cable tie and are not visible or reachable.

Layout of control unit

See illustration 8 for layout of control unit featuring:

- On/Off button.
- Green movement indicator light.
- Green power light.
- Acoustic and visual red alarm light.
- Low battery red warning light.

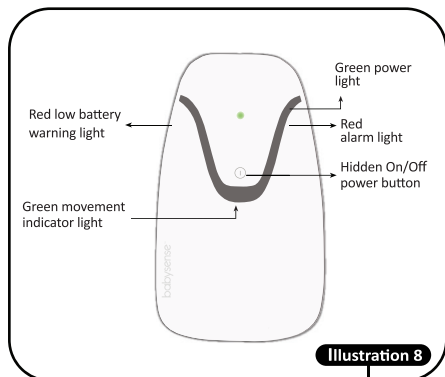

Operation

Babysense is ready for operation and use once the installation is completed. To operate, follow the below instructions:

- Place your baby in crib/bed.
- Turn control unit on by pressing On / Off button.
- Make sure red control lights switch on briefly.
- When any movement is sensed, the green movement indicator light flashes.
- Acoustic and visual red alarm light are activated if the baby's movement stops or slows significantly.
- If red low-battery warning light flashes, replace all batteries as soon as possible. If in addition clicking is heard, all batteries must be replaced immediately.
- Turn off by pressing On / Off button before taking your baby out of crib / bed.

Testing Operation

Babysense is a highly sensitive device, which monitors a baby's motion and movements through the mattress during sleep. There are two main causes of malfunction - technical malfunctions and malfunctions due to environmental factors.

Technical malfunction

In order to minimize technical problems, follow installation and operation instructions carefully.

Environmentally caused malfunction

Due to the high sensitivity of Babysense, fans, wind, air conditioning, and so forth can influence it. Such environmental effects could be picked up by the sensors on a similar level to that of slight movements, thus preventing or delaying alarm activation. If the Babysense is concurrently used with other devices, it is required to conduct the daily performance test (below) under an environment identical to the actual situation and while all concurrently used devices are "ON". Under such conditions, it is required to verify that the acoustic and visual alarms of Babysense are activated.

Conduct this performance test daily

Do not conduct performance test by picking up baby out of bed and waiting for the alarm to sound

- The performance test should be conducted while baby is not in bed.
- Turn device on and take two steps away from bed.
- Ensure that alarm goes off within 20 seconds (due to absence of movement).
- The alarm may sound with or without preliminary ticking.
- Check that alarm can be heard in all locations throughout the home or place of care.
- In case the alarm does not sound within 20 seconds refer to troubleshooting section.
- Performance test must be conducted daily and every time you move the monitor, change bedding or relocate crib/bed position.

False alarms

Isolated cases of false alarms are possible. Check if caused by faulty connection of the sensor pad(s) to the control unit, connection of only one sensor pad when baby can move off the immediate area or failure of the sensor pads to be directly against the mattress. In case of false alarms, kindly refer to troubleshooting section. If the problem cannot be solved, please contact manufacturer's service personnel.

Symptom	Possible Cause	Solution
Lights on Control Unit don't illuminate when turned ON	<ul style="list-style-type: none"> Batteries are not inserted correctly or may be flat. 	<ul style="list-style-type: none"> Check batteries are inserted in the Control Unit observing the correct polarity. Control Unit requires 4 X AA 1.5V Alkaline batteries (not supplied).
Low battery voltage warning (red light) on the Control Unit	<ul style="list-style-type: none"> Batteries low. 	<ul style="list-style-type: none"> If red low-battery warning light flashes, replace all batteries as soon as possible. If in addition clicking is heard, all batteries must be replaced immediately.
False alarm up to 1/2 minute from activating	<ul style="list-style-type: none"> Sensor pad is out of order. Cable is connected to monitor's blocked socket. 	<ul style="list-style-type: none"> Connect one sensor pad and lay the baby on the bed for 1 minute. If the alarm does not activate, the sensor pad is in order. If the alarm activates, disconnect and place the sensor pad aside. Connect the other sensor pad and repeat steps above. Do not connect any cables to the blocked socket (only to "SENSOR" socket).
False alarm after 1/2 minute from activating	<ul style="list-style-type: none"> The mattress is not touching the sensor pads. 	<ul style="list-style-type: none"> Make sure that the mattress and the sensor pads are touching.
	<ul style="list-style-type: none"> The mattress is raised (there is an object near the sensor pads). 	<ul style="list-style-type: none"> Make sure that there are no objects next to the sensor pads.
	<ul style="list-style-type: none"> Placing two sensors next to each other (or using one sensor) when the baby is of crawling age or using two sensor pads far apart from each other when baby is young and is not crawling yet. 	<ul style="list-style-type: none"> Connect according to instructions. It is important to use only one sensor pad when the baby is young and is not crawling yet. It is important to make sure that two sensor pads are used when the baby is moving around. Make sure the sensor pads are placed underneath baby's location in bed / crib.
	<ul style="list-style-type: none"> The mattress does not enable transfer of baby movements (a rigid mattress, a mattress with springs or a mattress with air pockets). Soft or spring bed / crib base. 	<ul style="list-style-type: none"> Place extra plywood under the sensor pad so that the sensor pad and the mattress will be tightly pressed together.
Delayed alarms while taking the baby out of the bed	<ul style="list-style-type: none"> Performance test is not correct. 	<ul style="list-style-type: none"> Do not conduct performance test by taking the baby out of bed and waiting for the alarm to sound. Kindly conduct performance test according to guidance in "Conduct this performance test daily" section
The alarm does not go off within 20 seconds when performing the correct performance test	<ul style="list-style-type: none"> Environmental influences detected by the sensor pads, such as wind, fan, air conditioner, baby mobile toy, vibrations. 	<ul style="list-style-type: none"> Perform a test which will detect the source of the movement that the device detects. For example, sources of wind such as: air conditioner, an open window or a fan; movements of a baby mobile toy (which can vibrate even if it's not turned on) or walking around the bed area. Solutions: Eliminate sources of wind, remove the mobile toy etc. After neutralizing all environmental influences, perform the test again. If even after neutralizing all of the environmental influences, the alarm does not go off within 20 seconds, perform the following: <ul style="list-style-type: none"> 1. Test the control unit: <ul style="list-style-type: none"> - Disconnect all cables from the control unit. - Turn control unit on (with no cables attached). - Alarm activation within 20 seconds indicates that the unit is OK – proceed to the next steps. - If the alarm does not sound within 20 seconds, stop using the device and contact your local distributor. 2. Test each sensor pad separately: <ul style="list-style-type: none"> - Connect one sensor pad to either "SENSOR" socket on control unit. - Turn control unit on and take two steps back from the bed. - Alarm activation within 20 seconds indicates that the sensor is OK – perform the above procedures with the second sensor pad. - If the alarm does not sound within 20 seconds, place the sensor pad aside. Note: If one of the sensor pads is NOT OK, continue using the product with only the one correctly functioning sensor. If one or both sensors are NOT OK, contact your local distributor for further guidance. 3. Test two sensor pads together: <ul style="list-style-type: none"> - If both sensors were OK in Step 2, connect both sensors to "SENSOR" sockets on the control unit. - Turn control unit on and take two steps back from the bed. - Alarm activation within 20 seconds indicates that the sensors are OK - continue using the product. - If the alarm does not sound within 20 seconds, connect one sensor only and continue using the product. Contact your local distributor for further guidance.

Technical Specifications

- Powered by 4 size AA, 1.5 volt batteries.
Power consumption approx. 2mA.
- **Do not use rechargeable batteries**
- Battery life approx. 6 months using alkaline batteries.
- Alarm volume typically 85dB SPL at distance of one meter.
- Size of sensor pad is \approx 216 mm.
- Babysense has a service life of 3 years from the date of purchase.

Conditions of operation and storage

Conditions of operation are as follows:

Temperature: 0 °C to 40 °C

Relative humidity: 20 %RH to 80 %RH

Atmospheric pressure: up to 55kPa

Conditions of storage between uses are as follows:

Temperature: 0 °C to 40 °C

Relative humidity: 5 %RH to 95 %RH

Atmospheric pressure: up to 55kPa

Contents

- Control Unit
 - Control Unit Holder
 - Optional Hanging Hook
 - 2 Sensor pads
 - 2 Cable Ties (tied around the sensor cables when supplied)
 - User guide
- Please note that the batteries are not supplied.

Cleaning and Disposal

As necessary, the device (sensor pads and control unit) may be wiped with a damp cloth.

The device and accessories are to be disposed of according to local regulations after their service lives. Alternatively, they can be returned to the dealer or the manufacturer for recycling or proper disposal.

Caring for your babysense

Babysense requires no special treatment beyond replacing batteries when the battery indicator light goes on. The sensor pads and control unit may be wiped with a damp cloth. Batteries should be removed and the device stored in a dry shaded place when not in use.

It is recommended to replace sensor pads two years after their first use. Use only Babysense sensor pads.

Made by Hisense Ltd., an ISO 9001 and ISO 13485 certified company.
27 Shaked St. Hevel Modiin
Industrial Park, 7319900 ISRAEL
Tel +(972) 3.956.66.04 www.hisense.co.il
www.babysensemonitors.com



LIMITED WARRANTY

THIS LIMITED WARRANTY CONTAINS IMPORTANT INFORMATION ABOUT YOUR RIGHTS AND OBLIGATIONS, AS WELL AS LIMITATIONS AND EXCLUSIONS THAT MAY APPLY TO YOU.

This product will be free from defects in material and workmanship for a period of 1 year from the date of purchase following the original retail purchase, (the "Warranty Period").

If the Product fails to conform to this Limited Warranty during the Warranty Period, Baby Monitor Direct will at its sole discretion, either (a) repair or replace any defective product at no cost, or (b) accept the return of the product and refund the money actually paid by the original purchaser for the product. Any Product that has either been repaired or replaced under this Limited Warranty will be covered by the terms of this Limited Warranty for the remaining Warranty Period.

This Limited Warranty does not apply to product that has been damaged as a result of improper maintenance or other misuse. This Limited Warranty is automatically void if the purchaser repairs or modifies the product in any way. Baby Monitor Direct will not be liable in any way for any damage, including incidental or consequential damage, caused by such repaired or modified product.

WARRANTY CLAIMS

If you wish to make a claim under this warranty, please contact Babysense Monitor Direct customer support at: support@babysensemonitors.com

DISCLAIMER OF WARRANTIES

EXCEPT AS STATED ABOVE, AND TO THE MAXIMUM EXTENT PERMITTED BY APPLICABLE LAW, HISENSE DISCLAIMS ALL EXPRESS, IMPLIED, AND STATUTORY WARRANTIES AND CONDITIONS WITH RESPECT TO THE PRODUCT. TO THE MAXIMUM EXTENT PERMITTED BY APPLICABLE LAW, HISENSE ALSO LIMITS THE DURATION OF ANY APPLICABLE IMPLIED WARRANTIES OR CONDITIONS TO THE DURATION OF THIS LIMITED WARRANTY.

Baby Monitor Direct LLC
2093A Philadelphia Pike
Suite 177
Claymont, DE 19703

For additional information, please visit our website or call the telephone number below:

Website: www.babysensemonitors.com
Tel. number (833) 568-2229

Other phenomena, symptoms, malfunctions – if you cannot find and solve the problem, please contact us at support@babysensemonitors.com