



LS-291

PRODUCT MANUAL



Dear User,

Thank you for your Luxury Spas purchase. To enable you to use this product safely and effectively, please read this operation manual carefully before use. Questions? Please contact us at 866.220.7405.

Before Use

1. Check to make sure the drain cap located in the lower corner of the spa base is tight and secure before filling the spa with water. You may attach an optional drain hose to the drain connection to drain water away from the spa. (Fig.1)
2. Ensure that the spa is connected to the correct electrical power. The electrical power requirements are listed under the Technical Specification section of this manual.
3. Before turning on the water pump, remove the filter from the skimmer basket to remove the plastic protective wrapping and place it back in the skimmer basket. Make sure the water level is a minimum of 1 inch over the top jets. Do not turn on water pump, heat pump or air bubble pump without water.
4. People with medical conditions such as hypertension or heart disease should not use this product. Minors should only use the spa under adult supervision only. Consult a physician if you are unsure whether the spa is safe to use.
5. Adjust the water temperature to your desired temperature setting using the heater button on the user keypad. The included user keypad manual provides instructions on how to operate the spa controls.
6. Make sure that slip resistant steps are used to enter and exit the spa being careful to avoid slipping.

Technical Specs:

MODEL: LS-291

SIZE: 77"x 52"x 31"

WATTAGE: 4650 TOTAL WATTS

VOLTAGE: 240V, 30 AMPS

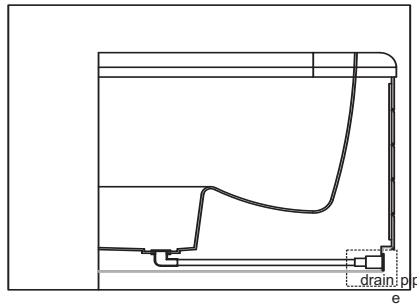

Cleaning and Maintenance

1. Test your water chemical balance 2–4 times per month. Adjust the water balance with the appropriate hot tub chemicals. Use the recommendations listed in the included Cleaning and Maintenance guide to ensure the sanitizer levels. Keep a water test log track your test results and make notes on adjustments.
2. Clean the spa filter every 2 weeks and replace it annually. The spa filter is located under the skimmer basket. Remove the skimmer cover to locate the filter to clean or replace it. The water filter cartridge should be replaced when flow is noticeably reduced. We recommend cleaning the spa filter every 2 weeks. To clean the filter, remove any large debris from the filter. Use a water hose to spray any smaller debris from the filter. Soak the filter overnight in a 5-gallon bucket full of water and a spa filter cleaner that can be purchased at your local pool and spa supply store.
3. Replace your spa filter approximately every 12 months. Change the spa filter every 12 months or every 15 cleanings. Keep track of your spa filter's age and/or cleaning cycles. Keep the spa clean by draining it and refilling it every 3–4 months. While the hot tub is drained, conduct a full cleaning of all surfaces, the waterline and plumbing. Do NOT use any household cleaning products or soaps. Choose a quality hot tub specific cleaning product to keep out phosphates, nitrates and other contaminants that can negatively affect water quality. For accumulated dirt and debris, vacuum seats and floors with a small vacuum made specifically for spas and hot tubs. Floating debris can be removed with a simple skimmer net.
4. Air out the spa cover twice per week. To increase the longevity of your spa cover, remove it every couple of weeks, flip it upside down, and allow it to breathe. Cleaning and condition your spa cover with a vinyl spa cover cleaner. Using a spa cover cleaner can quickly remove airborne oils, dirt, tree sap and pollen. After it's clean, use a cover conditioner to replenish the vinyl plasticizers that keep your vinyl spa cover soft, strong and looking great.
5. Add fill water to your spa. The water level in the spa should be in the middle of the skimmer intake or a little higher. You don't want it too high, and you never want to overflow the spa, so keep a close eye on the water level while. Do not operate the spa without the proper water level or it will damage the spa pump.

If you have additional questions on maintaining your new Luxury Spas hot tub, please contact us at 866.220.7405.

Troubleshooting

Problems	Reasons	Maintenances
Spa will not turn on.	<ol style="list-style-type: none"> 1.No power to the spa. 2.Keypad control wire is not connected 	<ol style="list-style-type: none"> 1.Check the breaker powering the spa to make sure it is in the ON position. 2.Check to make sure the spa has power at the terminal box box. Check the keypad wire to make sure its connected.
Jetsts are not working.	<ol style="list-style-type: none"> 1.Pump button on keypad is off. . 2.The impeller of the water pump doesn't rotate. 3.Water pump is broken which is caused by running pump without water. 	<ol style="list-style-type: none"> 1. Turn on the pump from keypad. 2. Remove intake hose from pump and remove any garbage which is inside the pump. 3. Install a new water pump
The intensity of massage jets cannot be adjusted	<ol style="list-style-type: none"> 1.Water pump's suction is restricted. 2.Air adjustment valve is not turned on. 3. Jets or nozzles are blocked 	<ol style="list-style-type: none"> 1. Check the water pump intake filters to make they are clear of any blockages. 2. Rotate the air adjustment valve. 3. Check to ensure jets are not blocked.
Water leaks from the pipes.	<ol style="list-style-type: none"> 1.Seal ring is broken 2.PVC escutcheon ring is not tight. 3.Broken seal at PVC joint. 4. PVC water pipe is broken 	<ol style="list-style-type: none"> 1.Change seal ring. 2.Tighten escutcheon ring. 3. Reseal joint with PVC glue. 4. Replace damaged water pipe.
Control panel doesn't work	<ol style="list-style-type: none"> 1.Keypad control wire not connect to power source. 2.Keypad power button is not working. 	<ol style="list-style-type: none"> 1.Re-connect the keypad control wire to the control box. 2.Replace the control panel. 3.Replace the control box.
No lighting	<ol style="list-style-type: none"> 1.The bulb is broken 2.Lighting power line is disconnected. 3.Control panel is broken 	<ol style="list-style-type: none"> 1.Change the LED bulb. 2. Re-connect the lighting circuit. 3.Change control panel
Radio is off	<ol style="list-style-type: none"> 1.Speaker is broken. 2.Spa is not equipped with a radio. 3.Cntrol panel is broken 	<ol style="list-style-type: none"> 1.Replace the speaker 2.Replace the control panel

Construction Sketch

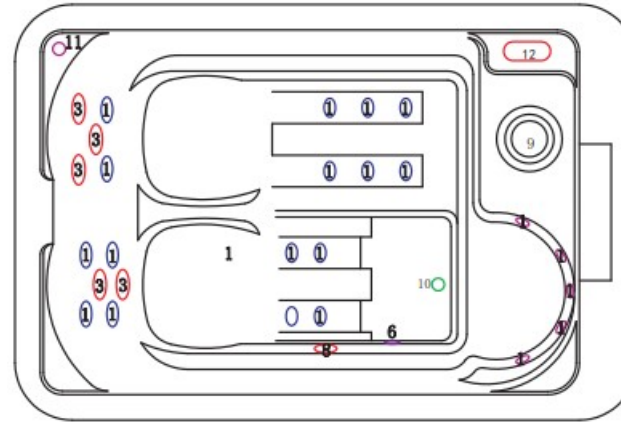

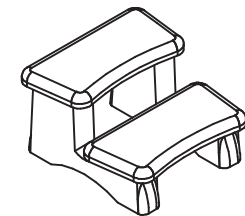
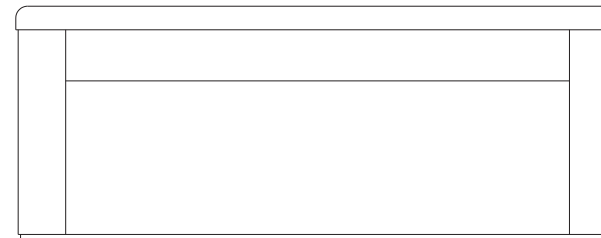
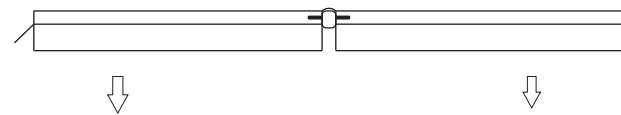

1	1" Jet
3	3.5" Jet
6	Water suction
8	Lamp
9	Filter
10	Drain
11	Air adjustor
12	Control panel

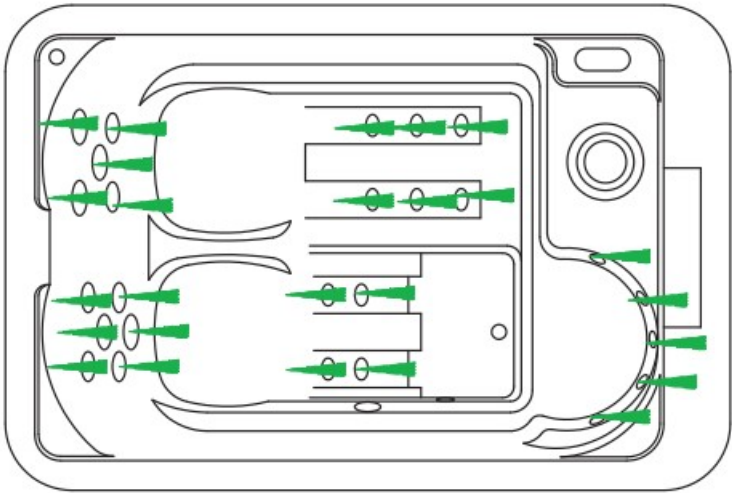

Stair and cover are extra option

Water Controls



When system is in standard mode, pressing the  button will turn the dual-speed pump on at high speed to power the jets. Press again and the pump will work at low speed like a filter pump, and all jets will spray water smoothly.

Control box Dual speed pump Heater

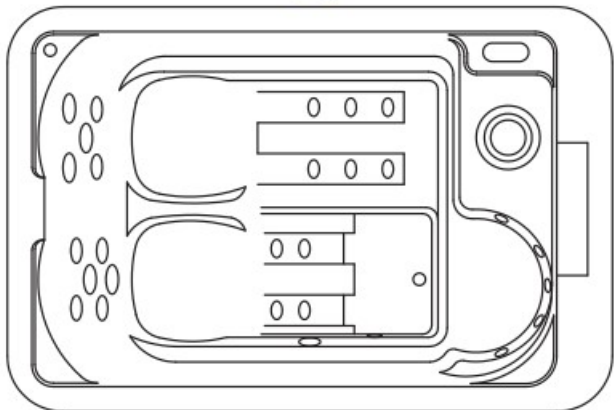

Removing the Spa Skirt

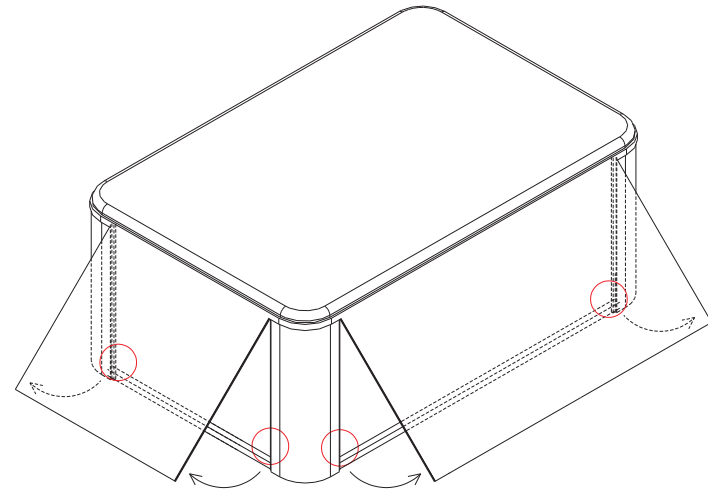

The spa skirt can be removed by taking the screws out at the bottom of each corner panel. Then pull up and out on the skirt to remove it.

Filter Cleaning

