

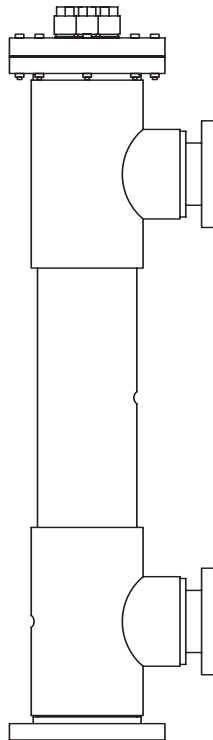

# BIOSHIELD®

## COMMERCIAL VERTICAL UV STERILIZER



# INSTALLATION AND USER'S GUIDE

IMPORTANT SAFETY INSTRUCTIONS  
*READ AND FOLLOW ALL INSTRUCTIONS*  
SAVE THESE INSTRUCTIONS



## CUSTOMER SERVICE / TECHNICAL SUPPORT

If you have questions about ordering Pentair Commercial Aquatics™ replacement parts and products, please use the following contact information:

### Customer Service

8 AM to 7 PM — Eastern and Pacific Times

Phone: (800) 831-7133

Fax: (919) 566-8920

### Web site

Visit [www.pentaircommercial.com](http://www.pentaircommercial.com)

## TABLE OF CONTENTS

<b>Section 1: Introduction</b> .....	<b>1</b>	<b>Section 8: Maintenance</b> .....	<b>23</b>
General Information	1	Routine Inspection	23
Glossary	1	UV Lamp Replacement	23
<b>Section 2: Health and Safety Precautions</b> .....	<b>2</b>	UV Lamp Removal	23
Safety Symbols	2	UV Lamp Recycling	24
Safety Instructions	2	UV Lamp Installation	24
Hazardous Situations and Appropriate Actions	3	Quartz Sleeve Inspection/Replacement/Cleaning	24
<b>Section 3: Installation</b> .....	<b>4</b>	Quartz Sleeve Removal	24
Pre-Installation Inspection	4	Quartz Sleeve Cleaning	26
UV Vessel Installation	5	Quartz Sleeve Installation	26
Quartz Sleeve Installation	6	UV Vessel Cleaning	26
Power Supply Installation	8	UV Vessel Disassembly	28
Temperature and UV Intensity Sensor		Cooling Fan and Filter Mat Replacement/Cleaning	30
Installation	9	Cooling Fan Filter Removal	30
<b>Section 4: Mandatory Leak Test</b> .....	<b>10</b>	Cooling Fan Filter Cleaning	30
<b>Section 5: UV Lamp Installation</b> .....	<b>11</b>	Cooling Fan Filter Installation	30
UV Lamp Installation	11	<b>Section 9: Replacement Parts</b> .....	<b>31</b>
Lamp Field Safety Cover Installation	13	Quartz Sleeve and UV Lamp Matrix	31
<b>Section 6: Commissioning</b> .....	<b>14</b>	Illustrated Parts View	32
Start-Up	14	Replacement Parts List	32
<b>Section 7: Operation</b> .....	<b>15</b>	<b>Section 10: Troubleshooting</b> .....	<b>33</b>
PLC Power Supply Operation	15	<b>Section 11: System Specifications</b> .....	<b>34</b>
PLC Control Descriptions	16	Dimensional Drawings	34
		Dimensional Data	35
		Electrical Data and Flow Rates	35
		Sizing Rates	36
		<b>Section 12: Product Warranty</b> .....	<b>37</b>

# INTRODUCTION

## General Information

In this manual you will find user information for your Bioshield® Commercial Vertical UV Sterilizer. It is an important document for safety guidance, installation, operation and maintenance. Read and understand all sections of this Manual before starting the installation or operation of this UV system. Strictly follow this Manual and all safety notes, they are for your own safety.

Custom-made, project specific modifications of the UV system and/or additionally integrated components may result in non-conformity of the system and void the warranty.

The information contained in this manual represents our most recent experiences and technical knowledge. This information does not hold a legally binding promise of certain characteristics or suitability for a specific application. The user of the UV system will be required to perform his/her own verifications and safety measures.

Pentair Water Pool and Spa, Inc. (Pentair) accepts no responsibility for any problems arising from incorrect installation, lack of routine maintenance as specified in this manual or modifications of the UV system.

**Important Note:** This unit has demonstrated an ability to provide three log inactivation of *Enterococcus Faecium* [ATCC #6569] and *Pseudomonas Aeruginosa* [ATCC #27313]. This unit has not demonstrated an ability to provide three log kill or inactivation of *Cryptosporidium*. This product is designed for supplementary disinfection and is intended for use with appropriate residual levels of EPA registered disinfecting chemicals. Specific residual levels of EPA registered disinfecting chemicals may be required by the regulatory agency having authority.

## Glossary

Term	Description
Disinfection	The inactivation of harmful microorganisms
End of Useful Lamp Life	Recommended time to replace a UV lamp
External On/Off Switch	Manually operated switch to isolate the UV System
Fouling	Build up of scale in the vessel, sensor or quartz sleeve
Isolation Valve	Manually or automatically operated valve(s) used to isolate the UV vessel.
J/m <sup>2</sup>	Joule per square meter A Unit of UV Dose 10 J/m <sup>2</sup> = 1 mJ/cm <sup>2</sup> = 1,000 uWs/cm <sup>2</sup>
Minimum UV Intensity	Required value at end of lamp life (alarm threshold value) to maintain the minimum UV dose at a given flow rate and a given UV transmission.
nm	Nanometer – Light wavelength measurement
Personal Protective Equipment	Hard Hat, Safety Glasses, Rubber Gloves, Safety Shoes
Power Supply Enclosure	NEMA Type-12 cabinet housing electrical hardware, instruments and PLC control/monitor
Text Display	Screen used to view PLC Controller/Monitor data
UV-C	Specific UV area of the light spectrum (200 – 280 nm)
UV Dose	Indicates amount of UV light
UV Intensity	Indicates the strength of UV light
UV Output	Amount of UV light emitted from a UV lamp
UVT	Ultraviolet Transmissibility
UV Sensor	Sensing-probe installed on the UV vessel to measure UV intensity-UV light wavelength 254nm
UV System	Entire UV System that includes the Power Supply Enclosure and UV Vessel
UV Vessel	Wet portion of the UV System that generally consists of: quartz sleeve(s), UV lamp(s), stainless steel or polymer vessel, and valve(s)

# HEALTH AND SAFETY PRECAUTIONS

## Safety Symbols



Caution



High Voltage



Warning



Chemical (Corrosive)



Protective Eye wear (UV Light)



Sharp Object







Recycle



## Safety Instructions

### IMPORTANT SAFETY INSTRUCTIONS PLEASE READ PRIOR TO INSTALLATION AND OPERATION

Strictly follow the instructions within this manual to ensure the health and safety of both, yourself and the UV system. The installation, operation and maintenance of the Bioshield® Commercial Vertical UV Sterilizer can only be carried out after reading and understanding the information contained in this manual.

The installation of the UV system must be carried out in accordance with local regulations and codes.

	<b>WARNING:</b> Water and electricity can be a dangerous combination. Help us ensure your safety. READ AND FOLLOW ALL SAFETY INSTRUCTIONS.
	<b>DANGER:</b> UV lamps and quartz sleeves are fragile and if broken and handled incorrectly may cause serious injury.
	<b>IMPORTANT:</b> READ AND OBSERVE ALL IMPORTANT NOTICES AND LABELS ON THE UNIT. <b>REMOVAL OF PRODUCT LABEL WILL VOID WARRANTY!</b>
	<b>IMPORTANT:</b> For your safety the quartz sleeve and/or the UV lamp in this product may have been broken or damaged during shipping. It is <b>ESSENTIAL</b> that the unit be <b>CAREFULLY INSPECTED BEFORE CONNECTING TO ELECTRIC POWER.</b>
	<b>WARNING:</b> DO NOT exceed 150 PSI during operation.
	<b>DANGER:</b> To avoid possible electric shock special care should be taken since water is employed in the use of the UV System. For each of the following situations, do not attempt repairs yourself. Call Pentair customer service department at (800) 831-7133.
	<b>DANGER:</b> If the unit falls into the water, <b>DO NOT REACH FOR IT!</b> First unplug it and then retrieve it. If the internal electrical components of the unit get wet, unplug the unit immediately.
	<b>DANGER:</b> If the unit shows any sign of water leakage, immediately unplug it from the power source.
	<b>DANGER:</b> DO NOT operate this unit if it has a damaged cord or plug, if it is malfunctioning, or if it has been dropped or damaged in any manner.

	<b>IMPORTANT:</b> Close supervision is necessary when any appliance is used by or near children, this UV system is no exception.
	<b>IMPORTANT:</b> Always unplug the unit from the electrical outlet when it's not in use, before servicing, cleaning or removing parts. Never yank the cord to pull the plug from the outlet. Grasp the plug and pull to disconnect.
	<b>IMPORTANT:</b> Each UV system is designed for a specific water-pressure. DO NOT use the UV system for any application other than its intended use. The use of attachments not recommended or sold by Pentair may cause unsafe conditions and possibly void any warranty.
	<b>IMPORTANT:</b> Only (3) three wire grounded cables suitable for outdoor use should be used to connect this unit. If joining cables for outdoor use, a suitable watertight cable connector must be used. If an extension cord is necessary, a cord with a proper rating should be used. A cord rated for less ampere or watts than the appliance's rating may overheat. Care should be taken to arrange the cord so that it will not be tripped over or pulled. If in doubt consult a qualified electrician.
	<b>IMPORTANT:</b> Only operate the UV system when it is properly maintained and in good working order.
	<b>IMPORTANT:</b> DO NOT modify the UV system without authorization from the manufacturer.
	<b>DANGER:</b> BLUE-LIGHT HAZARD Ultraviolet light will cause serious damage to your eyes and skin! DO NOT handle or stare at an operating UV lamp. UV lamps become hot during operation, DO NOT handle them during operation.

## Hazardous Situations & Appropriate Actions

Situation	Location	Hazard	Actions
Lamp or Quartz Sleeve Removal	UV Vessel	Burn	Isolate UV system from water source, shutdown system using external On/Off switch and lock-out disconnect from input power source.
Broken Quartz Sleeves/ UV Lamps	UV Vessel	Sharp Object	Handle quartz sleeves and UV lamps with extreme care, wear clean cotton gloves.
UV Lamp Replacement	UV Vessel	Blue-Light Hazard	DO NOT operate UV lamps outside the UV vessel, wear protective eye wear against ultraviolet light.
Drain UV Vessel	UV Vessel	Pressure	Isolate UV system from water source and shutdown system using external On/Off switch and lock-out/disconnect from input power source. Open valves carefully to relieve pressure and drain the UV Vessel.
Vessel Cleaning	UV Vessel	Corrosive/ Chemical	Isolate the UV vessel and secure against unauthorized operation. Wear appropriate protection equipment. No smoking or food allowed.
Electrical Work	UV System	Electrical Shock	Shutdown system using the UV system's external On/Off switch and lock-out/disconnect from input power source. All electrical work should be carried out by authorized and qualified personnel only.

# INSTALLATION

---

## Pre-Installation Inspection

### Purpose

To familiarize the installer/operator with the Bioshield® Commercial Vertical UV Disinfection Sterilizer's components, to assure proper delivery of all the system's components and to inspect each component for shipping damages.

### Frequency

To be conducted prior to installation.

### Parts and Required Equipment

- Adjustable Wrench or 1.5" Socket
- Box Cutter
- Hammer/Nail Remover
- Flashlight

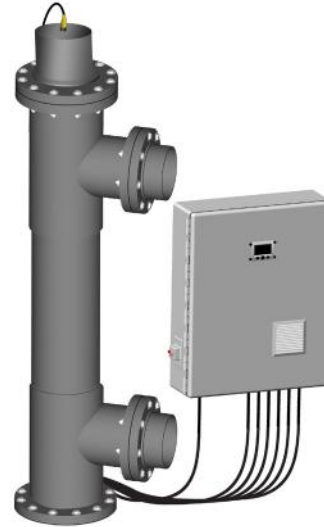

During pre-installation there is a general risk due to load.



Quartz Sleeves and UV Lamps are fragile and potentially dangerous if broken. Handle with care.

---

## Procedure

**Note:** Vessel diameters up to 8" are shipped with their quartz sleeves assembled. Vessel diameters 10" and larger are shipped with their quartz sleeves packaged separately.

**Note:** UV Lamp(s) are shipped in a separate package either inside the vessel crate or separately.

1. Unpack and inspect vessel for shipping damage. A box cutter or hammer/nail remover may be needed to unpack the UV System.
2. Conduct an internal, visual inspection of models shipped with their quartz sleeves assembled. A flashlight will help with the internal inspection.

### The UV System consists of:

- Quartz Sleeve Module (QSM) Faceplate (assembled on Vessel)
- QSM Faceplate Gasket (assembled on Vessel)
- UV Intensity Sensor
- Temperature Sensor
- Quartz Sleeve Retainer Nut (one for each quartz sleeve)
- Quartz Sleeve Gasket (one for each quartz sleeve retainer nut)
- Drain Valve Assembly
- Quartz Sleeve (one for each UV Lamp)
- UV Lamp(s)
- Vessel
- Bolt(s) (assembled on Vessel)
- Nut(s) (assembled on Vessel)
- Washer(s) (assembled on Vessel)
- 4-Pin Connector(s) (attached to lamp cables)
- Lamp Field Safety Cover and Cable

## UV Vessel Installation

### Purpose

Proper installation of the UV Vessel achieves expected results and ensures safe operation.

### Frequency

Required with new construction, retro-fit or replacement of outdated equipment.

### Parts and Required Equipment

- Socket Wrenches
- Adjustable Wrenches
- Set of Slotted and Phillips Head Screwdrivers
- Lifting Equipment with Slings
- Vessel Mounting Brackets
- Required Isolation Valves
- Plumbing Components
- Personal Safety Equipment



General risk due to load.



General risk due to pressurized piping or UV Vessel.



Quartz Sleeves are fragile and potentially dangerous if broken. Handle with care.

### Procedure

**Important:** The installation of the UV system must be carried out in accordance with local regulations and codes.

1. Install the UV system after the mechanical filtration. This eliminates debris from entering the vessel and diminishing the unit's effectiveness, as well as potentially damaging the quartz sleeves and UV lamps.
2. Install inlet and outlet isolation valves (to be supplied by others).
3. Install UV vessel mounting brackets if required (to be supplied by others).

**Note:** A clearance is required for lamp and quartz sleeve removal. See column "B" of the Dimensional Data table on page 35 to determine the recommended clearance for your particular unit.

### Horizontal Installation

Horizontal installation requires the vessel outlet port to face upwards, allowing trapped air to escape. If installed on a "by-pass filter loop" or isolated using valves, an automatic air bleed system is required. **Failure to remove trapped air can result in rupture or heat damage to the vessel.**

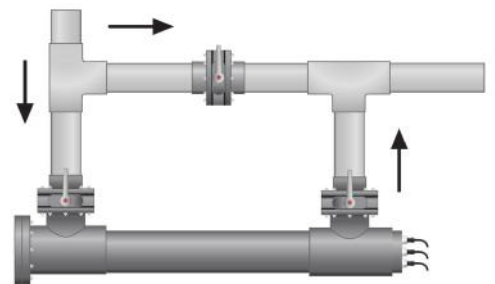

### Vertical Installation

Vertical installation requires the bottom port to be used as the vessel's inlet and the port closest to the electrical end to be used as the outlet; allowing trapped air to escape. If installed on a "by-pass filter loop" or isolated using valves, an automatic air bleed system is required. **Failure to remove trapped air can result in rupture or heat damage to the vessel.**

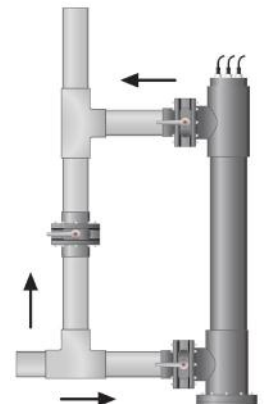

- 
4. Models equipped with inlet/outlet union fittings are ready for piping installation. Models equipped with inlet/outlet raised flanges require mating pipe flanges (not included). Depending on port type ordered, further fabrication may be required by the installer.
- 
5. Isolation Valves are necessary for vessel removal and chemical cleaning procedure. It is recommended to install the isolation valves in conjunction with a separate set of, matching size & type, water port connections to the inlet/outlet ports of the vessel. Adding the “double connection” will enable the UV sterilizer to be removed from the filtration loop without shutting the total filtration system down. If this installation arrangement is not possible, install the unit in a way that chemical cleaners or freshwater rinse can be drained completely from the vessel without contaminating the process water.
- 
6. The UV System (models w/ diameters of 10” and larger) may have been shipped without their quartz sleeves installed in the vessel, please install now. See **Page 6** for details.
- 
7. The vessel is equipped with a 0.5” female threaded drain port for installation of the Drain Valve Assembly. Use thread tape on the threads when installing the drain valve assembly.
- 
8. The vessel is equipped with various sensor ports (UV Intensity and Water Temperature Sensors), additional sensor ports may be included depending on the model or options purchased with the UV System. All sensor ports will be labeled on the vessel based on their respective function. Use thread tape on the threads to create a reliable seal with all sensors. Sensors must be threaded into their respective vessel ports prior to connection to the power supply enclosure to avoid sensor damage from cable twisting.
- 

## Quartz Sleeve Installation

### Purpose

To thermally protect the UV lamp and isolate it from water.

### Frequency

Quartz Sleeve(s) are installed after being inspected/cleaned or damaged. Water quality conditions may warrant more frequent inspection/cleaning. Fouled quartz sleeves absorb UV light and therefore may reduce the UV intensity. Replace broken quartz sleeve(s).

### Parts and Required Equipment

- Quartz Sleeve(s)
- Quartz Sleeve Retaining Nut Gasket
- Adjustable Wrench
- Cotton or Silicon Gloves
- Personal Safety Equipment
- White Retaining Nut Tightening Tool (provided with the UV system)



General risk due to electricity.



General risk due to pressurized piping or UV Vessel.



Quartz Sleeves are fragile and potentially dangerous if broken. Handle with care.

---

### Procedure

**Note:** Use clean cotton or silicon gloves when handling the quartz sleeve(s). Skin oils absorb ultraviolet light and reduce UV intensity.

- 
1. Apply water (wet) or a small amount of water soluble lubricant to the domed-end of the quartz sleeve. Lubricating will aid in inserting the domed-end of the quartz sleeve into the vessel’s internal quartz sleeve coupler.
-



2. Carefully slide the quartz sleeve(s) into the Quartz Sleeve Faceplate's "Quartz Sleeve Module" (QSM) allowing approximately 12" of the quartz sleeve to remain outside the UV vessel.



3. With 12" of the quartz sleeve exposed outside the vessel, carefully place the Quartz Sleeve Rubber Gasket Seal onto the open-end of the quartz sleeve.  
Apply water or a small amount of water soluble lubricant onto the end of the quartz sleeve, this will act as a lubricant and will allow you to easily slide the Rubber Gasket onto the quartz sleeve.  
The rubber gasket should be flush with the end of the quartz sleeve.



4. As you push the quartz sleeve into the vessel (through the Quartz Sleeve Module) elevate the domed-end of the quartz sleeve by gently pushing down on the open-end approximately 1/2". This will help guide the domed-end of the quartz sleeve into its correct Internal Quartz Sleeve Coupler "Port".

5. Finish sliding the remainder of the quartz sleeve into the vessel until the gasket makes contact with the Quartz Sleeve Module.  
As you thread and tighten the Quartz Sleeve Retaining Nut onto the Quartz Sleeve Module the Quartz Sleeve Retaining Nut's internal lip will automatically set the quartz sleeve in its proper position.

6. Using the white retaining nut tightening tool included with the UV system, tighten the Quartz Sleeve Retaining Nut until snug (5 ft. • lb.). Over-tightening can break the Quartz Sleeve Module on the faceplate or the quartz sleeve inside the UV vessel.

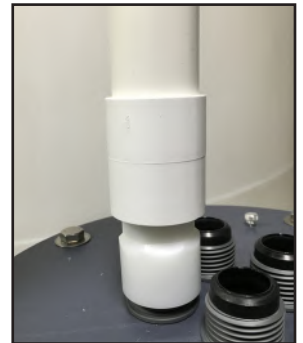

7. The quartz sleeve is now properly assembled, you are now ready to perform a Leak Test See **Page 10**.

## Power Supply Installation

### Purpose

Power Supply Enclosure is part of the complete Bioshield® Commercial Vertical UV Sterilizer.

### Frequency

Required with new construction, retro-fit or replacement of outdated equipment.

### Parts and Required Equipment

- Set of Slot and Phillips Head Screwdrivers
- Adjustable Wrench
- Pliers
- Wall Struts or Braces
- Supplied Enclosure Mounting Hardware
- Personal Safety Equipment



General risk due to suspended load.



General risk due to electricity.



General risk due to pressurized piping or UV Vessel.

---

### Procedure

1. Use the supplied enclosure mounting feet if the Power Supply Enclosure is going to be mounted on a wall.
2. Mount the Power Supply Enclosure close to the UV Vessel so that the lamp cables reach between the Power Supply Enclosure and the UV Vessel. The power supply lamp cables are approximately 10 - 20' long to provide an adequate routing length from the power supply enclosure to the UV vessel. Keep in mind that the temperature & UV sensors have approximately 12' long cables, so the power supply should be placed within this length constraint to avoid the additional requirement of sensor extension cables.
3. The Power Supply Enclosure should be mounted so that the controls are visible to the operator. The location used for mounting the Power Supply Enclosure should be as dry and cool as possible.
4. The Power Supply Enclosure should be located in a place that provides sufficient weather protection, in the case of outdoor installation. Sufficient space near the cooling fan's intake and exhaust must be provided.
5. The Power Supply Enclosure must be supplied with the correct operating voltage (120/230 VAC). Electrical requirement information is located on the Power Supply Enclosure labeling and can be found on **Page 35** (Electrical Data) of this manual. Failure to supply the UV System with the correct operating voltage can damage the ballasts and other electrical hardware. Use only a well-ground electrical circuit.
6. The UV System is equipped with an equipment-grounding conductor and a grounding plug. The grounding plug must be installed and grounded in accordance with all local codes and ordinances. Improper connection of the equipment-grounding conductor can result in electrocution. Check with a qualified electrician or service personnel if you question whether the equipment is properly grounded.
7. Input power to the Power Supply Enclosure is switched on and off using the enclosure's External On/Off switch or optional Remote On/Off control.



**Note:** All UV control enclosures that utilize our PLC controls should be mounted with considerations to other devices that emit, or are suspected of emitting, any EMI & RFI noise and that any sensors used in conjunction with our PLC controls should use industry standard procedures to avoid EMI & RFI noise issues.

## Temperature & UV Intensity Sensor Installation

### Purpose

To instruct the operator how to properly install the Temperature and UV Intensity Sensors.

### Frequency

Required with new installation or when servicing the unit during general maintenance.

### Parts and Required Equipment

- Flare-Nut Wrenches
- Thread Tape
- Personal Safety Equipment



General risk due to electricity.



General risk due to pressurized piping and UV vessel.



General risk due to suspended load.

### Procedure

1. Install the Temperature and UV Intensity Sensors into their respective port locations as labeled on the vessel using Thread Tape to properly seal the sensor threads in the vessel. To avoid possible sensor damage from cable twisting, **DO NOT** connect the sensor cables to the power supply until after they are installed into the vessel. Leave the sensor cables coiled up close to the sensor during the installation process to allow the cable to rotate as the sensor is being screwed into the vessel. If the cable becomes twisted during the installation process, untwist it before proceeding.



2. Use a flare-nut wrench to carefully tighten the UV sensor and temperature sensor. These components are made of soft polytetrafluoroethylene (PTFE) and can be easily damaged. Leave the sensor cables coiled up close to the sensor during the installation.
3. Once the sensors have been installed into the vessel you can attach cables to their respective connection points located on the bottom of the Power Supply Enclosure.

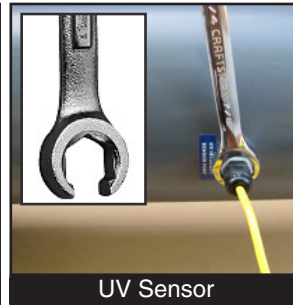

**WARNING:** *Sensor-cables should be isolated from other electrical devices, preventing electrical interference. UV intensity sensor-cables must also be separated from UV lamp cables to minimize electrical interference.*

**Note:** The sensor cables are approximately 12' long, if you find that you require a greater length you can purchase 12' cable extensions using the following part numbers:

- Optional UV Intensity Sensor Extension Cable: #20214-EXTCABLE
- Optional Temperature Sensor Extension Cable: #20217-EXTCABLE
- Not Shown = Lamp Field Safety Extension Cable: #20252-EXTCABLE



**Note:** The Temperature Sensor must be installed in the vessel with its water tight connector properly connected to its respective port located on the power supply enclosure. *A Temperature Sensor Cable connection interruption will automatically shut down the system.*

# MANDATORY LEAK TEST

---

## Mandatory Leak Test

### Purpose

The Mandatory Leak Test identifies a potential quartz sleeve assembly seal failure. During normal UV system operation, a quartz sleeve assembly failure can result in extensive damage to the UV lamp, quartz sleeve and ballast.

### Frequency

The Mandatory Leak Test must be performed after a quartz sleeve/retaining nut gasket inspection/replacement. Quartz Sleeve inspection/retaining nut gasket replacement must be carried out annually, at minimum.

### Parts and Required Equipment

- Paper Towels
- Personal Safety Equipment



General risk due



UV Lamps are fragile and potentially dangerous if broken. Handle with care.

### Procedure

**Important:** Failure to perform a leak test could lead to unsafe conditions and may void your product's warranties.

1. With the quartz sleeves installed inside the UV vessel, before installation of the UV lamps, perform a leak test as explained below. For quartz sleeve removal see **Page 24**. For installation see **Page 6**.



2. Thread all sensors into their respective ports on the UV vessel.

3. Place rolled-up paper towels into the Quartz Sleeve Retaining Nuts. During the leak test, the paper towels may absorb moisture. The presence of any moisture identifies that a quartz sleeve seal failure (leak) has occurred.



4. Inspect all piping connections to the UV Vessel and confirm that valves are in their correct position prior to start-up.
5. With satisfactory piping and valve inspection, operate the UV system. Allow water to flow through the UV Vessel for no less than fifteen minutes.
6. After fifteen minutes of flowing water through the UV vessel, remove the paper towel from each Quartz Sleeve Retaining Nut and inspect closely for ANY sign of moisture. If leaks are detected, shut the system down and re-install any quartz sleeve with an inadequate seal. For quartz sleeve removal/installation See **Pages 24 and 6**.
7. If no leaks were detected you are now ready to install the UV Lamp(s). See **Page 11**.

# UV LAMP INSTALLATION

## UV Lamp Installation

### Purpose

To instruct the operator how to properly install the UV lamp(s).

### Frequency

Lamp installation in new unit or lamp replacement change-out (after every 12,000 hours of cumulative operation).

### Parts and Required Equipment

- UV Lamp(s)
- Wire Cutters
- Adjustable Wrenches
- Cotton or Silicon Gloves
- Personal Safety Equipment



General risk due to electricity.



UV Lamps are fragile and potentially dangerous if broken. Handle with care.

### Procedure

**Important:** Before installing the UV Lamp(s) a **MANDATORY LEAK TEST** must be performed. See **Page 10**.

**Note:** Use clean cotton or silicon gloves when handling the UV lamp(s). Skin oils absorb ultraviolet light and reduce UV intensity. Skin oils may also lead to premature lamp failure.

1. Remove the white polytetrafluoroethylene (PTFE) "wire keeping" rings from the UV lamp by carefully cutting it off with wire cutters.

**Note:** Be careful not to cut the lamp wires!



2. Gently slide the UV Lamp into the Quartz Sleeve Retaining Nut leaving 6" of the UV lamp exposed.

**IMPORTANT:** INSTALL LAMPS WITH AMALGAM SPOT IN DOWN POSITION!



**Note:** Lower wattage amalgam lamps contain a single mass of amalgam while higher wattage amalgam lamps contain multiple masses of amalgam.

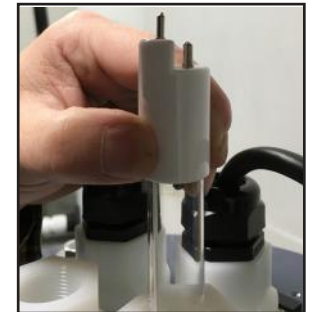

**Note:** When installing the lamp into the quartz sleeve position that is monitored by the UV Intensity Sensor, it is important to make sure the lamp wires that run the length of the lamp are not facing the sensor. See diagram, at right for the proper lamp placement.

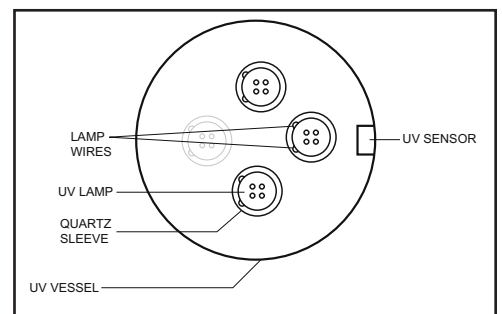

**Note:** Each Lamp cable (1) is equipped with a Water Tight Connector (2). This cable adapter is made up of three components: Nut (3), Rubber Gasket (4) and Male-Threaded Body (5).

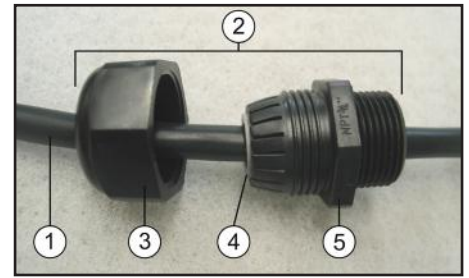

- Loosen (not remove) the lamp Water Tight Connector nut (3) to release tension on the lamp cable allowing the cable to slide freely through the adapter. This will allow the male-threaded body (5) portion of the lamp Water Tight Connector to be threaded into the white quartz sleeve retaining nut without twisting the lamp cable (after lamp installation).

- With the UV lamp installed inside the quartz sleeve and six inches exposed, attached the lamp cable's stepped 4-Pin Connector on to the four pins of the UV lamp.

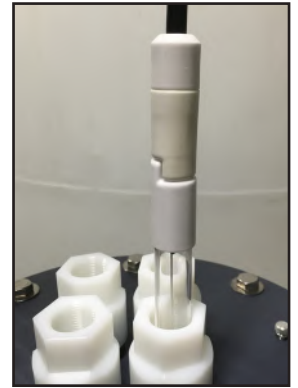

- With the lamp cable/lamp connection complete gently slide the remainder of the lamp w/ cable through the Quartz Sleeve Retaining Nut and into the quartz sleeve. With the lamp now inside the quartz sleeve, gently continue to push the lamp (w/ connected lamp cable) into the quartz sleeve until it stops, then pull out 1/2" of the lamp cable. This will position the lamp properly inside the quartz sleeve avoiding heat damage to the Quartz Sleeve Module Faceplate and Quartz Sleeve Module.

- With the UV lamp in its correct position inside the quartz sleeve, thread the water tight connector into the Quartz Sleeve Retaining Nut.



- With the "black" Water Tight Connector threaded into the Quartz Sleeve Retaining Nut, tighten the Cable Adapter Nut (3) to create a watertight seal on the lamp's cable. Take care not to bend or damage the Water Tight Connector's "gasket prongs" during this process.



- The UV lamp is now properly installed.



## Lamp Field Safety Cover Installation

### Purpose

To instruct the operator how to properly install the Lamp Field Safety Cover.

### Frequency

Required anytime the lamp field is accessed.

### Parts and Required Equipment

- Lamp Field Safety Cover
- Pliers
- Personal Safety Equipment



General risk due to electricity.

### Procedure

1. With the UV lamps and lamp cables installed hand loosen the four Safety Cover Retaining Screws from the QSM Faceplate so they have approximately 3/8" of clearance between the head of the screw and the QSM Faceplate.



2. The Lamp Field Safety Cover uses a twist-lock attachment method that can only be installed one way. Take the cover assembly with the cable slot facing downward and align the four slotted keyways on the cover's flange face with the retaining screws on the QSM Faceplate. Then place the cover over the screws and turn counterclockwise to engage the retaining screws.



3. Once the cover is in place, tighten the four Retaining Screws down until the cover is snugly held in place.

4. With the cover installed on the vessel, connect the Lamp Field Safety Cover cable that is attached to the power supply to the connector that is located on the end of the Safety Cover.



**Note:** The Lamp Field Safety Cover must be installed onto the vessel with its respective cable, located on the Power Supply Enclosure, properly connected to its respective port on the Safety Cover. Removing the Lamp Field Safety Cover or the cable connection will automatically shut off the UV system's lamp field and generate an alarm signal.

# COMMISSIONING

---

## Start-Up

### Purpose

This section contains the necessary steps required to prepare the Bioshield® Commercial Vertical UV Sterilizer for proper operation.

### Frequency

Required with new construction, retro-fit or replacement of outdated equipment.

### Parts and Required Equipment

- Personal Safety Equipment



General risk due to pressurized piping and UV Vessel!



General risk due to electricity!



Hydraulic shock (water hammer) may occur as a result of improper use of valve(s) or trapped air inside the vessel. Hydraulic shock and trapped air can damage the vessel.



Trapped air or no-flow situations may damage the vessel and/or the UV lamps due to overheating.

---

### Procedure

1. Confirm that all personnel operating this UV system have thoroughly reviewed these instructions prior to operating.
2. Remove all dirt/debris from power supply enclosure, vessel and installation area resulting from installation activities.
3. Inspect all plumbing connections and immediate plumbing network to ensure safe start-up.
4. Inspect the vessel's Quartz Sleeve Module Faceplate to ensure proper assembly.
5. Inspect quartz sleeve assemblies (Quartz Sleeve Retaining Nuts) confirming that they are tight.
6. Inspect Power Supply Enclosure, confirm that it has been mounted properly and input power is in accordance with local ordinances and codes.
7. Inspect all sensors ensuring that the probes are properly installed in the vessel and Water Tight Connectors are properly connected to their respective Power Supply Enclosure ports.
8. Verify that a successful Leak Test has been completed. See **Page 10** for instructions.



## PLC (Programmable Logic Control) Power Supply Operation

The operation of the Bioshield® Commercial Vertical UV Sterilizer may only be carried out by authorized personnel. The personnel responsible for the operation of this system must read and understand this Section, Section 2 (Health & Safety Precautions), and strictly comply with all relevant rules for accident prevention and local health and safety regulations.

Check all relevant safety measures before you switch on the UV system.

### PLC Power Supply Enclosure

#### Operating Modes

Generally, the UV system is operated in “LOCAL” mode. An optional, discrete input circuit is provided to allow for either “LOCAL/REMOTE” or “LOCAL” mode. If this option has been ordered there are two terminal blocks (brown) located inside the Power Supply Enclosure. The UV system is supplied with both the brown terminals jumped together as the default “ON” setting. To operate the UV system in the “REMOTE” mode, the “Factory-Installed Jumper” must be removed. Both the brown terminals need to be wired to an external switch (not included) capable of handling 120/230-volt AC @ 1-amp.

#### Switches

The UV system Power Supply Enclosure is equipped with an External “Main Power” ON/OFF Switch.

With the Main Power ON/OFF Switch in the “On” position, power is supplied to the PLC Controller/Monitor, and the UV lamps.

With the Main Power ON/OFF Switch in the “Off” position, power is cut-off from the entire UV system.

**Note:** The Main Power Switch must be in the “On” position if the optional Remote On/Off feature is being used.



### PLC Power Enclosure

1. PLC Power Enclosure
2. Liquid Crystal Display Screen
3. Touch Pad Control
4. External On/Off Switch
5. Main Power Cable
6. Temperature Sensor
7. UV Intensity Sensor
8. Lamp Field Safety Cover Cable
9. Lamp/Power Cables

The Text Display shows the current operating status of the UV system that includes the following parameters:

- Lamp Operating Status
- Lamp Operating Hours
- UV Intensity (UV%)
- Voltage Range
- Temperature

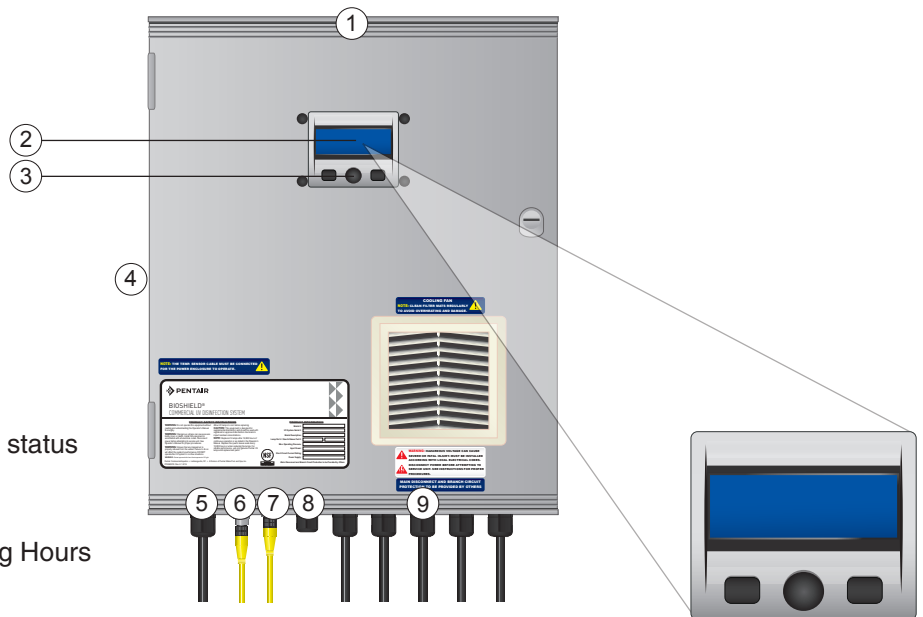

## PLC Control Descriptions

### Incoming AC Voltage Monitor

The Incoming AC Voltage Monitor monitors the input voltage to the UV system. If the value goes outside the acceptable threshold an alarm will be activated. For 120 VAC the threshold parameter is 95 – 140 VAC, for 230 VAC the threshold parameter is 210 – 260 VAC. Your unit's input voltage parameter is identified on the power supply enclosure and vessel label.

### Total Operating Hours Meter

The Total Operating Hours Meter measures in increments of one for each hour the unit is in operation. The hour meter may be reset by the operator using the appropriate SETUP Text Display. The hour meter will roll over at 65,536 hours if not reset prior to reaching this number.

### Lamp Status & Lamp Life Monitor

The Lamp Status & Lamp Life Monitor scans all active lamp inputs from 1 to 13 depending on the UV system's number of lamps. If the PLC detects an inactive lamp an alarm will be activated and the ALARM Text Display will identify which lamp is malfunctioning. The alarm may be reset but will continue to activate every twenty-four (24) hours until the lamp is replaced and the SETUP individual lamp reset is completed.

Each lamp is equipped with an individual hour meter, stored in EEPROM for data retention on power removal. At the end of each hour when the "Total Lamp Hour Meter" is incremented, all active lamps will have their individual hours monitored. Each individual lamp's hours will also be monitored for End of Lamp Life (12,000 hours) and a 72 hour recurring alarm will also be set.

### Power Supply Enclosure Temperature Monitor

The Power Supply Temperature Monitor uses a temperature sensor mounted inside the UV system's Power Supply Enclosure that monitors the enclosure's internal temperature. The temperature monitor is used to protect the UV system's electronics from overheating, a condition that could damage the unit. The enclosure's factory-set temperature threshold is 140° F. If the enclosure's internal temperature reaches 140° F the PLC controller will shutdown the lamp field and activate an alarm. The PLC controller must be powered off to reset the system and to restore lamp field operation.

### UV Vessel Water Temperature Monitor

The Water Temperature Monitor uses a sensor located on the UV vessel that monitors its internal water temperature. The UV Vessel Water Temperature Monitor is used to protect the vessel from no or low-flow conditions that may allow the lamp field to overheat causing damage to the UV vessel. The UV Vessel Water Temperature Monitor's factory-set threshold is 120° F and if reached, will cause the PLC to shut down the lamp field and activate an alarm. The PLC controller must be powered off to reset the system and to restore lamp field operation.

Additionally, if the water temperature sensor cable is interrupted/disconnected the entire UV system will shutdown and activate an alarm. The PLC Controller must be powered off to reset the system and to restore lamp field operation.

### UV Intensity Sensor

A UV Intensity Sensor is provided to monitor the quality of the UV energy that is being produced inside the unit's vessel. The PLC monitoring system displays the UV intensity as a function of percent (0%-100%), this UV intensity measurement is a relative power measurement of the UV energy inside the vessel and not an absolute measurement of UV dose because UV dose is a function of flow, the transmissibility of the water being treated, and the total UV power being applied to the flow path inside the UV vessel. The relative UV intensity (power) must be calibrated in order for the intensity measurement/reading to have any useful meaning. This calibration process is done once the system has been in service for 100 hours, the calibration screen will show a value representing percentage of UV. A button on the screen will allow setting of the 100% reading.

### Lamp Field Safety Cover

On all NSF-50 certified units there is a safety cap that covers the lamp's electrical cables that terminate into the unit's quartz sleeves. This safety cover must be installed into the vessel with its respective cable properly connected to its respective port located on the power supply enclosure. Removing the Lamp Field Safety Cover or a cable connection interruption will automatically shut off the UV system's lamp field and generate an alarm signal.

## Operator Text Display

The PLC Text Display is used to present information to the operator as well as serving as a command interface. The microprocessor performs various functions that include intercepting operator commands and updating displayed data. In addition, the software verifies voltage, lamp operation and saves current hours to EEPROM, etc.

### Function Keys

Command initiation is performed using the “Function Keys” labeled: Position 1, Position 2 and Position 3.

The “Function Keys” functions are as follows:

- Position 1 = Left
- Position 2 = Enter
- Position 3 = Right

Position 1 & 2 (pressed simultaneously) = “Big Left”  
 Position 2 & 3 (pressed simultaneously) = “Big Right”

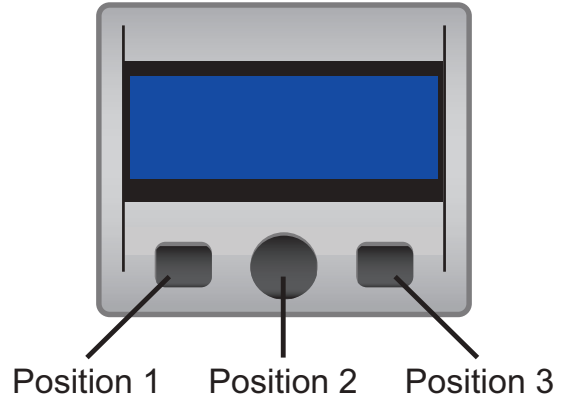

When using a function key, press and hold down until the desired action occurs. The function key must be released when selecting another key. For example: when pressing the “Enter” function key to move to the SETUP menu, Press and hold “Enter” until the text display begins to change, then let go.

### Text Display Contrast Adjustment

Your location will determine the required brightness of the Text Display. Inside the enclosure, on the back of the Text Display, on the printed circuit board, you will find an adjustment potentiometer. Carefully, use a screw driver to adjust display brightness. See image to the right.

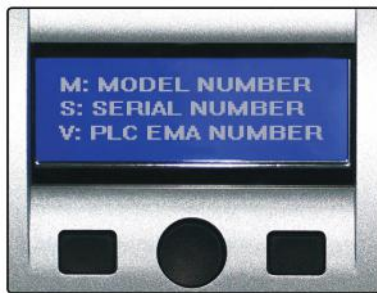
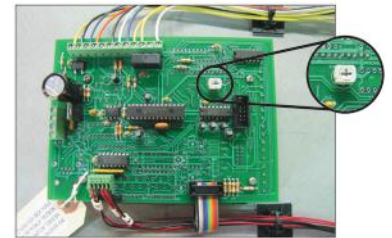

### Initialize

With the External Power Switch turned “ON”, the text display will be active for a few seconds while background system checks are made. Your unit’s model number, serial number, and PLC number will display before the main screen loads.



### MAIN UV System Text Display

The "MAIN UV System Text Display" will appear after initialization. On this screen you will see: Total System Operating Hours, Input Voltage, and UV Intensity. Total Hours may be reset and the UV scaling adjusted via the "SETUP" menu. High and Low Input Voltage (95 – 140 VAC or 210 – 260 VAC depending on the specific unit's control voltage requirements) are preset at the factory and may not be changed.

Press "ENTER" to move to the "SETUP" screen or "RIGHT" to move to the "STATUS" menu.



### STATUS Menu Text Display

Four lines of text will appear on the STATUS Menu Text Display. Use the "Right" key to advance the selection arrow (">") through the options of the STATUS Menu. Press the "Enter" key to select the desired option. Use the "Left" key to return to the "MAIN UV System Text Display".

After selecting the desired STATUS Menu option, a brief description will appear on the Text Display. Press the "Left" key to return to the STATUS MENU. Failing to press any "Function Keys" within a couple minutes will automatically revert the Text Display back to the MAIN UV System Screen.



### STATUS Menu Text Display Options

#### Lamp Status

Displays the current On/Off status of lamps 1 through X. 0 = OFF, 1 = ON. For example, a "four lamp" UV system's lamps are identified on the bottom of the screen in ascending order from right > left. The display example shown here indicates all lamps are in operation, except for lamp 3.



#### Lamp Hours

Displays the current "total" operating hours of each lamp, six per screen. Each lamp's status is checked once an hour and "Total" operating hours are incremented by a factor of one. Here, all four lamps show one hour of operation.

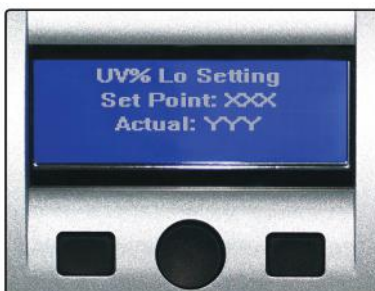

#### UV% Lo Setting

Displays the active UV low set-point as well as the actual UV % intensity. XXX shown here is an operator editable UV% parameter accessible through the SETUP screens. YYY is the actual UV % intensity reading taken from the sensor probe positioned on the UV vessel. The actual UV % intensity (YYY) is updated continuously.



### Voltage Range

Displays the Factory-set “Low - Hi” Voltage set-points as well as the actual input voltage (YYY/incoming AC voltage). The UV System will not operate properly if operated outside the Voltage set-point range. Damage may incur to ballasts and lamps if the UV System is operated outside of the Voltage set-point range. **DO NOT OPERATE THE UV SYSTEM UNDER “OUT OF RANGE” CONDITIONS.**

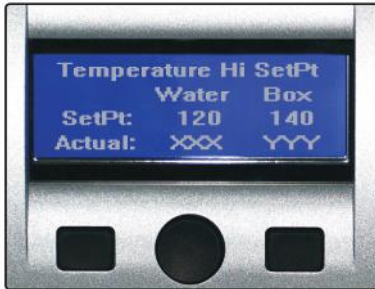

### Temperature Hi

Displays the Factory set UV Vessel “Hi Water Temperature” and “Box (Power Supply Enclosure) “Hi Air Temperature” set-points. Both the “actual” vessel’s water and the enclosure’s air temperature (YYY) are displayed.

## SETUP Menu Text Display

The following options appear on the SETUP Text Display. Four lines of text are viewed on the screen at a given time. Use the “Right” key to advance the arrow (“>”) through the SETUP options. Use the “Enter” key to select the desired SETUP option. Use the “Left” key to return to the MAIN UV System Text Display. Use the “Enter” key to select the desired SETUP option.



### SETUP Options

- 1.) Reset Hour Counter
  - 1A.) Rest Master Counter
  - 1B.) Reset Single Lamp
  - 1C.) Reset All Lamps
- 2.) Scale UV
- 3.) Set UV Low Alarm

The following are brief descriptions of SETUP options. Press the “Left” key to return to the SETUP Menu Text Display for list of options. Once the Text Display returns to the SETUP Menu, press the “Left” key again to return to the MAIN UV System Text Display. If a command is not initiated by using either key within a couple of minutes the system will automatically revert to the MAIN UV System Text Display.

## Initializing Commands/Settings

Use the “Right” key (“>”) to change increment numbers by a factor of one and change NO to YES and YES to NO. The “Big Left” and “Big Right” arrow keys will increment or decrement numbers by a greater amount. Pressing the “Enter” key will accept your adjustments, then return you to the SETUP Menu Text Display.





## SETUP Menu Text Display Options

### RESET Master Counter

Resets the “Master” hour counter. Press the “Right” key to select “Yes”, then press the “Enter” key to complete the command. To exit without making an adjustment select “Left”, this will return you to the SETUP Menu Text Display.



### RESET Single Counter

Resets individual lamp hours. Use the “Right” key to select the desired lamp to reset. Press “Enter” to complete the command. To exit without making an adjustment select “Left”, this will return you to the SETUP Menu Text Display.

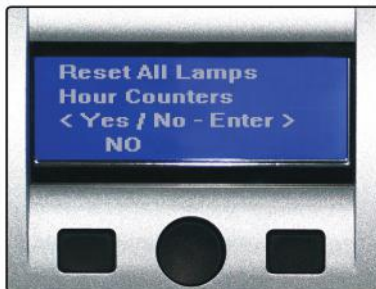

### RESET All Lamp Counters

Resets all lamp hour counters by pressing the “Right” key and selecting YES. Press the “Enter” key to complete the command. To exit without making an adjustment select “Left”, this will return you to the SETUP Menu Text Display.



### SCALE UV% (optional)

Resets the UV Intensity Scale. The actual scale is shown on the screen in the numeric display window. Adjust the UV sensor probe (located on the UV vessel) to the desired distance for a 100% reading. When the distance is set, press the “Enter” key and the UV Intensity reading will be scaled to read 100%. To exit without making an adjustment select “Left”, this will return you to the SETUP Menu Text Display.



### ALARM UV% LOW (optional)

With the UV Intensity (UV 100%) scaling complete, a “Low Alarm” set-point may be set. Use the “Right” key, “Big Left” keys and “Big Right” keys to select desired “Low Alarm” set-point, then press “Enter” to complete the command. To exit without making an adjustment select “Left”, this will return you to the SETUP Menu Text Display.

## ALARM Menu Text Display

The ALARM Menu Text Display uses a “blinking border” to better alert the operator from a distance. The following ALARM Messages appear on the Text Display. Below, a brief description accompanies each ALARM message.

Upon reaching the ALARM Text Display, pressing the “Right” key will advance the operator through additional ALARM screens if more than one ALARM has been activated. Pressing “Enter” will acknowledge the ALARM which will not re-occur after 5 minutes. If no keys are pressed within a couple of minutes the system will automatically return to the MAIN UV System Text Display. All system checks are conducted from the MAIN UV System Text Display and alarms will not re-display until the MAIN UV System Text Display is active.

### ALARM Menu Text Display Messages



#### TEMP Sensor Alarm (optional)

If the water temperature sensor cable is interrupted/disconnected the entire UV system will shutdown and activate an alarm. The PLC Controller must be powered off to reset the system and to restore lamp field operation.



#### VOLTAGE Over Alarm

Identifies that the actual input voltage has exceeded the Factory “High Voltage” Set-Point. DO NOT OPERATE THE UV SYSTEM WHEN THIS ALARM IS ACTIVATED. HIGH VOLTAGE CAN DAMAGE BALLASTS! This alarm turns off the UV lamp(s) and can only be reset by turning the UV System off briefly, then turning it back on.



#### VOLTAGE Under Alarm

Identifies that the actual input voltage has fallen below the Factory “Low Voltage” Set-Point. DO NOT OPERATE THE UV SYSTEM WHEN THIS ALARM IS ACTIVATED. LOW VOLTAGE CAN AFFECT UV OUTPUT! This alarm turns off the UV lamp(s) and can only be reset by turning the UV System off briefly, then turning it back on.



#### ULTRAVIOLET % Under Alarm (optional)

Is activated when UV Intensity has fallen below the operator set “Low” Set-Point. This alarm will re-occur after 5 minutes.

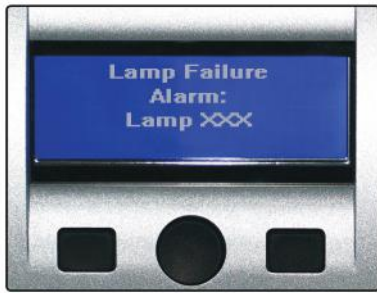

### LAMP Failure Alarm

Identifies that a lamp has failed. The failed lamp number is displayed on the screen. The failed lamp should be replaced within 24 hours or the alarm will reactivate. An investigation should be performed to reveal the cause (water-damage, ballast or lamp) of the failure. After replacing the failed lamp the operator must reset the individual lamp hour counter using "RESET Single Counter" on the SETUP Menu Text Display.

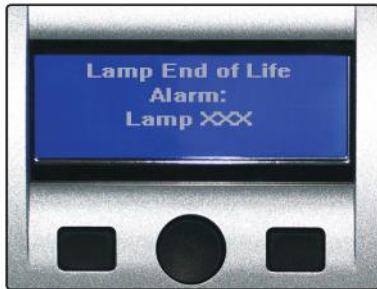

### Lamp End of Life Alarm

Identifies that the lamp(s) have reached their end of useful lamp life cycle (12,000 hours of cumulative operation). Lamps should be replaced at this time as their UV output has degraded below the lamp manufacturer's suggested minimum. After replacing a lamp the operator must reset the individual lamp hour counter using "Reset Single Counter" or if all lamps are changed out, use "Reset All Lamp Counter" with both of these reset options made on the SETUP Menu Text Display.



### Water Temperature OVER Alarm (optional)

Identifies that the water temperature inside the UV vessel has exceeded the Factory High set-point. This alarm, when activated, turns all UV lamps off and can only be reset by turning the UV System off briefly, then turning it back on. This alarm is triggered by over-heating inside the UV vessel that may be a result of an absence of water inside the vessel or identifying a "no-flow" occurrence.



### Enclosure Temperature OVER Alarm

Identifies that the interior of the UV System's Power Enclosure has exceeded the Factory-Set Box/Enclosure Set-point. This alarm, when activated, turns all UV lamps off and can only be reset by turning the UV system off briefly, then turning it back on. This alarm is triggered by the air temperature inside the Power Enclosure exceeding 140° F that may be the result of dirty/clogged air cooling fan filter pads.

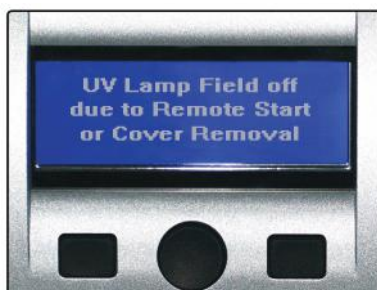

### UV Lamp Field Off Due to Remote Start or Cover Removal Alarm

If the cover switch or remote start option is installed on your system the following message will overlay the main screen whenever the cover is off or the remote start is off. This is to alert the user to the reason the lamps may be off and to remind them to replace the cover when completing maintenance.



## Routine Inspection

The following are required routine maintenance actions:

- A. Daily inspection of the Bioshield® Commercial Vertical UV Sterilizer's Power Supply Enclosure control panel to confirm that the unit is operating satisfactorily (lamp operation).
- B. Daily visual inspection of the UV vessel and piping for leaks.
- C. Monthly inspection for damage/corrosion.
- D. Annual vessel interior inspection/cleaning.
- E. Biannual quartz sleeve inspection/cleaning.
- F. Replace the UV Lamp & Retaining Nut Gasket after 12,000 hours of cumulative operation.
- G. Clean or replace the Cooling Fan Filter Mat monthly, or more frequently in dusty environments.
- H. When the lamps are replaced, calibrate the UV Intensity Sensor.

## UV Lamp Replacement

### Lamp Removal

#### Purpose

To replace expired UV lamp(s)

#### Frequency

A complete set of UV lamps must be replaced after 12,000 hours of cumulative use (manufacturer's suggested useful lamp life rating) or when the UV Intensity is lower than the PLC threshold value.

#### Parts and Equipment Required

- UV Lamp(s)
- Adjustable Wrench
- Wire Cutters
- Clean Cotton or Silicon Gloves
- Personal Safety Equipment



General risk due to pressurized piping and UV vessel!



General risk due to electricity!



DO NOT operate UV Lamp(s) outside of the vessel. UV light may cause severe irritation/damage to eyes and skin.



UV lamp(s) become hot during operation. Handle with care.



UV Lamps are fragile and potentially dangerous if broken. Handle with care.

### Procedure

Read and understand this chapter prior to performing lamp change-out

**Note:** Use clean cotton or silicon gloves when handling the UV lamp(s). Skin oils absorb ultraviolet light and reduce UV intensity. Skin oils may also lead to premature lamp failure.

1. Turn off the Power Supply Enclosure with the External ON/OFF Switch and unplug the UV system from the electrical outlet.

2. With an adjustable wrench loosen (not remove) the Lamp Cable Adapter Nut that will allow the complete Water Tight Connector fitting to be unthreaded from the Quartz Sleeve Retaining Nut without twisting the lamp cable.



3. Unthread the Water Tight Connector Fitting from the Quartz Sleeve Adapter Nut.

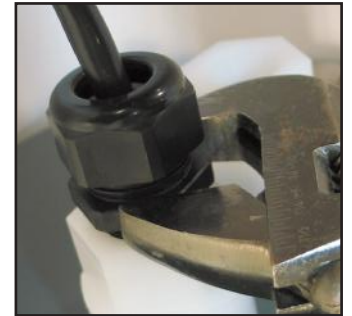

4. Carefully slide the lamp cable's adapter fitting and lamp out of the quartz sleeve (through the Quartz Sleeve Retaining Nut). With part of the UV lamp outside of the vessel, disconnect the lamp cable's 4-Pin Connector from the UV lamp. Use caution connecting/disconnecting UV lamps in vessels mounted vertically. To prevent breakage, be careful not to drop the UV lamps into the quartz sleeve(s). *UV Lamps may be hot, handle with care.*

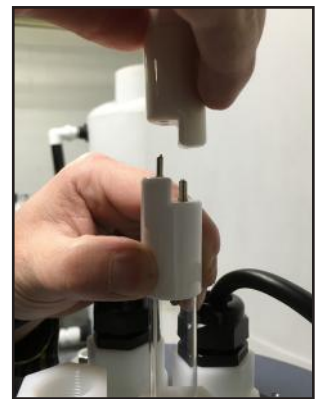

5. With the lamp disconnected from the 4-Pin Connector, carefully slide the lamp out of the quartz sleeve and place in a safe location to avoid breakage.

## UV Lamp Recycling

Disposal of fluorescent bulbs and other mercury-containing bulbs are regulated under the Resource Conservation and Recovery Act, the Universal Waste Rule and Subtitle C of the hazardous waste regulations. Refer to <http://www3.epa.gov/epawaste/hazard/wastetypes/universal/lamps/> to learn more about proper lamp disposal.



## Lamp Installation

See **Pages 11-13** for UV Lamp installation procedure.

## Quartz Sleeve Inspection/Replacement/Cleaning

### Quartz Sleeve Removal

#### Purpose

To inspect or replace broken quartz sleeve(s) in order to maintain required/expected UV intensity.

#### Frequency

Quartz Sleeve(s) should be removed, inspected and cleaned at least once annually (water quality conditions may warrant more frequent inspections/cleaning). Fouled quartz sleeves absorb UV light and therefore may reduce the UV intensity.

## Parts and Equipment Required

- Quartz Sleeve(s)
- Quartz Sleeve Retaining Nut Gasket
- Adjustable Wrench
- Clean Cotton or Silicon Gloves
- Personal Safety Equipment
- White Retaining Nut Tightening Tool (provided with the UV system)



General risk due to pressurized piping and UV vessel!



General risk due to electricity!



Quartz Sleeves are fragile and potentially dangerous if broken. Handle with care.

## Procedure

1. Turn off the Power Supply Enclosure with the External ON/OFF Switch and unplug the UV system from the electrical outlet.
2. Drain the vessel completely.
3. Remove UV lamp(s). See **Page 23** for instructions.

4. Using the white retaining nut tightening tool included with the UV system, unthread the Quartz Sleeve Retaining Nut from the male-threaded Quartz Sleeve Module located on the QSM Faceplate. Once the Quartz Sleeve Retaining Nut is unthreaded the open-end of the quartz sleeve will be exposed.



5. Wearing clean cotton or silicon gloves gently slide the quartz sleeve from the UV vessel. DO NOT use pliers or any tools that may break the quartz sleeve.



6. Remove the Quartz Sleeve Gasket and continue removing the quartz sleeves until all are removed from the vessel. Place quartz sleeves on a safe, level surface to avoid breakage.



7. Inspect all quartz sleeves for cracks, chips and scaling. If required, clean the quartz sleeve(s). See **Page 26** Quartz Sleeve Cleaning. Replace damaged (cracked, chipped) quartz sleeves.

## Quartz Sleeve Cleaning

### Purpose

To manually check and clean quartz sleeve(s).

### Frequency

When required, at least once annually.

### Parts and Equipment Required

- Cleaning Solution of Muriatic Acid and Water (1:4 ratio)
- Acid-Proof Bucket
- Clean Cloth
- Acid-Proof Drop Cloth
- Acid-Resistant Gloves
- MSDS Sheet
- Personal Protective Equipment



General risk due to pressurized piping and UV vessel!



General risk due to caustic cleaning agent!



Quartz Sleeves are fragile and potentially dangerous if broken. Handle with care.

### First Aid Measures:



In case of skin exposure to cleaning agent remove by washing with soap and water immediately.

In case of eye exposure to cleaning agent wash eyes for several minutes with water and contact a physician immediately.

In case of ingestion of cleaning agent contact physician immediately.

### Procedure

1. See **Page 24** for quartz sleeve removal instructions.
2. Inspect quartz sleeve and clean as needed with a soft, clean cloth and mild dish detergent.
3. For calcium deposits use muriatic acid to dissolve/clean deposits. See next page for procedure.
4. Rinse quartz sleeve thoroughly with clean freshwater.
5. See **Page 6** for quartz sleeve installation instructions.

## Quartz Sleeve Installation

See **Page 6** for quartz sleeve installation procedure.

## UV Vessel Cleaning

### Purpose

Over a period of time, dissolved matter can build up on the surface of the quartz sleeves and the interior of the vessel affecting the efficiency of the UV disinfection process. Due to fouling, the available intensity will decrease continuously until the quartz sleeves are cleaned.

**Note:** The use of the optional wiping system merely helps to decrease the frequency of the manual cleaning cycle.

Please be aware that such a decrease also may be caused by aging of the UV lamps or changes in the water quality (UV transmission). Repeat of visual inspections of the UV Sensor or of some example quartz sleeves will help to determine the necessary cleaning intervals needed. The removal of this build-up (calcium, etc.) can be carried out with a cleaning pump. Pentair recommends the use of muriatic acid to chemically clean the quartz sleeves. Materials within the vessel chamber are highly resistant against this acid.

### Frequency

When necessary.

## Parts and Equipment Required

- Cleaning Solution of Muriatic Acid and Freshwater (1:4 ratio)
- Acid-Resistant Transfer Pump
- Acid-Resistant Hose (used to transfer the cleaner from the container to the UV vessel)
- Fittings to connect to vessel
- Acid-Resistant Bucket
- Clean Cloth
- Acid-Resistant Drop Cloth
- Acid-Resistant Gloves
- MSDS Sheet
- Personal Safety Equipment



General risk due to pressurized piping and UV vessel.



General risk due to caustic cleaning agent.



Quartz Sleeves and UV lamps are fragile and potentially dangerous if broken. Handle with care.

### First Aid Measures:

In case of skin exposure to cleaning agent remove by washing with soap and water immediately.



In case of eye exposure to cleaning agent wash eyes for several minutes with water and contact a physician immediately.

In case of ingestion of cleaning agent contact physician immediately.

## Procedure

1. With the quartz sleeves still installed in the UV vessel, turn off the Power Supply Enclosure with the External ON/OFF Switch and unplug the UV system from the electrical outlet.
2. Isolate the UV vessel from the water flow using the required isolation valves and drain the vessel completely.
3. Clear the work area and layout protective drop cloths under the UV vessel.
4. Set up the acid transfer pump and attach the acid input hose to the vessel's water drain valve.
5. Attach an acid return/overflow hose to the UV vessel's upper auxiliary service port and route it back to the acid-resistant bucket. This will be used as the Acid Overflow Recovery Bucket.
6. Using the acid-resistant bucket as an acid supply container, create a chemical solution of one part muriatic acid to four parts water (1:4 acid-to-water ratio).
 

**IMPORTANT: When creating the chemical solution, always introduce the acid to the water and introduce the acid as close to the waterline as possible. This helps prevent acid-to-skin contact resulting from unnecessary splashing.**
7. With all of the hoses attached to the UV vessel and the acid transfer pump attached to the acid supply container, pump acid into the UV vessel until full.
8. Once the UV vessel has been filled with acid, allow the acid to remain in the vessel for 30 minutes.
9. Disconnect the acid transfer pump's vessel feed hose from the transfer pump and use this hose to drain the acid from the UV vessel through the vessel's drain valve and into an acid-resistant bucket.
10. After all of the acid has been drained from the UV vessel and the cleaning procedure completed, rinse the vessel chamber thoroughly to avoid process water from coming in contact with the cleaning agent. The rinse water may be taken from a water tap with the help of a hose and filled and drained through the unit's drain valve port.
11. Neutralize old cleaning agent with bases, e.g. sodium hydroxide solution, sodium carbonate solution in compliance with all relevant rules for accident prevention and local regulations.

## UV Vessel Disassembly

### Purpose

To disassemble the vessel for internal inspection.

### Frequency

UV vessel disassembly is only required if a problem has taken place, such as, quartz sleeve breakage. It is recommended that the QSM (Quartz Sleeve Module) Faceplate only be removed if necessary.

### Parts and Equipment Required

- Adjustable and Torque Wrenches
- Socket Wrenches
- Clean Cotton or Silicon Gloves
- Flashlight
- Personal Safety Equipment



General risk due to pressurized piping and UV vessel!



Quartz Sleeves and UV lamps are fragile and potentially dangerous if broken. Handle with care.

### Procedure

**Important: DO NOT** Attempt to remove the QSM Faceplate with the quartz sleeves assembled. ALL lamps and quartz sleeves MUST be removed before disassembling the QSM Faceplate from the UV vessel.

1. Turn off the Power Supply Enclosure with the External ON/OFF Switch and unplug the UV system from the electrical outlet.
2. Redirect water flow from the vessel using isolation valves and drain the vessel completely.
3. Remove UV lamp(s). See **Page 23** for removal instructions.
4. Remove quartz sleeve(s). See **Page 24** removal instructions.

5. With the vessel completely drained and the UV lamps and quartz sleeves removed, loosen the QSM Faceplate bolts in a diametric sequence. Continue until all hardware is removed.



6. With fastening hardware removed, pull the QSM Faceplate from the UV vessel.
7. Clean out the inside of the UV vessel using a mild dish detergent and rinse thoroughly with clean freshwater.
8. Thoroughly clean the mating surfaces of both the QSM Faceplate and the UV Vessel.

**Important:** Use a new QSM Faceplate Rubber Gasket when re-assembling the faceplate to the vessel.

For replacement parts please refer to Replacement Parts list on page 32 of this manual.

9. Fit the QSM Faceplate Rubber Gasket onto the alignment posts.



**Important:** To properly align the QSM Faceplate, set the #1 lamp position (as stamped on the faceplate, next to the quartz sleeve module) to the 3 O' Clock position when looking at the QSM Faceplate.



10. With the QSM Faceplate loosely aligned, push the QSM Faceplate, with the rubber gasket, in place onto the vessel. Next, loosely install (finger tight) the supplied stainless steel hardware (bolts/washers/nuts).



11. With the hardware loosely installed (finger tight) fine tune the alignment of the #1 lamp position to the 3 O' Clock position. To verify proper alignment install the #1 quartz sleeve as outlined on **Page 6**. The sleeve should go into its respective port on the quartz sleeve coupler on the opposite end of the unit without difficulty. If when installing the sleeve you find it difficult to get the sleeve to engage in its respective port on the quartz sleeve coupler this is an indication that the #1 lamp position is not aligned properly in the 3 O' Clock position. If this is the case, rotate the QSM Faceplate either clockwise or counterclockwise until the sleeve freely engages its respective port on the quartz sleeve coupler.

12. Once the #1 lamp position is confirmed to be properly aligned, establish uniform pressure over the QSM Faceplate by tightening the bolts in 5 ft. • lb. increments in a diametrically opposed (180°) sequence until the recommended torque is obtained. See recommendations below.

Flange Bolt Torque Recommendations:

0.5" to 1.5" Flange = 12 ft. • lbs.

6.0" to 8.0" Flange = 40 ft. • lbs.

2.0" to 4.0" Flange = 25 ft. • lbs.

10" Flange = 64 ft. • lbs.

5.0" Flange = 30 ft. • lbs.

12" Flange = 95 ft. • lbs.





## Cooling Fan Filter Mat Replacement/Cleaning

### Cooling Fan Filter Removal

**Purpose**

The Cooling Fan is equipped with a Filter Mat used to trap airborne particles and dust. This Filter Mat must be routinely inspected and if required, cleaned. A clogged Filter Mat reduces air circulation in and out of the enclosure, potentially allowing electrical hardware to over-heat. If damaged, worn-out or uncleanable replace the Filter Mat.

**Frequency**

Minimum every six months, but more routine inspections may be required due to increased airborne dirt/dust.

**Parts and Equipment Required**

- Slotted Screwdriver

**Procedure**

1. Remove Cooling Fan cover to access Filter Mat.
2. Remove Cooling Fan Filter Mat

### Cooling Fan Filter Cleaning

**Purpose**

To increase air circulation in and out of the enclosure. If damaged, worn-out or uncleanable replace the Filter Mat. A dirty Filter Mat may cause electronic ballast failure.

**Frequency**

A minimum of every six months, but more routine inspections may be required due to increased airborne dirt/dust.

**Parts and Equipment Required**

- Compressed Air
- Dish Detergent

**Procedure**

Read and understand this chapter prior to cleaning Cooling Fan Filter Mat.

1. Remove dust from mat by blowing it out with compressed air or washing it out with soap and water.
2. Dry mat, or use new replacement filter mat.

### Cooling Fan Filter Installation

**Purpose**

To install cleaned or new Cooling Fan Filter Mat.

**Frequency**

A minimum of every six months, but more routine inspections may be required due to increased airborne dirt/dust.

**Parts and Equipment Required**

- Slotted Screwdriver

**Procedure**

Read and understand this chapter prior to cleaning Cooling Fan Filter Mat.

1. Place Cooling Fan Filter Mat into fan.
2. Replace fan cover.



## REPLACEMENT PARTS

Pentair offers several different variants of the Bioshield® Commercial Vertical UV Sterilizer. These variants include several different vessel dimensions, port styles/sizes and controller/monitor options to best fit your individual needs. When contacting us for replacement parts for your UV system, we suggest that you have the UV system's serial number readily available. The serial number can be found on both the Power Supply Enclosure and UV vessel labels.

Identifying the serial number allows us to process your request/order quickly and accurately.

### Quartz Sleeve & UV Lamp Matrix

Bioshield models are available with different size ports and use varying lengths of quartz sleeves. Below we match your unit with the correct quartz sleeve and UV lamp.

Bioshield P/N	Vessel Diameter	Port Size	Quartz Sleeve Length	Quartz Sleeve Part number	UV Lamp Watts	UV Lamp Amalgam Part Number
522904, 522905	6"	2"	46.5"	FL-QZ177-PL	130	FL-3213-PL
522918, 522919	6"	3"	46.5"	FL-QZ177-PL	130	FL-3213-PL
522907, 522908	8"	3"	50.875"	FL-QZ180-PL	130	FL-3213-PL
522920, 522921, 522922	8"	4"	50.875"	FL-QZ180-PL	130	FL-3213-PL
522935	8"	6"	50.875"	FL-QZ180-PL	130	FL-3213-PL
522910	10"	4"	50.875"	FL-QZ180-PL	130	FL-3213-PL
522923, 522924	10"	6"	50.875"	FL-QZ180-PL	130	FL-3213-PL
522912, 522913	12"	6"	55"	FL-QZ187-PL	130	FL-3213-PL

**Illustrated Parts View**

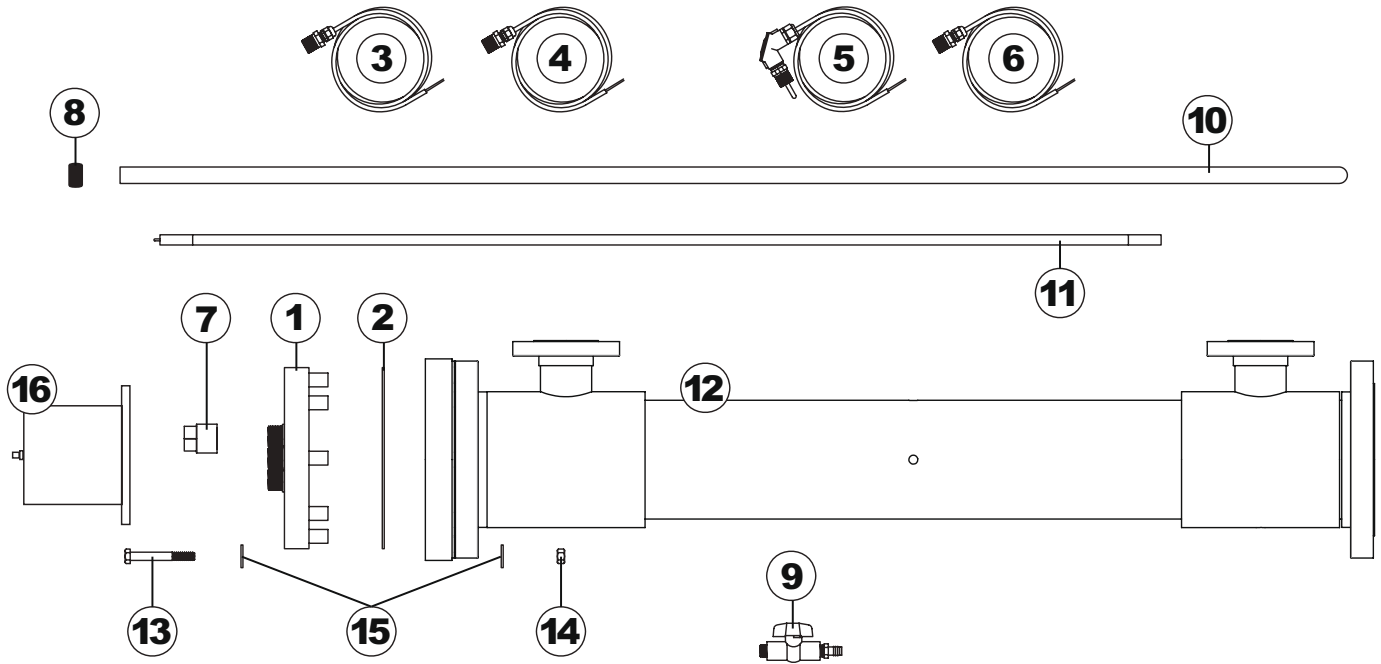

**Replacement Parts List**

1. Quartz Sleeve Module Faceplate.....	Call Pentair w/ Serial Number
2. QSM Faceplate Rubber Gasket.....	Call Pentair w/ Serial Number
3. UV Sensor.....	20210-UVS-PL
4. Optional UV Sensor Extension Cable.....	20214-EXTCABLE-PL
5. Temperature Sensor.....	20217-PL
6. Optional Temperature Sensor Extension Cable.....	20217-EXTCABLE-PL
7. Quartz Sleeve Retainer Nut.....	CL-QSR-28-PL
8. Quartz Sleeve Gasket.....	22004-PL
9. Drain Valve Assembly.....	CLP-DVA-1/2-PL
10. Quartz Sleeve.....	(See page 31)
11. UV Lamp.....	(See page 31)
12. UV Vessel.....	Call Pentair w/ Serial Number
13. Bolt.....	Call Pentair w/ Serial Number
14. Nut.....	Call Pentair w/ Serial Number
15. Washer.....	Call Pentair w/ Serial Number
16. Lamp Field Safety Cover.....	Call Pentair w/ Serial Number

## TROUBLESHOOTING

---

**SITUATION**
**INSPECT FOR:**

UV system will not function with the External ON/OFF Switch in the "On" position

1. No Input Voltage Available
2. Temperature Sensor Cable Plug is Interrupted/Defective
3. Input Voltage is lower than the Factory Set Threshold

UV Lamp does not light

1. Faulty Contact (four-pin connector/lamp pins)
2. Defective Electronic Ballast
3. Defective UV Lamp
4. Water Damage due to Quartz Sleeve Seal Failure

UV Intensity Low

1. Decreased UV Transmissibility
2. UV Lamp reached "End of Life"
3. Quartz Sleeve Fouled
4. Faulty UV Sensor

Enclosure Over-Heating

1. Ambient Temperature above 145° F
2. Defective Thermal Switch
3. Cooling Fan Filter Mat needs to be cleaned
4. Defective Cooling Fan

Quartz Sleeve Seal Failure

1. Cracked/Broken Quartz Sleeve
  2. Failed Quartz Sleeve Retaining Nut O-Ring Seal
-

# SYSTEM SPECIFICATIONS

## Dimensional Drawings

(see next page for dimensional data)

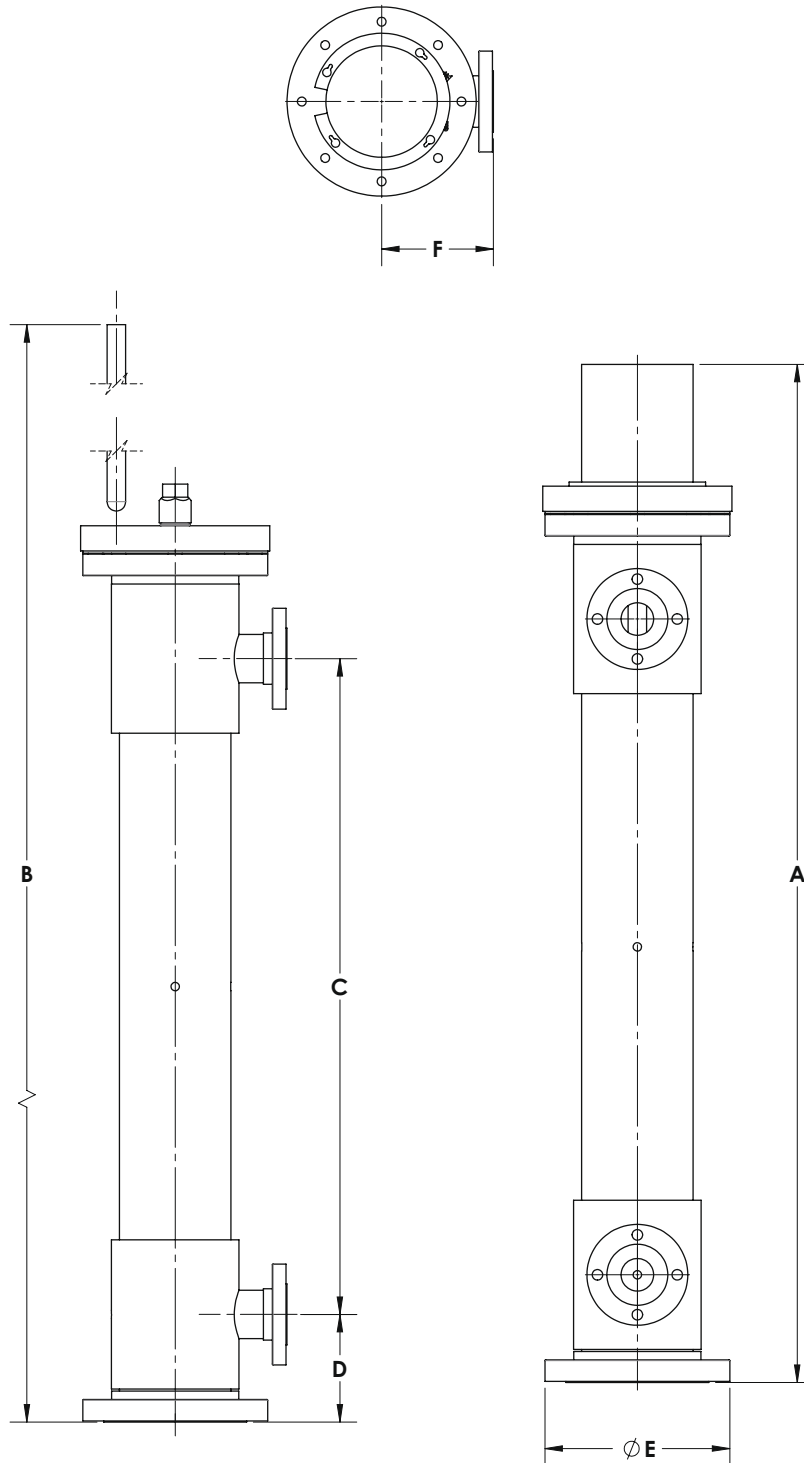

## Dimensional Data

MODEL	BODY SIZE	I/O PORT FLANGE SIZE	VESSEL DIMENSIONS (in Inches)					
			A	B	C	D	E	F
			VESSEL HEIGHT w/ SAFETY COVER	HEIGHT w/ MAINTENANCE CLEARANCE	PORT TO PORT	FLOOR TO INLET	MOUNTING FLANGE OD	CENTERLINE TO PORT FLANGE
522904	6	2	60 1/2	100 5/8	39	6 1/4	11	6 5/8
522905	6	2	60 1/2	100 5/8	39	6 1/4	11	6 5/8
522918	6	3	61 3/4	101 7/8	39	6 7/8	11	7 1/8
522919	6	3	61 3/4	101 7/8	39	6 7/8	11	7 1/8
522907	8	3	67 1/2	106 5/8	37 3/4	9 7/8	13 1/2	10 1/2
522920	8	4	67 1/2	106 5/8	37 3/4	9 7/8	13 1/2	10 7/8
522908	8	3	67 1/2	106 5/8	37 3/4	9 7/8	13 1/2	10 1/2
522921	8	4	67 1/2	106 5/8	37 3/4	9 7/8	13 1/2	10 7/8
522922	8	4	67 1/2	106 5/8	37 3/4	9 7/8	13 1/2	10 7/8
522935	8	6	67 1/2	106 5/8	37 3/4	9 7/8	13 1/2	9 5/8
522910	10	4	73 5/8	117	41 7/8	11 5/8	16	11 7/8
522923	10	6	73 5/8	117	41 7/8	11 5/8	16	10 5/8
522924	10	6	73 5/8	117	41 7/8	11 5/8	16	10 5/8
522912	12	6	76 1/2	120	41 7/8	13 5/8	19	15
522913	12	6	76 1/2	120	41 7/8	13 5/8	19	15

## Electrical Data and Flow Rates

MODEL	FLANGE SIZE	LAMPS/WATTS	INPUT WATTS	UV-C OUTPUT WATTS	UV VESSEL DIMENSIONS (H X D)	POWER ENCLOSURE DIMENSIONS (H X W X D)	AMPS MAX LOAD @ 120/230 VAC	MAX PSI/BAR	40 MJ/CM <sup>2</sup> GPM/LPM	60MJ/CM <sup>2</sup> GPM/LPM	MAX HEAD LOSS PSI
522904	2"	1/130	130	40	57" X 6"	16" X 14" X 8.4"	2.1/1.0	50/3.4	49/190	33/128	1 - PSI
522905, 522918	2", 3"	2/130	260	80	57" x 6"	16" x 14" x 8.4"	3.9/2.0	50/3.4	90/349	60/233	1 - PSI
522919	3"	3/130	390	120	57" x 6"	16" x 14" x 8.4"	5.8/2.9	50/3.4	125/484	83/322	1 - PSI
522907, 522920	3", 4"	3/130	390	120	63" x 8"	16" x 14" x 8.4"	5.8/2.9	50/3.4	167/647	111/430	1 - PSI
522908, 522921	3", 4"	4/130	520	160	63" x 8"	20.2" x 16.3" x 8.4"	7.5/3.7	50/3.4	227/880	151/585	1 - PSI
522922, 522935	4", 6"	5/130	650	200	63" x 8"	24.6" x 20.2" x 10.6"	9.4/4.7	50/3.4	272/1054	181/701	1 - PSI
522910, 522923	4", 6"	6/130	780	240	68" x 10"	24.6" x 20.2" x 10.6"	11.2/5.6	50/3.4	365/1414	244/946	1 - PSI
522924	4", 6"	7/130	910	280	68" x 10"	24.6" x 20.2" x 10.6"	13.3/6.5	50/3.4	430/1666	287/1112	1 - PSI
522912	6"	7/130	910	280	75" x 12"	24.6" x 20.2" x 10.6"	13.3/6.5	50/3.4	492/1907	328/1271	1 - PSI
522913	6"	8/130	1040	320	75" x 12"	30.5" x 24.1" x 12.6"	15.0/7.5	50/3.4	555/2151	369/1430	1 - PSI

## Sizing Chart

Model No.	Max Flow Rate @ 40 mJ/cm <sup>2</sup>	Max Flow Rate @ 60 mJ/cm <sup>2</sup>	Turnover Rate in GPM			
			6 Hours @ 40 mJ/cm <sup>2</sup>	6 Hours @ 60 mJ/cm <sup>2</sup>	8 Hours @ 40 mJ/cm <sup>2</sup>	8 Hours @ 60 mJ/cm <sup>2</sup>
522904-AQ	49 GPM	33 GPM	17,640	11,880	23,520	15,840
522905-AQ	90 GPM	60 GPM	32,400	21,600	43,200	28,800
522906-AQ	125 GPM	83 GPM	45,000	29,880	60,000	39,840
522907-AQ	167 GPM	111 GPM	60,120	39,960	80,160	53,280
522908-AQ	227 GPM	151 GPM	81,720	54,360	108,960	72,480
522909-AQ	272 GPM	181 GPM	97,920	65,160	130,560	86,880
522910-AQ	365 GPM	244 GPM	131,400	87,840	175,200	117,120
522911-AQ	430 GPM	287 GPM	154,800	103,320	206,400	137,760
522912-AQ	492 GPM	328 GPM	177,120	118,080	236,160	157,440
522913-AQ	555 GPM	369 GPM	199,800	132,840	266,400	177,120
<b>Lamp Life</b>			1.37	1.37	1.37	1.37

## PRODUCT WARRANTY

---

Pentair Water Pool and Spa, Inc. (Pentair) warrants the Bioshield® Commercial Vertical UV Sterilizer to be free from defects in material and/or workmanship for a period of one (1) year from the original date of purchase.

The UV Sterilizer must be registered at [www.pentairpool.com/support/product-registration.html](http://www.pentairpool.com/support/product-registration.html) and a copy of the sales receipt and an installer's invoice must be provided to Pentair within sixty (60) days of purchase in order to receive the full one (1) year extended warranty.

If product is not registered within sixty (60) days of purchase the UV sterilizer will be ineligible for the extended warranty and will only receive a sixty (60) day limited warranty.

### **Pentair Warranty Obligations**

Should a defect in workmanship and/or material in any part covered by this warranty become evident during the term of the warranty, then upon the customer following the procedures set forth below, Pentair will, at its sole option, repair or replace such part, in lieu of repair.

Pentair is not, however, responsible under this warranty for any cost of shipping or transportation of the product or parts thereof to or from the Technical Service Department. Also, Pentair is not liable for any loss of time, inconvenience, incidental expenses such as telephone calls, labor or material charges incurred in connection with the removal or replacement of the Rebel cleaner, or any other incidental or consequential damages.

The above mentioned warranty is void if the product is repaired or altered in any way by any persons, agents or representatives other than those authorized by Pentair. Reasonable vehicle trip and evaluation charges may be assessed by a Pentair service representative.

*PLEASE NOTE:* Some states do not allow the exclusion or limitation of incidental or consequential damages, so the above limitation or exclusion may not apply to you.

### **No Other Warranties**

To the maximum extent permitted by applicable law, Pentair disclaims all other warranties, either expressed or implied, including, but not limited to, implied warranties of merchantability and fitness for a particular purpose, with regard to the product, part(s) and/or any accompanying written materials.

### **Procedure for Obtaining Performance**

In order to obtain the benefits of this warranty, the consumer who made the original retail purchase must contact the Pentair Technical Service Department as soon as possible after discovery of the product related issue, but in no event later than the expiration date of the respective warranty periods provided herein. Upon receipt of this communication, Pentair will promptly notify the customer of the address to which the product may be shipped. The customer shall then ship the product, freight prepaid, to the address indicated, together with a "RETURN GOODS AUTHORIZATION" form obtained from Technical Service and a brief description of the problems encountered. Unauthorized returns will not be accepted. Freight must be prepaid by customer.

### **Warranties or Representations by Others**

No third party has any authority to make any warranties or representation concerning Pentair or its products. Accordingly, Pentair is not responsible for any such warranties or representations.

### **Other Rights**

This warranty gives you specific legal rights and you may also have other rights, which vary from state to state.

### **Sole Warranty**

Supersedes all previous publications.



1620 HAWKINS AVE., SANFORD, NC 27330 • (919) 566-8000  
10951 WEST LOS ANGELES AVE., MOORPARK, CA 93021 • (805) 553-5000

[WWW.PENTAIRCOMMERCIAL.COM](http://WWW.PENTAIRCOMMERCIAL.COM)

All Pentair trademarks and logos are owned by Pentair or one of its global affiliates. Pentair Commercial Aquatics™ and Bioshield® are trademarks and/or registered trademarks of Pentair Water Pool and Spa, Inc. and/or its affiliated companies in the United States and/or other countries. Unless expressly noted, names and brands of third parties that may be used in this document are not used to indicate an affiliation or endorsement between the owners of these names and brands and Pentair Water Pool and Spa, Inc. Those names and brands may be the trademarks or registered trademarks of those third parties. Because we are continuously improving our products and services, Pentair reserves the right to change specifications without prior notice. Pentair is an equal opportunity employer.

© 2017 Pentair Water Pool and Spa, Inc. All rights reserved. This document is subject to change without notice.



P/N 960064 REV. B 1/4/17