

**NOTE:**

*To secure, use waterproof non-toxic wood glue to hold the boxes & frames together. You may also pre drill holes and use screws to hold boxes & frames together.*

**WHAT COMES WITH THE KIT**

**A** (1) - Inner Cover

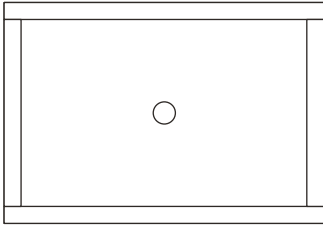

**D** (2) - Brood Side

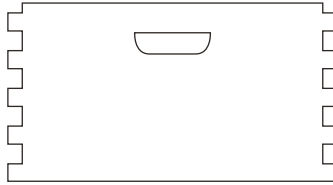

**H** (2) - Brood Front

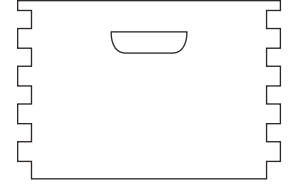

**B** (1) - Bottom Board

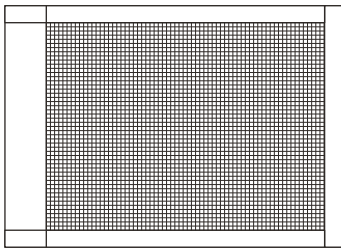

**E** (2) - Super Side

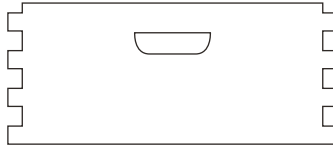

**J** (2) - Super Front

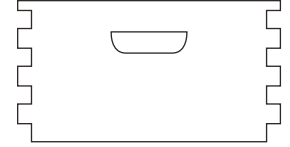

**C** (1) - Telescoping Outer Cover

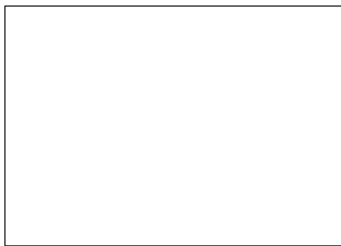

**F** (10) - Brood Foundation

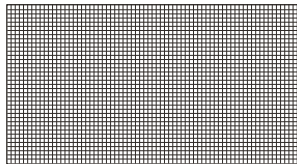

**K** (20) - Super Frame Side



**L** (20) - Brood Frame Side



**G** (10) - Super Foundation

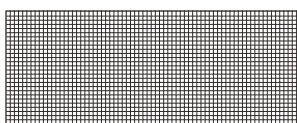

**M** (20) - Frame Top

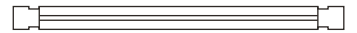

**N** (20) - Frame Bottom



**STEP 1 - BOX ASSEMBLY**

**NOTE:**

- Repeat instructions for the Super boxes as well. Replacing part E for D and J for H.
- When aligning the Fronts (H&J) make sure the top lip is facing in toward the inside of the box.

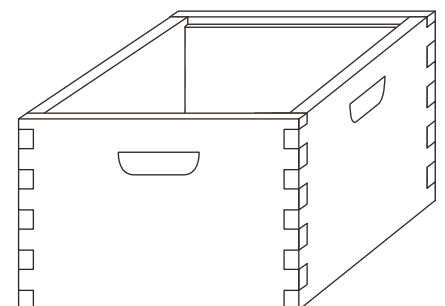
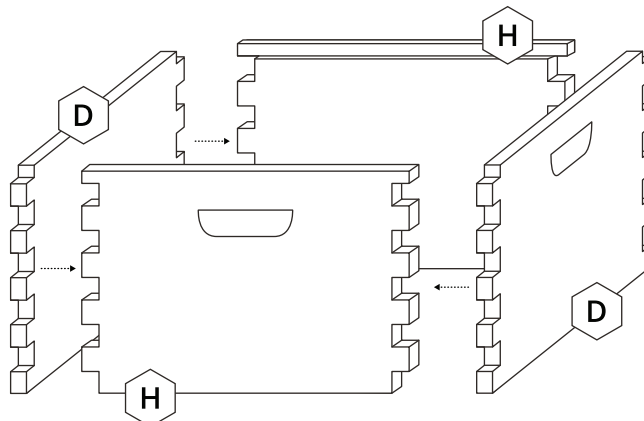

## STEP 2 - FRAME ASSEMBLY

**NOTE:**

You will repeat instructions for the Super Frames and Foundations as well. Replacing part L for K and F for G.

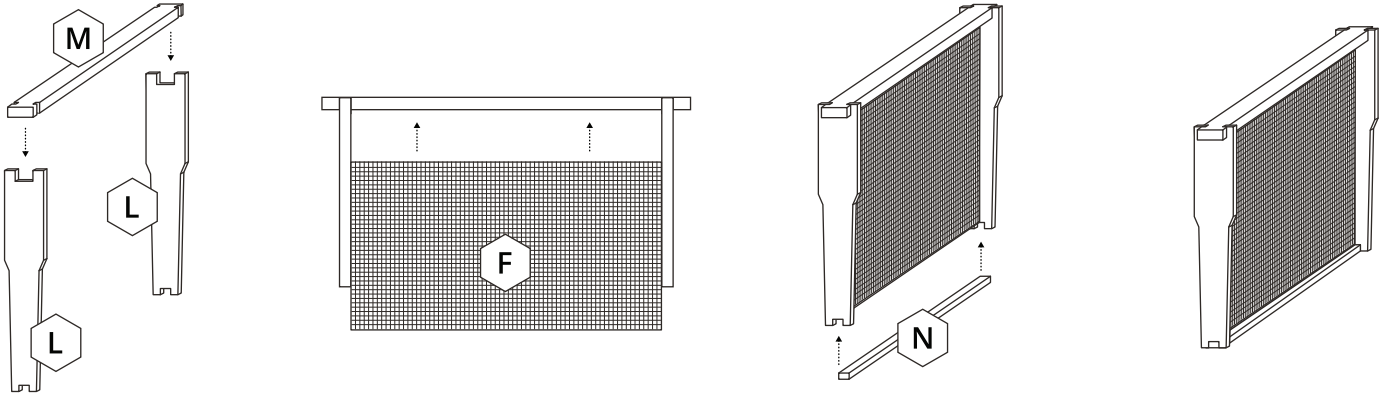

## STEP 3 - FINAL ASSEMBLY

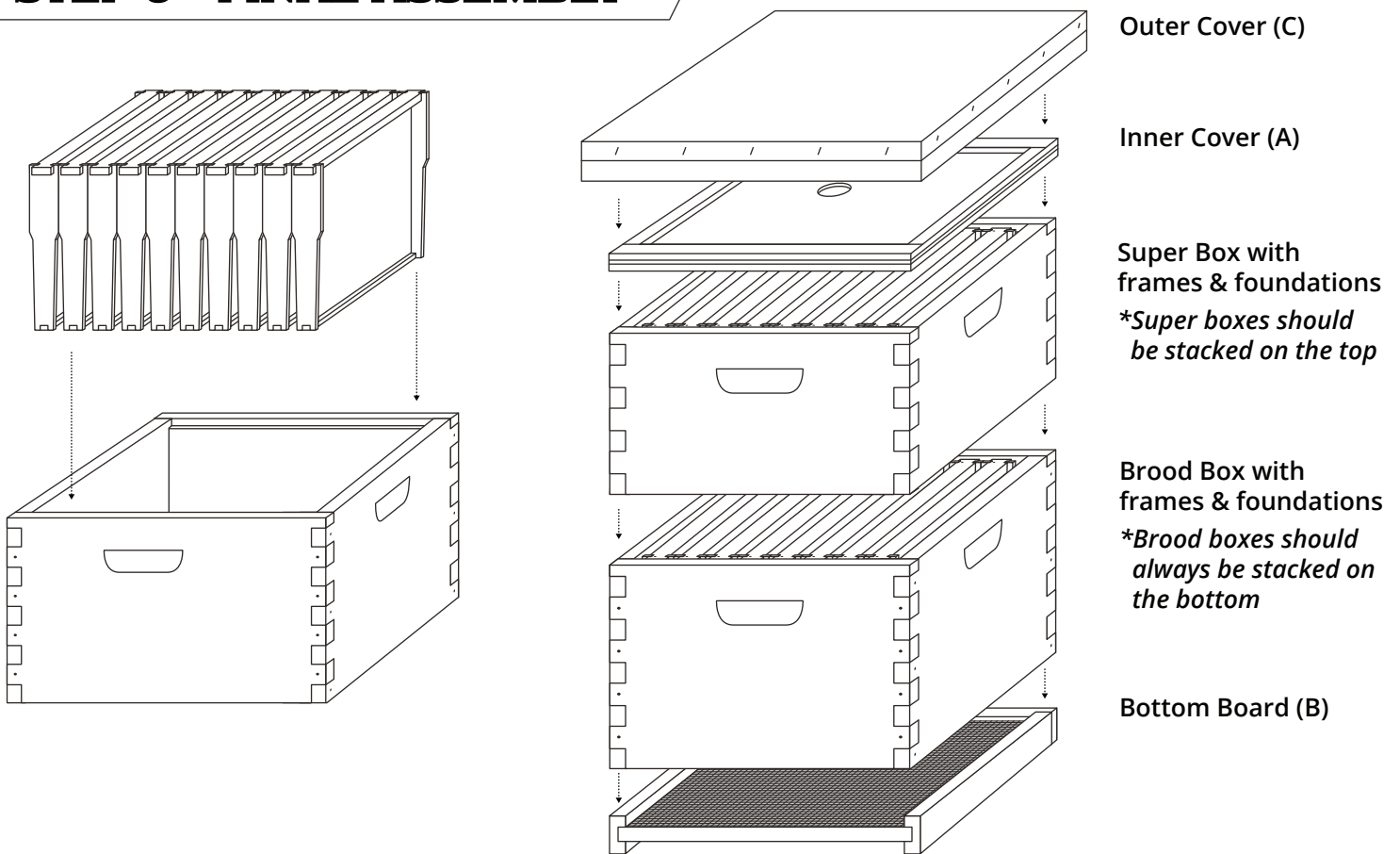

## PACKING CHECKLIST

- |   |   |  |
|---|---|--|
| <input type="checkbox"/> (1) - Inner Cover  | <input type="checkbox"/> (2) - Brood Front        | <input type="checkbox"/> (20) - Brood Frame Side |
| <input type="checkbox"/> (1) - Bottom Board | <input type="checkbox"/> (2) - Super Front        | <input type="checkbox"/> (20) - Super Frame Side |
| <input type="checkbox"/> (1) - Outer Cover  | <input type="checkbox"/> (10) - Brood Foundations | <input type="checkbox"/> (20) - Top Frame        |
| <input type="checkbox"/> (2) - Brood Side   | <input type="checkbox"/> (10) - Super Foundations | <input type="checkbox"/> (20) - Bottom Frame     |
| <input type="checkbox"/> (2) - Super Side   |   |  |