

**Sales Code:** NBV280

**Description:** Rectangular Basin 465 X 235 X 120

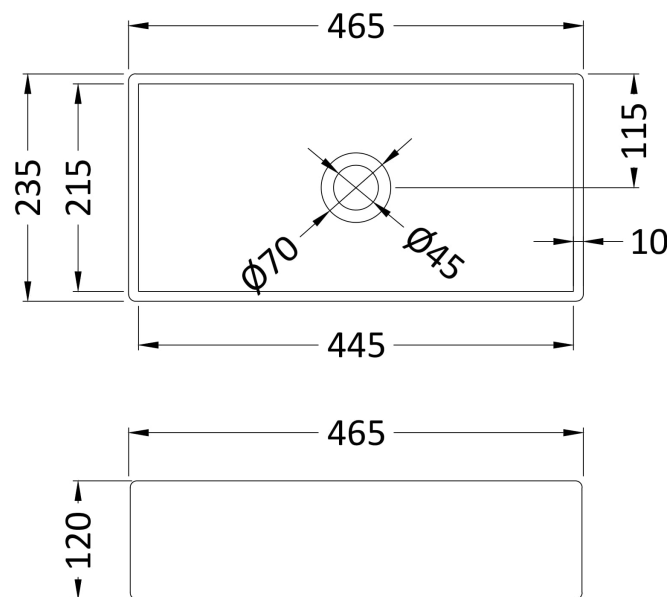

**Product Dimensions**

Height (mm):	120
Width (mm):	465
Depth (mm):	235
Nett Weight (kg):	7.5

**Packaging Dimensions**

Height (mm):	135
Width (mm):	475
Depth (mm):	245
Gross Weight (kg):	8

**Packaging Data**

Box Colour:	Brown Cardboard Box
Box Qty:	1
Label Size:	100 x 50
Label Colour:	White Label
Label Qty:	2

**Outer Box Dimensions (If Applicable)**

Height (mm):	
Width (mm):	
Depth (mm):	
Gross Weight (kg):	
Barcode:	5056462625263

**Product Details**

Country of Origin:	China
Fitting Instruction:	No
Certification: CE & UKCA:	WRAS: WRAS No:
Product Material:	Vitreous China
Fixing Supplied:	No

**Pans/Bidets:** Trap Style: N/A Includes Seat: Not Applicable

**Seats:** Seat Type: N/A Material: Not Applicable  
Function: Not Applicable Hinge Type: Not Applicable  
Hinge Material: Not Applicable

**Cisterns:** Operating Type: Not Applicable Fittings: Not Applicable  
Lever Type: N/A

**Basins:** Tap Hole: No Tapholes Chain Stay Hole: No  
Template: Not Required Waste Type Req: Unslotted  
Overflow Inc: No Overflow Cover: No  
Inner Bowl Depth (mm): 110mm