

hiboy

# S2/S2 Pro

Electric Scooter



USER MANUAL

The manufacturer reserves the right to make changes to the product and update this manual at any time.

# Contents

1	Package Contents	01
2	Product Overview	02
3	Assembly and Set up	03
4	Charging	04
5	Riding Basics	04
6	Safety Instructions	06
7	Dangerous Actions (No Attempting!)	08
8	Safety Reminder	10
9	Folding and Carrying	11
10	Daily Care and Maintenance	14
11	Specifications	18
12	Instructions of Seat Assembly(Optional)	20
13	Limited Warranty Statement	21
14	Hiboy App	23
15	Q&A and Trouble shooting	24
16	Contact Us	27

## 1. Package Contents

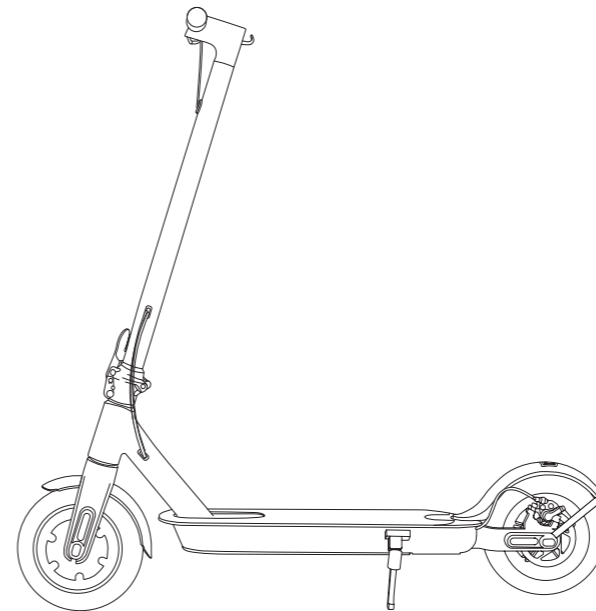

Carefully check package contents, if anything is missing or damaged, please contact Hiboy customer service for support: [support@hiboy.com](mailto:support@hiboy.com).



Allen Wrench



4 x Screws

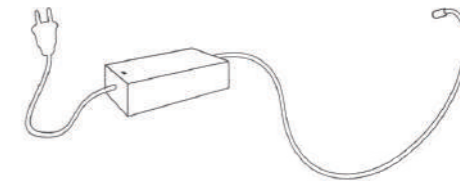





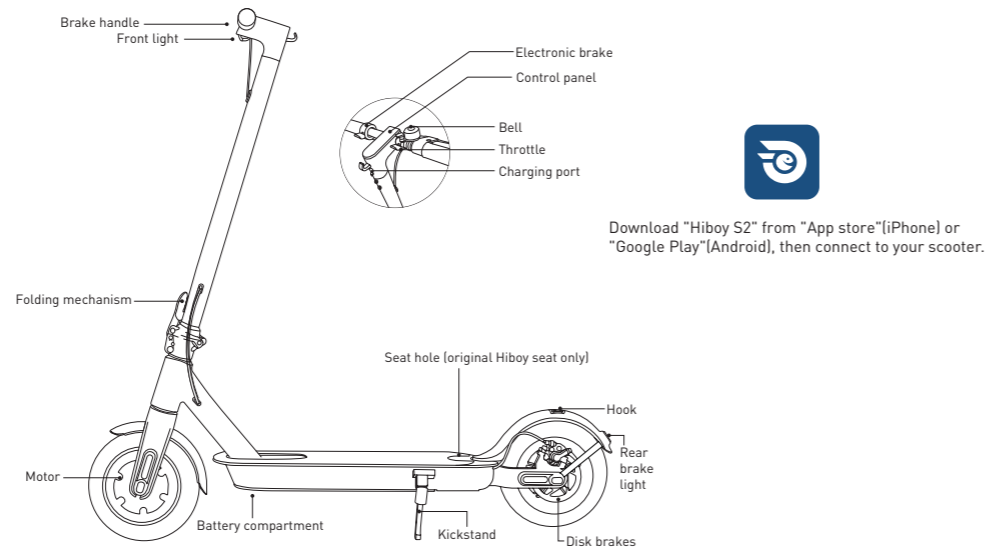

Charger

## 2. Product Overview



### Control Panel

	<b>Power Button</b>	When the scooter is off, press the button to turn on the scooter; When the scooter is on, press and hold for 3 seconds to turn off the scooter.
	<b>Light</b>	After the scooter is turning on, press the button to turn on or off all the lights (the front light, side LED lights and rear light).
	<b>Mode</b>	Press twice to switch the speed mode, Red S indicates Sport mode (max speed 19 mph), and Green S indicates Drive mode (max speed 13 mph)
	<b>Temperature</b>	When the icon lights up, please pull over to the side of the road to cool down the scooter.
	<b>Cruise Control</b>	Quick press the power button 3 times to turn on (you will hear "Bi Bi") or turn off (you will hear "Bi") the cruise control function.
	<b>Battery Indicator</b>	The power level is indicated by five power lights on the control panel. As power is consumed, the lights will change from solid to flashing, and finally turn off. When all 5 power lights are on, the battery level is between 80%-100%; When 4 lights are solid, the battery level is between 60%-80%, and so on. When the last power light flashes, it indicates low power. Please recharge soon for further use.

## 3. Assembly and Set up

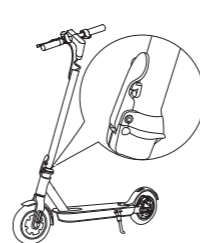

1. Unfold the stem and push the folding lever until you hear a click. Then unfold the kickstand to support the scooter.

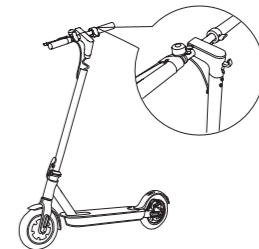

2. Attach the handlebar to the stem. Make sure it's right way round.

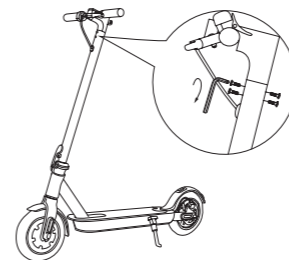

3. Use the Allen wrench to fix 4 screws, make sure it's tightened.

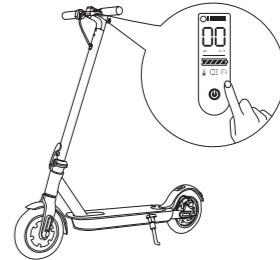

4. Ensure your scooter powers on and off.

## 4. Charging

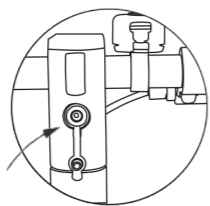

Open the rubber cover

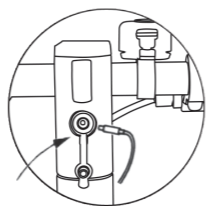

Insert the charger plug in

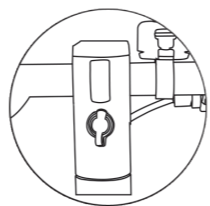

Fill and fix the rubber plug after the charging

Your scooter will be fully charged when the LED light on the charger changes from red (charging) to green (fully charged). After a period of full charge, it will automatically cut off the charging. Even so, we still don't recommend to charge your scooter for a long time. Do not connect the charger if the charging port is wet. Cover the charging port when not use.

## 5. Riding Basics

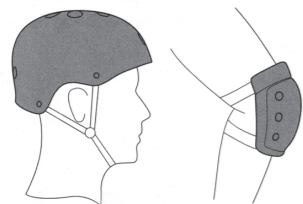

Always wear a helmet and safety gear so to avoid falling and injury during the driving learning, as shown in the figure.

4

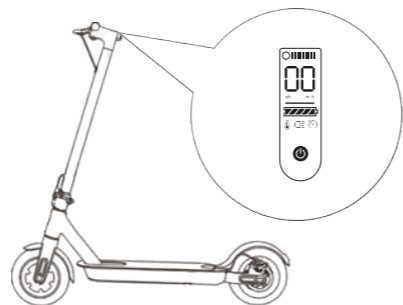

1. Turn the power on, and check the power indicator.  
Note: The scooter can not be turned on during charging

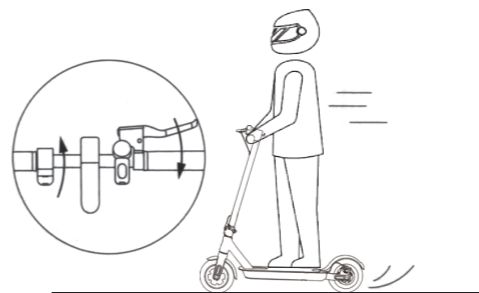

4. Release the throttle to reduce the speed slowly. Squeeze the brake lever for a sudden brake.

5



2. Step on the deck with one foot, and slowly kicks off the other on the ground.

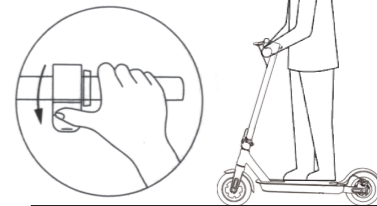

3. When the scooter starts to coast, put both feet on the deck and press the throttle (the throttle initiates once the coasting speed exceeds 3.1 mph).

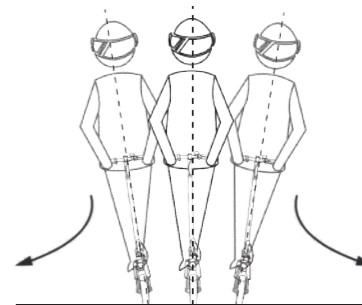

5. Tilt your body to the steering direction as you turn, and turn the handlebar slowly.

## 6. Safety Instructions



 Do not ride in the rain.



 Keep your speed between 3.1-6.2 mph when you ride through speed bumps, elevator door sills, bumpy roads or other uneven surfaces. Slightly bend your knee to better adjust mentioned surfaces

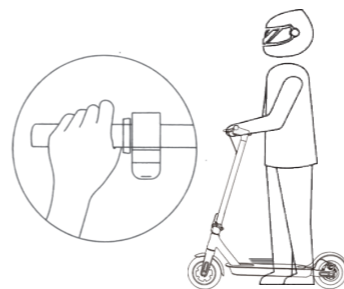

 Do not press the throttle when you're walking alongside the scooter.



 Always steer clear of obstacles.

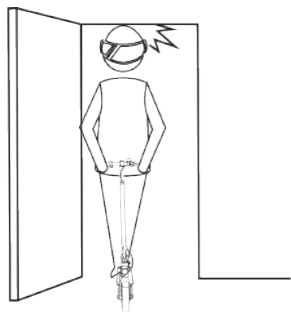

 Look out for doors, elevators and other overhead obstacles.



 Do not accelerate when you go downhill.



 Do not hang bags or other heavy stuff on the handlebar.



 Keep both feet on the deck all time.

## 7. Dangerous Actions (No Attempting!)

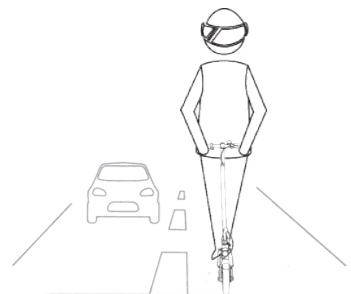

⊘ Do not ride in traffic lanes or residential areas where vehicles and pedestrians are both allowed.



⊘ Do not ride in a ponding that is higher than 0.78 inches.

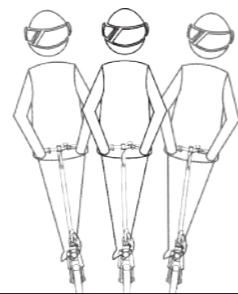

⊘ Do not turn the handlebar violently during high-speed riding

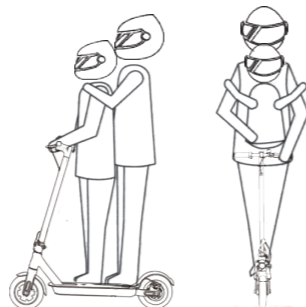

⊘ Do not ride with anyone else, including children.



⊘ Do not keep your feet on the rear mudguard.



⊘ Do not keep your hands away from handlebar.

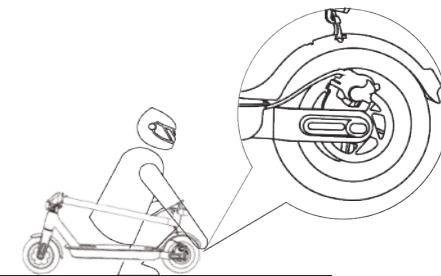

⊘ Do not touch the disc brake.

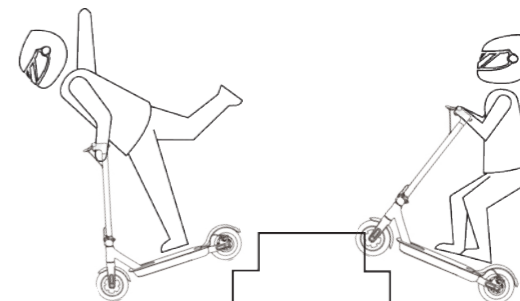

⊘ Do not try riding up or down stairs, and jumping over obstacles

## 8. Safety Reminder

● This electric scooter is a leisure device. But once they're in a public area, they'll be seen as vehicles, subjecting to any risks faced by vehicles. For your safety, please follow instructions in the manual and traffic laws and regulations set forth by government and regulatory agencies. (Pour votre sécurité, veuillez suivre les instructions contenues dans le manuel et les lois sur la circulation et les règlements énoncés par les organismes gouvernementaux et réglementaires).

● At the same time, you should understand that risks cannot be entirely avoided as others may violate traffic regulations and drive incautiously, and you're exposed to road accidents just as when you're walking or biking. The faster the scooter is, the longer it takes to stop. On a smooth surface, the scooter may slip, lose balance, and even result in a fall. Thus it is crucial that you use caution, keep proper speed and distance, especially so when you're unfamiliar with the place.

● Respect pedestrians' Right of Way. Try not to startle them while driving, especially children. When you ride from behind pedestrians, ring your bell to give them a heads-up and slow your scooter to pass from their left (applicable to countries where vehicles drive on the right). When you ride across pedestrians, keep to the right at a low speed. When you drive across pedestrians, keep the lowest speed or getting off the vehicle

● Closely follow the safety instructions in the manual especially in the countries that lack relevant laws and regulations regarding electric scooters. Hiboy shall not be liable for any financial losses, physical injuries, accidents, legal disputes and other interest conflicts resulted from actions that violate user instructions.

● Do not lend your scooter to whoever doesn't know the operations. And when you do lend it to your friends, please take the responsibility to ensure he/she knows the operation and wears the safety gear.

● Check the scooter before every use. When you note loosen parts, low battery alerts, excessive wear, strange sounds, malfunctions and other abnormal conditions, stop riding immediately and call for professional support.

● Devices are not intended for use at elevations greater than 2000 m above sea level Prolonged Exposure to UV Rays, Rain and the Elements May Damage the Enclosure Materials, Store Indoors When Not in Use

- **WARNING – Risk of Fire – No User Serviceable Parts.**
- **AVERTISSEMENT - Risque d'incendie - Aucune des pièces ne peut être réparée par l'utilisateur**

## 9. Folding and Carrying

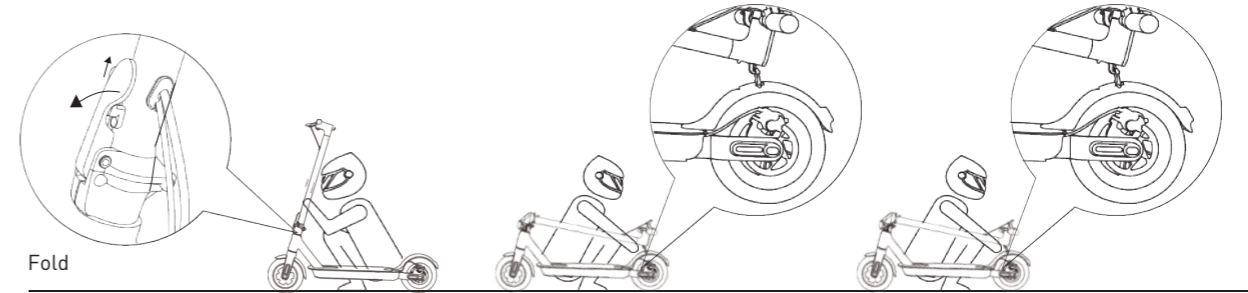

Fold

Make sure that the scooter's turned off. To fold, unlock the folding mechanism, and bend the handlebar stem to hook the clamp on the rear fender. To open, unhook from the clamp, erect the handlebar and lock the folding structure.



Carry

Hold the handlebar stem with either one hand or both hands to carry.

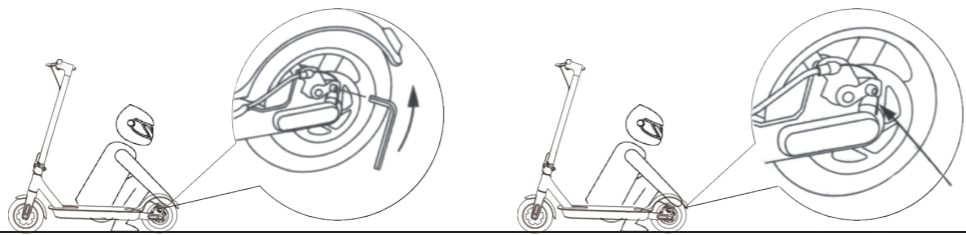

If the brake is too tight, use the allen wrench to loosen the screws on the caliper, and slightly send back the brake cable to shorten the exposed length, then tighten the screws. If the brake is too loose, loosen the screws, and slightly pull out the brake cable to lengthen the exposed length, then tighten the screws.

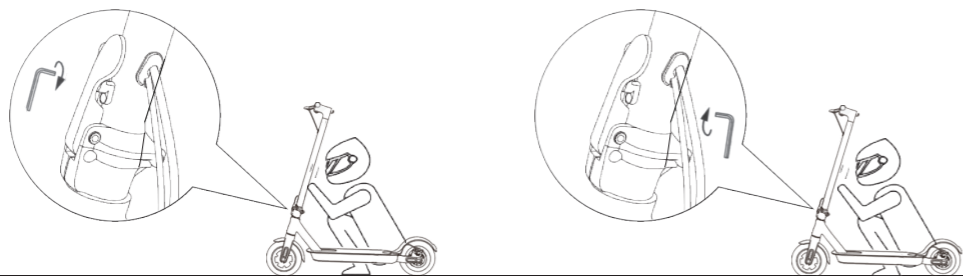

If the handlebar and its stem sway during riding, please tighten the screws on the folding mechanism.

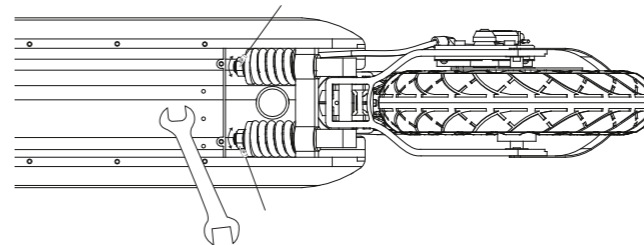

We have pre-adjusted the rear suspension to make it be workable for 165 lbs+ users, if you feel the suspension is too loosen or tight, then please use No. 14 wrench to adjust the two nuts on the suspension and make it more tight or loosen until you feel the suspension is working well for your weight.



## 10. Daily Care and Maintenance

### Cleaning and storage

If you see stains on the scooter's body, wipe them off with a damp cloth. If the stains won't scrub off, put on some toothpaste, and brush them with a toothbrush, then wipe them off with a damp cloth. If you see scratches on plastic parts, use sandpaper or other abrasive materials to polish them.

Notes: do not clean the scooter with alcohol, gasoline, kerosene or other corrosive and volatile chemical solvents to prevent dire damage. Do not wash the scooter with a high-pressure water spray. During cleaning, make sure that the scooter's turned off, the charging cable is unplugged, and the rubber flap is closed as water leakage may result in electric shock or other major problems.

When the scooter's not in use, keep it indoors where it is dry and cool. Do not put it outdoors for long time. Excessive sunlight, overheating and overcooling accelerate tire aging and compromise the scooter and the battery pack's lifespan.

(Lorsque le scooter n'est pas utilisé, gardez-le à l'intérieur dans un endroit sec et frais. Ne le mettez pas en plein air pendant longtemps. La lumière du soleil excessive, la surchauffe et le sur-refroidissement accélèrent le vieillissement des pneus et compromettent le scooter et la durée de vie de la batterie.)



### WARNING!

#### Battery maintenance

1. Use original battery packs, use of other models or brands may bring about safety issues;
2. Do not touch the contacts. Do not dismantle or puncture the casing. Keep the contacts away from metal objects to prevent short circuit which may result in battery damage or even injuries and deaths;
- 3. Use original power adapter to avoid potential damage or fire;**
4. Mishandling of used batteries may do tremendous harm to the environment. To protect natural environment, please follow local regulations to properly dispose used batteries;
- 5. After every use, fully charge the battery to prolong its lifespan.**

Do not place the battery in an environment where the ambient temperature is higher than 104°F or lower than 14°F (e.g., do not leave the scooter or the battery pack in a car under direct sunlight for an extended time). Do not throw the battery pack into fire as it may lead to battery failure, battery overheating, and even another fire. **If the scooter is expected to be left idle for more than 30 days, please fully charge the battery and place it in a dry and cool place. Keep in mind to recharge it every 60 days to protect the battery from potential damage which is beyond limited warranty.**

Always charge before exhausting the battery to prolong the battery's lifespan. The battery pack performs better at normal temperature, and poor when it is below 32°F. For instance, when it is below -4°F, the riding range is only half or less at normal state. When the temperature rises, the riding range restores.

The damage caused by prolonged no charge is irreversible and is beyond limited warranty. Once the damage is done, the battery can not be recharged.

**ISED Canada Statement:**

This device contains licence-exempt transmitter(s)/receiver(s) that comply with Innovation, Science and Economic Development Canada 's licence exempt RSS(s). Operation is subject to the following two conditions:

(1) this device may not cause interference and

(2) this device must accept any interference, including interference that may cause undesired operation of the device.

Radiation Exposure: This equipment complies with Canada radiation exposure limits set forth for an uncontrolled environment

To maintain compliance with IC's RF Exposure guidelines, this equipment should be installed and operated with minimum distance of 5mm the radiator your body. This device and its antenna(s) must not be co-located or operation in conjunction with any other antenna or transmitter

Déclaration de l'ISED Canada:

Cet appareil contient des émetteurs / récepteurs exempts de licence qui sont conformes aux RSS exemptes de licence d'Innovation, Sciences et Développement économique Canada. L'opération est sous réserve des deux conditions suivantes :

(1) cet appareil ne peut pas causer d'interférences et

(2) ce dispositif doit accepter toute interférence, y compris peut provoquer le fonctionnement indésirable de l'appareil.

Exposition aux rayonnements: Cet équipement est conforme aux radiations du Canada limites d'exposition pour un environnement incontrôlé Pour maintenir le respect des guides d'exposition RF d'IC, cquipment doit être installé et actionné avec une distance minimale de 5mm le radiateur de votre corps. Cet appareil et ses antennes ne doivent pas être co-localisé ou en opération en conjonction avec toute autre antenne ou émetteur

**FCC Warning Statement**

Changes or modifications not expressly approved by the party responsible for compliance could void the user' s authority to operate the equipment. This equipment has been tested and found to comply with the limits for a Class B digital device, pursuant to Part 15 of the FCC Rules. These limits are designed to provide reasonable protection against harmful interference in a residential installation. This equipment generates uses and can radiate radio frequency energy and, if not installed and used in accordance with the instrucons, may cause harmful interference to radio communications. However, there is no guarantee that interference will not occur in a particular installation. If this equipment does cause harmful interference to radio or television reception, which can be determined by turning the equipment off and on, the user is encouraged to try to correct the interference by one or more of the following measures:

-- Reorient or relocate the receiving antenna.

-- Increase the separation between the equipment and receiver.

-- Connect the equipment to an outlet on a circuit different from that to which the receiver is connected.

-- Consult the dealer or an experienced radio/TV technician for help.

This device complies with part 15 of the FCC Rules. Operation is subject to the following two conditions:

(1) This device may not cause harmful interference, and

(2) This device must accept any interference received, including interference that may cause undesired operation.

The device has been evaluated to meet general RF exposure requirement.

## 11. Specifications

S2	Items	Specifications
Dimensions	L × W × H [1]	45.7*16.9*47.2 inch (116*43*120 cm)
	After folding: L × W × H	45.7*16.9*19.3 inch (116*43*49 cm)
Weight	Item weight	31.7 lbs (14.4 kg)
Riding requirements	Max. load[2]	220 lbs (100 kg)
	Age	16-50
Main parameters	Max. speed	19 mph(30 km/h)
	Max. range[3]	17 mile(27 km)
	Max. climbing angle [%]	Approx. 15
	Operating temperature	14-104 (°F)
	Storage temperature	14-104 (°F)
	IP rating	IPX4
Battery pack	Rated voltage	36V DC
	Max. input voltage	42V DC
	Rated capacity	7.5 Ah
	Intelligent battery management system	Unusual temperature/short circuit/under voltage/over current protections...etc
Wheel Motor	Rated power	350W
	Max. power	500W
Charging adapter	Output power	63W
	Input voltage	100-240 V
	Output voltage	42V DC
	Output current	1.5 A
	Charging time	3-5 hours

[1] Item height: from the ground to the top of the scooter;

[2] Max. load: the maximum allowable weight shall be kept within 220 lbs (driver and objects included) in any case. Consider an extra weight of the clothes or other accessories with us during the trip and the gravity generated by speed, the scooter will not support it if this load limit is exceeded.

[3] MAX range: measured when it is no wind and at 77°F, the scooter's fully charged to ride at a even speed of 11.4 mph (18.4 km/h) on a at surface with a load of 165 pounds (75 kg).

The real battery life vary with different factors of the load , humidity , wind speed and operation habits...etc.

S2 Pro	Items	Specifications
Dimensions	L × W × H [1]	45.3*16.5*47.6 inch (115*43*120 cm)
	After folding: L × W × H	45.3*16.5*19.3 inch (115*43*49 cm)
Weight	Item weight	37.4 lbs (17 kg)
Riding requirements	Max. load[2]	220 lbs (100 kg)
	Age	16-50
Main parameters	Max. speed	19 mph(30 km/h)
	Max. range[3]	25 mile(40 km)
	Max. climbing angle [%]	Approx. 15
	Operating temperature	14-104 (°F)
	Storage temperature	14-104 (°F)
	IP rating	IPX4
Battery pack	Rated voltage	36V DC
	Max. input voltage	42V DC
	Rated capacity	11.6 Ah
	Intelligent battery management system	Unusual temperature/short circuit/under voltage/over current protections...etc
Wheel Motor	Rated power	500W
	Max. power	750W
Charging adapter	Output power	84W
	Input voltage	100-240 V
	Output voltage	42V DC
	Output current	2 A
	Charging time	4-6 hours

[1] Item height: from the ground to the top of the scooter;

[2] Max. load: the maximum allowable weight shall be kept within 220 lbs (driver and objects included) in any case. Consider an extra weight of the clothes or other accessories with us during the trip and the gravity generated by speed, the scooter will not support it if this load limit is exceeded.

[3] MAX range: measured when it is no wind and at 77°F, the scooter's fully charged to ride at a even speed of 11.4 mph (18.4 km/h) on a at surface with a load of 165 pounds (75 kg).

The real battery life vary with different factors of the load , humidity , wind speed and operation habits...etc.

## 12. Instructions of Seat Assembly(Optional)



1. Seat components a, b, c



2. Insert b into a



3. Make b perpendicular to a, and tighten it with wrench



4. Insert the seat into c, and tighten the screw rod and press down the seat clamp as shown in the figure.



5. The seat assembly is completed



6. Insert the assembled seat into the hole on the scooter.



7. Open the safety ring.



8. Pull the fixed handle and put the seat down



9. Tighten screw with a hexagonal wrench.



10. Fasten the fixed handle.



11. Lock the safety ring.



12. Seat assembly completed.

\* The seat is not included, please purchase separately from hiboy store\*

## 13. Limited Warranty Statement

### 30 DAY SATISFACTION GUARANTEED RETURN POLICY

If you are unsatisfied with your purchase, Hiboy's return policy allows you to return your undamaged Hiboy product purchased on the Authorization channel within 30 days counting from the date of receipt of shipment, and request a refund from the Authorization channel for any reason. Note: The cost of return shipping will be borne by the customer if the product has no quality issue.

For the return request, Hiboy is not responsible for lost packages due to the carrier, or products received that cannot be verified. Received products that have damage determined to have been caused by the end-user may be subject to denial of the return request.

### TO QUALIFY FOR A REFUND, ALL THE FOLLOWING CONDITIONS MUST BE MET:

1. A Return Merchandise Authorization (RMA) must be requested from Hiboy within 30 days from the date of receipt of shipment. To request an RMA, contact Hiboy Service Team at support@hiboy.com.
2. The cost of return shipping will be borne by the customer.
3. For warranty service, please keep your receipt and/or invoice to validate proof of purchase.
4. Returned product must be in good physical condition (not physically broken or damaged).
5. All accessories originally included with your purchase must be included with your return.
6. If you return a product to Hiboy, (a) without an RMA from Hiboy (b) without all parts included in the original package, Hiboy retains the right to refuse delivery of such return.

### LIMITED PRODUCT WARRANTY

Hiboy product basically will be free from defects in materials and workmanship under normal use for a period aforementioned. Hiboy does not warrant the operation of the product will be uninterrupted or error-free. Hiboy is not responsible for damage arising from failure to follow instructions relating to the product's usage.

## REMEDIES

If a hardware defect is found and a valid claim is received by Hiboy within the Warranty Period, Hiboy will, at its option and to the extent permitted by law, either (1) repair the product at no charge, using new or refurbished replacement parts or, (2) replace the product with a new or refurbished product. In the event of a defect, to the extent permitted by law, these are your sole and exclusive remedies. Shipping and handling charges may apply except where prohibited by applicable law. This Limited Warranty is valid only in the jurisdictions where the products are sold by [www.hiboy.com](http://www.hiboy.com), and is valid to the extent permitted by the applicable laws of such jurisdictions. Any replacement hardware product will be warranted for the remainder of the original warranty period or thirty (30) days, whichever is longer, or for any additional period of time that may be applicable in your jurisdiction.

## HOW TO OBTAIN WARRANTY SERVICE

A Warranty Service Order must be requested from Hiboy within Warranty Period from the date of receipt of shipment. To request a Warranty Service Order, contact Hiboy Service Team [support@hiboy.com](mailto:support@hiboy.com).

To obtain warranty service, you must deliver the product, in either its original packaging or packaging providing an equal degree of protection, to the address specified by Hiboy. In accordance with applicable law, Hiboy may require the customer to furnish proof of purchase details and/or comply with registration requirements before receiving warranty service. period or thirty (30) days, whichever is longer, or for any additional period of time that may be applicable in your jurisdiction.

## LIMITATION OF DAMAGES

Except to the extent prohibited by applicable law, Hiboy shall not be liable for any incidental, indirect, special, or consequential damages, including but not limited to loss of profits, revenue or data, resulting from any breach of express or implied warranty or condition, or under any other legal theory, even when Hiboy has been advised of the possibility of such damages. Some jurisdictions do not allow the exclusion or limitation of special, indirect, incidental or consequential damages, so the above limitation or exclusion may not apply to you.

## 14. Hiboy App

1. Scan the QR code to download Hiboy App.  
The App password is "888888".

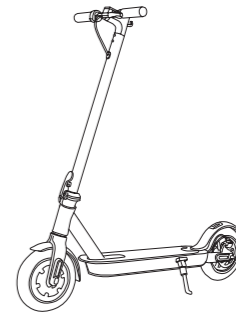
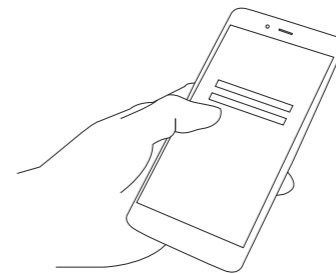

2. Turn on the Scooter.

3. Select the device to connect.

4. After connecting with the scooter, you can use the App to control the scooter, such as change the Speed mode, Speed unit, lock / unlock the scooter, turn on / off the lights...etc.

Have fun with Hiboy electric scooter.

## 15. Question & Answer

1. Is there any necessary information need to be included before contacting with Hiboy Support Team?

A: Yes, if you need any support from Hiboy, please contact us at support@hiboy.com, and please always include your order number, correct model No., descriptions of the problem, pictures, and videos that can show details about the issue in the email, thanks.

2. My scooter can't be turned on, what can I do?

A: First please make sure you are not turning on the scooter during charging, because for safety consideration, we have set the scooter can't be turned on during charging. Second please make sure the scooter has been charged for a while to have enough battery to support it can be turned on, otherwise please contact us at support@hiboy.com for further support.

3. I can't charge my scooter, what's the problem?

A: Please note if the scooter is charging, then the led on the charger will show red color, if the scooter is fully charged, then the led on the charger will show green color. So please help to verify if the charger is defective first: Plug the charger into the socket but not connecting to scooter, if the charger led is NOT on or it is NOT green color, then it means the charger is defective. If the charger is not defective, please contact us at support@hiboy.com for further support.

4. When I tried to log in the App, it shows the user doesn't exist, how can I solve it?

A: Please click on the "register" and use your email to register for the App first, and then your email can be used as an account for the App.

5. Why I can't receive the verification code when registering the App?

A: The code will be sent to your email, please also check the spam box in your email to get the code.

6. I can't register the App successfully, what can I do?

A: Please send the email you used for App registration, your mobile version [iPhone or Android] and the screenshot where you met problem during registration to support@hiboy.com, we will check and help out.

7. I forgot the password for the App, can I reset it?

A: Yes, please click "Forgot password" to reset your password.

8. It shows "The device is activated, please reset the device before proceeding", what I can do?

A: Please note one scooter can only be connected to one App account, this means the scooter is connected by others (maybe your friend), please ask he/she to unbind or delete the device on his/her App account, then you can connect with it.

9. What if the E-Scooter arrived missing accessory or broken part?

A: Please take a photo and send to Hiboy Support Team's email: support@hiboy.com, Hiboy Support Team will reply you soon and send correct accessory or part replacement.

10. How to attach the seat?

A: Please refer to the assembly steps in this manual, and you can also search for "how to assemble Hiboy seat" on Google, and then you can find some Youtube tutorial videos.

11. Is that possible to replace some components for example the rear fender?

A: Yes, please take a photo and send to Hiboy Support Team's email: support@hiboy.com, Hiboy Support Team will reply you soon.

12. My scooter is stolen, can you help me?

A: I'm sorry we can't track on the location or serial number of the scooter, please call the local policeman and ask them for help.

13. I have written several emails to support@hiboy.com, but no responses received, why?

A: Our Hiboy Support Team will reply to you within 1 working day, if you didn't receive any reply from us, please also kindly check your spam box, and add support@hiboy.com on your whitelist to make sure our reply is not blocked. In addition, you can also contact us on the platform where you purchased the scooter for example Amazon chat box, leave message on hiboy.com website, eBay chat box...etc.

14. When I press on the throttle, why the scooter is not moving?

A: Please note our scooter is set with a kick-off start function considering safety factors, which means you need to stand on the scooter, kick it off to reach a certain minimum speed 3.1 mph, then when you press down the throttle, the scooter will accelerate further, you can check about this kick-off start operation description in the user manual, too.

15. What can I do with the App?

A: Via the App you can turn on / off the lights, lock / unlock the scooter, set the max speed, turn on / off cruise control or Zero start (Kick-off start) function, change the speed unit, modify the scooter name, checking the scooter status for example speed, riding distance, battery capacity...etc.

16. Why the speed can't reach 19 mph?

A: Please make sure you have double clicked the power button to set the speed mode to Sport mode, because we have two speed modes, one is green S mode with max speed 13 mph, the other one is red S mode with max speed 19 mph. After setting the speed mode to red S mode and the speed still can't reach 19 mph, then please check if you have modified the max speed on App by accident. In addition, the battery status, rider weight and road situation will also influence the max speed, with enough battery, within 220 lbs weight and ride on flat road can reach 19 mph speed easily.

17. Why the max distance is lower than advertised max distance?

A: Please note the max distance is measured when it is no wind and at 77°F, the scooter's fully charged to ride at a even speed of 11.4 mph (18.4 km/h) on a at surface with a load of 165 pounds (75 kg). The real battery life vary with different factors of the load , humidity , wind speed and operation habits...etc.

18. Can I ride the scooter in the rainy days?

A: Kindly note the scooter waterproof level is IPX4, we don't suggest you to ride it in the rainy days.

19. What's the password for the App?

A: Kindly note the correct App for S2, S2R and S2 Pro is "Hiboy S2", and the password is "888888", and you can long press the electronic brake and power button at the same time for 5 seconds to reset the password to "888888".

20. Is there any caution for storing the scooter if I need to go out for a long time vacation?

A: Please make sure the scooter is stored in a dry & cool place, do not put it outdoors for long time, and if the scooter is expected to be left idle for more than 30 days, please fully charge the battery, keep in mind to recharge it every 60 days to protect the battery from potential damage which is beyond limited warranty.

## Trouble shooting

Error code	Error description	Solution
E1 / F1	Brake error	Need to replace the disc brake lever
E2 / F2	Throttle error	Need to replace the throttle
E3	There is problem for the communication between the top display and controller inside the frame	Need to replace the top display PCB and the display-controller connection cable
E4	Over current protection, when E4 appears, both electronic brake and throttle will stop working	Normally the E4 will disappear automatically after cool down the scooter for a while, if the E4 continues to show up frequently, then need to replace the controller
E5	Low voltage protection, when the battery voltage is lower than 30V, it will show up E5	First charge the scooter and see if E5 disappears, if E5 doesn't disappear after charging, then need to replace the battery
E6	Over voltage protection, when the battery voltage is higher than 46V, it will show up E6	When E6 shows up, please do not brake suddenly or climb / go down slopes, just consume some power of the battery, then it will be back to the normal
E7	Motor hall error	Need to check if the motor hall cables are connecting well first, if any cable is not connecting well, re-connect it and see if the E7 error disappears; After re-connecting the haul cables and E7 still exists, then need to replace the motor.
E8	Motor phase error	Need to replace the motor.
E9	Hardware error	Restart the scooter for several times and see if the E9 disappears, otherwise need to replace the controller

## 16. Contact Us

Contact us if you experience issues relating to riding, maintenance and safety, or errors/faults with your Hiboy S2 / S2 Pro

E-mail Service: [support@hiboy.com](mailto:support@hiboy.com)



@Hiboy\_Official



HiboyUS



@HiboyUS



[www.hiboy.com](http://www.hiboy.com)