

HIBOY

Electric Scooter
Hiboy S2/S2 Pro

HIBOY

The manufacturer reserves the right to make changes to the product, and update this manual at any time.
Visit www.hiboy.com to download the latest user materials.

www.hiboy.com

USER MANUAL

Contents

1	Package Contents	01
2	Product Overview	02
3	Assembly	03
4	Charging	04
5	Riding Basics	04
6	Riding Notice	06
7	Dangerous Actions (No Attempting!)	08
8	Safety Instructions	10
9	Folding and Carrying	11
10	Daily Care and Maintenance	12
11	Specifications	14
12	Instructions of Seat Assembly(Optional)	16
13	Limited Warranty Statement	17

1. Package Contents

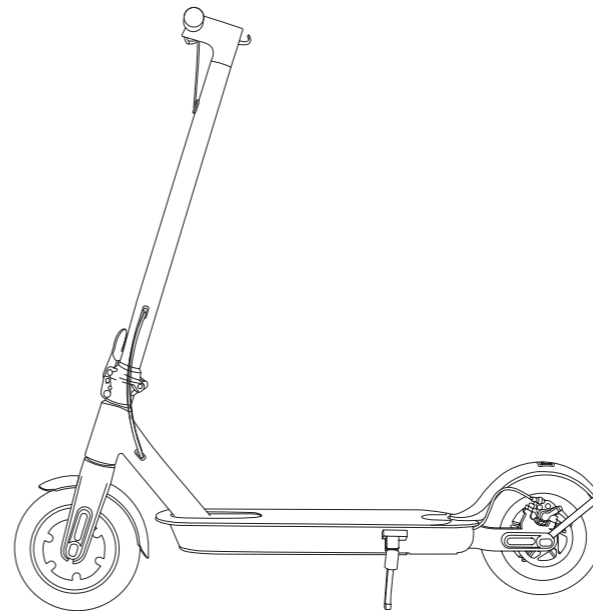

Carefully check package contents, if anything is missing or damaged, please contact Hiboy customer service for support: us.support@hiboy.com



Allen Wrench



4 x Screws

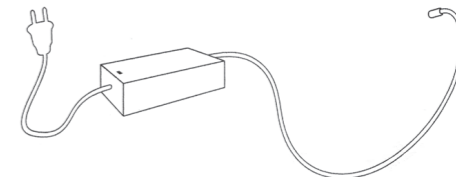





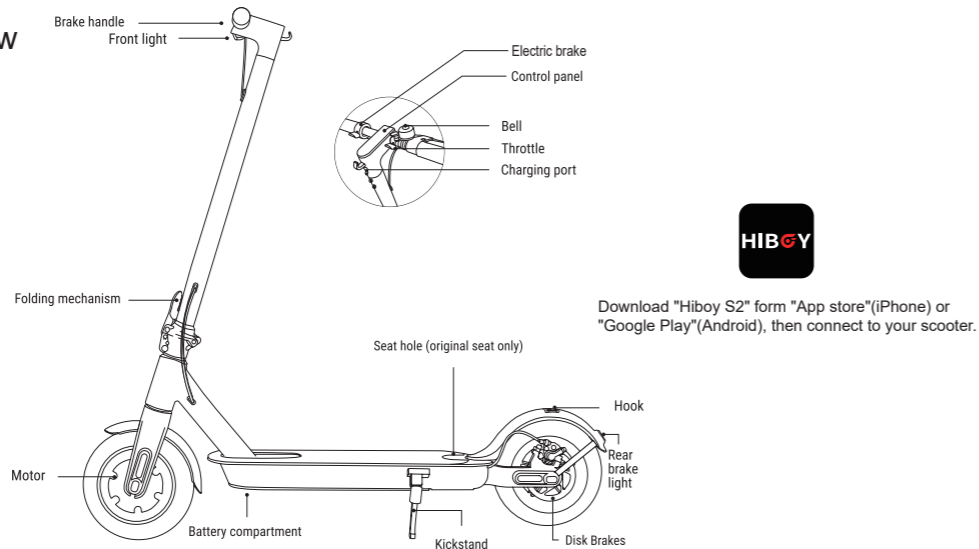

Charger

2. Product Overview



Download "Hiboy S2" form "App store"(iPhone) or "Google Play"(Android), then connect to your scooter.

Control Panel

	Power Button	When the scooter is off, press the button to turn on the scooter; When the scooter is on, press and hold for five seconds to turn off the scooter.
	Battery Indicator	The power level is indicated by five power lights on the control panel.
	Light	When the scooter is on, one-tap will turn on/off the front light and side LED lights.
	Mode	Double-tap to change the riding mode. Red indicates sports mode, and green light indicates comfort mode.
	Temperature	When the icon lights up, please pull over to the side of the road to cool down the scooter.
	Cruise Control	When the icon lights up, you have activated cruise control.

3. Assembly

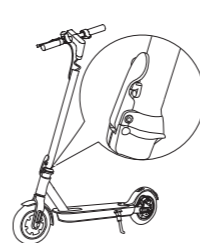

1. Unfold the stem and push it until you hear a click. Then unfold the kickstand to support the scooter.

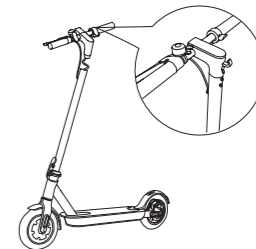

2. Slide the handlebar onto the stem. Make sure it's right way round.

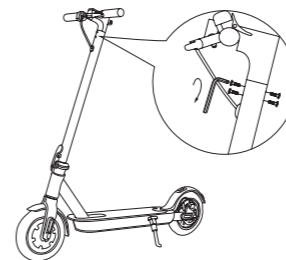

3. Screw four of the screws provided(two on each side) with the provided Allen wrench.

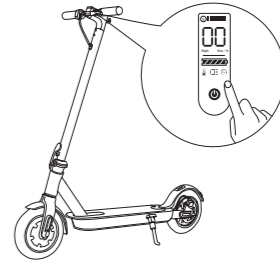

4. Ensure your scooter powers on and off.

4. Charging

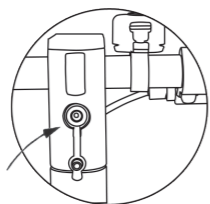
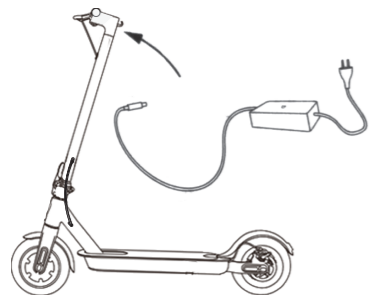

Open the rubber plug

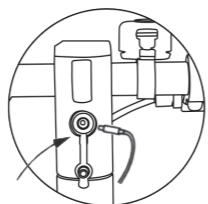

Insert the charging plug in

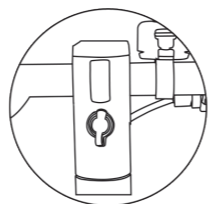

Fill and fix the rubber plug after the charging

Your scooter will be fully charged when the LED light on the charger changes from red (charging) to green. After a period of full charge, the charging will automatically cut off. Even so, we still don't recommend charging your scooter for a long time. Do not connect the charger if the charging port is wet. Cover the charging port when not use.

5. Riding Basics

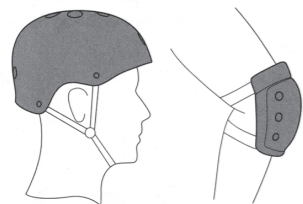

Always wear a helmet and safety gear so to avoid falling and injury during the driving learning, as shown in the figure.

4

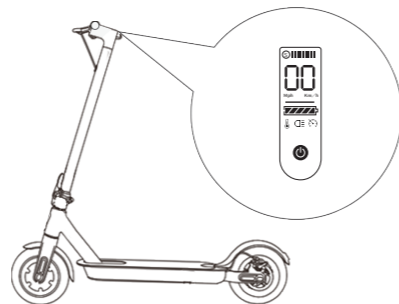

1. Turn the power on, and check the electricity indicator.



2. Stand on the base with one foot and propel yourself with the other foot.

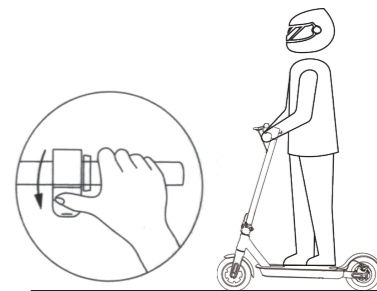

3. When the electric scooter begins to glide, put both feet on the deck and press the accelerator. The speed shall be kept above 3.1mph (5km/h) for starting the throttle.

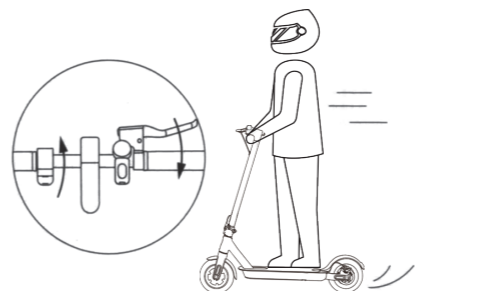

4. Release the throttle and to reduce the speed slowly. Squeeze the brake lever for a sudden brake.

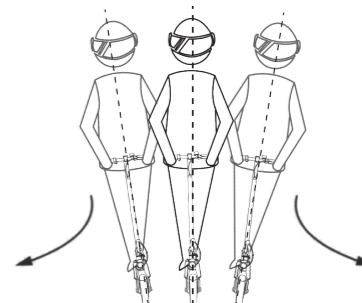

5. Tilt your body to the steering direction as you turn, and turn the handlebar slowly.

5

6. Riding Notice



 Do not ride in the rain.



 Please keep a medium or low speed (5mph) when you ride through speed bumps, elevator door sills, bumpy roads or other uneven surfaces. Slightly bend your knee to better adjust mentioned surfaces.

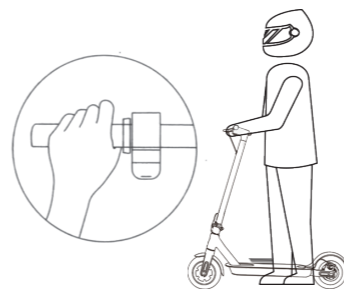

 Do not press the throttle when walking with the scooter.



 Always steer clear of obstacles.

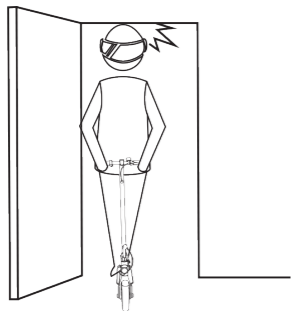

 Look out for doors, elevators and other overhead obstacles.



 Do not accelerate when you go downhill.



 Do not hang bags or other heavy stuff on the handlebar.

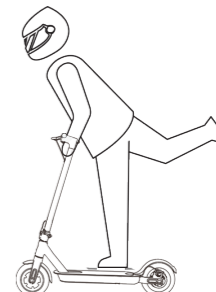

 Keep both feet on the deck all time.

7. Dangerous Actions (No Attempting!)

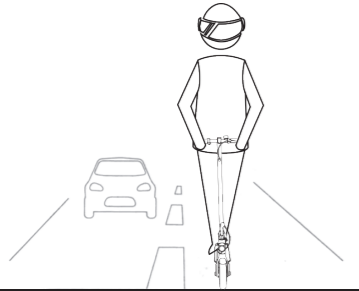

⊘ Do not ride in traffic lanes or residential areas where vehicles and pedestrians are both allowed.



⊘ Do not ride in a ponding that is higher than 0.79 inches.

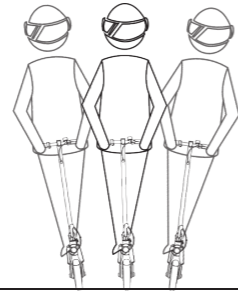

⊘ Do not turn the handlebar violently during high-speed riding



⊘ Do not ride with anyone else, including children.

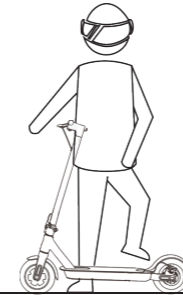

⊘ Do not keep your feet on the rear mudguard.



⊘ Do not keep your hands away from handlebar.

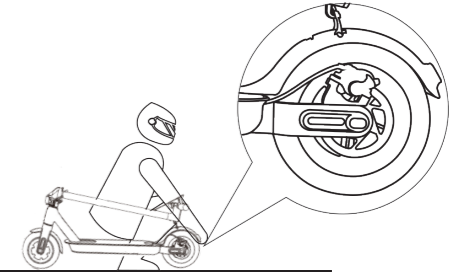

⊘ Do not touch the disc brake.

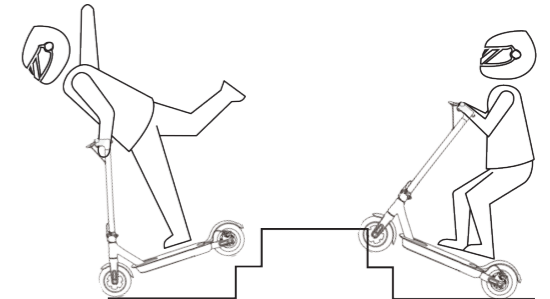

⊘ Do not try riding up or down stairs, and jumping over obstacles

8. Safety Instructions

The Hiboy S2 electric scooter is a leisure device. But once they're in a public area, they'll be seen as vehicles, subjecting to any risks faced by vehicles. For your safety, please follow instructions in the manual and traffic laws and regulations set forth by government and regulatory agencies.

- At the same time, you should understand that risks cannot be entirely avoided as others may violate traffic regulations and drive incautiously, and you're exposed to road accidents just as when you're walking or biking. The faster the scooter is, the longer it takes to stop. On a smooth surface, the scooter may slip, lose balance, and even result in a fall. Thus it is crucial that you use caution, keep proper speed and distance, especially so when you're unfamiliar with the place.
- Respect pedestrians' Right of Way. Try not to startle them while driving, especially children. When you ride from behind pedestrians, ring your bell to give them a heads-up and slow your scooter to pass from their left (applicable to countries where vehicles drive on the right). When you ride across pedestrians, keep to the right at a low speed. When you drive across pedestrians, keep the lowest speed or getting off the vehicle.
- Closely follow the safety instructions in the manual. Hiboy shall not be liable for any financial losses, physical injuries, accidents, legal disputes and other interest conflicts resulted from actions that violate user instructions.
- Do not lend your scooter to whoever doesn't know the operations. And when you do lend it to your friends, please take the responsibility to ensure he/she knows the operation and wears the safety gear.
- Check the scooter before every use. When you note loosen parts, low battery alerts, excessive wear, strange sounds, malfunctions and other abnormal conditions, stop riding.
- **WARNING – Risk of Fire – No User Serviceable Parts.**

9. Folding and Carrying

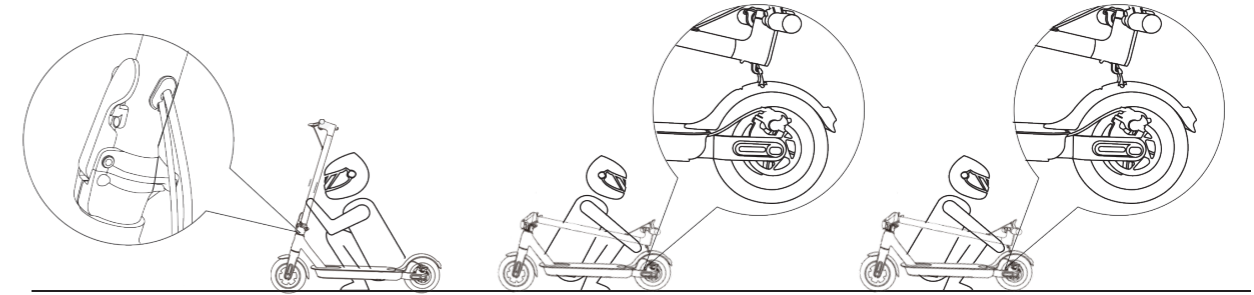

Make sure that the scooter's turned off. To fold, unlock the folding mechanism, and bend the handlebar stem to hook the buckle on the rear fender. To open, press the bell trigger to remove from the buckle, erect the handlebar and lock the folding structure.



Hold the handlebar stem with either one hand or both hands to carry.

10. Daily Care and Maintenance

Cleaning and storage

If you see stains on the scooter's body, wipe them off with a damp cloth. If the stains won't scrub off, put on some toothpaste, and brush them with a toothbrush, then wipe them off with a damp cloth.

Notes: do not clean the scooter with alcohol, gasoline, kerosene or other corrosive and volatile chemical solvents to prevent dire damage. Do not wash the board with a high-pressure water spray. During cleaning, make sure that the scooter's turned off, the charging cable is unplugged, and the rubber flap is closed as water leakage may result in electric shock or other major problems. When the scooter not in use, keep it indoors where it is dry and cool. Do not put it outdoors for a long time.

Excessive sunlight, overheating and overcooling accelerate the battery pack's lifespan.

Battery maintenance

1. Use original battery packs, use of other models or brands may bring about safety issues;
2. Do not touch the contacts. Do not dismantle or puncture the casing. Keep the contacts away from metal objects to prevent short circuit which may result in battery damage or even injuries and deaths;
3. Use original power adapter to avoid potential damage or fire;
4. Mishandling of used batteries may do tremendous harm to the environment. To protect natural environment, please follow local regulations to properly dispose used batteries.
5. After every use, fully charge the battery to prolong its lifespan.

Storage and Disposal

1. Please try to store the scooter in a cool and dry place between 14°F and 104°F. In extremely humid environments the interior of the scooter may suffer condensation or even water accumulation, which may damage the battery rapidly. Devices are not intended for use at elevations greater than 2000 m above sea level. Prolonged Exposure to UV Rays, Rain and the Elements May Damage the Enclosure Materials, Store Indoors When Not in Use.
2. In daily use, try to avoid recharging the scooter after completely exhausting the battery. If the battery is low, charge it as soon as possible.
3. Please charge the scooter every other month to preserve the battery.

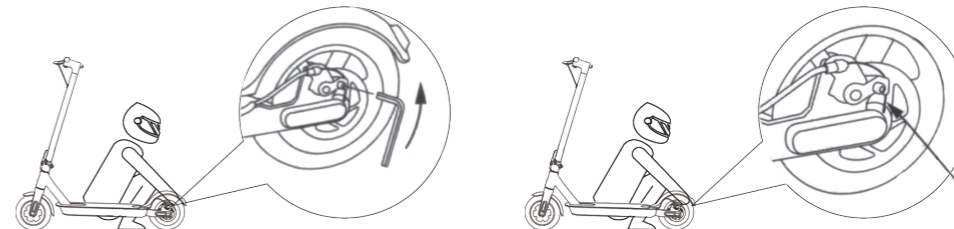

If the brake is too tight, use the allen wrench to loosen the screws on the caliper, and slightly send back the brake cable to shorten the exposed length, then tighten the screws. If the brake is too loose, loosen the screws, and slightly pull out the brake cable to lengthen the exposed length, then tighten the screws.

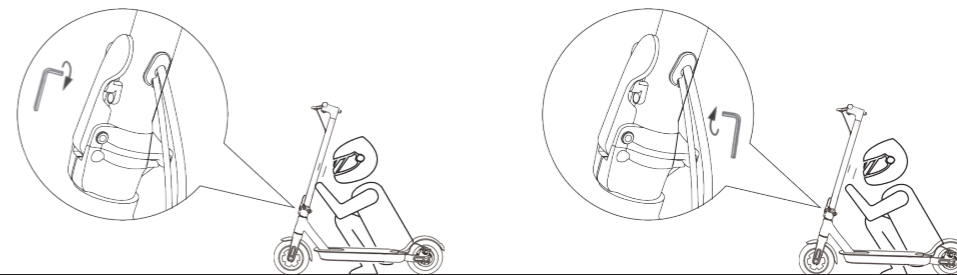

If the handlebar and its stem sway during riding, use the to tighten the screws on the folding mechanism.

11. Specifications

S2	Item	Electric Scooter
Dimensions	Unfolded (Length. x Width x Height)	45.7*17.0*47.2inch
	Folded (Length. x Width x Height)	45.7*17.0*19.3inch
Weight	Net Weight	31.9lb
	Load	44 ~ 260lbs
User	Recommended Age	16-50
	Max. Speed	19mph
Scooter	Max. Range	17mile
	Max. Slope	15°
	Operating Temperature	14-104 °F
	IP Rating	IP54
Battery	Voltage	36V DC
	Max. Charging Voltage	42V DC
	Capacity	7.5 Ah
Motor	Nominal Power	350W
	Input Voltage	110V ~ 240V
Charger	Output Voltage	42V DC
	Output Current	1.5A
	Charging Time	3h-5h

(1) The height of the body: distance from the ground to the highest end of the body.

(2) Description of the battery life: it is measured under the condition of full charge, a load of 150 lb, at 77°F , on a flat road without wind, and at a speed of 9.3mph. The real battery life will differ with different factors of the load, humidity, wind speed and operation habits.

(3) The maximum allowable weight shall be kept within 260lb (driver and objects included)in any case. Consider an extra weight of the clothes or other accessories with us during the trip and the gravity generated by speed, the scooter will not support it if this load limit is exceeded.

S2 Pro	Item	Electric Scooter
Dimensions	Unfolded (Length. x Width x Height)	45.3*16.5*47.6inch
	Folded (Length. x Width x Height)	45.3*16.5*19.3inch
Weight	Net Weight	36.3lb
	Load	44 ~ 260lbs
User	Recommended Age	16-50
	Max. Speed	19mph
Scooter	Max. Range	25mile
	Max. Slope	15°
	Operating Temperature	14-104 °F
	IP Rating	IP54
Battery	Voltage	36V DC
	Max. Charging Voltage	42V DC
	Capacity	11.4 Ah
Motor	Nominal Power	350W
	Input Voltage	110V ~ 240V
Charger	Output Voltage	42.5V DC
	Output Current	2A
	Charging Time	4h-6h

(1) The height of the body: distance from the ground to the highest end of the body.

(2) Description of the battery life: it is measured under the condition of full charge, a load of 150 lb, at 77°F , on a flat road without wind, and at a speed of 9.3mph. The real battery life will differ with different factors of the load, humidity, wind speed and operation habits.

(3) The maximum allowable weight shall be kept within 260lb (driver and objects included)in any case. Consider an extra weight of the clothes or other accessories with us during the trip and the gravity generated by speed, the scooter will not support it if this load limit is exceeded.

12. Instructions of Seat Assembly(Optional)

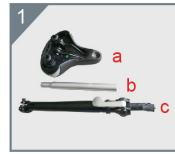

1. Seat components a, b, c



2. Insert b into a



3. Make b perpendicular to a, and tighten it with wrench



4. Insert the seat into c, and tighten the screw rod and press down the seat clamp as shown in the figure.



5. The seat assembly is completed

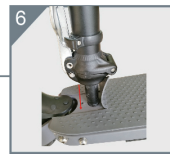

6. Insert the assembled seat into the hole on the scooter.



7. Open the safety ring.



8. Pull the fixed handle and put the seat down



9. Tighten screw with a hexagonal wrench.

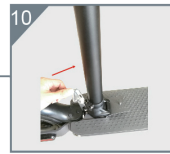

10. Fasten the fixed handle.



11. Lock the safety ring.



12. Seat assembly completed.

* The seat is not included, please purchase separately from hiboy store*

13. Limited Warranty Statement

30 DAY SATISFACTION GUARANTEED RETURN POLICY

If you are unsatisfied with your purchase, Hiboy's return policy allows you to return the product purchased on the Authorization channel within 30 days counting from the date of receipt of shipment, and request a refund from the Authorization channel for any reason. Note: Express shipping cost is non-refundable.

For the return request, Hiboy is not responsible for lost packages due to the carrier, or products received that cannot be verified. Received products that have damage determined to have been caused by the end-user may be subject to denial of the return request.

TO QUALIFY FOR A REFUND, ALL THE FOLLOWING CONDITIONS MUST BE MET:

1. A Return Merchandise Authorization (RMA) must be requested from Hiboy within 30 days from the date of receipt of shipment. To request an RMA, contact Hiboy Service Team at us.support@hiboy.com.
2. The cost of return shipping will be borne by the customer.
3. For warranty service, please keep your receipt and/or invoice to validate proof of purchase.
4. Returned product must be in good physical condition (not physically broken or damaged).
5. All accessories originally included with your purchase must be included with your return.
6. If you return a product to Hiboy, (a) without an RMA from Hiboy (b) without all parts included in the original package, Hiboy retains the right to refuse delivery of such return.

LIMITED PRODUCT WARRANTY

Hiboy warrants the original purchaser that your Hiboy product shall be free from defects in materials and workmanship under normal use for a period aforementioned. Hiboy does not warrant the operation of the product will be uninterrupted or error-free. Hiboy is not responsible for damage arising from failure to follow instructions relating to the product's usage.

REMEDIES

If a hardware defect is found and a valid claim is received by Hiboy within the Warranty Period, Hiboy will, at its option and to the extent permitted by law, either (1) repair the product at no charge, using new or refurbished replacement parts or, (2) replace the product with a new or refurbished product. In the event of a defect, to the extent permitted by law, these are your sole and exclusive remedies. Shipping and handling charges may apply except where prohibited by applicable law. This Limited Warranty is valid only in the jurisdictions where the products are sold by www.hiboy.com, and is valid to the extent permitted by the applicable laws of such jurisdictions. Any replacement hardware product will be warranted for the remainder of the original warranty period or thirty (30) days, whichever is longer, or for any additional period of time that may be applicable in your jurisdiction.

HOW TO OBTAIN WARRANTY SERVICE

A Warranty Service Order must be requested from Hiboy within Warranty Period from the date of receipt of shipment. To request a Warranty Service Order, contact Hiboy Service Team us.support@hiboy.com.

To obtain warranty service, you must deliver the product, in either its original packaging or packaging providing an equal degree of protection, to the address specified by Hiboy. In accordance with applicable law, Hiboy may require the customer to furnish proof of purchase details and/or comply with registration requirements before receiving warranty service. period or thirty (30) days, whichever is longer, or for any additional period of time that may be applicable in your jurisdiction.

LIMITATION OF DAMAGES

Except to the extent prohibited by applicable law, Hiboy shall not be liable for any incidental, indirect, special, or consequential damages, including but not limited to loss of profits, revenue or data, resulting from any breach of express or implied warranty or condition, or under any other legal theory, even when Hiboy has been advised of the possibility of such damages. Some jurisdictions do not allow the exclusion or limitation of special, indirect, incidental or consequential damages, so the above limitation or exclusion may not apply to you.

Question & Answer

1. What if the E-Scooter arrived missing accessory or broken part?

A: Please take a photo and send to Hiboy Support Team by sending email: us.support@hiboy.com
And Hiboy Support Team will reply you soon and send correct accessory or part replacement.

2. How to attach the seat?

A: There are some Hiboy scooter video on Amazon or YouTube.
And you may follow the video to attach correctly.

3. Is that possible to replace some components for example the rear cover?

A: Yes, please take a photo and send to Hiboy Support Team by sending email: us.support@hiboy.com
And Hiboy Support Team will reply you soon.

4. Why the screen returns an error code like E10 or E16?

A: Please contact Hiboy Support Team to remove the error code.

5. Is there an Android/iOS app? If so, what does it do?

A: Yes, the app is Hiboy S2 App.

Simply pair Hiboy Electric Scooter via Bluetooth and use the app to view current speed, remaining power, and other real-time riding statistics. Firmware updates ensure that you always have the best riding experience possible.

6. What if the rear brake of the scooter doesn't work well?

A: You may please contact us for instructions of brake adjusting, or search "How to adjust rear brake of scooter" in YouTube for tutorial video as well.

Contact Us

Contact us if you experience issues relating to riding, maintenance and safety, or errors/faults with your Hiboy S2/S2 Pro

HIBOY LIMITED

12178 4TH STREET. RANCHO CUCAMONGA. CA 91730 US

E-mail Service: us.support@hiboy.com



@Hiboy_Official



hiboyus



@HiboyUS



HiboyUS



www.hiboy.com