

Puppet theater

Your children's imagination will come alive while building and playing with the puppet theater. Just think of all the stories they can share!

Whether a well-loved fable, or an original work, encourage them to bring characters and narrative to life for an audience.



You will need:

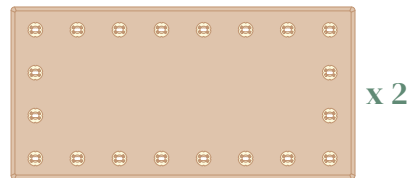
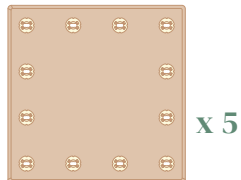

Step 1

STEM Tip
Ages 3-5 Align the two squares so the holes line-up. How many holes are along the edges? Are the boards the same size?



Step 2

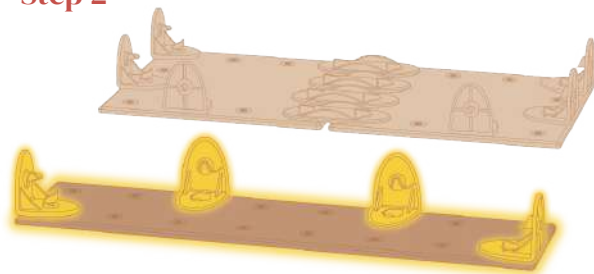

Step 3

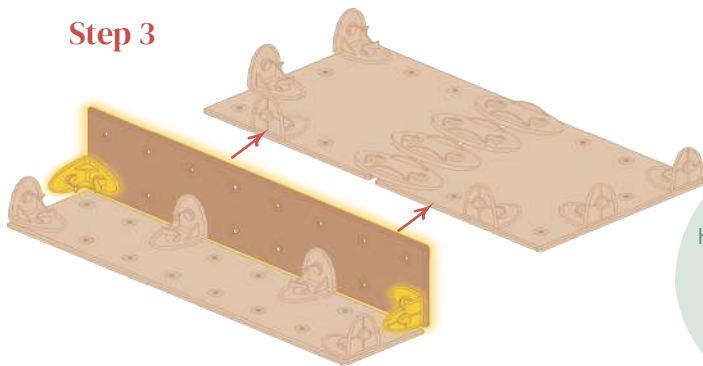

STEM Tip
Ages 5+
 How can two squares be exactly the same length as the skinny rectangular board?
 (Answer: Create a gap.) Does the 180-degree bracket help create that gap?

Step 4

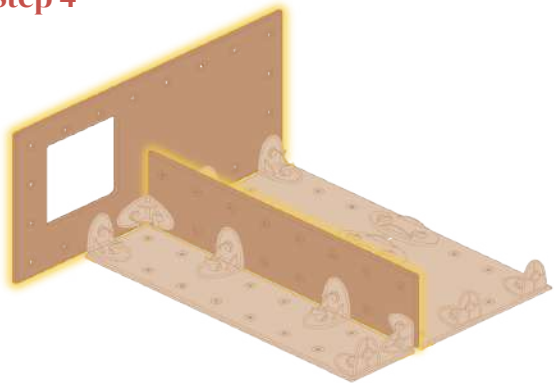

Step 5

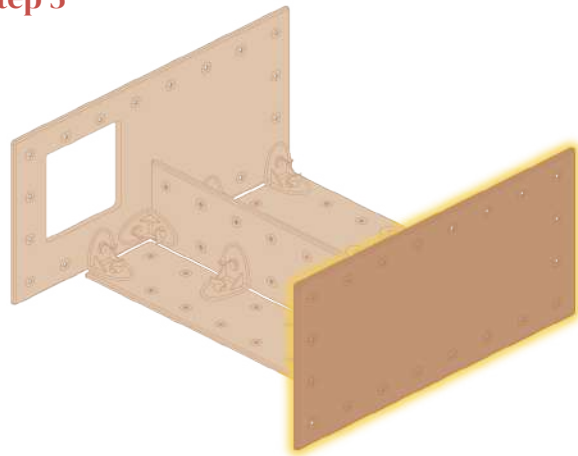

Step 6

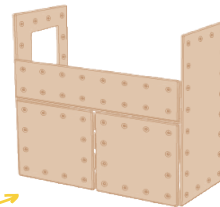
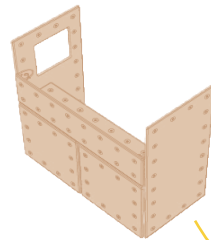
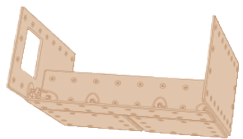

Tip
Remember
to get help lifting
the puppet
theater upright!

Step 7**STEM Tip**
All Ages

Make sure the spine of the 90-degree connectors are parallel to the edge of their boards before lowering the bigger board into place.

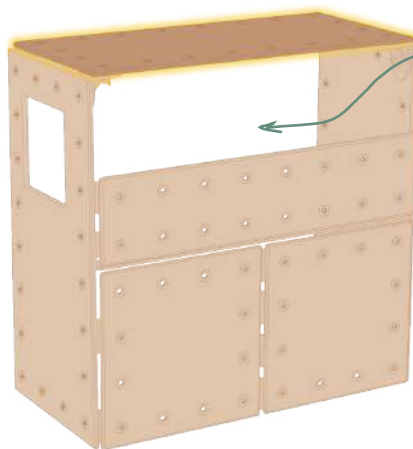
Step 8**STEM Tip**
Ages 5+

What board fits in this gap? Do two long skinny boards have the same "area" as the two squares below? What is "area"? Talk to an adult to learn more about the idea of "area".

Step 9



Step 10

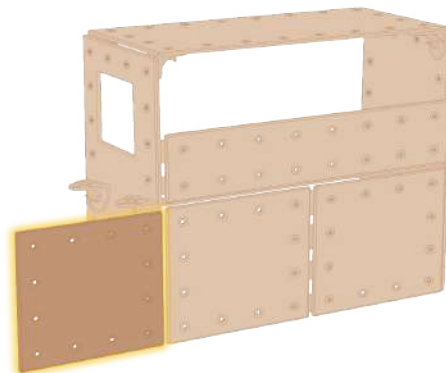

**Step 10
Rear View**

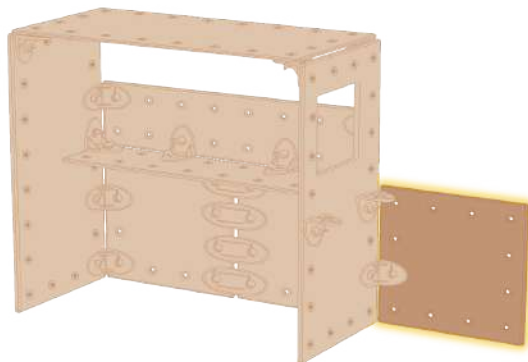

Step 11

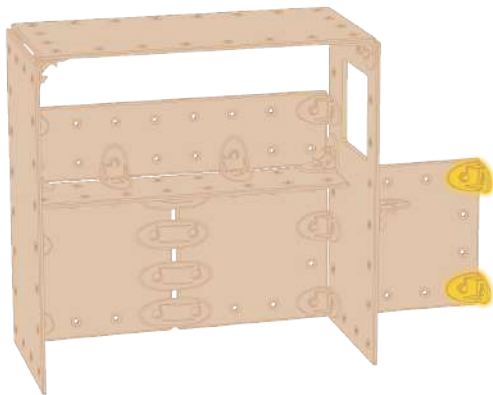

Step 12



Tip
Use
second and
fourth holes

Step 13



STEM Tip
All ages

How many connectors are there? How many are the same?

STEM Tip
Ages 5+

Which connectors are pulling (tension) and which are pushing (compression)?

How will you use the shelf? What will you use the box for? Adults, let your child take the lead. Kids often surprise adults with their thoughtful and creative ideas!

Step 13 Front View

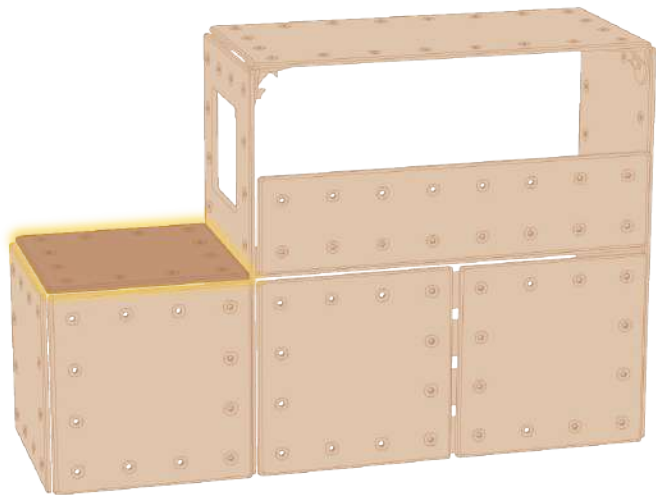

Step 14

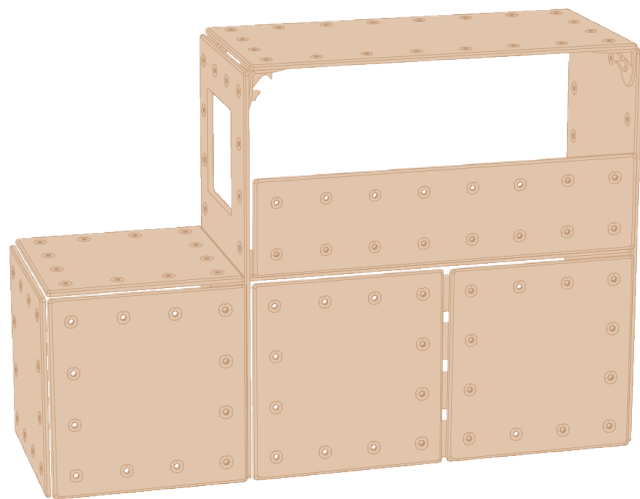

Taking Care with WunderNook®

- All Creations in this guide are tested and approved by a CPSC-approved third-party safety lab.
 - Adult assembly and supervision is required for our younger users.
 - Do not climb, stand or sit on unassembled panels or Starter Collection Creations.
 - Store unassembled panels flat, ideally in a WunderNook tote bag.
 - Keep all parts dry.
 - Keep product away from an open flame.
- Only use WunderNook decals, as those manufactured by others may damage the finish on the panels.

Read about our system and review general building tips before getting started.



WARNING:
CHOKING HAZARD--Small Parts
Not for children under 3 years



WARNING:
Toy intended to be
assembled by adult

What's Inside the Box

Core & Classic Collections

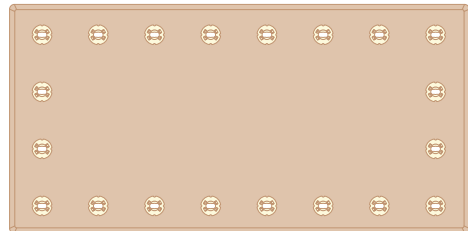

x2



x2

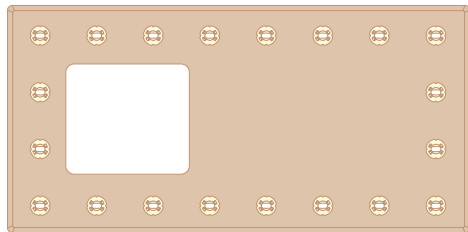

x1



x24



x4

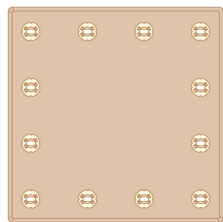

x6

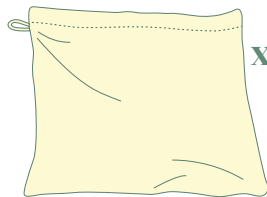

x1



x2

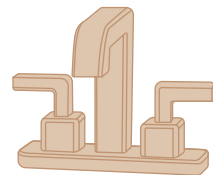

x1

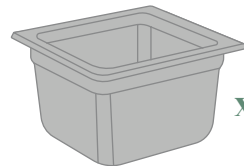

x1

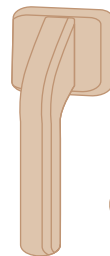

x2



x2

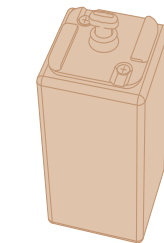

x4



x2 sets

What's Inside the Box

Classic Collection Extras

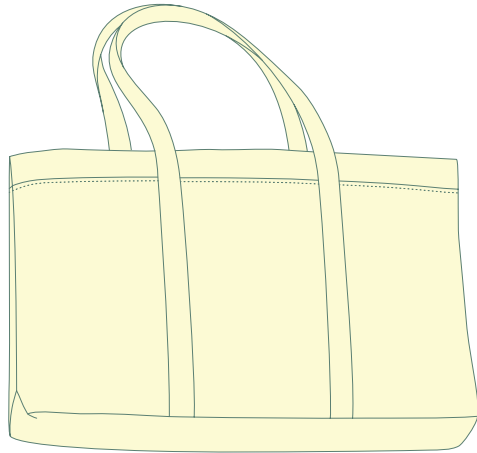

x1

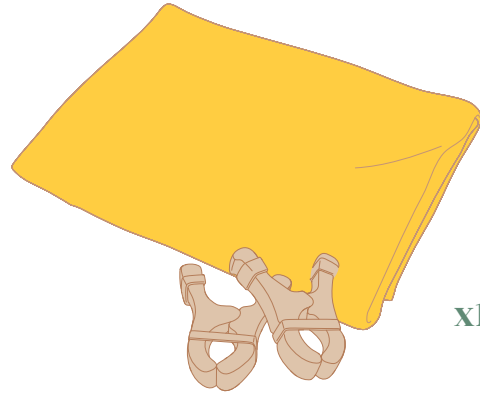

x1



x4



x1



x1

About Our System

Our proprietary modular system of panels and connectors gives children the flexibility to transform their play space as often as they want -- all without tools. The holes set WunderNook apart from other fixed pretend play structures. They signify possibility and flexibility, and communicate to children how the panels can be used.

Our unique system is made up of panels with special holes and three types of connectors

Panels & Holes

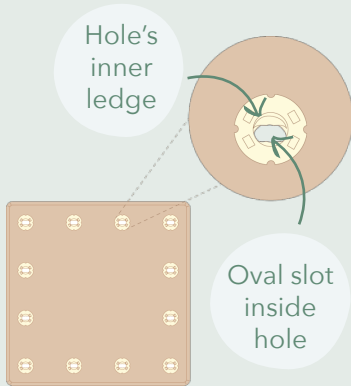

Connectors

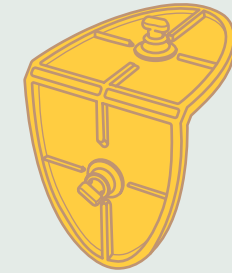

To lock, twist the knob 90 degrees.

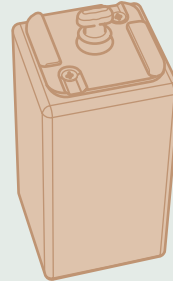

To lock, twist the entire part 90 degrees.

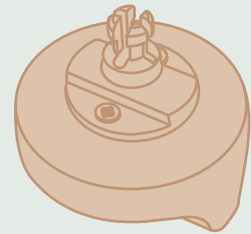

Align snap with oval slot and push to snap.



General Building Tips

Take a moment to get familiar with our building tips alongside your children. They'll be building masters in no time! Hands-on learning and experimentation facilitate children's growth and development better than anything.

Building options for all ages

Younger children need an adult to assemble the Creations, but they can participate in each step of the build. Encourage them to sort connectors by angle, count holes for connector placement, align panels, twist knobs, and decide where to put accessories like handles and decals. Older children will demonstrate the ability to do more independently, with you, or with a friend. Read on for details on what you can expect at different ages.

Overcoming challenges leads to deeper learning

Learning is often fun, but it can be frustrating at times too – but don't worry, overcoming frustrations leads to a more meaningful sense of accomplishment for your child and a more permanent grasp of the STEM learning.

Lay out & organize parts before building

Your kids will build more easily if their workspace is uncluttered and parts are sorted by angle and feature. Organization is a great life skill to develop early and children will make observations more easily while building.

Start all builds on level ground

A flat, stable surface allows your kids to align panels and ensures the panels remain aligned. This makes it much easier to insert and twist connector knobs.

Let the ground support the weight

When building, orient the design to have the largest panels lying on the floor during the build, even if that's not the Creation's final position. It's easiest, and safest, to let the ground support the weight of the panels while building, and then move the Creation into a standing position. Kids should get the help of an age appropriate friend or adult when lifting it.

Bonus: This helps develop spatial reasoning!

Align the holes

Align the holes to make sure they are on the same X or Y axis. Take a moment to talk about vertical and horizontal planes with your child.

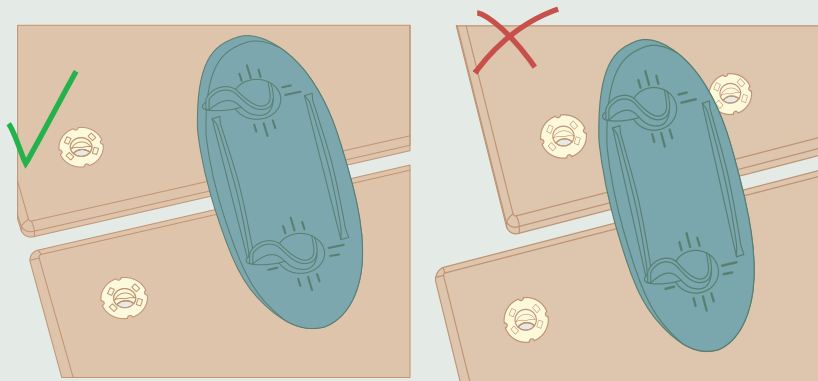

Disassemble in the opposite order of assembly

When your children are ready for their next building challenge, the safest way to disassemble the Creation is to reverse the steps they took to build it.

Observe how connector knobs lock into holes

Before starting any Creation, have your child look at the oval slot inside the hole. Then look at the t-shaped end of the connector knob's post. Can your child figure out how the t-post fits through the oval slot? Can he or she then figure out how it locks? Once locked, does your child see that an additional 90-degree twist will unlock the connector?

Hint: the lined grooves on the face of the connector are a visual guide for 90-degree rotations.

Prepare t-posts before adding panels

When building, before lifting another panel into place, orient the connectors' t-posts to match the direction of the holes' oval slots. Then encourage your kids to make sure all t-posts are fully inserted into the oval slots before they twist the knobs.

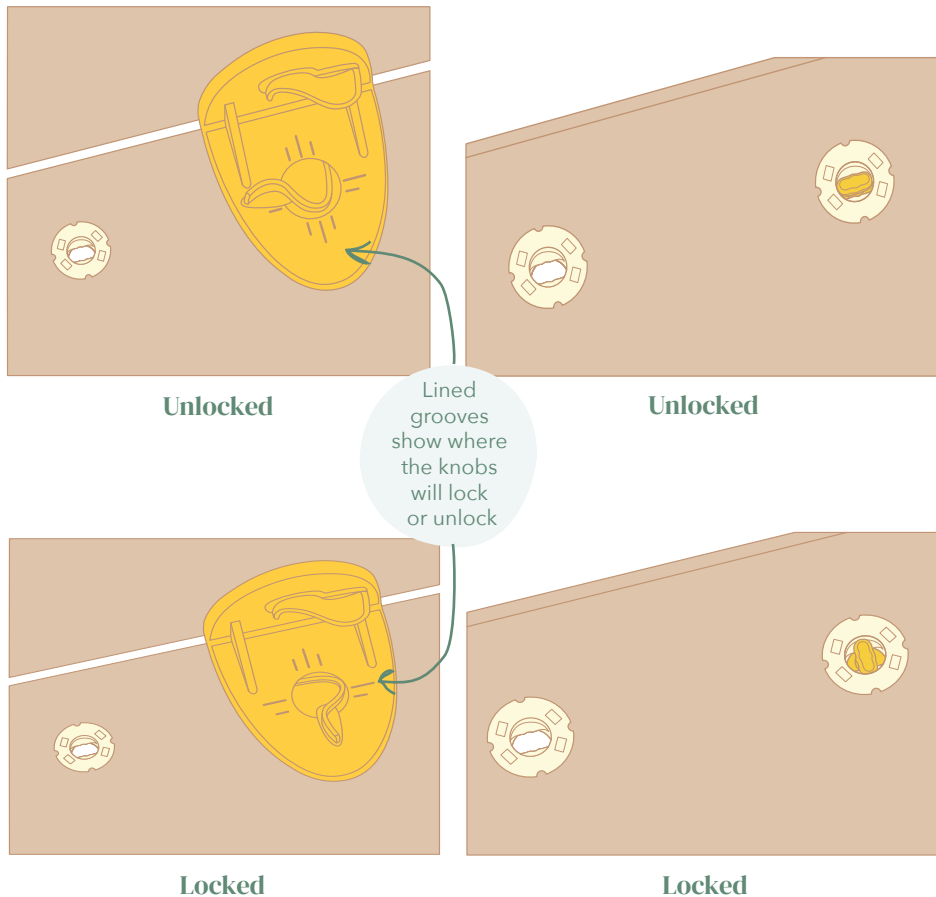

Check alignment before twisting

Have your child align a connector's t-post to the hole's oval slot, insert it all the way, until it's against the hole's inner ledge, and twist the connector knob to lock it into place. Then practice twisting the knob 90 degrees to unlock it. Now have your child try to **gently** twist the knob **without** inserting it all the way into the hole. Take notice together of how the resistance feels different. Caution your child against breaking parts by forcefully twisting too hard when parts aren't aligned.

WunderNook parts are designed for years of play, but they should be used in the proper way. When connecting parts, your child should feel a little resistance, but if your child feels too much, check alignment of the parts to avoid breaking any components.

Extra tip: Wood is a living material and can swell or warp depending on the humidity in your home. If a knob is especially hard to turn, but is fully inserted, your child can try achieving alignment by pressing the tip of the connector and wood panel together to ease resistance while turning the knob.

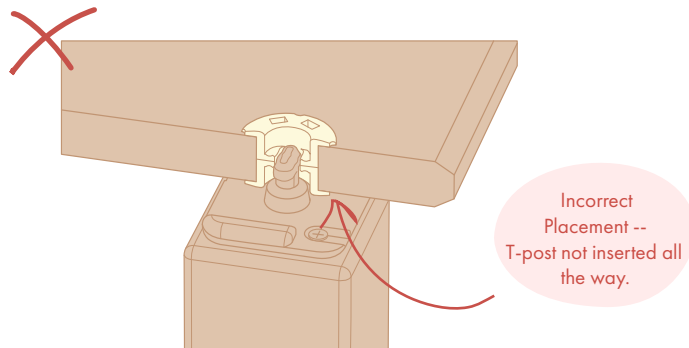
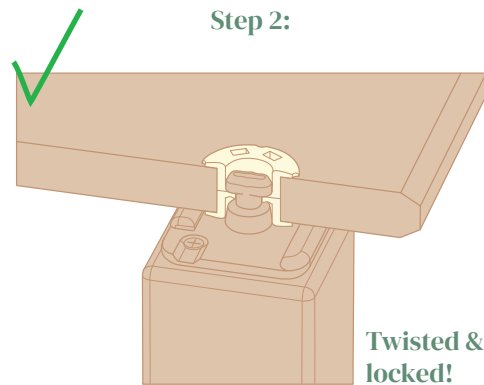
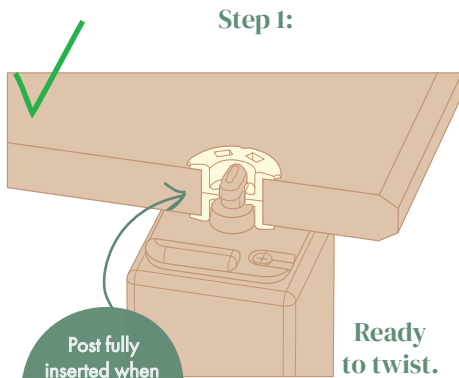

Get familiar with the snap

Hold a wooden stove knob or the faucet upside down, and ask your child to squeeze the four small heads of the snap together. Notice how it's easier to squeeze them together from certain angles. Can your child see when it is easiest, the four heads make an oval shape that pairs with the hole's oval slot?

Hint: to achieve the oval shape by squeezing from the sides, the screws will be at a 45-degree angle from the long side of the oval, as shown below.

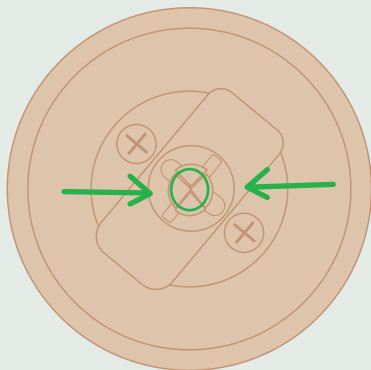

Align snaps with hole's oval slot

The snap will work at any rotational angle, but you will feel slight variances in resistance. What is important is that the prongs are aligned with the hole, and are not jammed against the inner ledge of the hole.

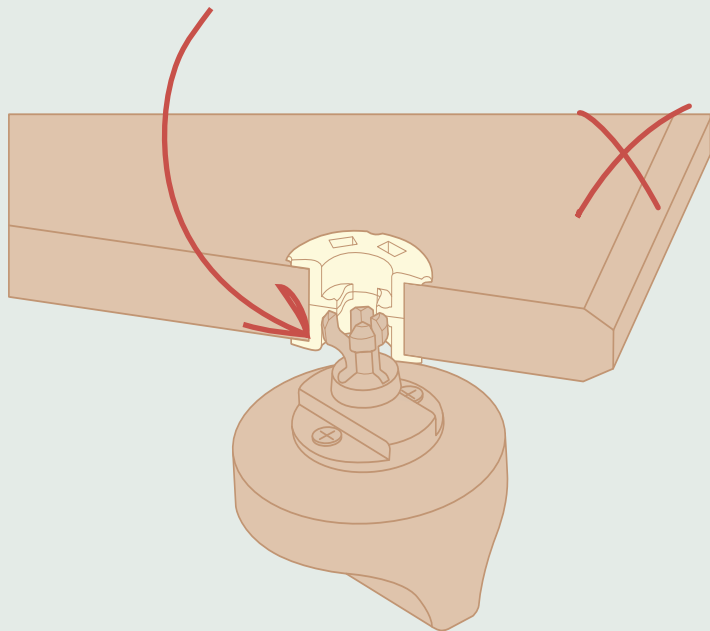

Look for parallel lines

Have your child look at the direction of the oval slot inside the hole, and the direction of the t-post on the foot. How does the t-post need to be aligned to insert it into the slot?

Show your child what a locked foot looks like. From one side you will see the t-post perpendicular to the length of the oval slot. On the other side, you will see parallel lines between the foot's edge and the edge of the board.

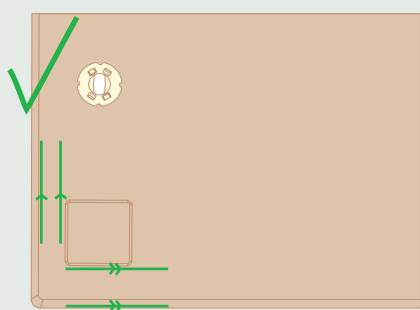

Parallel lines

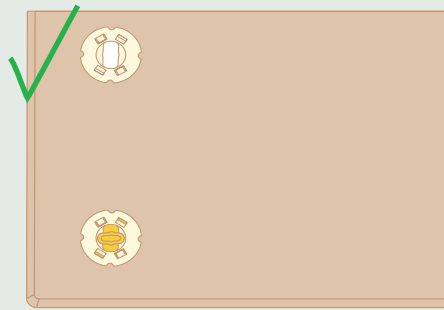

Locked, perpendicular t-post

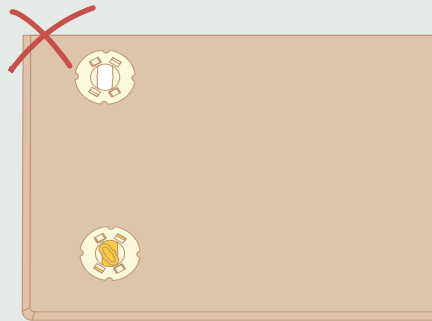
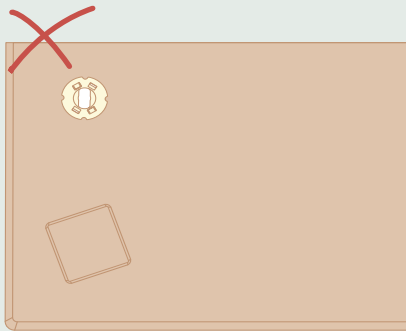

Connector placement builds strength

When building a Creation, take the time to review connector placement with your child. The position of connectors in the instructions is purposeful. Often, there are patterns of symmetry. But there are cases where the connectors aren't perfectly symmetrical and it's interesting to consider why.

Hint: in many cases it's because a hole needs to be reserved for a handle, knob or hinge.

Bonus: being able to plan ahead is a great pre-coding skill!

Hint: Some Creations have connectors facing opposite directions to build both tensile and compressive strength.

Attach single-magnet door latch first

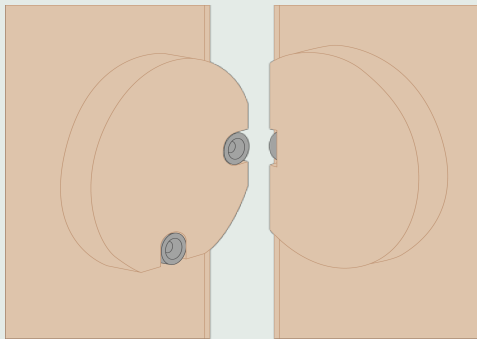

Our door latches give you flexibility to orient your hinges in a vertical or a horizontal position on both the square and rectangular panels. Attach the single-magnet door latch to the rectangular board first if using one, then determine the hole orientation for the handle on the door, and lastly, attach the double-magnet latch so it lines up with the first latch's magnet. Any guesses why the order matters if using a rectangular panel?

Hint: you can change the orientation of the oval slots on the square panels by rotating the panel, but you can't with the rectangular panels.

Position connector's spine parallel to the panel's edge

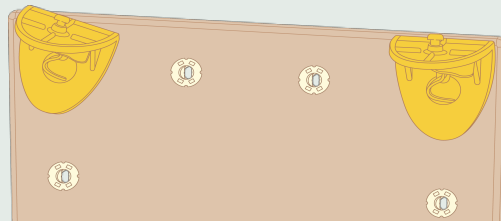

Creations come together best with proper connector alignment; always position the connector spine parallel to the panel's edge.

Feeling unusual resistance when turning the knob?

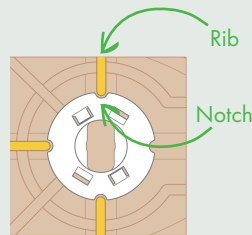

If the connector isn't flat against the board, first make sure its spine is parallel to the edge. It could be that the ribs on the back of the connector need to slide into the notches of the hole's perimeter. If all is aligned, press the tip of the connector against the board while turning the knob.

Abbreviated Educational Guide

WunderNook is on a mission to enrich the wonder of childhood, while simplifying the journey of parenthood. We've developed an Educational Guide to help you, the parent, identify and seize developmentally appropriate learning opportunities as your child builds and plays. The abbreviated Educational Guide below gives an overarching view, which complements the STEM and pretend play tips in the Creation Guide's instructions. Follow the QR code below for the complete guide:



Ages 3-4

Imaginations soar at this age; children will show interest in problem solving and exploring without inhibition. Address their observations, take time to answer their questions, and encourage them to work on fine and gross motor skills. An adult or older sibling will do the building, but kids of this age will take satisfaction in impacting their environment by choosing where to place the decals, knobs, handles and faucet. This is a good age to introduce the twist & lock system.

Bonus: Twisting the knobs is a great hand strengthening exercise.

When the Creation is complete, a child in this age range will play alone or alongside others, but will likely not yet engage in joint play or play with a common purpose.

Ages 5-6

At this stage, children will start building with a friend, or an adult, or even independently. A kid may even think of new Creations at this stage as well. Please share your child's suggestions with us. We want your new ideas to get tested and approved by an independent safety lab for you and others to enjoy!

Math concepts such as perimeters and ratios start to become tangible, and trial and error efforts illuminate engineering concepts such as balance, gravity, symmetry, and more. Experimentation will lead to sheer delight... as well as frustration. Help your child build resilience and navigate the ups and downs through encouragement and giving helpful hints.

When the Creation is complete, you will observe cooperative play between children. They will learn about social dynamics and will embrace hands-on learning. The WunderNook Creations will come alive with joint activities between friends, siblings and adults.

Ages 7-8

Children in this age group tie imagination to the real world and use language, arts, and creativity to make their thoughts come alive. They will follow the step-by-step instructions to build most Creations independently, and intuitively understand the need to align holes. They may also use language to express next steps or what's working (or not working), and deduce the importance of different angled connectors. As an example, a kid may learn that right angles are necessary to create a level surface in a Creation. They will also adapt and experiment on Creations they know well. Encourage and embrace their innovative thoughts and work, while ensuring the structures are safe.

During pretend play, story lines may become quite complex. Countless activities can support play around each WunderNook Creation. Please see our blog (www.wundernook.com/blog) for ideas regarding props and activities. Children may also plunge into play and games with order, rules or social constructs. For example: *"First we need to collect all of the materials, then we need to write invitations to attendees, then we need to practice our performance..."* etc.

Ages 9+

Watch as your older child grows with WunderNook and becomes a teacher to a younger sibling or other kids. Be sure to post Creations to our social media accounts and email us at hello@wundernook.com to share your child's thoughts and suggestions.

Submissions will be considered for official testing by a CPSC-approved third-party safety lab. We are always expanding our catalog of WunderNook Creations and value builder feedback!

Please remember that only the Creations in this guide (and other subsequent guides) have been safety tested. The WunderNook Creations Guide will tell you if your child has solved the puzzle and has landed on a Creation with the connectors placed in the locations approved by an CPSC-approved child safety testing lab. Submissions will be considered for official safety testing. We are always expanding our catalog of WunderNook Creations and and value builder feedback!