

Micro RC Foamy Biplane Stearman PT-17

Instruction Manual

E25

飞行前的建议 PRE-FLIGHT CHECKS

- 安装舵机前，请先将舵机通电让舵机中心点回中，以便能更好的调试舵面。
- Check/adjust servo centering, in order to adjust the control surface better.
- 初次启动电机，您需要确认电机旋转的方向以适配您的机型。
- Double-check the spinning direction of motor at first usage, and sure it's suitable for your model.
- 请将重心 (CG) 调整至说明书所述位置并尽量靠近。如果有需要，您可以增加机头或者机尾的重量，以确保机体有更好的飞行姿态。
- Set the center of gravity (CG) at the position that manual already marked out. If necessary, add weight to the nose or tail to ensure the best flight performance.
- 检查机身内部，确保所有设备正常连接；检查机身表面，包括但是不限于蒙皮，固定螺丝，舱盖，座舱罩等位置。
- Double-check the inside of the fuselage, make sure all the equipments are correctly connected; Check the heat-shrink covering material's surface, Make certain all screws, bolts, cabin and canopy remain secure.
- 在飞行前，请检查您电池情况，若有低电压，电池损坏等情况，请您停止操作并马上更换电池。
- Take great care when connecting/disconnecting the battery, pls replace the battery immediately once found low voltage or damage to battery.
- 机身内部设备连接的方式，会和您的收发设备有关，在一些功能更多的收发设备上，您可以通过设置简化机身内部设备的连接。详情请查看您的收发设备以确认是否满足您需要的功能。
- The way the internal devices of the fuselage are connected will be related to your transmitter-receiver device. For those transmitter-receiver devices with more functions, you can simplify the connection of the internal devices of the fuselage. Check your device for details to see if it meets the features you need.
- 动力设备和收发设备第一次配对时，可能需要设置油门最大行程，请您自行设置。
- When the power system and transmitter-receiver device are paired for the first time, you may need to set the maximum stroke of the throttle. Please set it yourself.

注意事项 SAFETY PRECAUTIONS

- 这个产品不是玩具，而是一个复杂的具有难度的飞行器。您和您身边人的安全取决于您如何操作它，您需要了解相关知识，并谨慎操作。禁止没有成人陪伴的儿童独自操作该设备。不适合14岁以下人群使用。再次强调，这不是一个玩具。
- This product should not be considered a toy, but rather a complicated and sophisticated flying model. Your safety depends on how you use and fly it, If not correctly operated, could cause injury to you or your family members. Children must be accompanied by an adult at all times if operating this product. Not suitable for children under the age of 14. THIS IS NOT A TOY.
- 不要在机场，军事基地，居民区或其他任何受限制的地方飞行。
- Do not fly around some restricted location like airports, military bases, residential areas, etc.
- 您需要对发射机进行距离检查，以确保没有收到任何干扰。
- You will need to range check the transmitter to be sure you are not experiencing any interference.
- 始终保持先打开发射机后打开接收机，先关闭接收机后关闭发射机的步骤。
- Always turn on the receiver last after turning on the transmitter and shut off the receiver first before turning off the transmitter.
- 如果您是初学者，建议您在有经验玩家的协助下调试和飞行。
- If you are only a beginner to the radio control model flying, do not attempt to fly your model without any assistance or advice from advanced expert fliers.
- 请将相关物品放置在孩子们够不到的地方
- Keep relevant items out of reach of children.
- 这个设备的设计已经超过我们正常使用所需要刚性要求，但若您需要以超出我们推荐的动力飞行时，请合理控制动作幅度并适当增加机体强度。
- This product has been flight tested to meet or exceed our rigid performance and reliability standards in normal use, if you plan to perform any high-stress flying, you are solely responsible for taking any and all necessary steps to control movement range and reinforce the body strength.
- 您的设备中可能包括一些玻纤和碳纤维雕刻的部件，这些纤维部件所带的粉尘可能会引起眼睛，皮肤的不适，请您在需要的时候带上护目镜或者防尘服。
- This product may include some fiberglass and carbon-fiber reinforced plastic parts, which may cause eye and skin discomfort, pls wear the goggles or dust-proof clothes when needed.
- 因航空运输安全管理，您收到的产品可能没有清单中出现过的胶水，请您理解无法发送胶水给您的原因。您可以在当地文具店很方便的购买到您所需要的胶水。
- Due to air traffic safety control, the products you receive may not have the glue that appears in the list. Please understand and purchase the glue you need at your local stationery store.



飞行参数 Specification

翼展: 450mm
机长: 413mm
起飞重量≈55g

Wingspan: 450mm
Length: 413mm
Flying Weight≈55g

推荐配置 Suggested Equipment

推荐马达: MM1104 3700KV
推荐电调: 5A 2S
推荐舵机: 1.7g * 3pcs
推荐桨叶: 4inch Prop
推荐电池: 2S 150mAh
推荐通道≥4CH

Suggested Motor: MM1104 3700KV
Suggested ESC: 5A 2S
Suggested Servos: 1.7g * 3pcs
Suggested Propeller: 4inch Prop
Suggested Battery: 2S 150mAh
Radio≥4CH

工具 Tools Needed



KIT

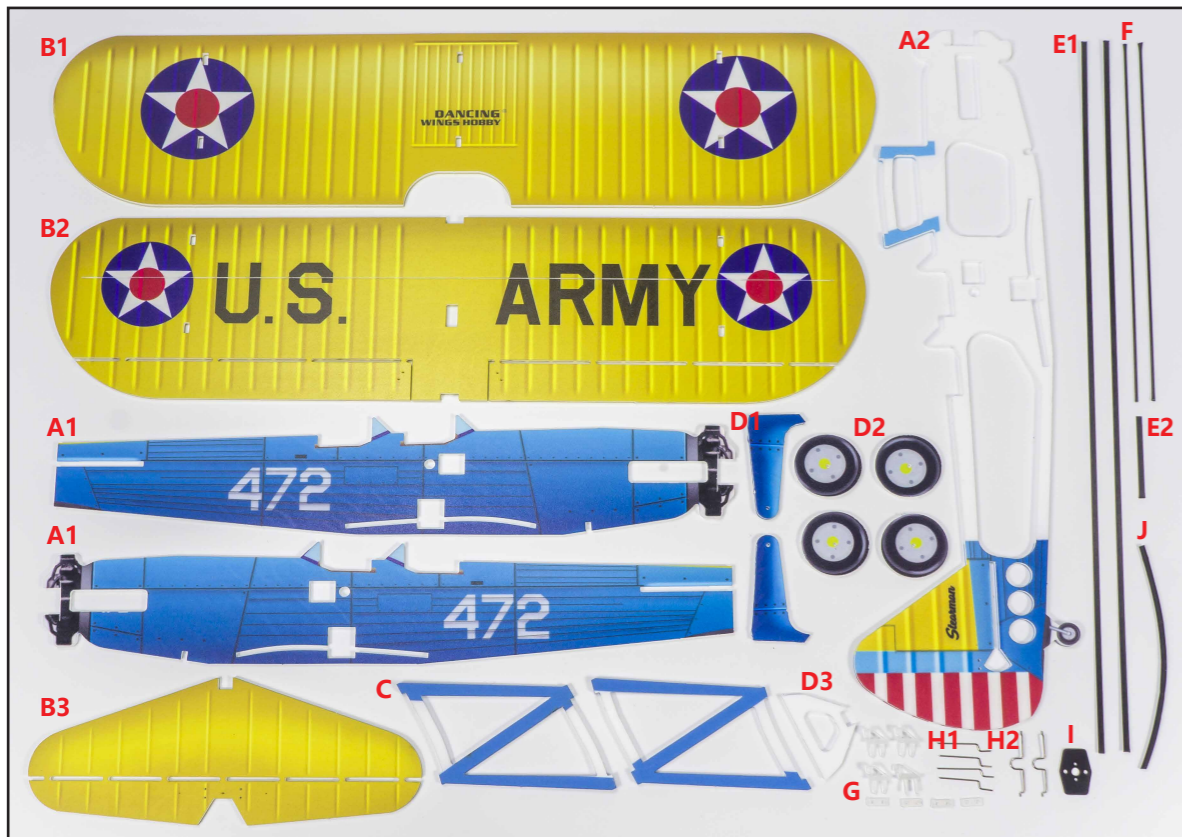

- A1-2: 机身 Fuselage
- B1-2: 机翼 Wing
- B3: 水平尾翼 Horizontal Tail
- C: 机翼支架 Wing Struts
- D1-3: 起落架, 轮子 Landing Gear; Wheels
- E1-2: 碳片 Carbon sheet
- F: 碳杆 Carbon Rod
- G: 舵角 Servo Horn
- H1-2: 钢丝连杆 Steel Wire Linkage
- I: 马达座 Motor mount
- J: 热缩管 Heat-shrinkable Tube

配件图仅供参考, 您收到的实物可能因为修改/优化的原因导致与图片略有不同。
Photos shown here just for reference, the product you received maybe slightly differ from the photos due to continuous improvement on products.

机身拼装 Assemble the Fuselage

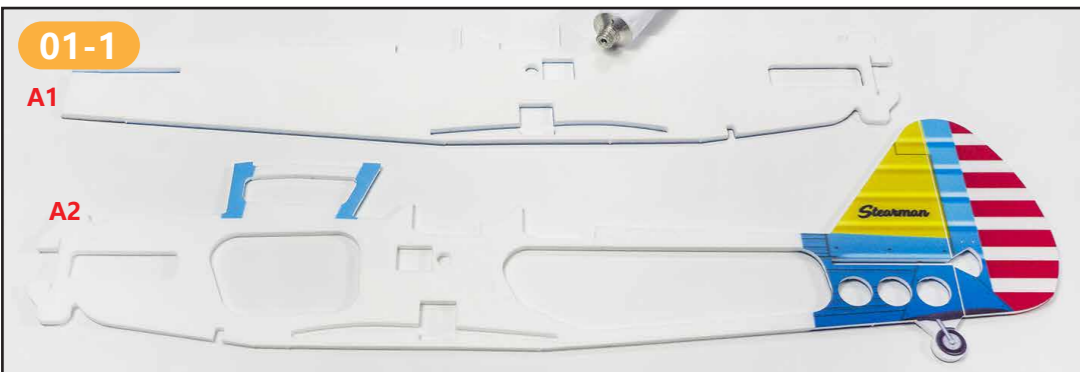

在两片A1的反面均匀涂抹泡沫胶。
在A2的两侧均匀涂抹泡沫胶。
Spread foam glue evenly on the reverse sides of the two pieces of A1.
Spread foam glue evenly on both sides of A2.

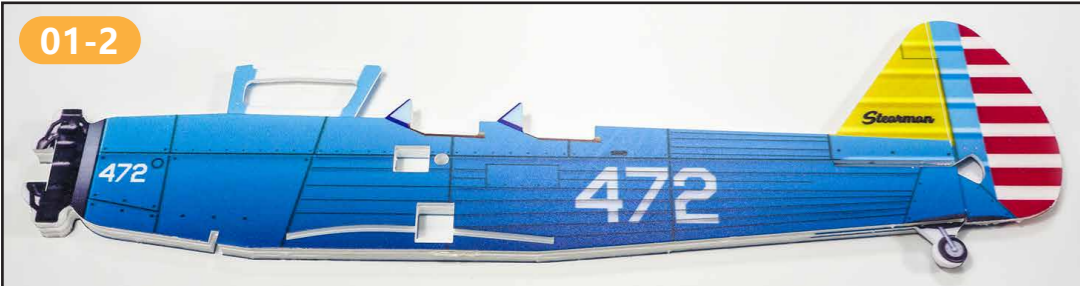

把涂好胶水的A1粘到A2的两侧, 粘贴时对齐边缘及各对应的空位。
Glue the glued A1 to both sides of A2, and align the edges and corresponding spaces when pasting.

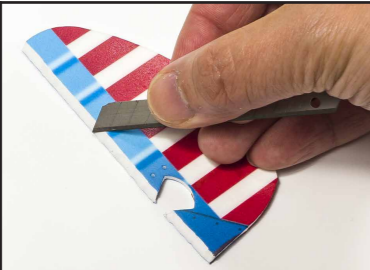

把转向舵从机身切下, 用模型刀切割转向舵与机身连接处, 切出45度斜面。
Cut the steering rudder from the fuselage, use a model knife to cut the connection between the steering rudder and the fuselage, and cut a 45-degree slope.

机翼拼装 Assemble the Wing



在下机翼B2底面预留槽内嵌入E1碳片, 并用泡沫胶把碳片粘固在槽内。
Insert the E1 carbon sheet into the reserved groove on the bottom of the lower wing B2, and fix the carbon sheet in the groove with foam glue.

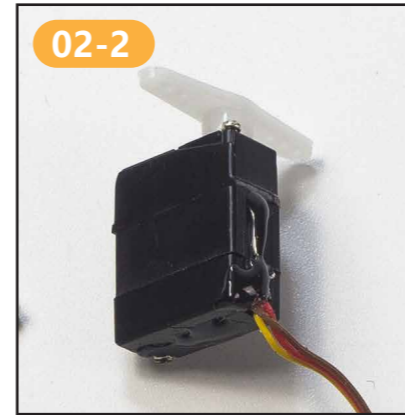

把舵机通电回中, 并安装一字型舵臂。然后切掉舵机支架。
Power on the servo back to the center, and install a flat servo arm. Then cut off the servo bracket.

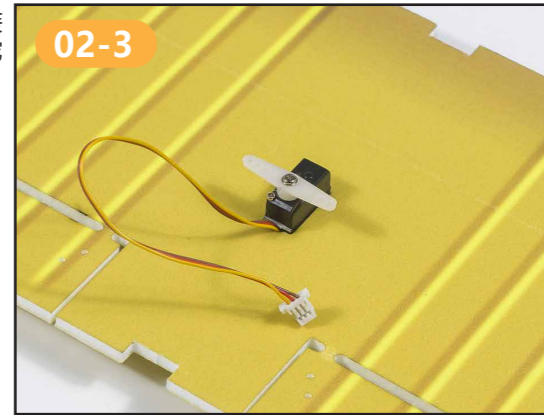

把02-1步骤粘好的机翼翻转, 装入舵机并把舵机线放置到正面。(如左图安装)此处舵机不要粘。
Turn over the wing glued in step 02-1, install the servo and place the servo line to the front. (as shown on the left) Do not paste the servo here.

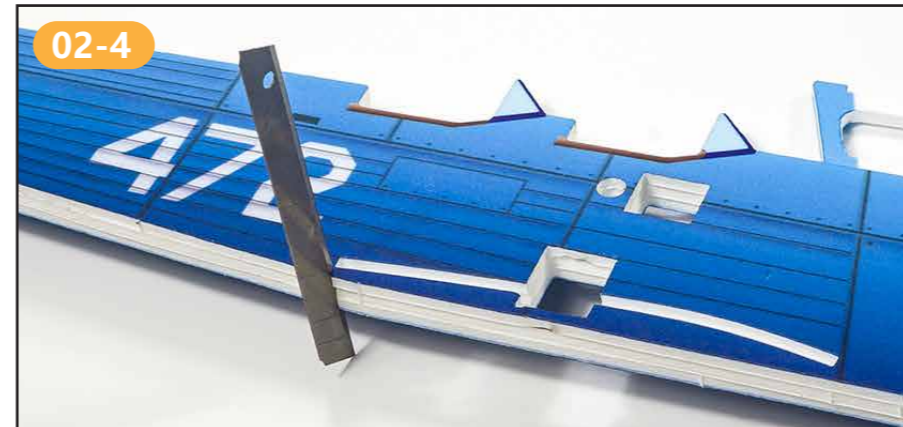

用模型刀在机身下机翼安装位置切开一个小口。
Use a model knife to make a small cut in the wing installation position under the fuselage.



如图所示, 在机身预留的机翼插槽内涂抹泡沫胶, 两面均匀涂抹。
Apply the foam glue evenly on the reserved wing slots of the fuselage as shown in the picture.

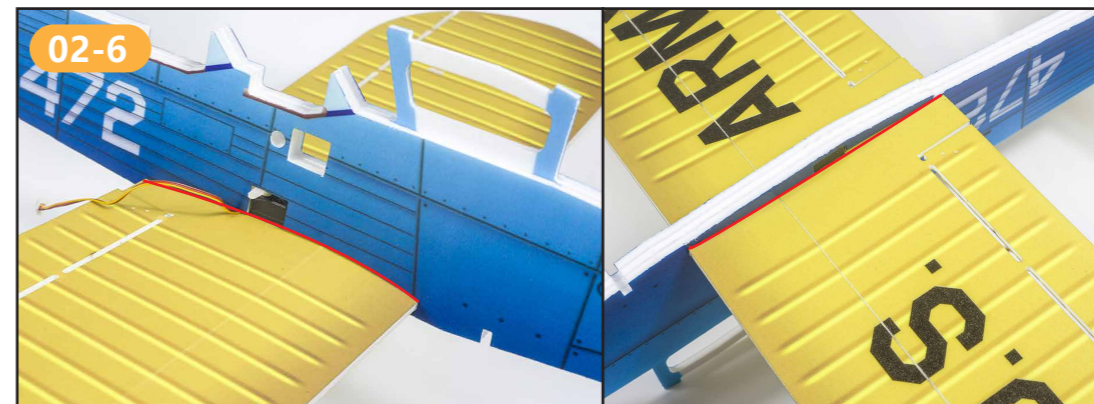

从02-4切开的口插入下机翼到机身, 注意机翼正反, 有字一面朝下, 调整机翼居后, 按压粘固并随预留槽使机翼呈一定弧度。
Insert the lower wing into the fuselage from the cut in 02-4. Pay attention to the front and back of the wing, with the words facing down. After adjusting the center of the wing, press and fix it and follow the reserved groove to make the wing curve.

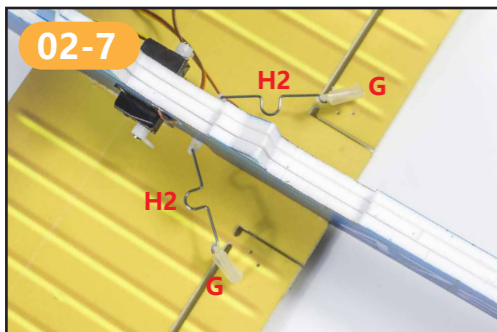

把钢丝连杆一端穿入舵臂,另一端穿入舵角,预装舵角在副翼上,并修剪舵角插针长度。
Insert one end of the steel wire linkage into the servo arm, and the other end into the servo horn, pre-install the servo horn on the aileron, and trim the pin length of the servo horn.

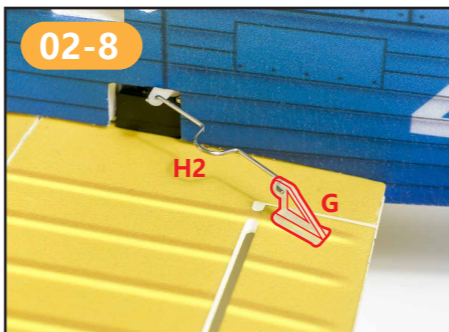

调整好舵角后,涂抹泡沫胶,把舵角粘固在副翼上。
After adjusting the servo horn, spread the foam glue to fix the servo horn on the aileron.



在尾翼预留槽嵌入小碳片,用泡沫胶粘固。
Insert a small carbon sheet into the reserved slot of the tail wing and fix it with foam glue.



把水平尾翼插入机身尾部,连接处用泡沫胶粘固。
Insert the horizontal tail into the tail of the fuselage, and fix the joint with foam glue.



如上图,在转向舵上贴一段透明胶,然后把转向舵粘到机身尾翼上。保留1mm间距。
As shown in the above picture, paste a piece of transparent glue on the steering rudder, and then paste the steering rudder to the tail of the fuselage. pls take care to keep 1mm spacing.



在转向舵下方与机身连接处,用少量泡沫胶粘固。
Use a small amount of foam glue at the connection point under the steering rudder and the fuselage.

连杆连接舵机与升降舵、转向舵

The connecting rod connects the servos to the elevator and rudder

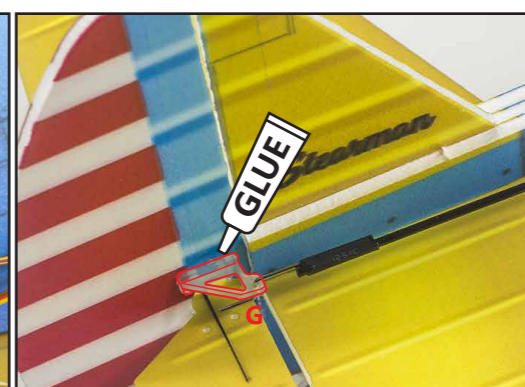
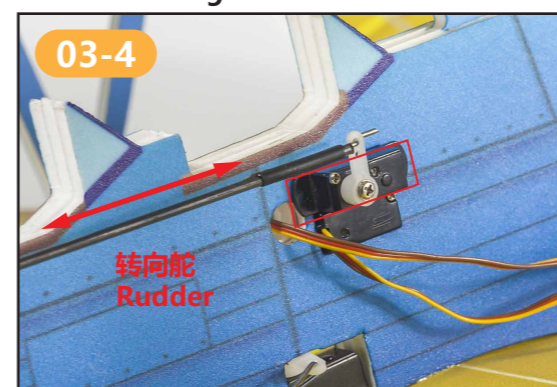

把制作好的一端Z型头穿入舵机的舵臂,然后参考尾翼上舵角的位置,确定连杆合适的长度,并切除多余的碳杆。
Insert the finished Z-shaped end into the rudder arm of the steering gear, and then refer to the position of the rudder horn on the tail to determine the appropriate length of the connecting rod, and cut off the excess carbon rod.

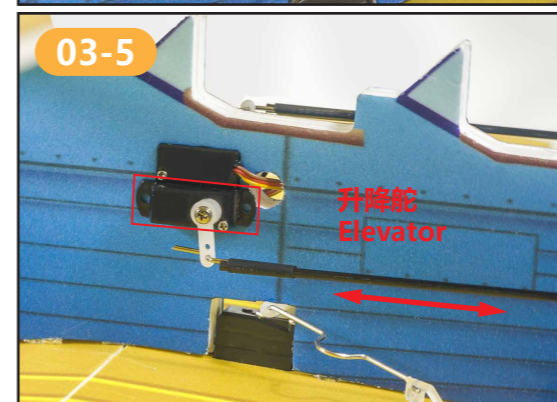

然后对照步骤制作连杆另一端的Z型头。
Then follow the steps to make the Z-shaped head at the other end of the connecting rod.

完成Z型头后,把Z型头穿入舵角,把舵角用泡沫胶粘在舵面上。
After finishing the Z-shaped head, insert the Z-shaped head into the rudder horn, and glue the rudder horn to the rudder surface with foam glue.

继续拼装上机翼及起落架

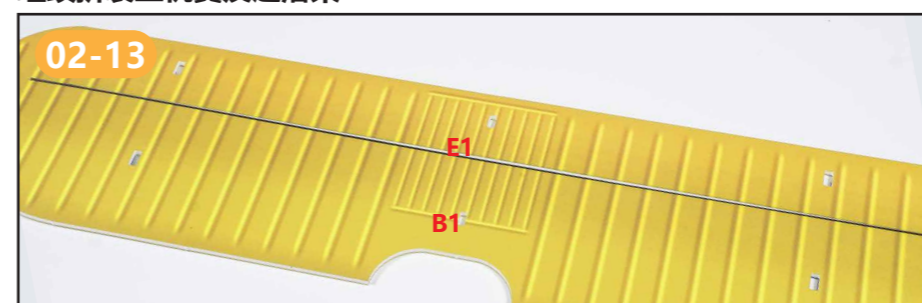

在上机翼B1底面预留槽内嵌入碳片,并用泡沫胶把碳片粘固在槽内。
Insert the carbon sheet into the reserved groove on the bottom of the upper wing B1, and fix the carbon sheet in the groove with foam glue.

舵机的安装 Install the Servo

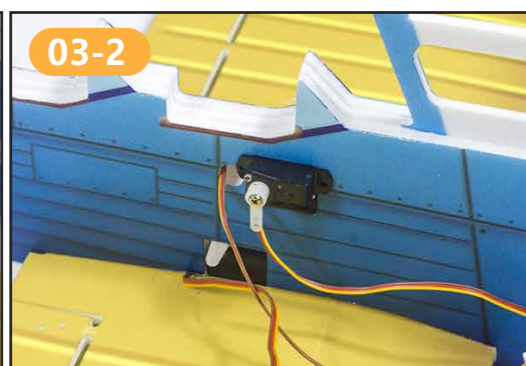
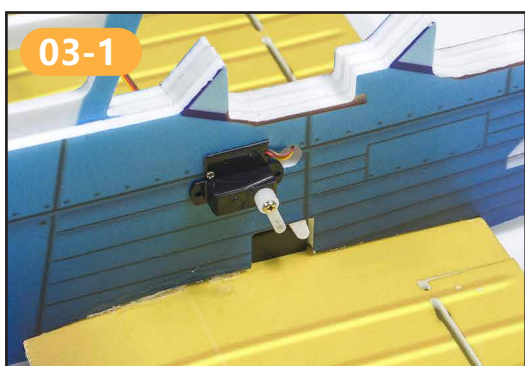

如左图,在机身中部安装舵机,上下交错安装。舵机线从预留孔整理到同一侧。
As shown in the picture on the left, the servo is installed in the middle of the fuselage, staggered up and down. Arrange the servo wires from the reserved holes to the same side.

连杆制作方法 Make the Connecting Rod



如左图,截取合适长度的热缩管,把Z型钢丝和碳杆套在一起,加热热缩管缩紧,然后点入少量CA胶加固。
As shown in the picture on the left, cut the suitable length of the heat shrinkable tube, sleeve the Z-shaped steel wire and the carbon rod together, heat the heat shrinkable tube to shrink it, and then add a small amount of CA glue to reinforce it.
注意: 2根连杆只做好一端的Z型头,另一端待后续步骤再制作。
Note: For the two connecting rods, only one end of the Z-shaped head should be made, and the other end will be made in subsequent steps.



在下机翼上粘贴机翼支架,用泡沫胶粘固,并使下机翼贴合支架的弧度。
Paste the wing bracket on the lower wing and fix it with foam glue, and make the lower wing fit the curvature of the bracket.

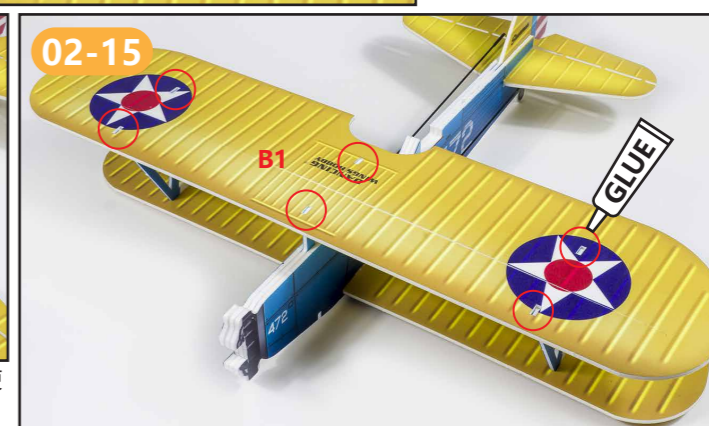

把上机翼粘到支架上,三处接触点粘固,并贴合支架的弧度。
Paste the wing onto the bracket and fix the three contact points to make it fit the arc of the bracket.

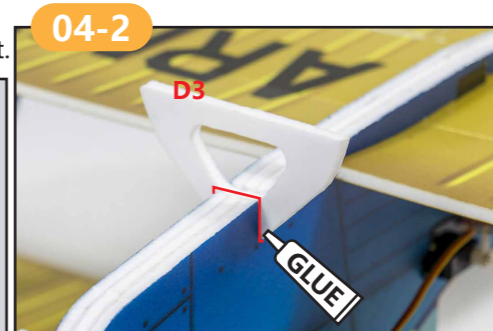

电子设备安装调试 Power System Installation and Adjustment



把马达安装在马达座上，用螺丝固定，并在马达上安装桨保护器，然后粘贴到机身头部，用泡沫胶粘固。

Install the motor on the motor mount and fix with screws, install the propeller saver on the motor, then paste it to the head of the fuselage and fix it with foam glue.

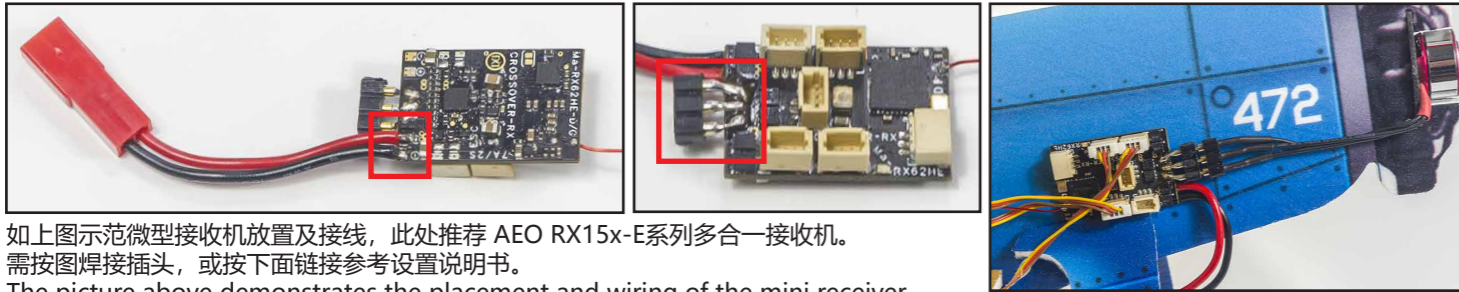

如上图示范微型接收机放置及接线，此处推荐 AEO RX15x-E系列多合一接收机。需按图焊接插头，或按下面链接参考设置说明书。

The picture above demonstrates the placement and wiring of the mini receiver. AEO RX15x-E series all-in-one receivers are recommended here.

Need to solder the plug according to the picture, or follow the link below to refer to the setup manual.

AEO RX15x-E 说明书链接:

Description link:

<https://www.aeorc.com/rx14amp14eamp15e-series-mini-receiver-user-manual-a0074.html>

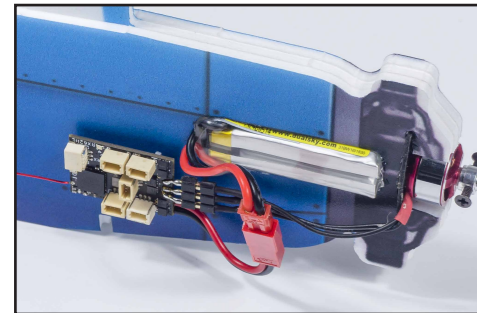

左图示范电池放置位置，用刀沿虚线切开槽位放置电池，如自备电池不适合孔位可不切开。

The left picture shows the battery placement position. Use a knife to cut the slot along the dotted line to place the battery. If your own battery does not fit the hole, you don't need to cut it.



更多电子设备调试细节可参考以下链接查看 (可直接扫二维码)
More details about power system adjustment, please refer to below link: (You can scan QR Code directly.)
<http://www.dwhobby.com/art/connection>

重心位置展示 Display for C.G

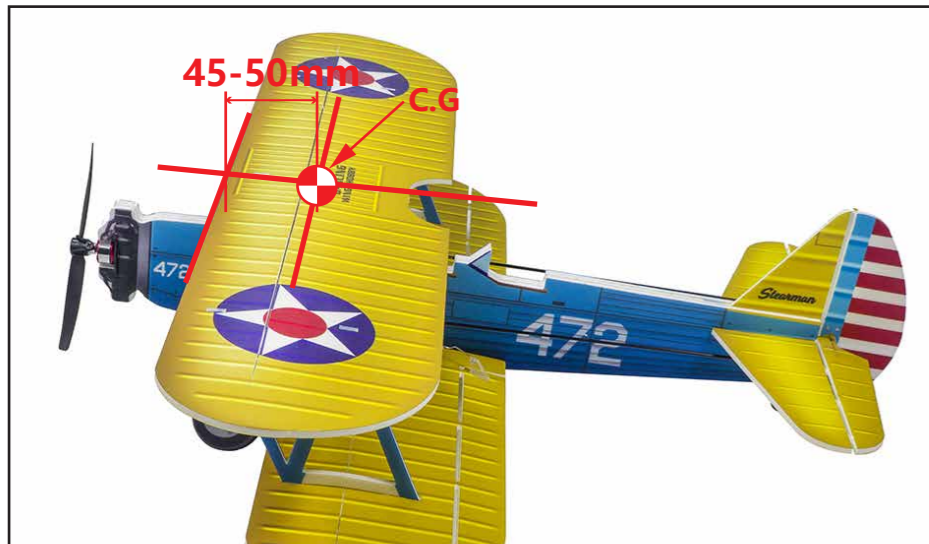

常规飞行(Normal Flying)

副翼 Aileron $\pm (15^\circ-30^\circ)$

平尾 Elevator $\pm 15^\circ$

垂尾 Rudder $\pm 15^\circ$

常用襟翼 Flap (起飞 take-off) $15^\circ-20^\circ$ (降落 Landing) $20^\circ-40^\circ$

3D飞行 部分飞机支持(3D Flying only support some models)

$\pm 40^\circ$ 或者更大(or larger)

$\pm 40^\circ$ 或者更大(or larger)

$\pm 40^\circ$ 或者更大(or larger)

部分特殊机型会有V型尾翼，襟翼，前缘机翼或舵面很小等，可以以常规飞行的角度作为参考，在您不确认且没有有经验人员指导的情况下，我们建议您先以小角度试飞以确认您的设置是否正确。

Some special models will have V-tails, flaps, leading edge wings, etc., which can be used as a reference for conventional flight angles. If you do not confirm and there is no experienced person to guide you, we recommend that you first test at a small angle to confirm that your settings are correct.

地面控制方向测试 Control Directions Tests

	遥控器动作 Transmitter Command	飞机反应 Aircraft Reaction
升降舵 Elevator	升降杆下拉 Lifting rod down	
	升降杆上推 Lifting rod up	
副翼 Aileron	转向杆向右 Steering rod to the right	
	转向杆向左 Steering rod to the left	
方向舵 Rudder	方向杆向右 Direction rod to the right	
	方向杆向左 Direction rod to the left	