

Fixing Quantities

Length of Nominal Dome Side (mm)	Number of fixings per side
600, 750	2
900, 1050, 1200	3
1350, 1500, 1650	4
1800	5
2400	7

(All fixings supplied in packs of 5.)

Mardome Contents

Please unpack and check that all correct parts are included and undamaged.

All Mardome Trade

All Mardome Ultra

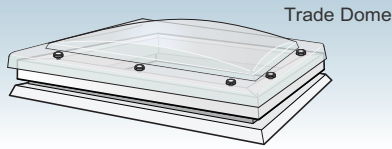

OR

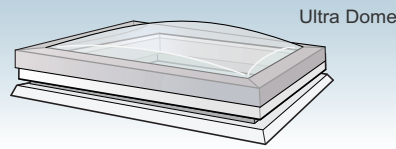

With either assembly, you will receive:
Kerb Fixings

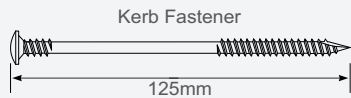

With either assembly, you will receive:
Mardome Opening Unit Extras

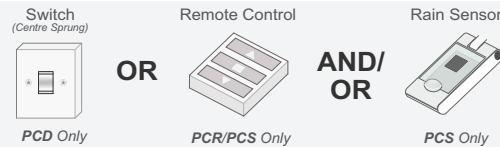

Mardome Installation

Please note that all Health and Safety Regulations must be followed on site throughout the installation process.

Powered PCD/R/S Opening dome on existing upstand

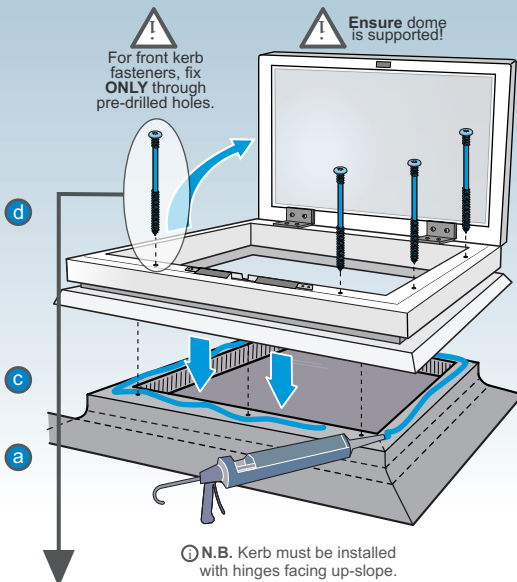

Dome connection to frame

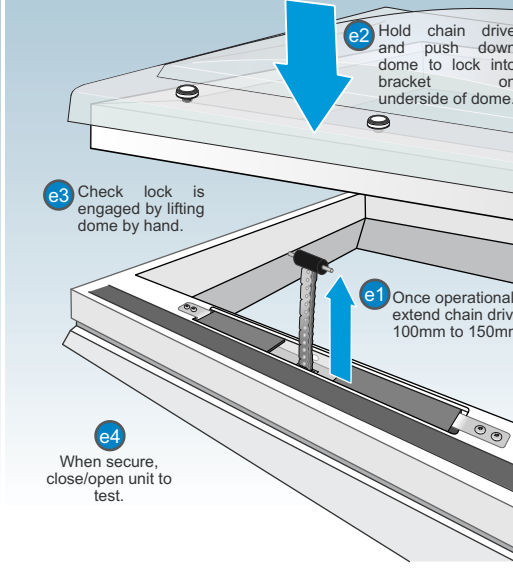

Installation Instructions

- ⚠ Ensure dome is supported in open position to avoid damage!
- a** Install roof covering to cover existing upstand in accordance with manufacturer's installation recommendations.
- b** Carefully remove roof light from its packaging and ensure that hinged dome is unlocked from frame and can be opened to 90°. If not disconnect, as shown.
- c** Mastic/Silicone around the edge of the upstand opening and correctly place kerb, ensuring it is located squarely to the upstand with hinges facing up-slope.
- d** Fix kerb to the builders upstand using the 125mm kerb fastener.
 - Ⓢ N.B. For front kerb fasteners, fix **ONLY** through pre-drilled holes to avoid electrical actuator/connections.
- #** Arrange for electrical connections to be made by a suitably qualified electrician to wire product as shown on reverse (See diagram # on Page 2).
- e** Ensure that the hinged dome is connected to the frame and locked into the closed position

Kerb Fixing

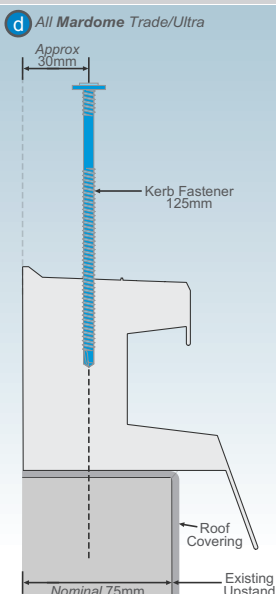

Mardome Opening Unit - IF Required

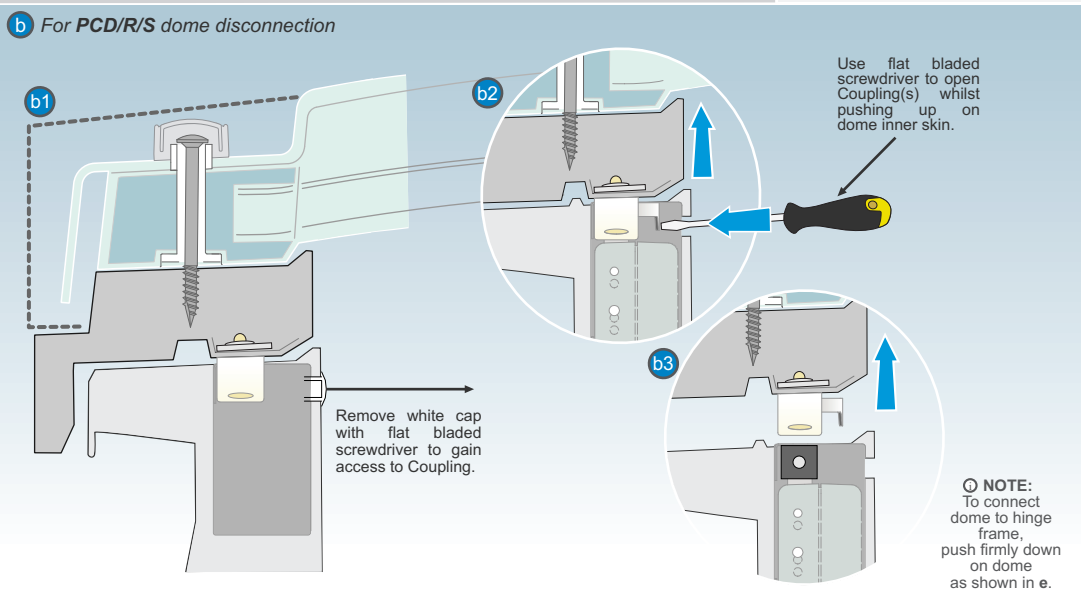

TECHNICAL SUPPORT: For any technical information/queries please contact your supplier.

For Mardome Trade/Ultra on to Existing Upstand See **Page 1** overleaf

Fixing Quantities

Length of Nominal Dome Side (mm)	Number of fixings per side
600, 750	2
900, 1050, 1200	3
1350, 1500, 1650	4
1800	5
2400	7

(All fixings supplied in packs of 5.)

Mardome Contents

Please unpack and check that all correct parts are included and undamaged.

All Mardome Trade

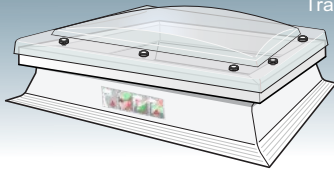

Trade Dome

All Mardome Ultra

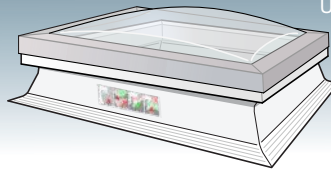

Ultra Dome

OR

With either assembly, you will receive:
Kerb Fixings

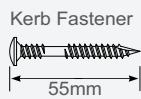

With either assembly, you will receive:
Mardome Opening Unit Extras



PCD Only

OR

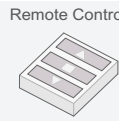

PCR/PCS Only

AND/OR

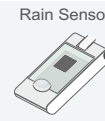

PCS Only

Mardome Installation

Please note that all Health and Safety Regulations must be followed on site throughout the installation process.

Powered PCD/R/S Opening dome on to sloping or 300mm kerb

N.B. Kerb must be installed with hinges facing up-slope.

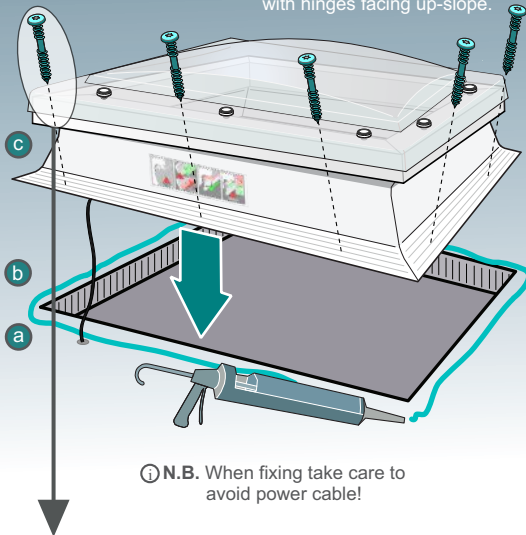

d Roof Covering Installation

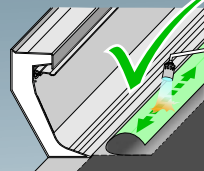

If required, lightly torch roof covering.



WARNING: Never apply direct heat or naked flame to the roof light!

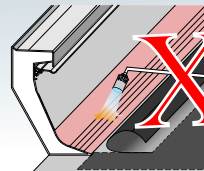

e IMPORTANT: Roof Covering Clamp Locking



Push along line as shown to lock. **DO NOT** push on soft area!

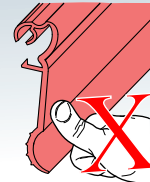

Installation Instructions

- Feed power cable through roof cavity as shown.
- Mastic/Silicone around the edge of the roof opening and correctly position kerb, ensuring it is located squarely over the roof opening with hinges facing up-slope.
- Fix kerb to the roof using the 55mm kerb fastener.

See above **Fixing Quantities** table for the correct quantity of fastenings required for the size of the dome.

N.B. Length of side refers to the nominal dome size (equivalent to inside base of kerb foot).
- Install roof covering up to lip, to stop under roof covering clamp, ensuring it **does not** foul clamp. Install in accordance with manufacturer's installation recommendations
- Lock the roof covering clamp down fully, as shown.
- Arrange for electrical connections to be made by a suitably qualified electrician to wire product as shown below.

Kerb Fixing

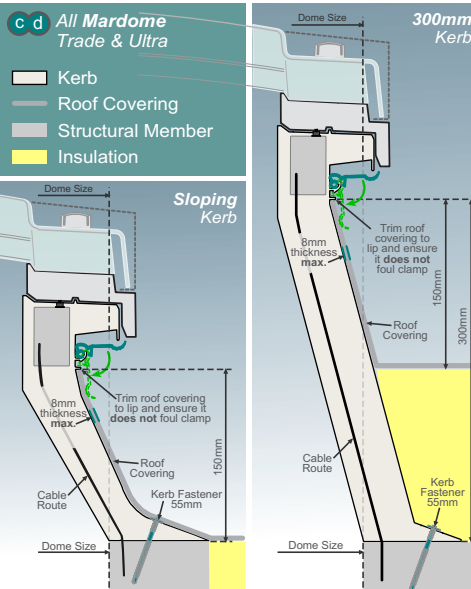

Mardome Opening Unit - Further Information

Please select the relevant detail below for your product:

Mardome Chain Drive Unit Wiring Diagram for M&E Installer

PCD Option

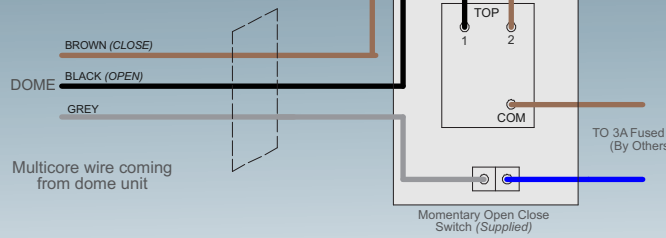

PCR Option

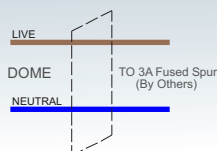

PCS Option

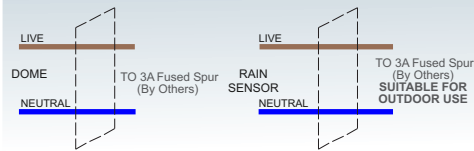

Please note that all wiring and commissioning must be undertaken by a suitably trained and qualified person. The installer must ensure that all wiring runs, cable thickness and earthing etc. meet current regulations.

230V (AC) actuators must not be operated by supplying continuous power. They must only be operated using a "Spring to Centre" type rocker switch (as supplied on PCD option) or by using a suitable controller with a timed pulse for the opening period required (approx 60 to 120 seconds for full operation). Feeding continuous power to a 230V actuator will damage the unit over time and void any warranty. Actuators have a 12 month limited warranty from delivery of the unit.

TECHNICAL SUPPORT: For any technical information/queries please contact your supplier.