

# OWNER'S MANUAL



**HALOTHERAPY CABINS &  
HALOTHERAPY + INFRARED SAUNA CABINS**



# Table of Contents

Installation - - - - -	04
<b>01   Halo STAR - - - - -</b>	<b>05</b>
<b>02   Halo IR - - - - -</b>	<b>21</b>
<b>03   Halo ADA - - - - -</b>	<b>37</b>
<b>04   Halotherapy Solutions Halogenerator - - - - -</b>	<b>55</b>
Using Your Halo IR Sauna Control Panel - - - - -	58
Important Safeguards- - - - -	61

\* The information contained in this manual is subject to change without notice.

# Installation

## Choosing a location

Installation requirements for your sauna are as follows:

1. Your Halotherapy Cabin is a self-contained and freestanding unit. It should not be built into any structure without prior authorization.
2. Please maintain a minimum of 4-inch clearance on all sides of the unit to allow air to circulate while giving access for the power cord.
3. Your Halotherapy Cabin should be placed on a level and dry area.

## Cleaning and maintenance

1. Before using your Halotherapy Cabin for the first time, clean the inside of the sauna with a damp cloth. Use your favorite furniture polish on the exterior.
2. Place a towel on the bench to absorb any perspiration. Wash these often to maintain a clean and pleasant environment inside your sauna.
3. Perspiration may darken the wood over time. This can be removed by a light sanding with fine grit sandpaper.



Please be careful when carrying and installing the glass pieces to avoid breakage.

**01**

# Halo STAR

Packaging	06
Assembly Instructions	07

# Packaging

## CONTENTS OF BOXES

### Box 1 of 5

- 1. Floor Panel
- 2. Ceiling Panel
- 3. Accessories
- 4. Installation Manual

### Box 2 of 45

- 1. Left Side Wall
- 2. Right Side Wall

### Box 3 of 5

- 1. Front Wall
- 2. Back Wall
- 3. Bench & Bench Support

### Box 4 of 5

- 1. Front Heaters

### Box 5 of 5

- 1. Halotherapy Generator

## ACCESSORY BOX CONTENTS



Door Handle



Roof Screws

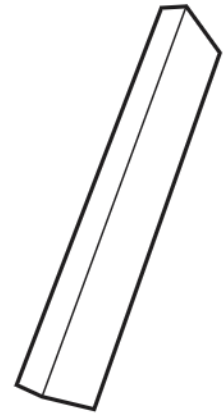

Wood piece  
(2 pieces)

# Assembly Instructions

Assembly of the Halotherapy Cabin requires two adults to complete. Please read the instructions thoroughly before and during assembly to ensure proper installation of the unit.

## 1 - LOCATION OF CABIN & INSTALLATION ORDER

When determining a location for your Halotherapy Cabin, please keep in mind the following:

1. The main power cord on the cabin must be easily accessible.
2. The location must be dry and level.
3. Panels should be installed in the following order:
  - 1) Floor
  - 2) Back Wall
  - 3) Left Side Wall
  - 4) Right Side Wall
  - 5) Under Bench Support
  - 6) Bench
  - 7) Front Wall
  - 8) Ceiling
  - 9) Install Halotherapy Unit

## 2 - PLACING FLOOR PANEL

1. Place the bottom floor panel on the ground near the location you will use the cabin. Make sure the front of the floor is in the desired location of the door.

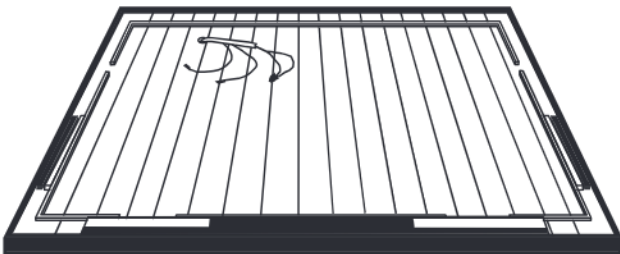

## 3 - CONNECTING THE BACK PANEL TO THE FLOOR PANEL

1. Place the back panel on the floor panel by placing it in the groove of the floor panel.

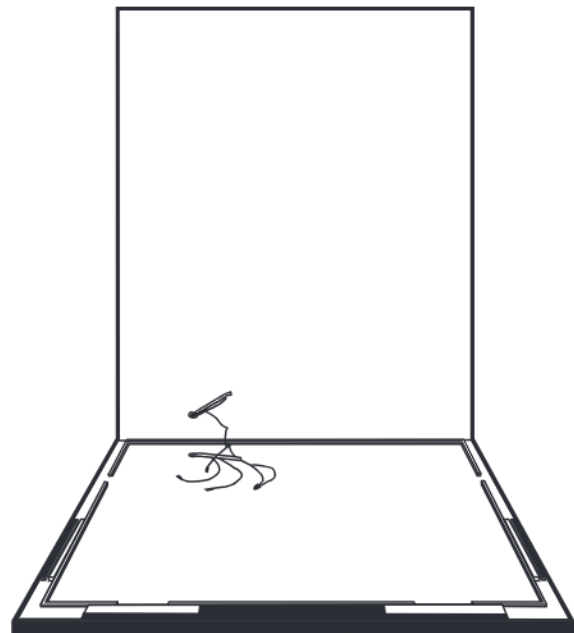

# Assembly Instructions Cont'd

## 4 - CONNECTING FIRST WALL PIECES

The side wall panels connect to the back wall with the installed locking brackets. There are mating brackets on the side of each panel.

1. Place the small left side wall with the Charging Station in the slot in the floor. Lift the side wall up about 4" (10cm) higher than the backwall panel (See Picture 1).
2. Place the side wall panel against the back wall (See Picture 2), then slide down side wall panel until the two panels are equal height. (See Picture 3).
3. If the panels are not equal height or there is an obvious gap between the two panels, this means they are not properly attached and you should try again.
4. Repeat the steps above with the small right side wall panel with the keypad.

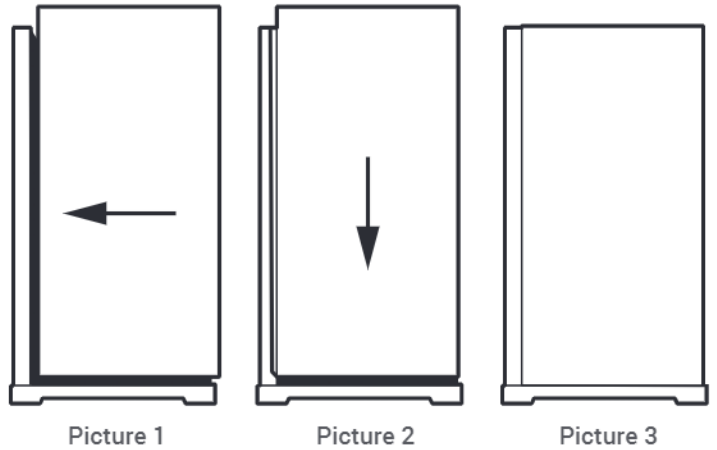

If the panels still seem too tight to come down all the way, try backing off the bracket screws by one half turn with a Phillips head screwdriver on the female bracket.

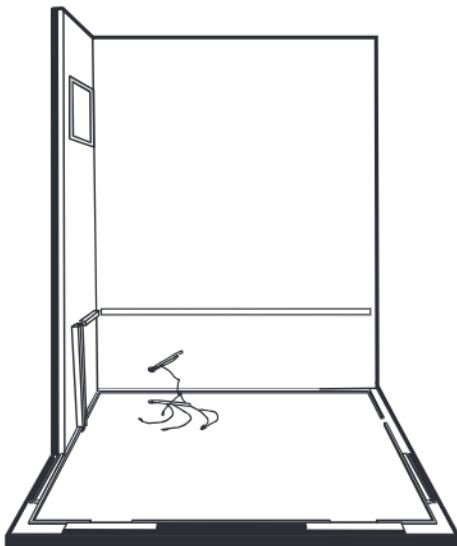

Left Side Wall Installed

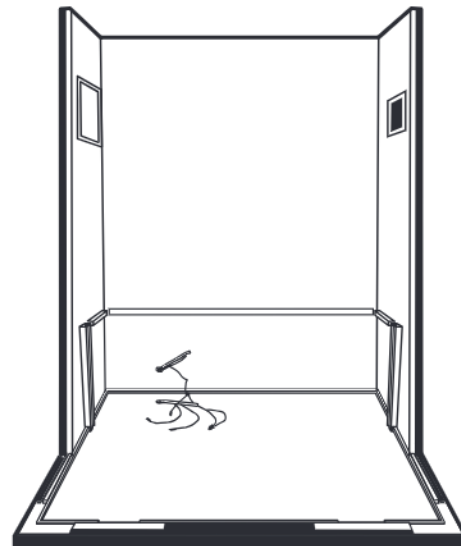

Right Side Wall Installed



# Assembly Instructions Cont'd

## 5 - INSTALLING UNDER BENCH SUPPORT

Slide down the under bench panel by lining up its sides with the angled vertical guides on the left and right side wall panel.

1. Be careful not to scratch the side panels when positioning the heater panel.
2. Push the under bench panel all the way down until it is touching the floor panel and securely in place.

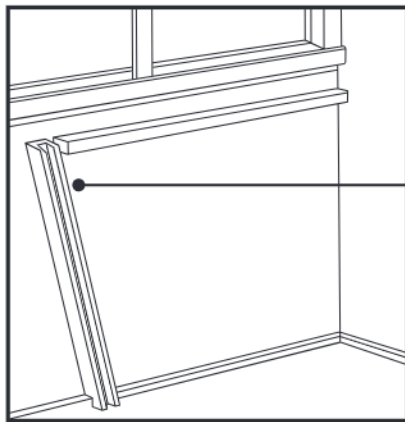

▶ Vertical bench heater panel guides are found on the side panels.

Heater must be facing outward

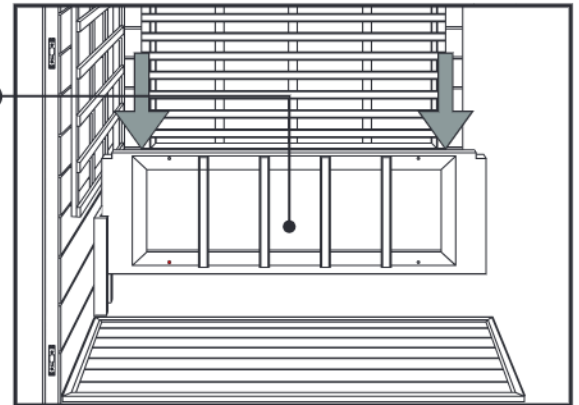

▶ Be careful not to damage the salt blocks pre-installed in the under bench support.

# Assembly Instructions Cont'd

## 6 - CONNECT LIGHT CONNECTION UNDER BENCH

Follow the connections as in the following illustration:

1. Connect the cable coming out of the back of the under bench support to one of the left side wall connectors.

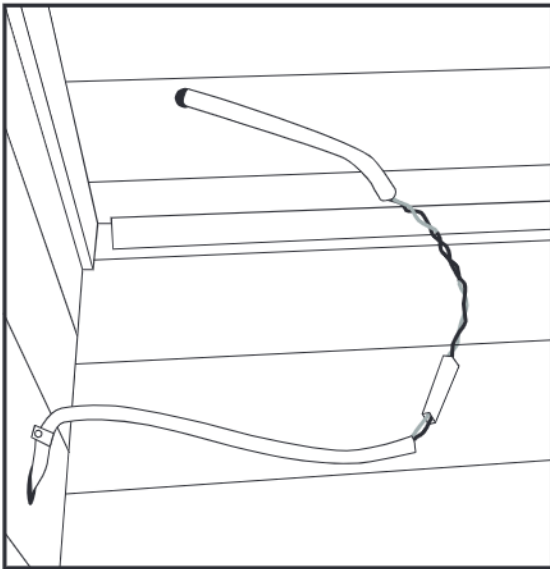

# Assembly Instructions Cont'd

## 7 - INSTALLING THE BENCH

Install the bench panel by sliding it over the horizontal bench guides on the side panels. Be careful not to scratch the adjacent panels when sliding in the bench.

Push the bench all the way in until it touches the back panel and is securely in place.

**Be sure that the bench is pushed all the way back until it slides under the guard to secure the bench in place.**

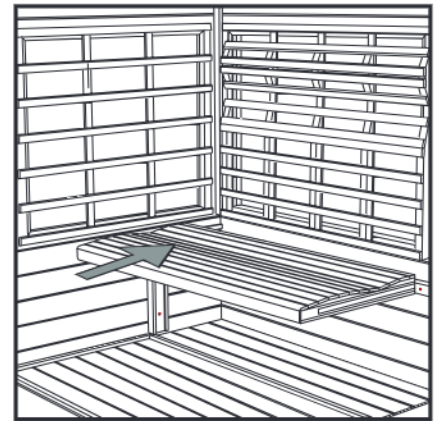
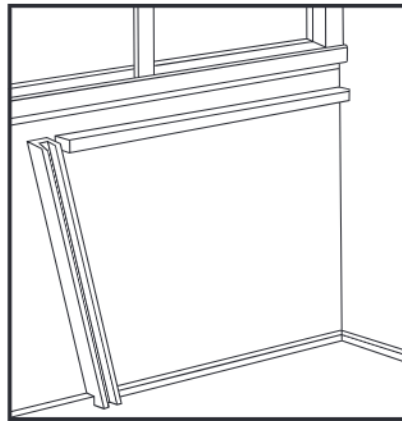

# Assembly Instructions Cont'd

## 8 - INSTALL SIDE WALL GLASS AND COLUMNS

1. Located the two side glass pieces.

Insert left glass piece and insert it into the slot at the opening of the left side wall.

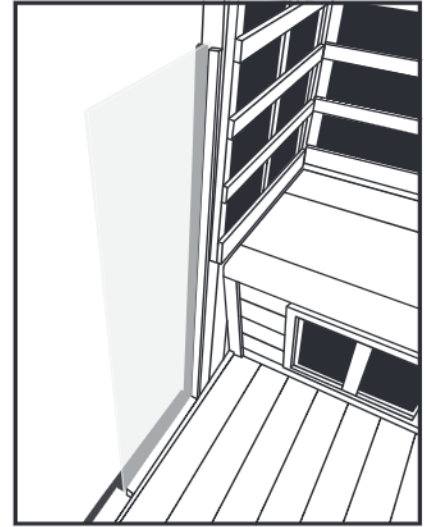

2. Locate the left front Column.



Place the column in the slot in the floor at the left front corner of the floor securing the glass in place.

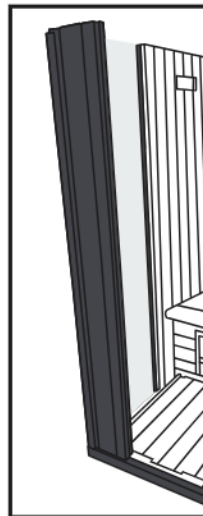

# Assembly Instructions Cont'd

## 8 - INSTALL SIDE WALL GLASS AND COLUMNS

Insert the Right Side Glass and insert it into the slot at the opening of the left side wall.

Locate the right column and place the column in the slot in the floor at the left front corner of the floor securing the glass in place.

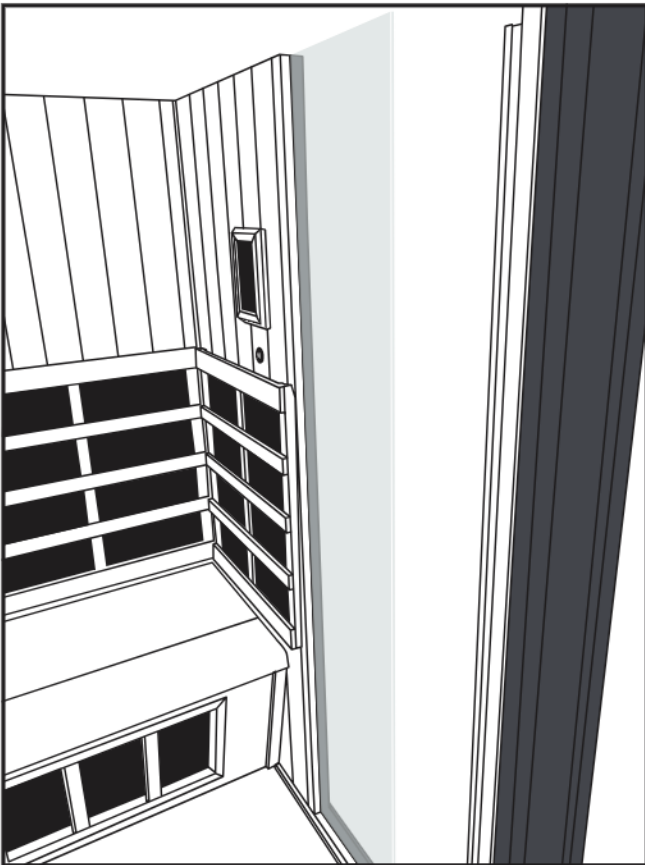

# Assembly Instructions Cont'd

## 9 - INSTALLING THE ROOF

Install the roof of the cabin by placing the roof on top of the walls and columns.



# Assembly Instructions Cont'd

## 10 - INSTALLING FRONT GLASS

1. Located the right front glass piece and door section. The right front glass comes already attached to the door.
2. Being careful not to knock over the right side column, slightly tip up the front corner of the roof about 6 inches.

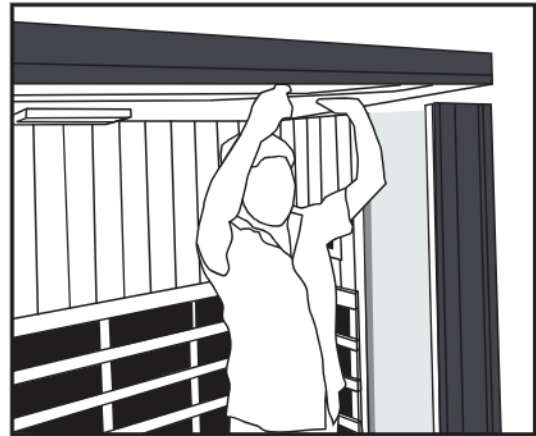

3. Being careful not to stress the hinges, slide the Right Front Glass piece into the slot in the Right Column and then insert it into the slot in the floor.
4. Place the roof back in place over the right and left columns making sure it is securely in place.
5. Locate the Left Side Front glass.



# Assembly Instructions Cont'd

## 10 - INSTALLING FRONT GLASS

6. Being careful not to knock over the left side column, slightly tip up the front corner of the roof about 6 inches.
7. Slide the Left Front Glass piece into the slot in the Light Column and then insert it into the slot in the floor.
8. Place the roof back in place over the right and left columns making sure it is securely in place.

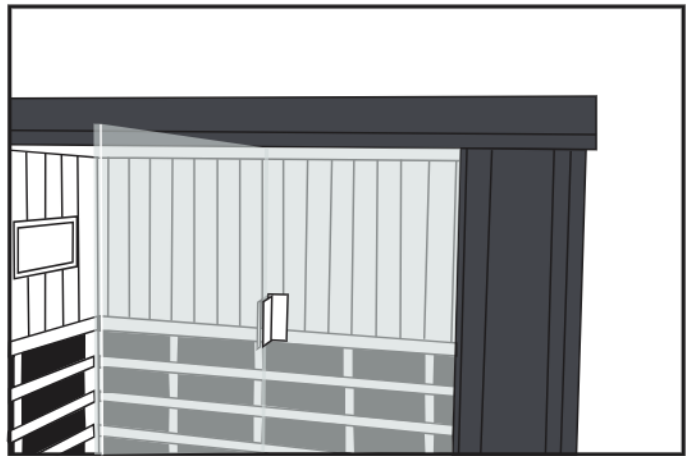

9. Find the plastic door weather stripping. Attach the weather stripping to the left side door glass by sliding it on to the glass.





# Assembly Instructions Cont'd

## 11 - SECURE THE ROOF

1. Locate the four long Roof Screws.

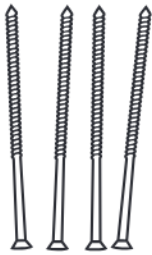

2. These screws will be used to secure the roof in place. In the front corners of the top side of the roof you will see a pre-drilled hole in each corner. Screw one screw in each corner.

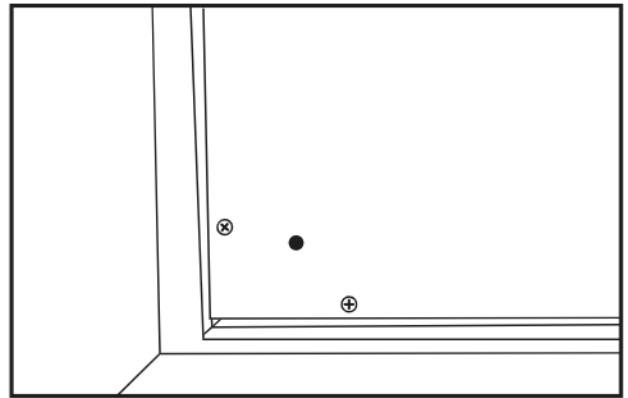

3. Locate and open the trap doors in the roof at the back corners. You will see a pre-drilled hole in each corner. Screw one screw in each corner.

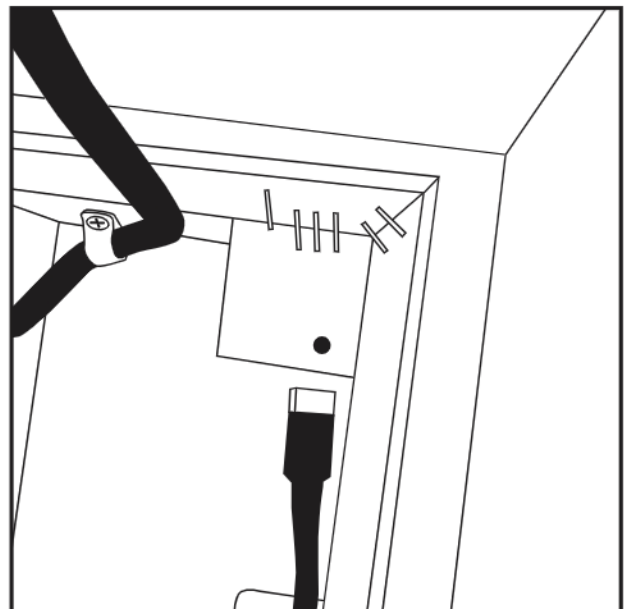

# Assembly Instructions Cont'd

## 12 - INSTALLING THE DOOR HANDLE

1. Locate the door handle.
2. Attach the door handle using the enclosed bolts.
3. Insert the included decorative mushroom caps in the screw hole to cover the screws



## 13 - CONNECT HEATERS IN ROOF

1. Locate the "trap" doors that open in the wood roof.
2. Connect the cables that come out of the side wall to the connector located in the wood roof.

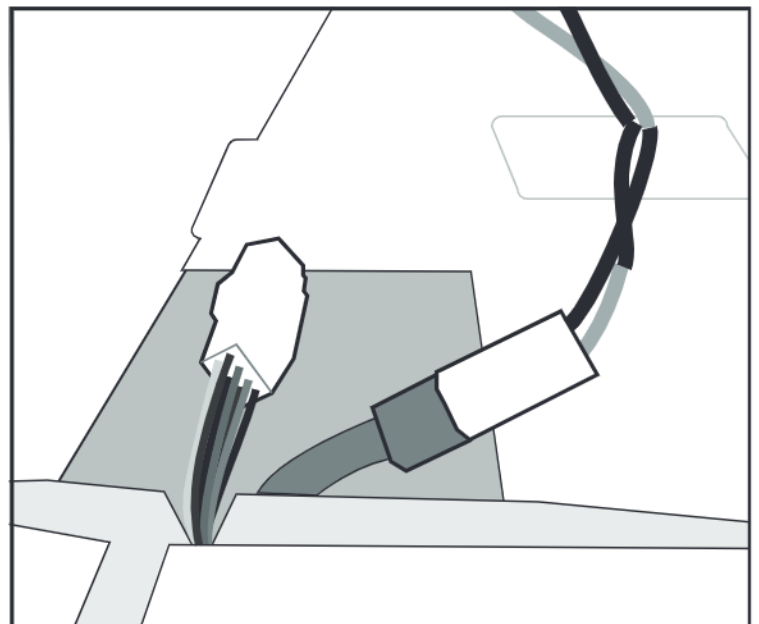

# Assembly Instructions Cont'd

## 14 - LOCATING AND PLUGGING IN POWER CORD

The power cord comes out of the roof of the Halotherapy Cabin. It is located in the trap door in the roof at the rear left facing corner. The power cord will plug into the appropriate electrical outlet. The power cord is 8' long.



**Note:** We do not recommend using an extension cord for your Halotherapy Cabin. Please plug the Halotherapy Cabin directly into the wall receptacle.

## 15 - INSTALLING THE HALOTHERAPY SOLUTIONS HALOGENERATOR

See page 44, "Installing the Halotherapy Solutions Halogenerator" to install the Halogenerator in the cabin.

## 16 - USING YOUR HALOTHERAPY CABIN

1. Press the "INSIDE" button to turn on and off the inside reading lights.
2. Press the "SALT" button to turn on the Halotherapy unit. TURBO mode will be activated automatically and will provide a burst of salt for 2 seconds every 2 minutes.
3. You can increase the amount of salt being dispersed by adjusting the "TURBO" burst and time in between bursts by doing the following (Please note this only has to be done if you want more salt which is not necessary for efficacy, but may help with the user perception. It is strongly recommended to not go above 4 seconds for the turbo):
  - Hold the TURBO Button down for 5 seconds.
  - The burst duration of 2 seconds will be displayed on the left side of the keypad display. Using the UP/Down arrows you can adjust the burst time from 1 - 6 seconds.
  - Press "TURBO" again to adjust the time between bursts. The default of 2 minutes will be displayed on the right side of the keypad display. Using the UP/DOWN arrows you can adjust the time between bursts from 1-5 minutes.
  - After setting the "TURBO" function, wait 5 seconds to exit programming mode.



# Assembly Instructions Cont'd

## 17 - AUDIO SYSTEM

Your Halo STAR Cabin is equipped with stereo speakers that can be accessed by Bluetooth.

1. Your Halo Star Cabin is Bluetooth ready. To connect audio via Bluetooth:
  - A) Open your Bluetooth enabled phone, tablet or computer and search for surrounding Bluetooth devices to find a device called **Infrared Sauna**. The pairing code for this device is **0000**.
2. There is a 3.5mm jack in the charging compartment that is connected to the speakers in your cabin. You can connect any audio to the speakers using this connection.

## 18 - INSTALLATION IS COMPLETE

Installation of your Halotherapy Cabin is now complete. Using a damp cloth, wipe out the cabin to remove any excess saw dust that may have settled on the wall & floor panels and the heater panels during manufacturing and shipment.

Please refer to usage instructions located later on in this manual.



# 02

# Halo IR 1,2 and 3

Packaging	22
Assembly Instructions	23

# Packaging

## CONTENTS OF BOXES

### Box 1 of 5

1. Floor Panel
2. Ceiling Panel
3. Accessories
4. Installation Manual

### Box 2 of 45

1. Left Side Wall
2. Right Side Wall

### Box 3 of 5

1. Front Wall
2. Back Wall
3. Bench & Bench Support

### Box 4 of 5

1. Front Heaters

### Box 5 of 5

1. Halotherapy Generator

## ACCESSORY BOX CONTENTS



Door Handle

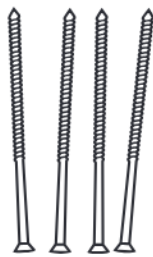

Roof Screws



Wood piece  
(2 pieces)

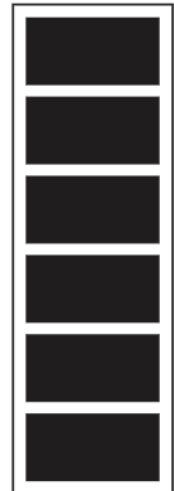

4 Heaters

# Assembly Instructions

Assembly of the Halotherapy Sauna requires two adults to complete. Please read the instructions thoroughly before and during assembly to ensure proper installation of the unit.

## 1 - LOCATION OF SAUNA & INSTALLATION ORDER

When determining a location for your Halotherapy Sauna, please keep in mind the following:

1. The main power cord on the sauna must be easily accessible.
2. The location must be dry and level.
3. Panels should be installed in the following order:
 

1) Floor	4) Right Side Wall	7) Front Wall
2) Back Wall	5) Under Bench Support	8) Ceiling
3) Left Side Wall	6) Bench	9) Halotherapy Unit

## 2 - PLACING FLOOR PANEL

1. Place the bottom floor panel on the ground near the location you will using the sauna. Make sure the front of the floor is in the desired location of the door. The two black connectors indicate the front of the sauna.

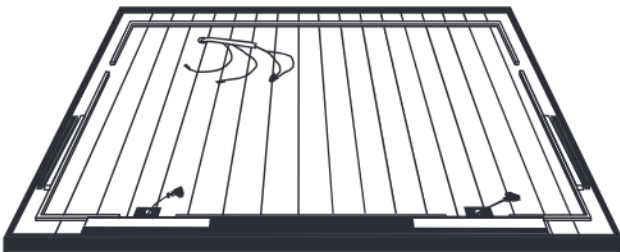

## 3 - CONNECTING THE BACK PANEL TO THE FLOOR PANEL

1. Place the back panel on the floor panel by placing it in the groove of the floor panel.

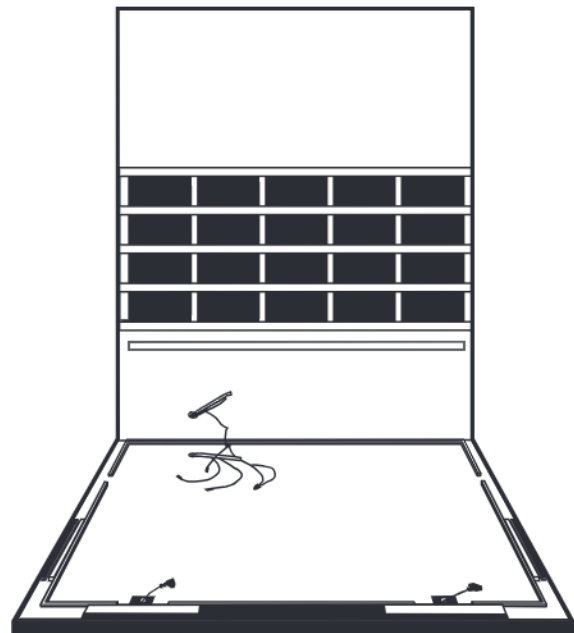

# Assembly Instructions Cont'd

## 4 - CONNECTING FIRST WALL PIECES

The side wall panels connect to the back wall with the installed locking brackets. There are mating brackets on the side of each panel.

1. Place the small left side wall with the Charging Station in the slot in the floor. Lift the side wall up about 4" (10cm) higher than the backwall panel (See Picture 1).
2. Place the side wall panel against the back wall (See Picture 2), then slide down side wall panel until the two panels are equal height. (See Picture 3).
3. If the panels are not equal height or there is an obvious gap between the two panels, this means they are not properly attached and you should try again.
4. Repeat the steps above with the small right side wall panel with the keypad.

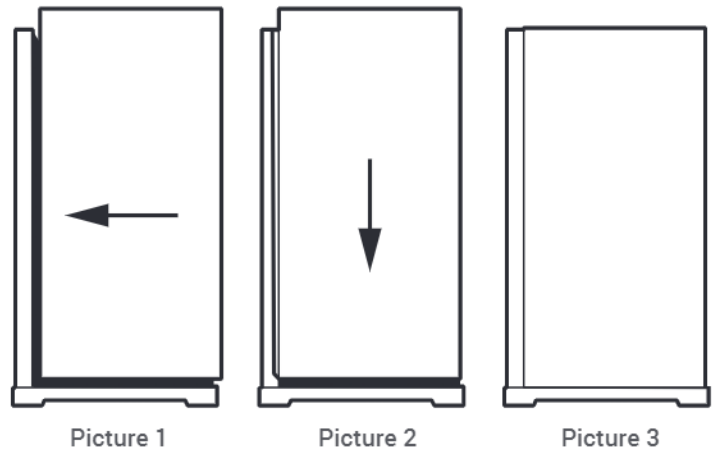

If the panels still seem too tight to come down all the way, try backing off the bracket screws by one half turn with a Phillips head screwdriver on the female bracket.

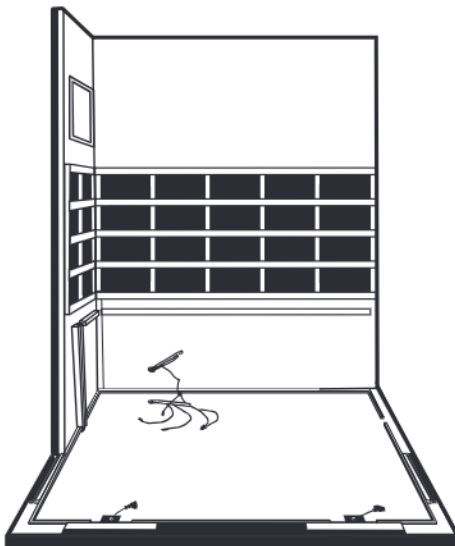

Left Side Wall Installed

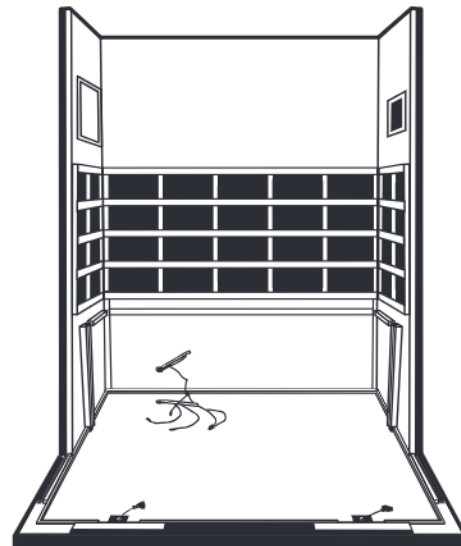

Right Side Wall Installed



# Assembly Instructions Cont'd

## 5 - INSTALLING UNDER BENCH SUPPORT

Slide down the bench heater panel by lining up its sides with the angled vertical guides on the left and right side wall panel.

1. Be careful not to scratch the side panels when positioning the heater panel.
2. Push the bench heater panel all the way down until it is touching the floor panel and securely in place.

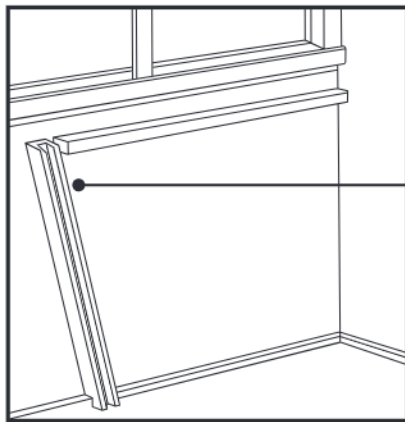

▶ Vertical bench heater panel guides are found on the side panels.

Heater must be facing outward

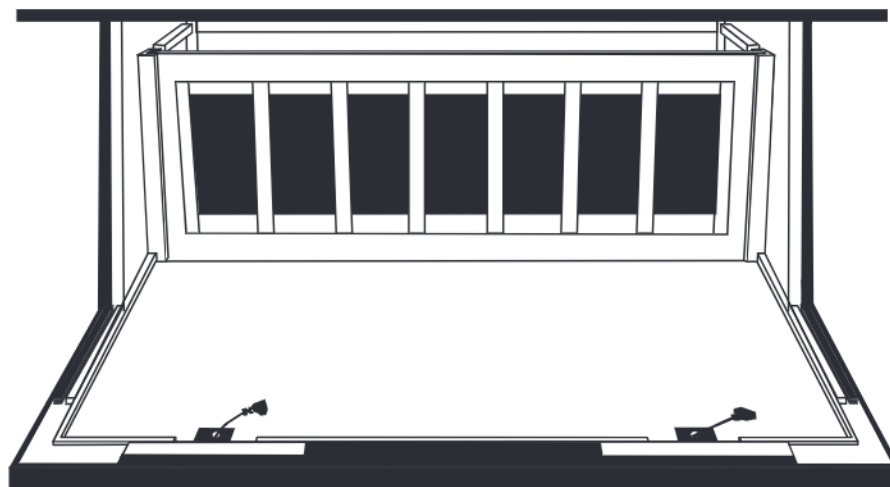
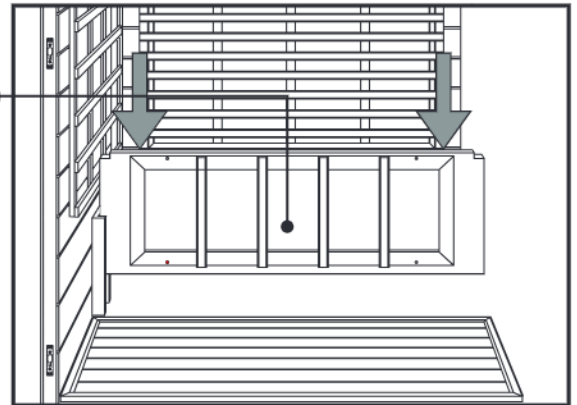

# Assembly Instructions Cont'd

## 6 - CONNECT HEATER CONNECTION UNDER BENCH

Follow the connections as in the following illustration:

1. Connect the black and white cable coming out of the back of the under bench support to one of the left side wall connectors.
2. Connect the side black and white wall cable to one of the floor connectors.
3. Connect the black and white back wall cable to the other floor connector.



You can plug any male connector to any female one as long as the colors match.

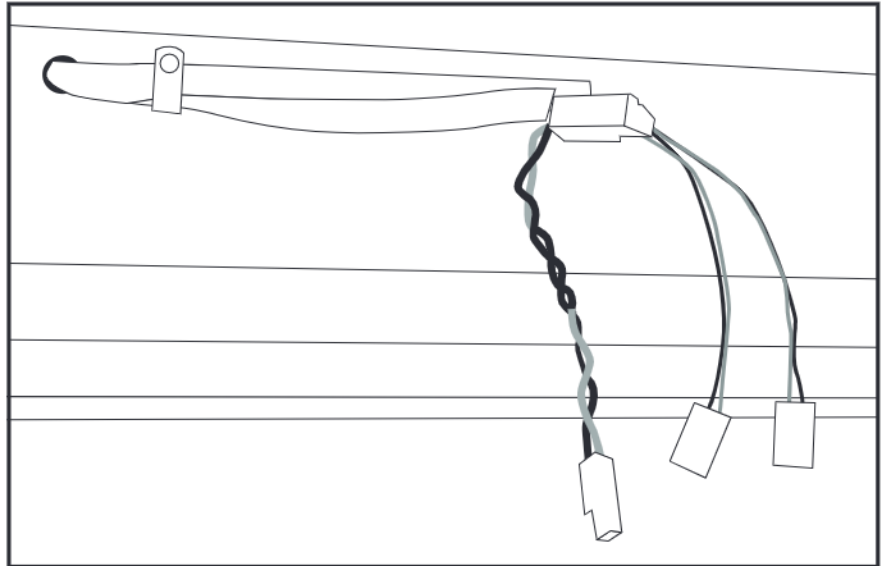
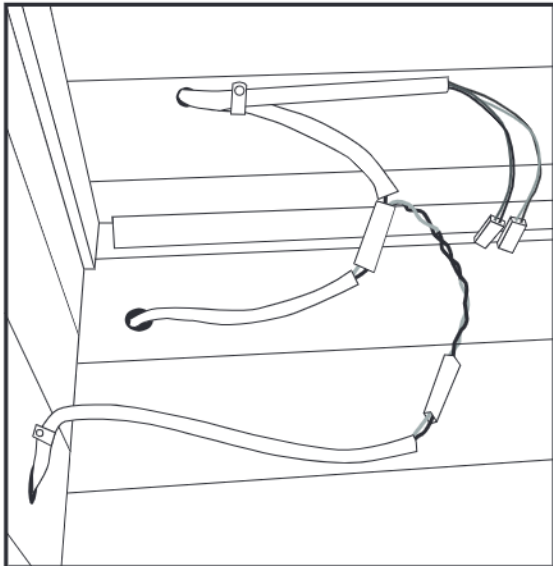

# Assembly Instructions Cont'd

## 7 - INSTALLING THE BENCH

Install the bench panel by sliding it over the horizontal bench guides on the side panels. Be careful not to scratch the adjacent panels when sliding in the bench.

Push the bench all the way in until it touches the back panel and is securely in place.

**Be sure that the bench is pushed all the way back until it slides under the heater guard to secure the bench in place.**

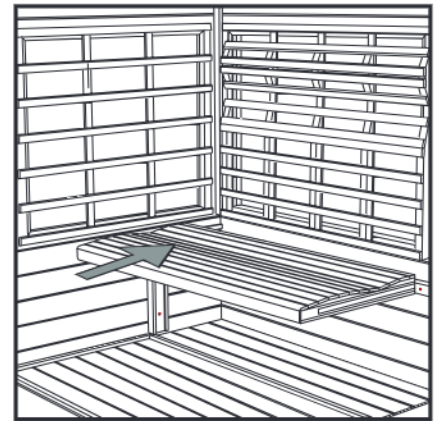
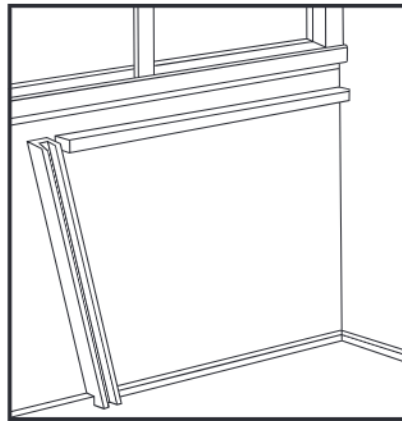
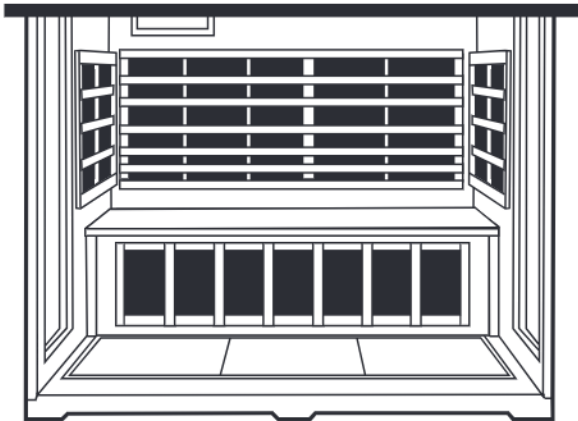

# Assembly Instructions Cont'd

## 8 - INSTALL SIDE WALL GLASS AND COLUMNS

1. Located the two side glass pieces.

Insert left glass piece and insert it into the slot at the opening of the left side wall.

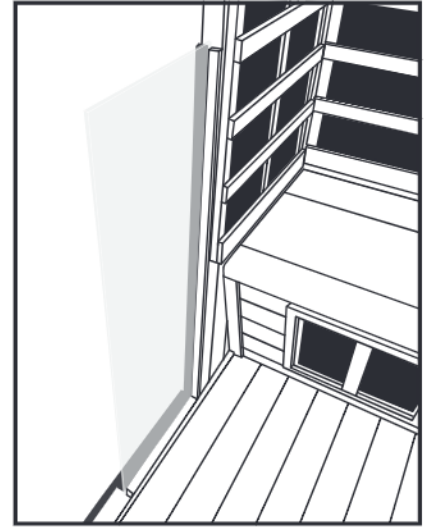

2. Locate the left front Column.



Place the column in the slot in the floor at the left front corner of the floor securing the glass in place.

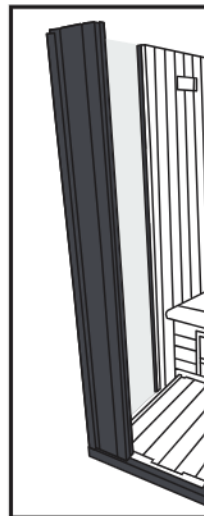

# Assembly Instructions Cont'd

## 8 - INSTALL SIDE WALL GLASS AND COLUMNS

Insert the Right Side Glass and insert it into the slot at the opening of the left side wall.

Locate the right column and place the column in the slot in the floor at the left front corner of the floor securing the glass in place.

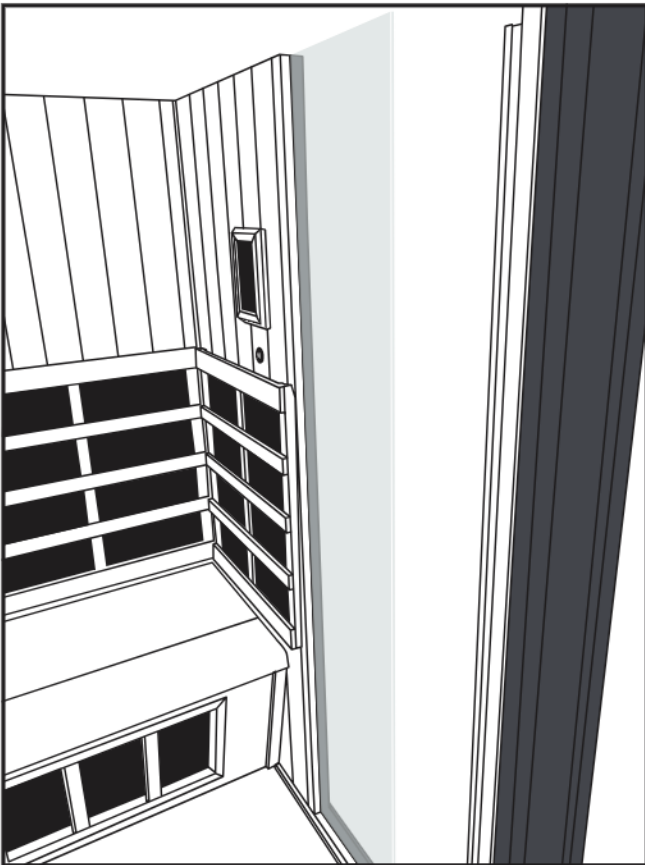

# Assembly Instructions Cont'd

## 9 - INSTALLING THE ROOF

Install the roof of the sauna by placing the roof on top of the walls and columns.



# Assembly Instructions Cont'd

## 10 - INSTALLING FRONT GLASS

1. Located the right front glass piece and door section. The right front glass comes already attached to the door.
2. Being careful not to knock over the right side column, slightly tip up the front corner of the roof about 6 inches.

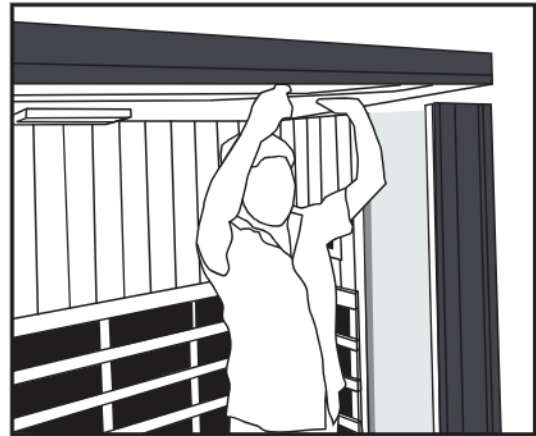

3. Being careful not to stress the hinges, slide the Right Front Glass piece into the slot in the Right Column and then insert it into the slot in the floor.
4. Place the roof back in place over the right and left columns making sure it is securely in place.
5. Locate the Left Side Front glass.



# Assembly Instructions Cont'd

## 10 - INSTALLING FRONT GLASS

6. Being careful not to knock over the left side column, slightly tip up the front corner of the roof about 6 inches.
7. Slide the Left Front Glass piece into the slot in the Light Column and then insert it into the slot in the floor.
8. Place the roof back in place over the right and left columns making sure it is securely in place.

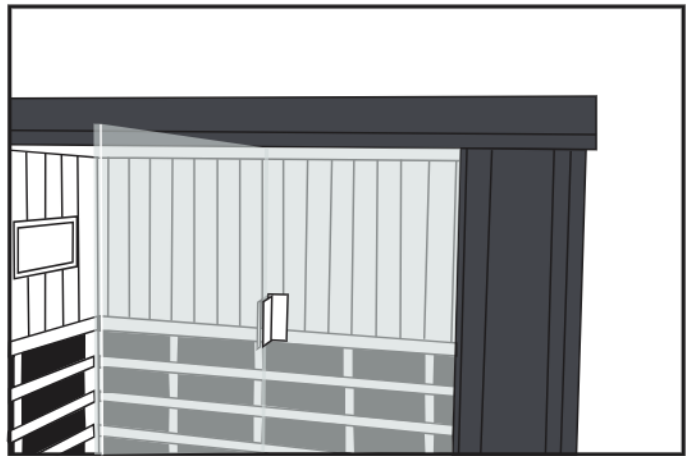

9. Find the plastic door weather stripping. Attach the weather stripping to the left side door glass by sliding it on to the glass.





# Assembly Instructions Cont'd

## 11 - SECURE THE ROOF

1. Locate the four long Roof Screws.

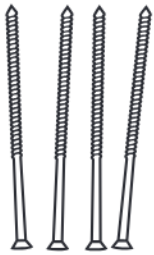

2. These screws will be used to secure the roof in place. In the front corners of the top side of the roof you will see a pre-drilled hole in each corner. Screw one screw in each corner.

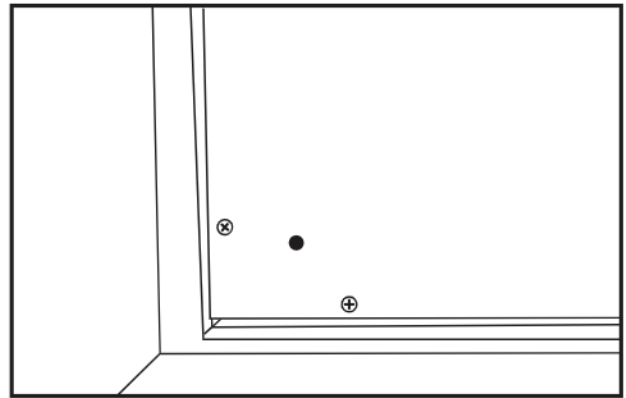

3. Locate and open the trap doors in the roof at the back corners. You will see a pre-drilled hole in each corner. Screw one screw in each corner.

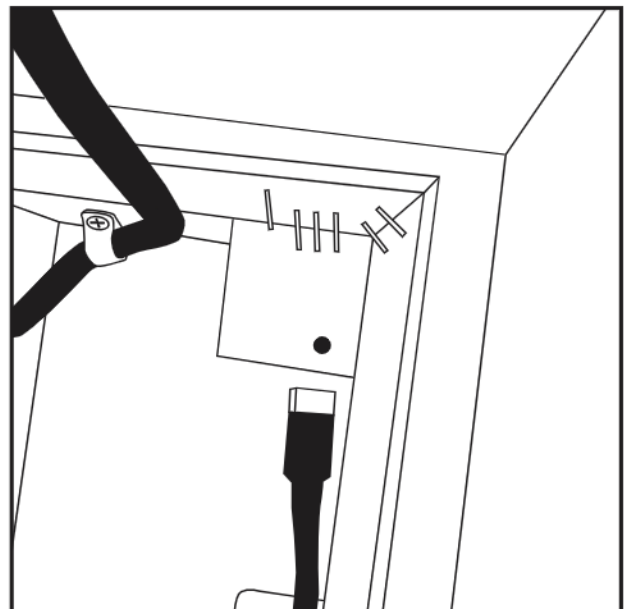

# Assembly Instructions Cont'd

## 12 - INSTALLING THE DOOR HANDLE

1. Locate the door handle.
2. Attach the door handle using the enclosed bolts.
3. Insert the included decorative mushroom caps in the screw hole to cover the screws



## 13 - CONNECT HEATERS IN ROOF

1. Locate the "trap" doors that open in the wood roof.
2. Connect the black and white cables that that come out of the side wall to the connector located in the wood roof.
3. In the left side wall compartment, there will be two connectors: 1) Heater connector. 2) Keypad connector. The heater connector is a two wire connector. The keypad connector is a seven wire connector.

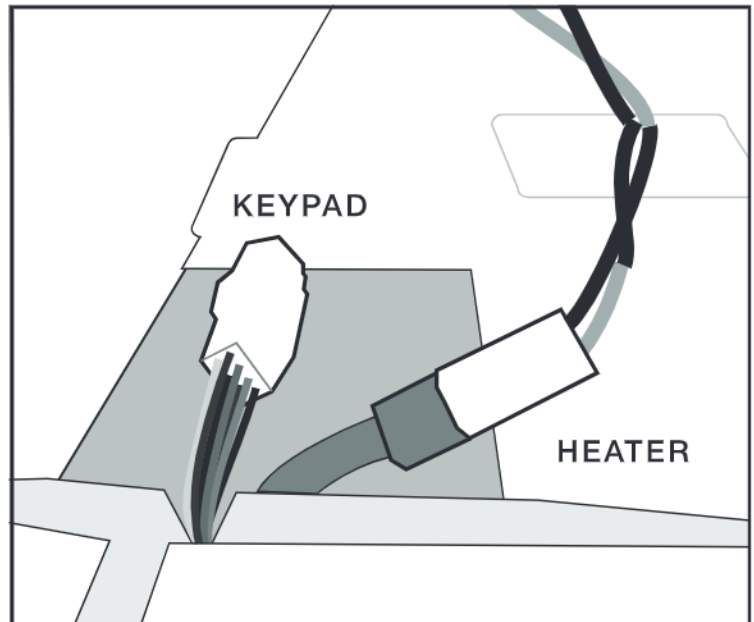

# Assembly Instructions Cont'd

## 14 - INSTALLING FRONT HEATERS

1. Locate the two front heaters and two side wall heaters. These heaters will attach to the glass.
2. Find the molex plug coming out of the bottom of one of the heaters. Align the heater with the holes in the glass and plug the heater into the molex connector coming out of the floor.
3. Align the the hole in the back of the heater with the hole in the front wall glass. Using the included screws and washers, secure the heater to the glass through the pre-drilled hole. One washer will be placed on the inside and one on the outside glass. The heater will be secured with these screws in two locations.

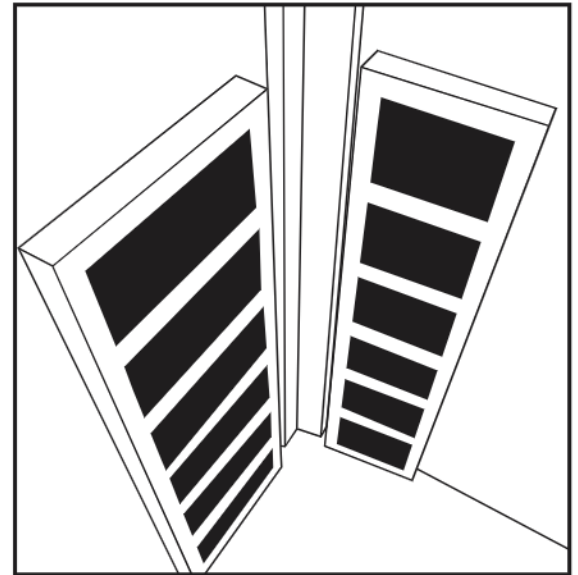

4. Repeat this for the right front wall heater and both side wall front heaters.

## 15 - LOCATING AND PLUGGING IN POWER CORD

The power cord comes out of the roof of the Halotherapy Cabin. It is located in the trap door in the roof at the rear left facing corner. The power cord will plug into the appropriate electrical outlet. The power cord is 8' long.



**Note:** We do not recommend using an extension cord for your sauna. Please plug the sauna directly into the wall receptacle.

# Assembly Instructions Cont'd

## 16 - INSTALLATION IS COMPLETE

Installation of your sauna is now complete. Using a damp cloth, wipe out the sauna to remove any excess saw dust that may have settled on the wall & floor panels and the heater panels during manufacturing and shipment.

Please refer to usage instructions located later on in this manual.

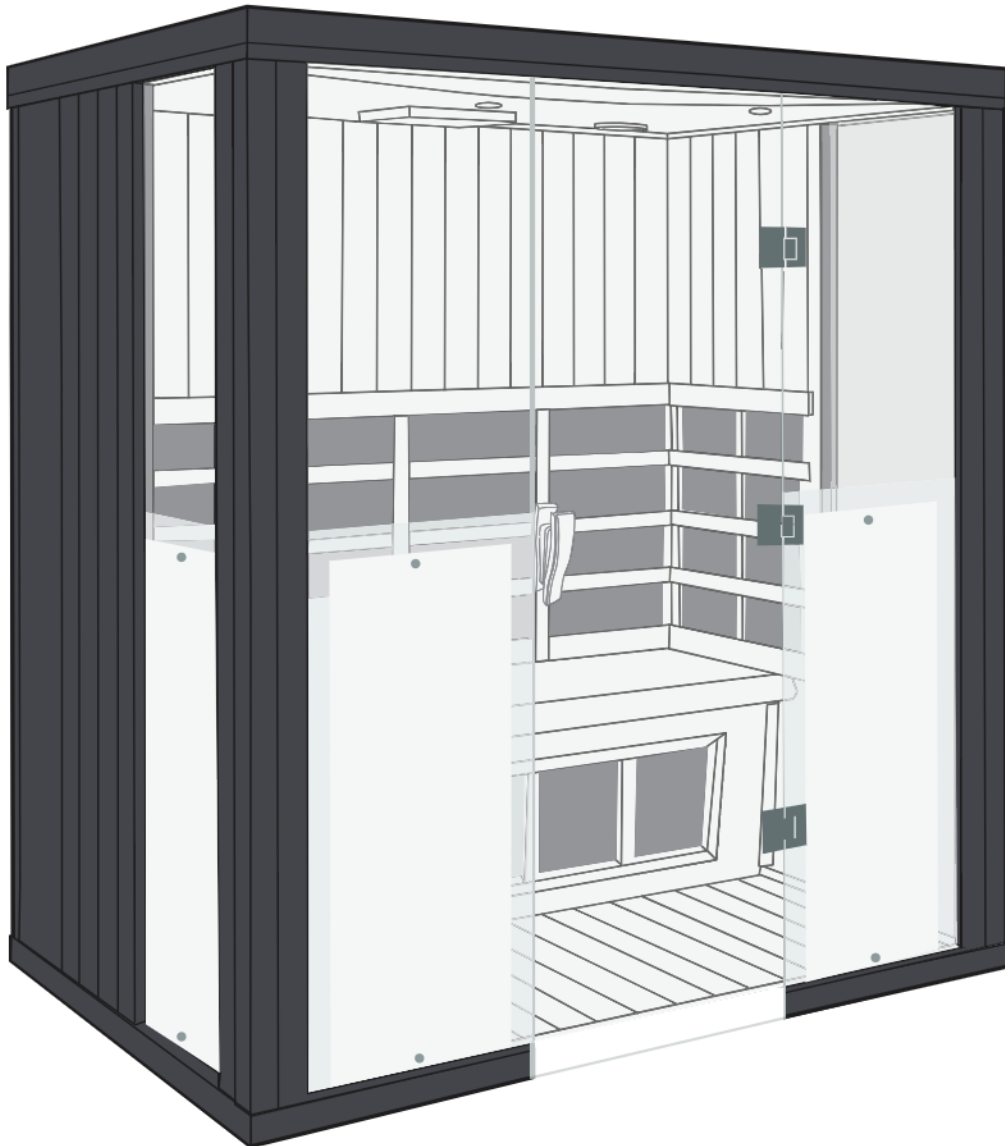

# 03

# Halo IR ADA

Packaging	38
Assembly Instructions	39

# Packaging

## CONTENTS OF BOXES

### Box 1 of 4

1. Floor Panel
2. Ceiling Panel
3. Accessories
4. Installation Manual

### Box 2 of 4

1. Left Side Wall
2. Right Side Wall

### Box 3 of 4

1. Front Wall Glass
2. Back Wall
3. Bench & Bench Support

### Box 4 of 4

1. Front Heaters

## ACCESSORY BOX CONTENTS

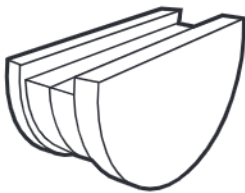

Door Handle



Front Heater  
Mounting Screws  
(4 sets)

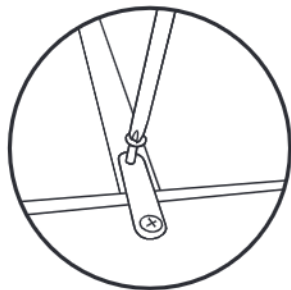

Wall Security Brackets  
(located installed in wall)



Glass Security  
Brackets (2 sets)

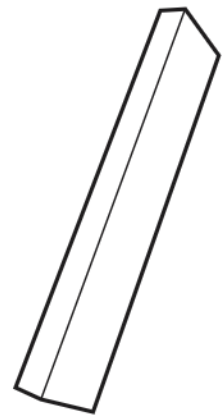

Wood piece  
(2 pieces)

# Assembly Instructions

Assembly of the sauna requires two adults to complete. Please read the instructions thoroughly before and during assembly to ensure proper installation of the unit. If you encounter any problems or have questions during assembly, please feel free to call our Customer Service department at 1-800-798-1779 or +1-510-601-1775.

## 1 - LOCATION OF SAUNA & INSTALLATION ORDER

When determining a location for your sauna, please keep in mind the following:

1. The main power cord on the sauna must be easily accessible.
2. The location must be dry and level.
3. Panels should be installed in the following order:
 

1) Floor	4) Right Side Wall	7) Wood Roof
2) Back Wall	5) Under Bench Support	8) Glass Roof
3) Left Side Wall	6) Bench	9) Front Wall Glass

## 2 - PLACING FLOOR PANEL

1. Place the bottom floor panel on the ground near the location you will using the sauna. Make sure the front of the floor is in the desired location of the door. The two plugs and the door magnet indicate the front of the sauna.

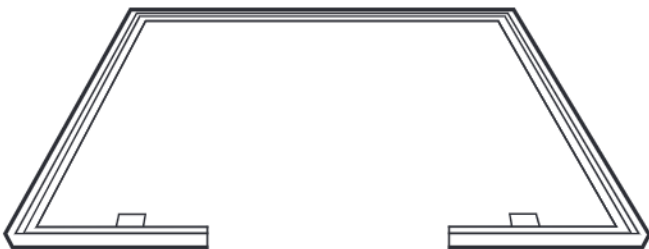

## 3 - CONNECTING THE BACK PANEL TO THE FLOOR PANEL

1. Connect the back panel to the floor panel by lining up the back panel on the groove of the floor panel. Connect the cables coming out of the floor to the cables coming out of the back wall panel as you insert the wall into the groove.

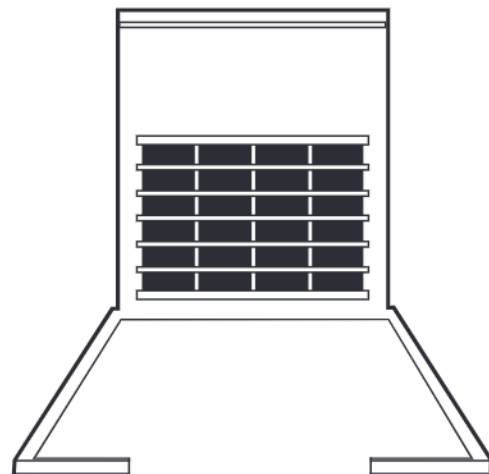

# Assembly Instructions Cont'd

## 4 - CONNECTING SIDE WALLS

The side wall panels will be connected to the back wall by connecting together the installed brackets. There are "+" brackets and "-" brackets on the side of each panel. The side walls will be installed as follows:

1. Place the left side wall in the slot in the floor. Lift the side wall up about 4" (10cm) higher than the backwall panel (See Picture 1).
2. Place the side wall panel against the back wall (See Picture 2), then slide down side wall panel until the two panels are equal height. (See Picture 3).
3. If the panels are not equal height or there is an obvious gap between the two panels, this means they are not properly attached and you should try again.



Picture 1

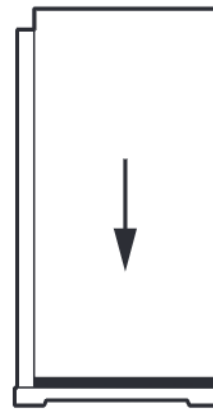

Picture 2

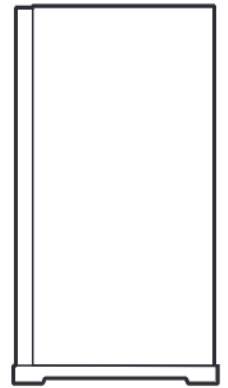

Picture 3



If the panels still seem too tight to come down all the way, try backing off the bracket screws by one half turn with a Phillips head screwdriver on the female bracket.

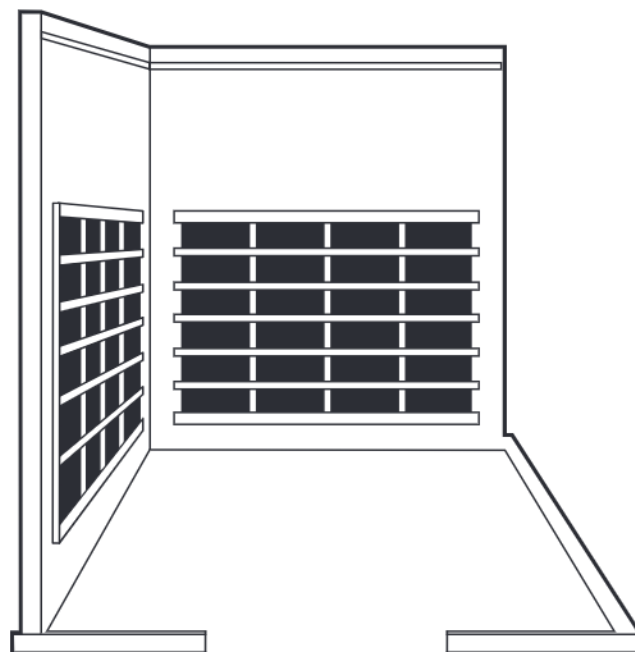

Left Side Wall Installed



# Assembly Instructions Cont'd

## 5 - INSTALLING RIGHT SIDE WALL

Install the right side wall in the same manner as the left side wall.

1. Place the right side wall in the slot in the floor. Lift the side wall up about 4" (10cm) higher than the backwall panel (See Picture 1).
2. Place the side wall panel against the back wall (See Picture 2), then slide down side wall panel until the two panels are equal height. (See Picture 3).
3. If the panels are not equal height or there is an obvious gap between the two panels, this means they are not properly attached and you should try again.

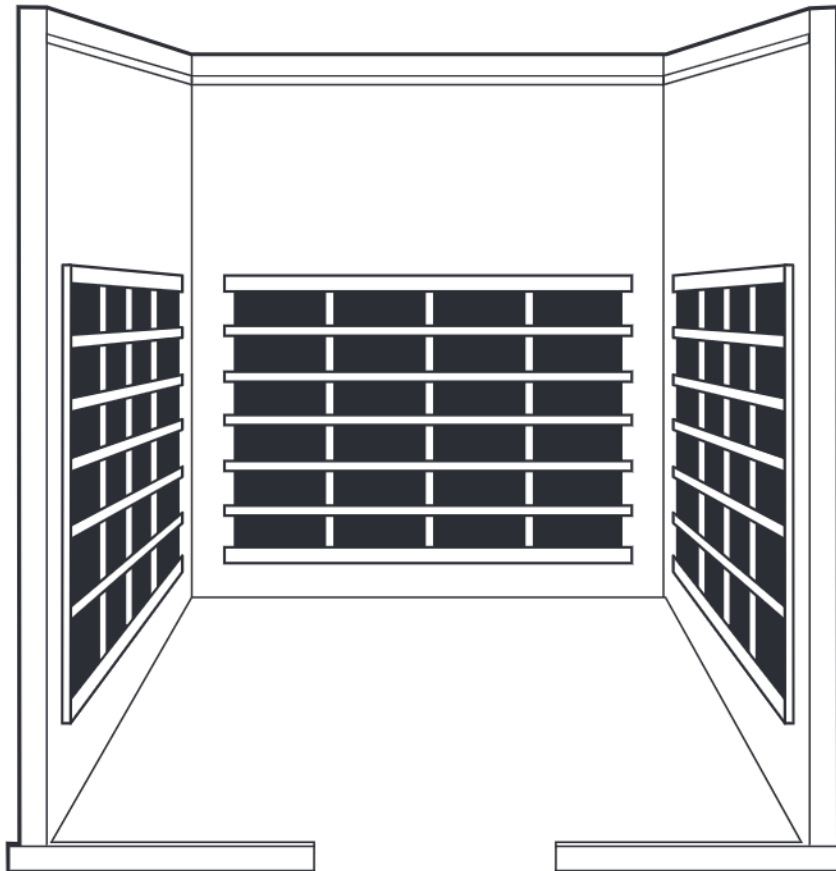

Right Side Wall Installed

# Assembly Instructions Cont'd

## 6 - INSTALLING WOOD PORTION OF ROOF

1. Set the wood portion of the roof on the back roof guide. Be sure to slide the roof back against the back wall.

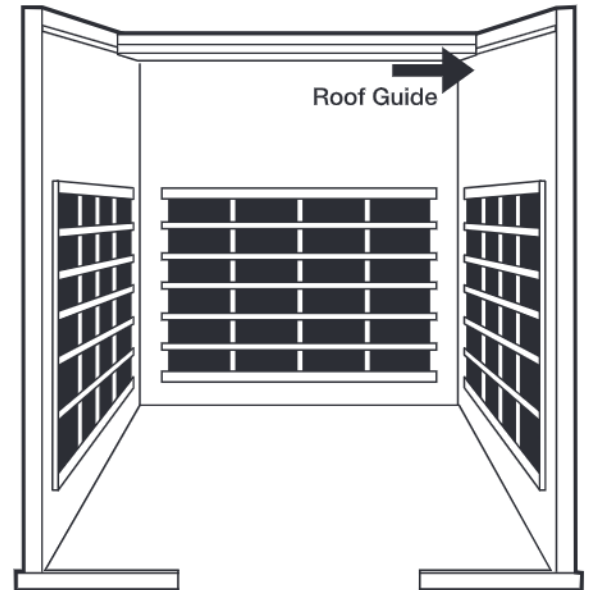

## 7 - INSTALLING GLASS PORTION OF ROOF

1. Place the glass roof portion on the front roof guides. Be sure that it is pushed firmly back against the wood roof portion.

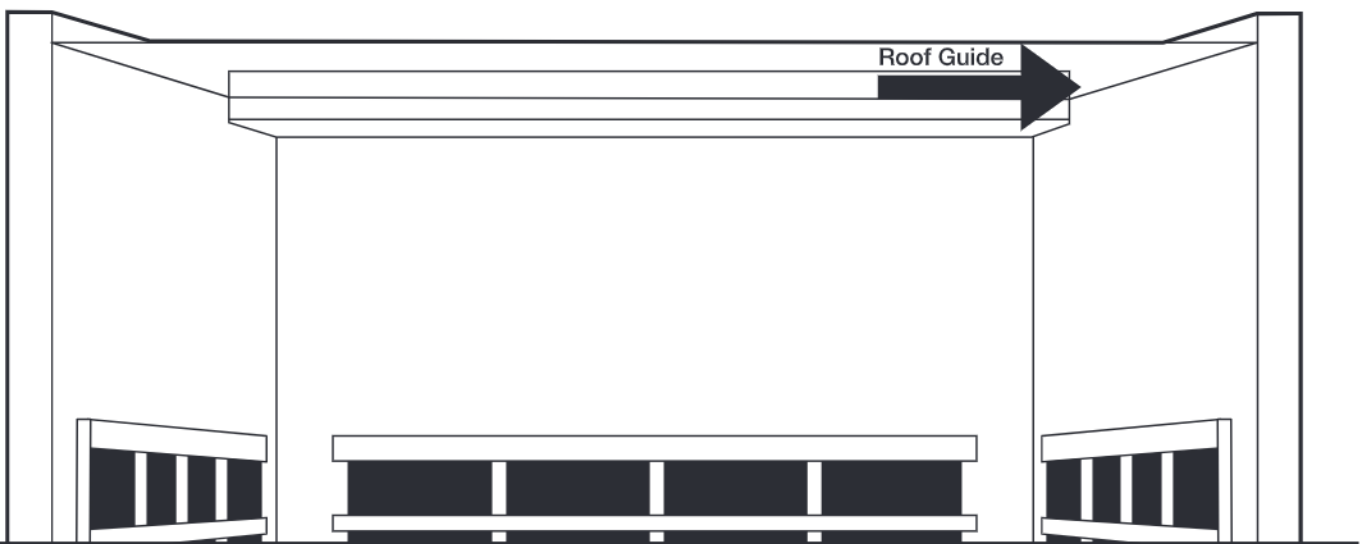

# Assembly Instructions Cont'd

## 8 - INSTALLING WALL LOCKS



**THIS STEP IS VERY IMPORTANT. PLEASE DO NOT OMIT THIS STEP.**

1. The side walls must be secured to the back wall and wood roof piece using the attached eye hooks.
2. Screw in one of the eye hooks between the left side wall and backwall and one between the right side wall and backwall.
3. Secure one of the eye hooks between the left side wall and top front of the wood roof piece and one between the right side wall and the top front of the wood roof piece.

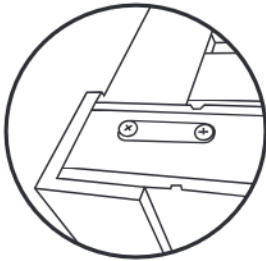

Attach eye hook so that it is screwed into both the side walls and back walls.

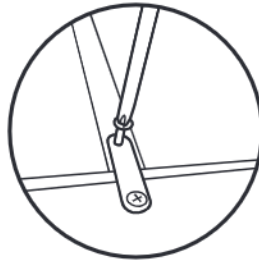

Attach the eye hook so that it is screwed into side walls and the wood roof piece.

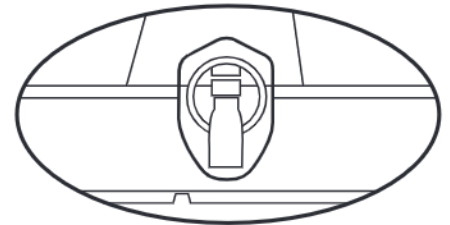

## 9 - ASSEMBLING BENCHES

1. The Sanctuary Y - FS comes with two benches. The benches are identical. Please located the pieces for one bench as shown below:



(4 x)

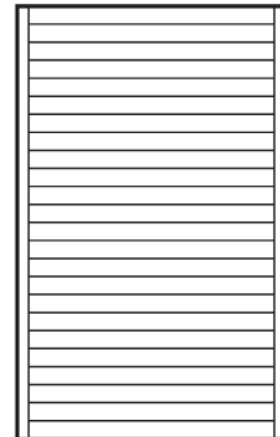
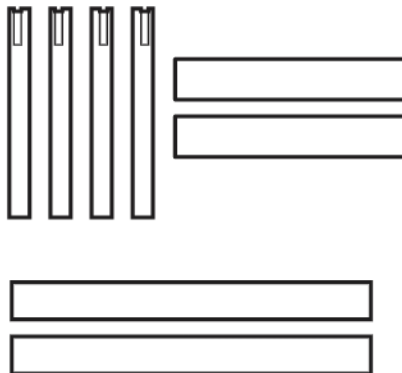

(4 x legs, 2 x long side supports, 2 x short side supports)

# Assembly Instructions Cont'd

## 9 - ASSEMBLING BENCH'S CONTINUED

2. Line up the two long side support, two short side supports and four legs as shown in the image below:

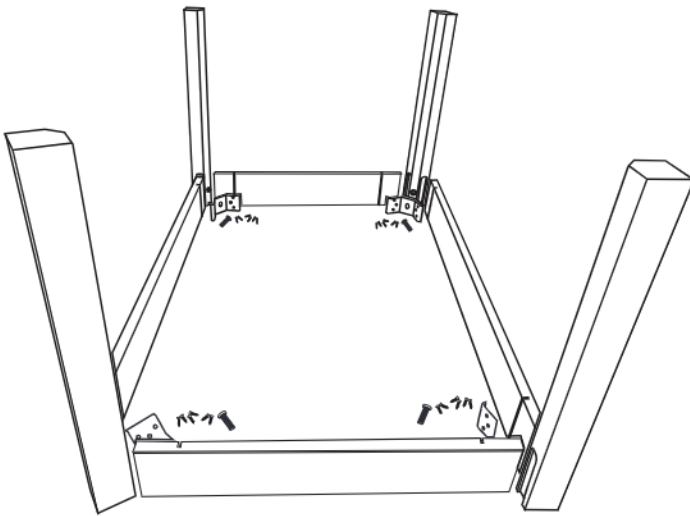

3. Insert the side pieces into the slots in the legs

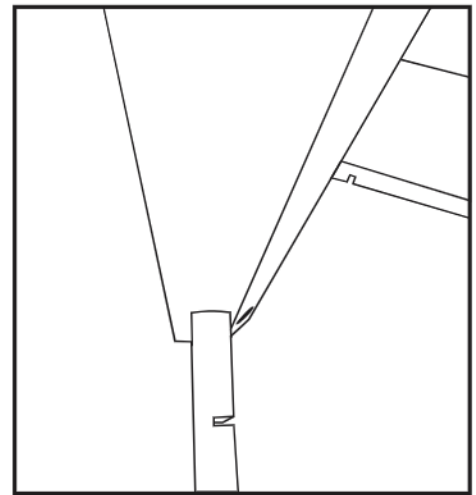

4. Place one of the metal brackets in one of the corners of the bench support frame as show below:

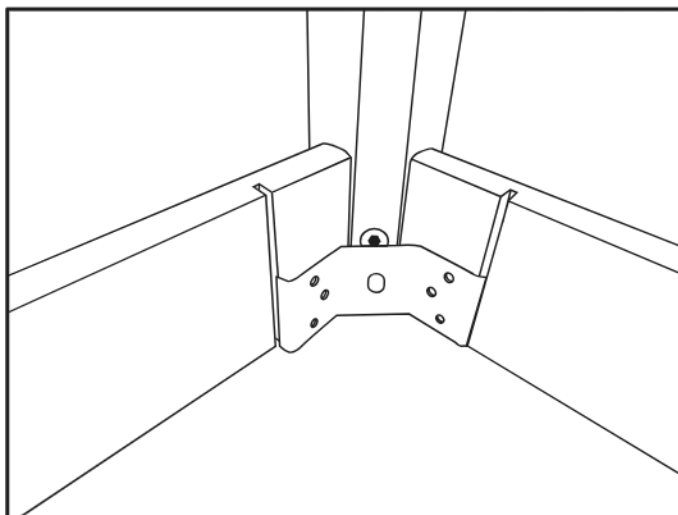

# Assembly Instructions Cont'd

## 9 - ASSEMBLING BENCH'S CONTINUED

5. Line up the hole in the bracket with the screw thread in the leg piece and screw one of the bolts into the leg piece. Be sure that the bracket ends are inserted into the groove of the side support pieces.

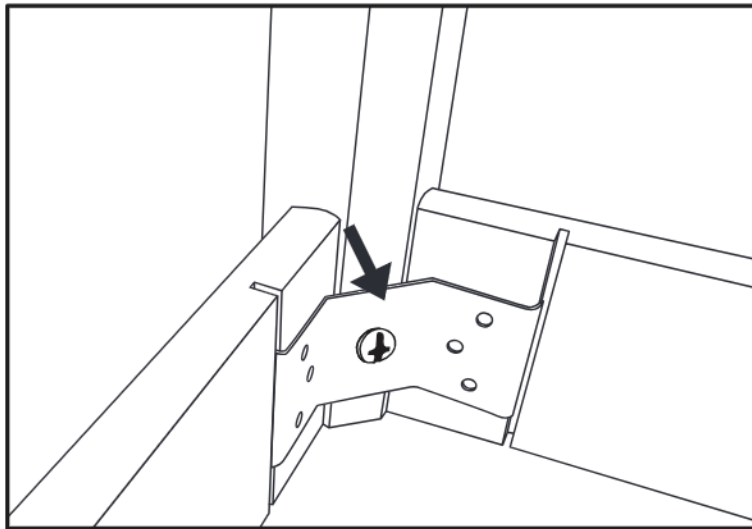

6. Repeat this for all four legs.
7. Using 6 x wood screws for each bracket, screw the wood screws into the bracket to secure it to the side support pieces.

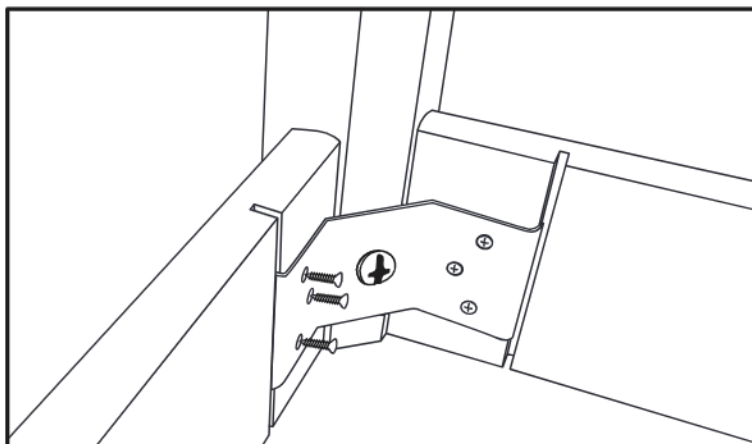

# Assembly Instructions Cont'd

## 9 - ASSEMBLING BENCH'S CONTINUED

8. Locate the bench top

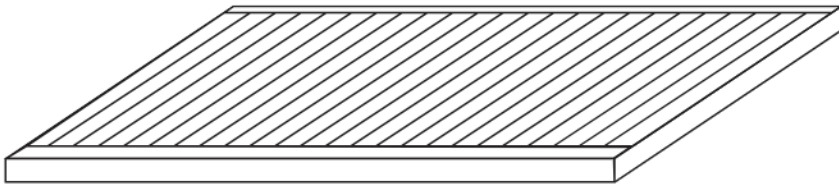

9. Turn the bench top upside down as in the drawing below:

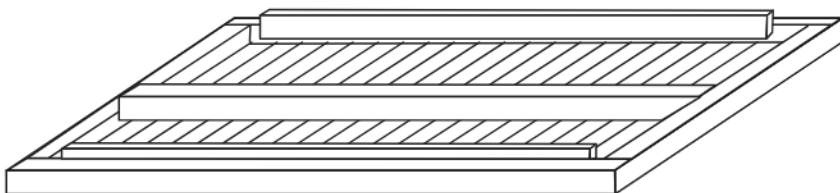

# Assembly Instructions Cont'd

## 9 - ASSEMBLING BENCH'S CONTINUED

10. Place the frame support piece completed in steps 1-7 on the bottom side of the bench top.

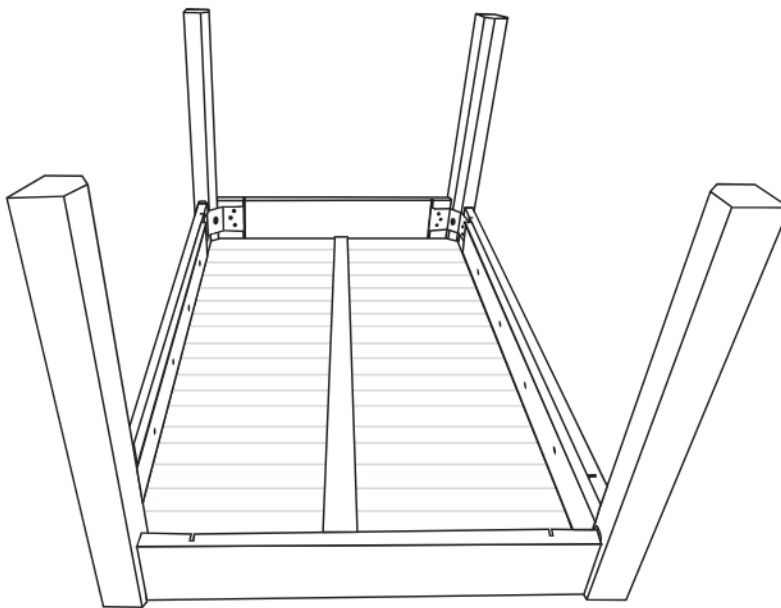

11. Locate the bag with 6 x wood screws.

# Assembly Instructions Cont'd

## 9 - ASSEMBLING BENCH'S CONTINUED

12. Screw the bench top into the long side supports using the pre-drilled holes as guides.

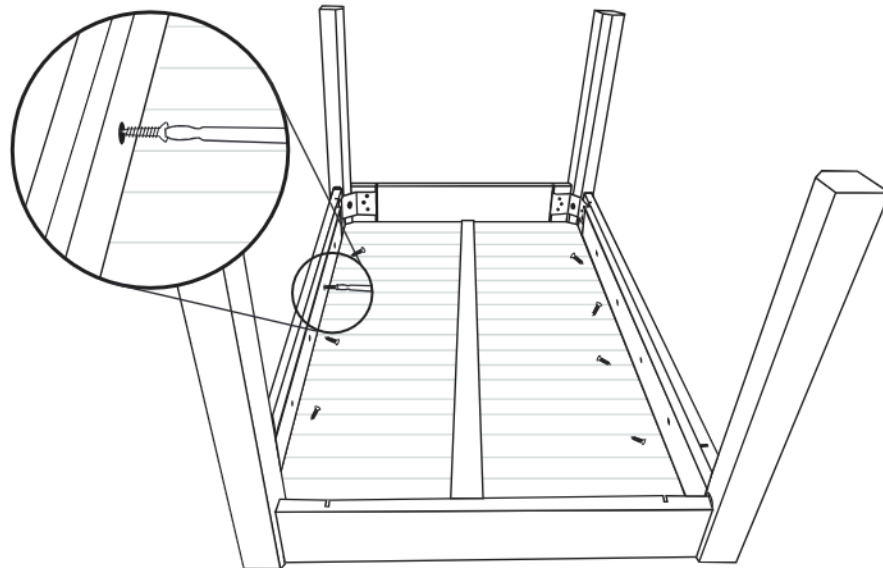

13. The bench is complete

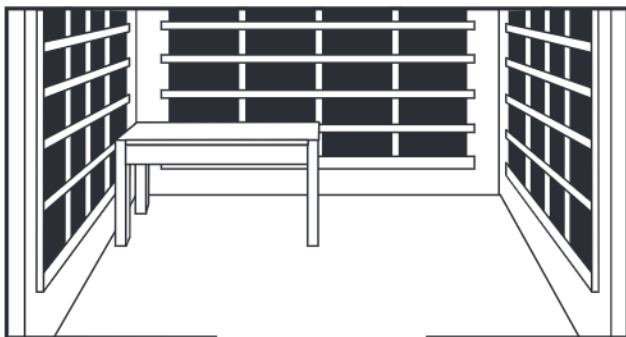

14. Repeat steps 1-13 for the second bench.

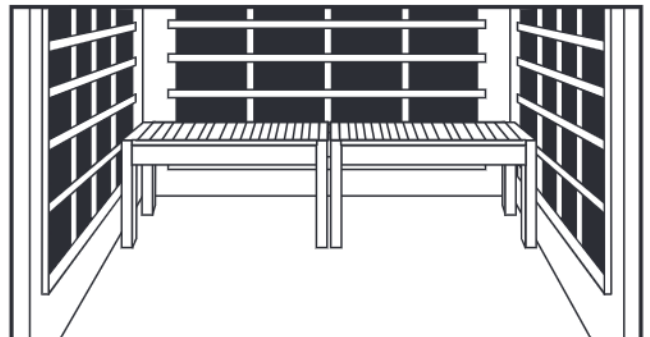



# Assembly Instructions Cont'd

## 10 - INSTALLING RIGHT SIDE GLASS WINDOW

1. We recommend using two people to move the glass door and right window piece. Place the glass door with left window in the groove in the floor and slide it securely into place against the left wall. It may help to put the corner of the glass in place first then put the rest of the glass in the slot. **Until this piece is secured as in step 2 below using the included brackets, please hold this piece in place.**
2. Secure the left side glass window to the roof glass using the included brackets. You will see pre-drilled holes in both the front glass and roof glass. One person should hold the outside piece while the other person screws in the bolt.

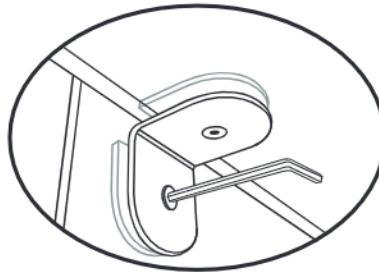
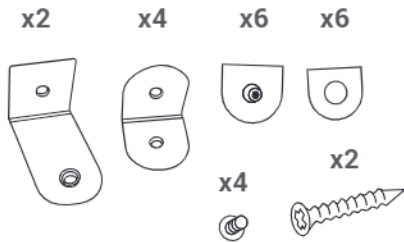

3. Secure the outer-most Side Wall-Mounted L Shape Brackets into the wall using the screws provided.

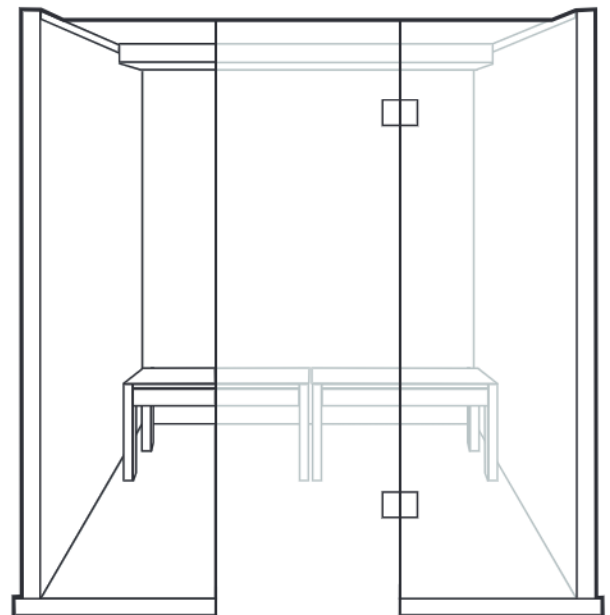
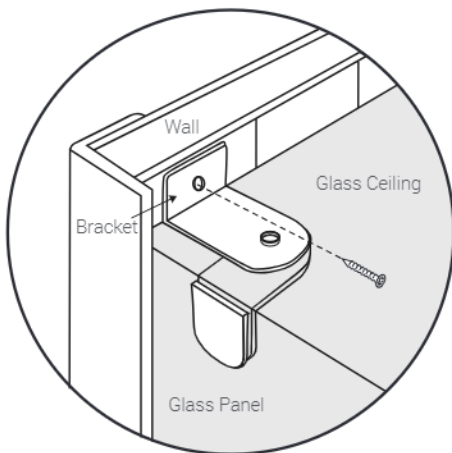

Door and Right Front Wall Installed

# Assembly Instructions Cont'd

## 11 - INSTALLING LEFT SIDE GLASS WINDOW

1. Open the door of the sauna to allow room to place the left side glass window.
2. Place the left side glass window and push it against the left side wall so it is securely in place. Until this piece is secured using the included brackets, someone should hold the piece in place.
3. Secure the left front glass window to the roof glass using the included brackets. You will see pre-drilled holes in both the front glass and roof glass.
4. Secure the outer-most Side Wall-Mounted L Shape Brackets into the wall using the screws provided.

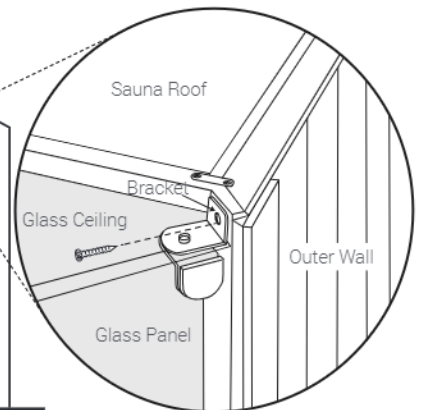
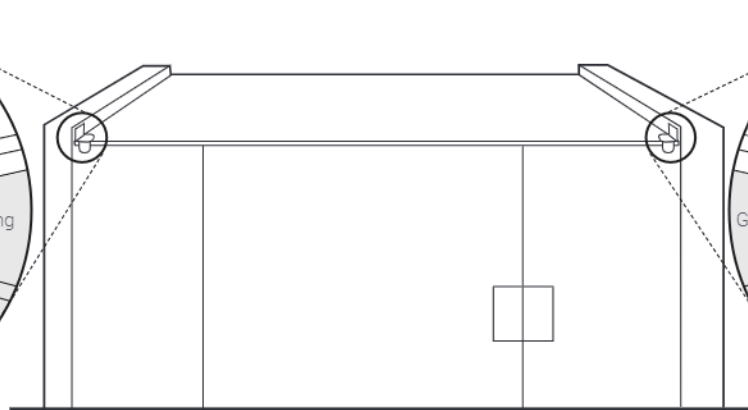
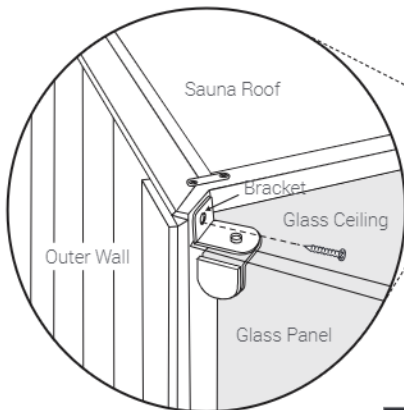
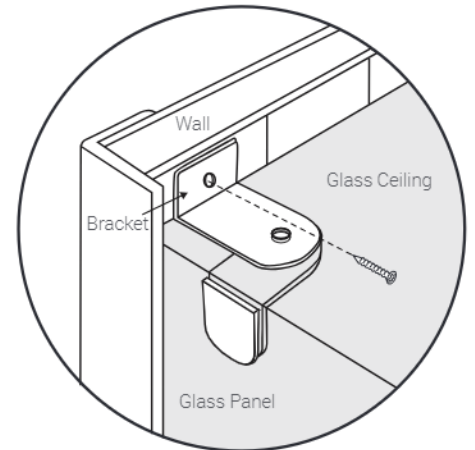
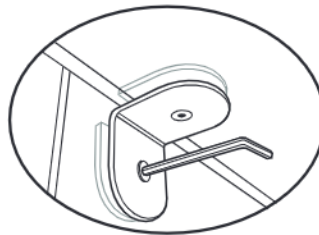
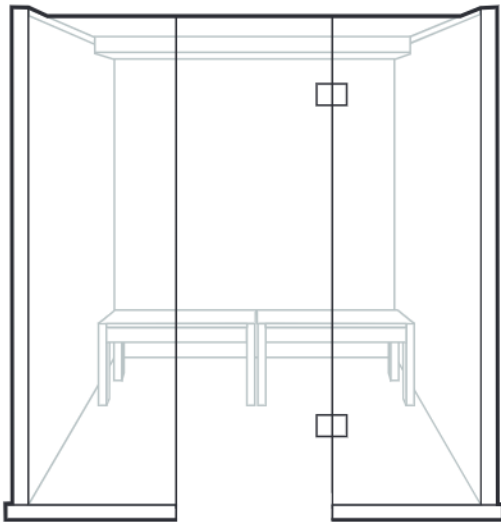

Front Wall Installed

# Assembly Instructions Cont'd

## 12 - CONNECT HEATERS IN ROOF

1. Locate the "trap" doors that open in the wood roof.
2. Connect the black and white cables that that come out of the side wall to the connector located in the wood roof.
3. Connect the green ground wire that come out of the side wall to the green ground wire that is in the wood roof.  
Push the wiring inside the roof area and close the roof door compartments.
4. In the left side wall compartment, there will be two connectors: 1) Heater connector. 2) Keypad connector. The heater connector is a two wire connector. The keypad connector is a seven wire connector.

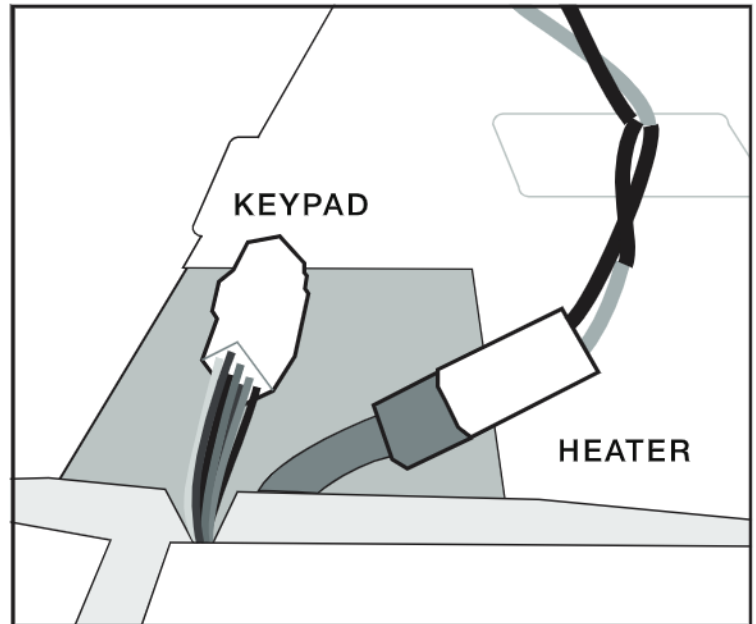

BE SURE TO MATCH THE COLORS IN THE CONNECTORS.  
THE BLACK WIRE SHOULD MATCH UP WITH THE BLACK WIRE, ETC.

## 13 - INSTALLING DOOR HANDLE

1. Locate the door handle.
2. Attach the door handle using the enclosed screws.

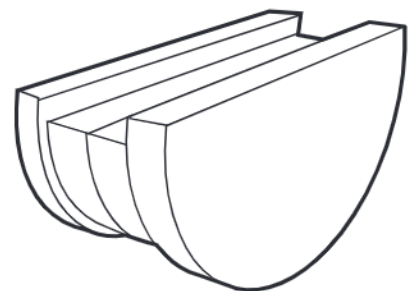

**Note:** If you are using a tablet or smartphone to control your sauna, the door handle will act as both the door handle and tablet/smartphone holder when the door is closed.

# Assembly Instructions Cont'd

## 14 - INSTALLING FRONT HEATERS

1. Locate the two front heaters.
2. Align the left front heater and plug the connector that comes out of the bottom of the heater into the plug coming out of the in the floor.
3. Align the the hole in the back of the heater with the hole in the front wall glass. Using the enclosed screws and washers, secure the heater to the glass through the pre-drilled hole. One washer will be placed on the inside and one on the outside glass. The heater will be secured with these screws in two locations.
4. Repeat this step for the right front heater.

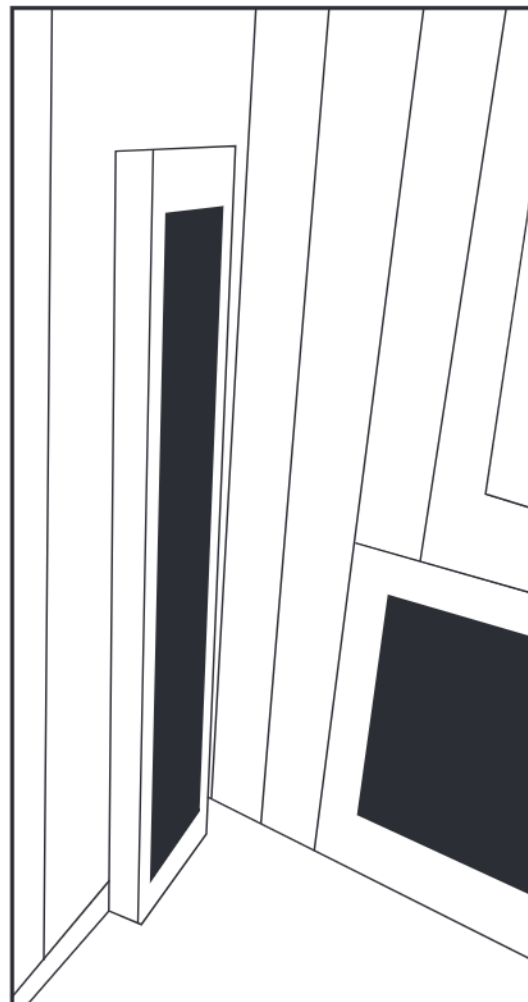
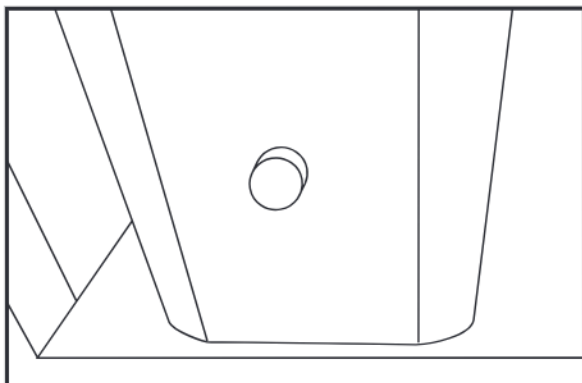
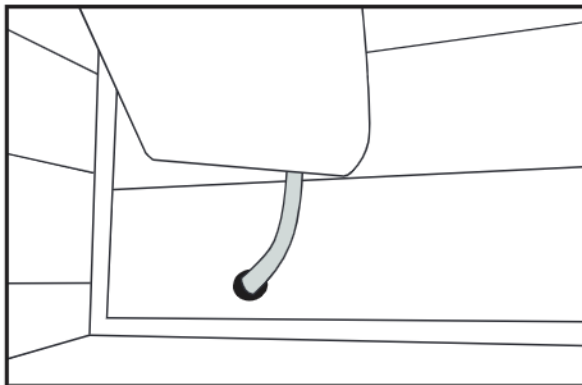

Front  
Heater  
Installed

# Assembly Instructions Cont'd

## 14 - INSTALLING FRONT HEATERS



### Warning Notice

The infrared heaters in your sauna are a potential BURN HAZARD. Do NOT touch the infrared heaters when they are in operation and allow to cool before servicing.

## 15 - LOCATING AND PLUGGING IN POWER CORD

The power cord comes out of the roof of the sauna. If you are standing facing the sauna, it comes out of the rear left corner of the roof. Open the trap door to access the power cord and run the cord down the back of the sauna. The power cord will plug into the appropriate electrical receptacle.



**Note:** We do not recommend using an extension cord for your sauna. Please plug the sauna directly into the wall receptacle.

# Assembly Instructions Cont'd

## 16 - INSTALLATION IS COMPLETE

Installation of your sauna is now complete. Using a damp cloth, wipe out the sauna to remove any excess saw dust that may have settled on the wall & floor panels and the heater panels.

Please refer to usage instructions located later on in this manual.

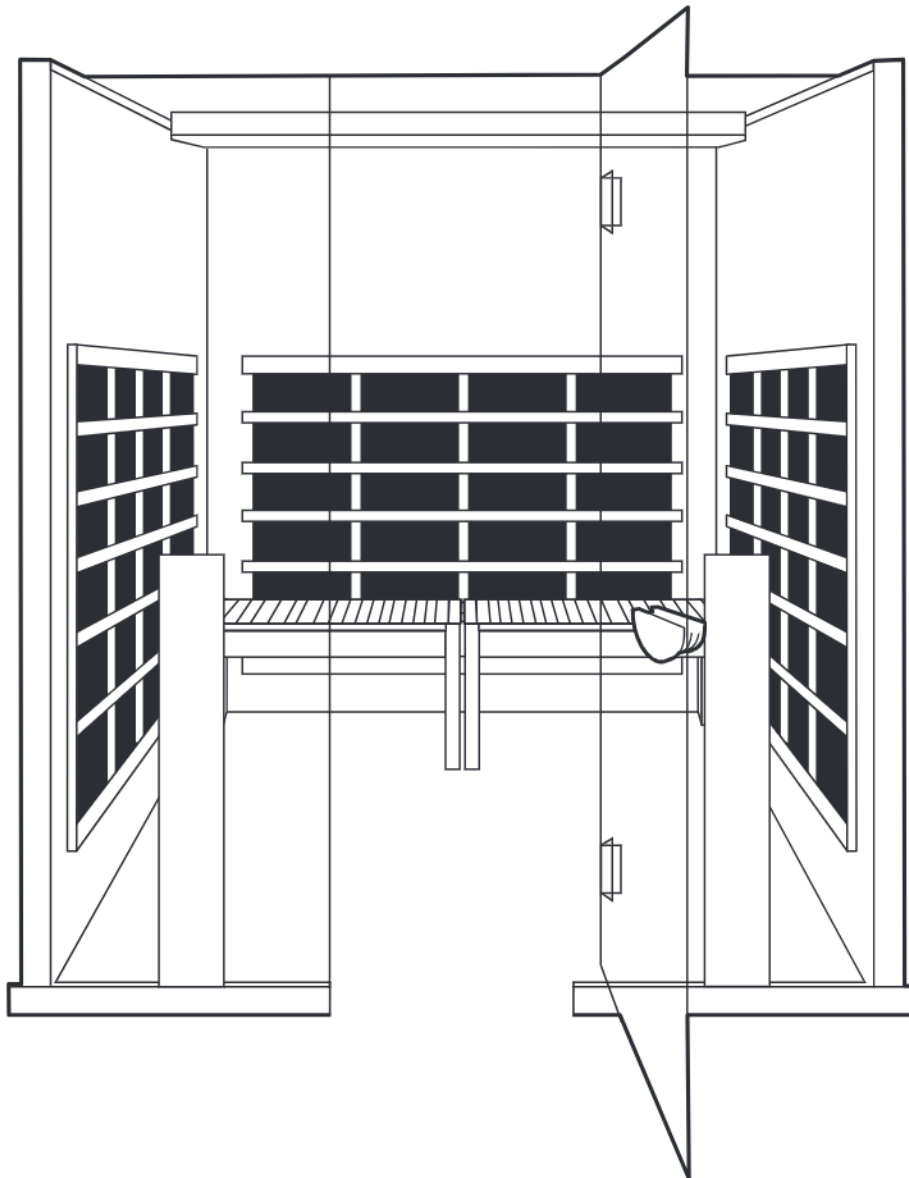

**04**

# **Halotherapy Solutions Halogenerator**

Installation Instructions - - - - - 56

## INSTALLING THE HALOGENERATOR

1. Align the Halotherapy Generator with the hole in the side wall of the cabin and push the spout through the hole in the wall.

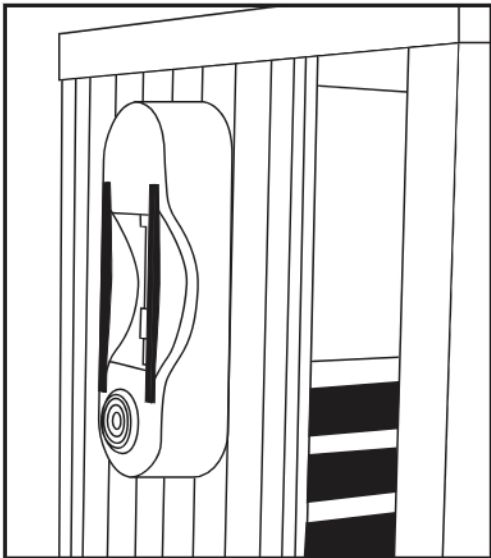

2. The spout should be pushed as far through the hole as possible.

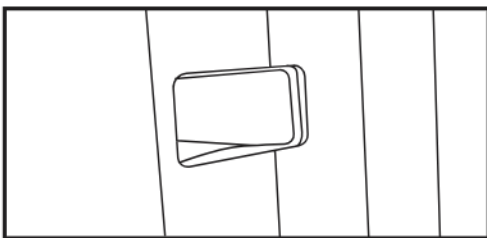

3. Using the two provided screws, screw the unit into the side wall of the cabin.

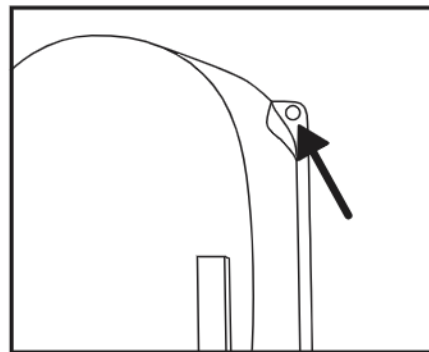

4. Connect the round plug coming out of the bottom of the unit to the receptacle in the wall.

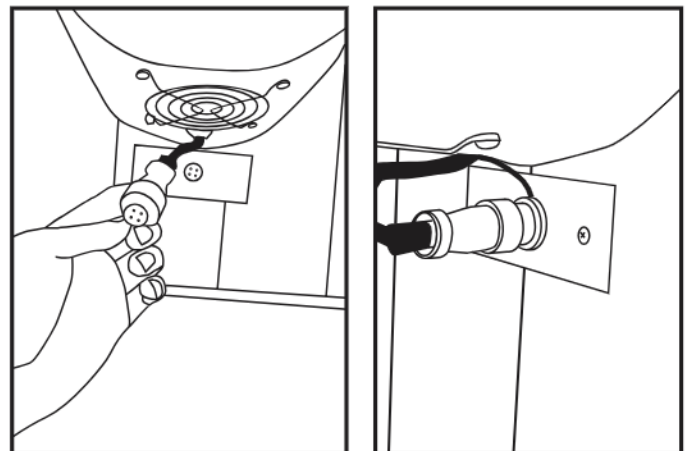

5. On the inside of the cabin, position the salt catcher over the hole in the wall with the bottom of the catcher below the halogenerator spout. Screw the catcher into the wall.

Installation of the Halogenerator is complete.



# Using Your Halo IR Control Panel

## USING YOUR HALOTHERAPY CABIN

When connected to the properly grounded power source, your Halo IR Cabin will turn ON to the set temperature and count-down with a few pushes of the Power button.



### System On/Off

- 1) Press the "POWER" button once to turn on the sauna.
- 2) Your session will automatically end after the programmed timer expires.
- 3) Press the "POWER" button at any time turn off the sauna.



### Sauna Session Time

You can set the duration of your sauna session for a maximum of 60 minutes. Press the TIME UP or TIME DOWN buttons to increase or decrease your desired sauna session time in 5 minute increments. When you have reached your desired time, release the button.

### Controlling the Set Temperature

You can program your sauna for a maximum temperature of 175°F (80°C). Press the TEMP UP/DOWN (+/-) buttons to set the desired temperature. When the display shows your desired temperature, release the buttons. Press either the TEMP UP or TEMP DOWN buttons during your sauna session to manually control the desired cabin temperature.

\*See "Instructions For Use" on next page for recommendations.

# Using Your Halo IR Control Panel

## USING YOUR INFRARED SAUNA

### Fahrenheit & Celsius

You can alternate between Fahrenheit and Celsius by pressing the F/C button on the keypad.

### Inside Light

1. Press the button labeled "INSIDE" to turn on or off the Interior light.

### Reservation

You can preset your sauna to turn on up to 36 hours in the future:

1. Press the POWER button to turn on your sauna.
2. Press the RESERVE button.
3. The time and temperature will begin to flash.
4. Press the TIME UP button to set the number of hours ahead you would like your sauna to turn on.
5. The range is 1 - 36.
6. Set the maximum set temperature by pressing the TEMP UP or TEMP DOWN button.
7. The keypad will flash and the time will count down in one hour increments until the sauna turns on.
8. To cancel the reservation, press the "POWER" button once to turn off the sauna.

### AUX

The AUX button will be used to control additional features that can be added to your sauna. The instructions to use these features will be included when the item is purchased.

### Controlling the Halotherapy Unit

1. Press the "SALT" button to turn on the Halotherapy unit. TURBO mode will be activated automatically and will provide a burst of salt for 2 seconds every 2 minutes.
2. You can increase the amount of salt being dispersed by adjusting the "TURBO" burst and time in between bursts by doing the following (Please note this only has to be done if you want more salt which is not necessary for efficacy, but may help with the user perception. It is strongly recommended to not go above 4 seconds for the turbo):
  - Hold the TURBO Button down for 5 seconds.

# Using Your Halo IR Control Panel

## USING YOUR INFRARED SAUNA

- The burst duration of 2 seconds will be displayed on the left side of the keypad display and the time in between burst of 2 seconds will be displayed on the right side of the keypad display.
- Press the TEMP + or TEMP - buttons to adjust the burst time from 1 - 6 seconds.
- Press the TIME UP / TIME DOWN buttons to adjust the time between bursts from 1-5 minutes.
- After setting the "TURBO" function, wait 5 seconds to exit programming mode.

### Protocols

In addition to the above manual Halotherapy settings, you can also select from four Halotherapy Protocols:

**Protocol 1:** Infrared Only - Press the "PROTOCOL" button one time. The number "1" will display on the keypad display. Wait for the green turbo light to come on in the middle of the control panel. Then, press the SALT button and the halogenerator will turn on. After the session is over, typically 20 minutes, press the SALT button again to turn off the halogenerator.

**Protocol 2:** Halotherapy & Low Temperature Infrared - Press the "PROTOCOL" button two times. The number "2" will display on the keypad display. The Halotherapy unit will turn on and the infrared heat will turn on to a set temperature of 88°F (31°C) until the end of the session. The temperature inside the cabin will not exceed 88°F (31°C).

**Protocol 3:** Infrared then Halotherapy - Press the "PROTOCOL" button three times. The number 3 will display on the keypad display. The infrared heat will turn on to a set temperature of 88°F (31°C). When the cabin temperature reaches 88°F (31°C), the Halotherapy unit will turn on until the end of the session.

**Protocol 4:** Halotherapy & Full Temperature Infrared - The Halotherapy unit will turn on and the infrared heat will turn on with a set temperature of 158° (70°C). When the cabin temperature inside the cabin reaches 104°F (40°C), the Halotherapy unit will turn off. The infrared heaters will stay on and continue to heat the cabin. \*\*Please note: The cabin temperature will not reach the 158° (70°C). For maximum infrared therapy benefit you want continuous infrared heat on your body. When the cabin temperature reaches the set temperature, the infrared heaters will turn off. By setting the set temperature to 158° (70°C) the heaters will stay on continuously as the cabin temperature will not reach 158° (70°C).

# Using Your Halo IR Control Panel

## USING YOUR INFRARED SAUNA

### Keypad Lock

The keypad can be locked to prevent it from being turned on or off or the temperature adjusted. There are two locking functions:

1. **Lock Entire Keypad:** Hold down the **SALT** light button for 10 seconds. The keypad is now locked except the inside light can be turned on and off and the SALT button will still work.

Press the **SALT** button again for 10 seconds to unlock the keypad.

2. **Lock Keypad - Light Button Will Continue To Work:** Hold down the **OUTSIDE** light button for 5 seconds. This will lock the entire keypad except for the light buttons. To unlock the keypad, repeat the step above.



**Note:** With the keypad locked, the time will continue to count down and the sauna will turn off when the time is expired.

### 16 Hour Mode

Your sauna can be run continuously for 16 hours without turning it back on. You can also use the timer on the keypad to time customer sessions. When 16 hour mode is active, the sauna will stay on continuously for 16 hours at the set temperature.



**Note:** If you change the set time on the keypad, the timer will continue to count down, but the sauna will not shut off.

### To activate 16 hour mode:

1. Set the sauna temperature to Celcius.
2. Set the temperature to 10°C
3. Press the "Inside Light" button for 5 seconds

# Using Your Halo IR Control Panel

## USING YOUR INFRARED SAUNA

### Audio System

Your Halo IR Cabin is equipped with stereo speakers that can be accessed by Bluetooth.

1. Your Halo IR Cabin is Bluetooth ready. To connect audio via Bluetooth:
  - A) Open your Bluetooth enabled phone, tablet or computer and search for surrounding Bluetooth devices to find a device called **Infrared Sauna**. The pairing code for this device is **0000**.
2. There is a 3.5mm jack in the charging compartment that is connected to the speakers in your sauna. You can connect any audio to the speakers using this connection.

### Aromatherapy Diffuser

1. The included Aromatherapy Diffuser plugs into the outlet in the side wall. See the drawing below:

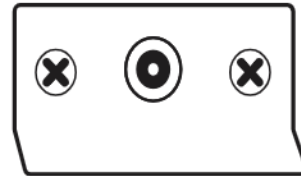

### 12v Auxiliary Outlet

A 12v auxiliary outlet is located on the left side wall of the cabin. You can use this to plug in additional devices to your Halotherapy cabin.

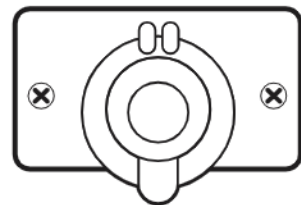

### Floor Plug

The plug in the floor will allow you to add additional electronic options for your unit. By default, the plug is not energized. Please contact your sales person for additional options and how to activate the plug.

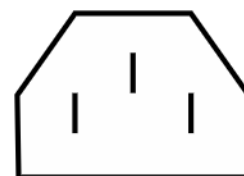

# Important Safeguards

## USING YOUR INFRARED SAUNA

### Chromotherapy

Color light therapy can benefit your well being. Chromotherapy or Color Light Therapy is the science that uses the seven colors of the light spectrum. The seven colors have the ability to affect the vibrations of the body various frequencies. For optimal health, we all need the light of the sun. We receive light from the sun which is divided into 7 main groups of rays which are absorbed by our bodies.

Chromotherapy works on various energy points to help balance your body using the full spectrum of visible light. Color and light have been utilized by healers for thousands of years. Color therapy possibly has roots in Ayurveda, ancient Egyptian culture and traditional Chinese healing.

Alternative medicine practitioners who use chromotherapy often relate the seven colors of the color spectrum to specific body areas. Color has a profound effect on us on all levels, physical, mental, emotional and spiritual.

**The chromotherapy light is controlled by pressing the buttons on the INCLUDED REMOTE CONTROL.**

1. Press the "POWER" button to turn on the Chromotherapy light.
2. Press the "MANUAL" button to manually select a color.
3. Press the "AUTO" button and the Chromotherapy light will automatically change through the various colors.
4. Press the "INTENSITY" up or down buttons to control the brightness of the Chromotherapy light.

The available color in the Chromotherapy light have been specifically selected based on their wavelength:

- 1) Red: Activates the circulatory and nervous systems.
- 2) Strong Green: Provides anti-infectious, anti-septic and regenerative stimulation.
- 3) Strong Blue: Lubricates joints. Helps address infections, stress, nervous tension.
- 4) Orange: Energized and eliminates localized fat. Helps address asthma and bronchitis.
- 5) Green: Acts as a relaxant.
- 6) Blue: Stimulates muscle and skin cells, nerves and the circulatory systems.
- 7) Strong Yellow: Strengthens the body and acts on internal tissue.
- 8) Strong Indigo: Helps address eye inflammation, cataracts, glaucoma and ocular fatigue.
- 9) Strong Pink: Act as a cleanser, strengthening the veins & arteries.
- 10) Yellow: Reactivates and purifies the skin. Helps with indigestion and bodily stress.
- 11) Indigo: Activates and eliminates impurities from the blood stream.
- 12) Violet: Relaxes the nerves & lymphatic system. Addresses inflammation and urinary illness.

# Important Safeguards

## IMPORTANT SAFEGUARDS

1. **READ INSTRUCTIONS** - All safety and operating instructions should be read before the sauna is installed & operated.
2. **RETAIN INSTRUCTIONS** - The safety and operating instructions should be retained for future reference.
3. **HEED WARNINGS** - All warnings on the sauna should be adhered to.
4. **FOLLOW INSTRUCTIONS** - All operating and usage instructions should be followed at all times.
5. **CLEANING** - Unplug the sauna from the wall outlet before cleaning. Do not use liquid cleaners or aerosol cleansers inside the sauna. Use a damp cloth for cleaning.
6. **ATTACHMENTS** - Do not use attachments that are not recommended by the manufacturer as they may cause hazard.
7. **WATER OR MOISTURE** - Do not use this product near water-for example near a bathtub, in a wet basement, or near a swimming pool or similar area.
8. **GROUNDING OR POLARIZATION** - This sauna is intended for use with a 3-wire properly grounded power socket Do not defeat the safety purpose of the supplied line cord and plug.
9. **POWER SOURCES** - This product should be operated only from the required type of power source indicated on the marking label. If you are not sure of the type of power supplied to your home, consult your local power company.
10. **POWER-CORD PROTECTION** - Power supply cords should be routed so they are not likely to be walked on or pinched.
11. **LIGHTNING** - For added protection for this product during a lightning storm, or when it is left unattended and unused for long periods of time, unplug it from the wall outlet.
12. **OVERLOADING** - Do not overload wall outlets and extension cords as this can result in a risk of fire or electrical shock.

# Important Safeguards

## IMPORTANT SAFEGUARDS

13. **SERVICING** - Always unplug this product from the wall outlet before servicing the product.
14. **POWER SUPPLY** - Do not remove power supply covers. No user-serviceable parts are located inside the power supply.
15. **REPLACEMENT PARTS** - When replacement parts are required, only use parts specified by the manufacturer. Unauthorized substitutes could result in fire, electrical shock or other hazards.
16. **SAFETY CHECK** - Upon completion of any service or repairs to this product by a service technician, ask the technician to perform safety checks make certain that the product is in proper operating condition.





