

For Services and Support



TEL

86-755-21612590
1-833-629-4832 (North America)



EMAIL

SUPPORT@TOPDON.COM



WEBSITE

WWW.TOPDON.COM



FACEBOOK

@TOPDONOFFICIAL



TWITTER

@TOPDONOFFICIAL



TOPDON

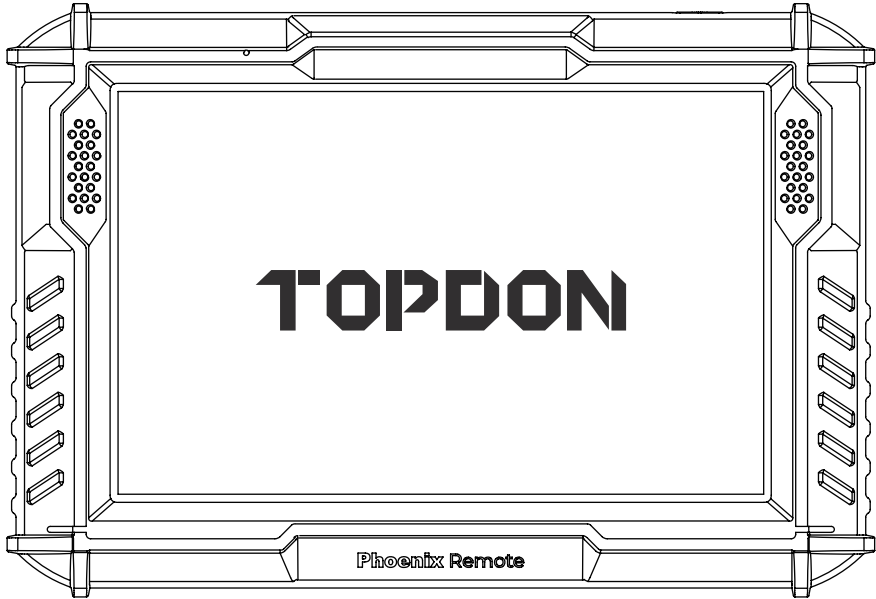

Phoenix Remote

Smart Automotive Diagnostic System

USER MANUAL

Content

Welcome	3
About.....	3
Package List	3
Compatibility	3
Notice.....	4
General Information of OBDII (On-Board Diagnostics II).....	4
Diagnostic Trouble Codes (DTCs)	4
Product Descriptions	5
Preparation & Connection.....	6
Operation Introduction.....	11
Technical Specification.....	34
Warnings.....	35
Cautions.....	35
FAQ.....	36

Welcome

Thank you for purchasing TOPDON automotive diagnostic tool Phoenix Remote. Please read and understand this user manual prior to the operation.

About

TOPDON Phoenix Remote features comprehensive diagnostic capabilities. The accuracy of test readings, expanded vehicle coverage, improved speed and an abundance of user-friendly nature make this diagnostic tablet stand out in its class and give mechanics and professionals a great deal of help in their diagnostic work.

Package List

- Phoenix Remote
- OBDI Adapter BOX Transfer Line
- OBDII Extension Cable
- Cigarette Lighter Cable
- Type-C to USB Cable
- Battery Clamps/Cable Set
- Power Adaptor
- User Manual
- Password Letter
- Non-Standard OBDII Adapter*10
- Fuse ($\varphi 5 \times 20\text{mm}$)*4
- Fuse ($\varphi 6 \times 30\text{mm}$)*2
- Ethernet Cable

Compatibility

TOPDON Phoenix Remote is compatible with the following protocols:

- ISO 9142-2
- ISO 14230-2
- ISO 15765-4
- K/L-Line
- SAE-J1850 VPW
- SAE-J1850 PWM
- CAN ISO 11898
- Highspeed
- Middlespeed
- CAN FD Protocol
- Lowspeed and Singlewire CAN
- GM UART
- UART Echo Byte Protocol
- Honda Diag-H Protocol
- TP 2.0
- TP 1.6
- SAE J1939
- SAE J1708
- Fault-Tolerant CAN
- And More

Notice

Phoenix Remote may automatically reset while being disturbed by strong static electricity. THIS IS A NORMAL REACTION.

This user manual is subject to change without written notice.

Read the instruction carefully and use the unit properly before operating. Failure to do so may cause damage and/or personal injury, which will void the product warranty.

General Information of OBDII (On-Board Diagnostics II)

The OBDII system is designed to monitor emission control systems and key engine components by performing either continuous or periodic tests of specific components and vehicle conditions, which will offer three pieces of such valuable information:

- Whether the Malfunction Indicator Light (MIL) is commanded "on" or "off";
- Which, if any, Diagnostic Trouble Codes (DTCs) are stored;
- Readiness Monitor status.

Diagnostic Trouble Codes (DTCs)

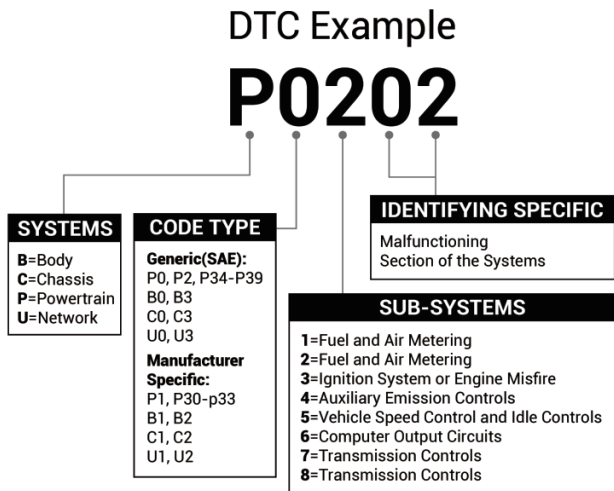

Product Descriptions

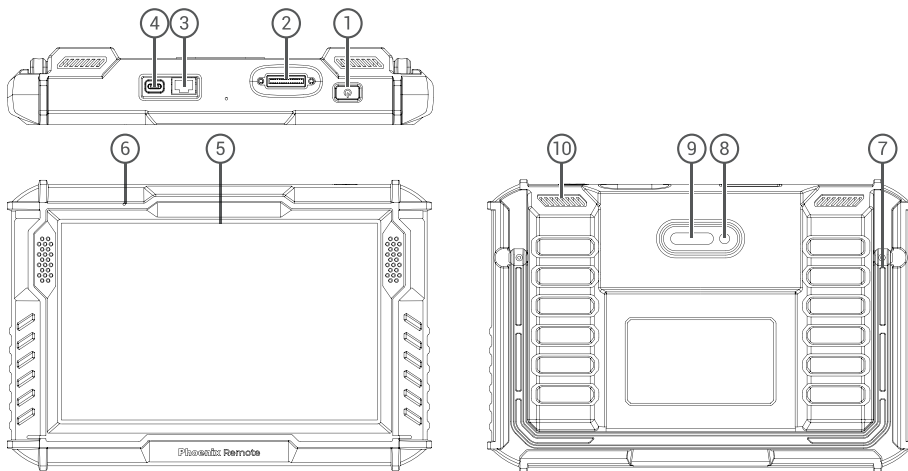

NO.	Name	Descriptions
1	Power Button	<ul style="list-style-type: none"> • Hold the button for 3 seconds to turn on the device. • Hold the button for 3 seconds again, it will pop-up a menu to select options: Shutdown or Restart. • Hold the button for 8 seconds, the device will force to restart again. • Press once to activate the device.
2	Diagnosis interface	Plug in the diagnostic cable whose OBD 16-pin connector is linked the DLC of the vehicle.
3	Ethernet interface	Through this interface, the device can be connected to Ethernet
4	Type C Charging Slot	For charging the tablet.
5	10" Touchable Screen	Show test results.
6	Microphone	Sound input for acquisition and noise reduction.
7	Adjustable Stand	Keep the tablet standing at the desk, or hang the tablet on the steering wheel.
8	Rear Camera	Snapshot the view ahead of the camera.
9	LED Lamp	Fill light for photographing.
10	Loudspeaker	Convert an audio signal into a corresponding sound.

Preparation & Connection

1. Turn the ignition off.

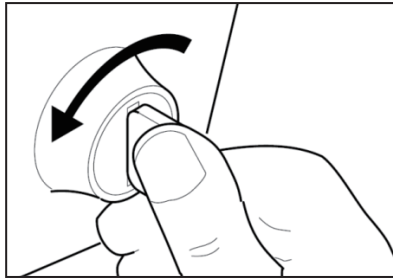

2. Locate the vehicle's DLC port.

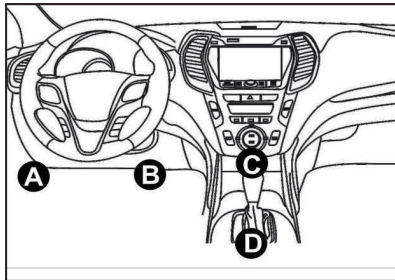

3. Plug the TOPDON Phoenix Remote into the vehicle's DLC port.

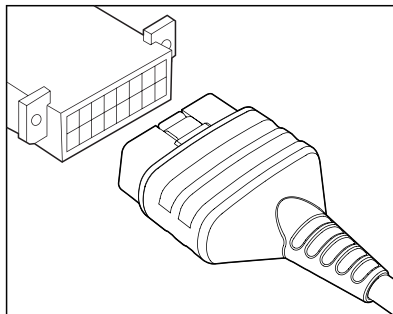

4. Turn the ignition on. The engine can be off or running.
5. Fully charge the Phoenix Remote, and hold the power button for 3 seconds to turn the tablet on. The tablet will start initializing and enter the following interface:



Note: Don't connect or disconnect any test equipment with the ignition on or engine running.

6. Language Setting

Select operating language in the following interface:

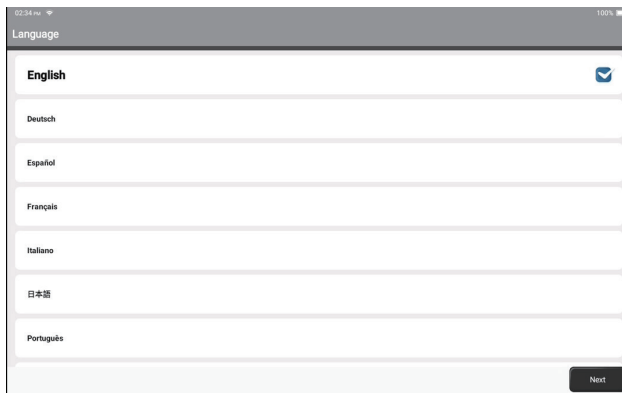

7. Choose Time Zone

Choose the time zone of your current location. The system will automatically configure the time according to the time zone you selected.

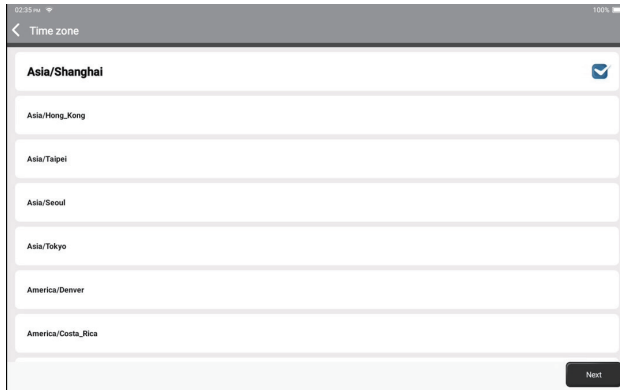

8. Connect Wi-Fi

The system will automatically search all available Wi-Fi networks. You can choose the Wi-Fi needed.

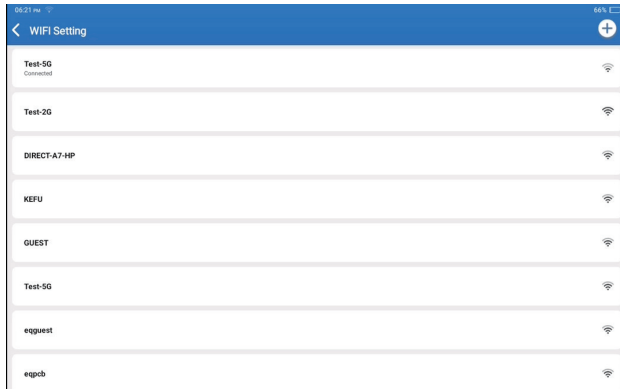

9. User Agreement

Please read all the terms and conditions of the user agreement carefully. Select "Agree with above terms".

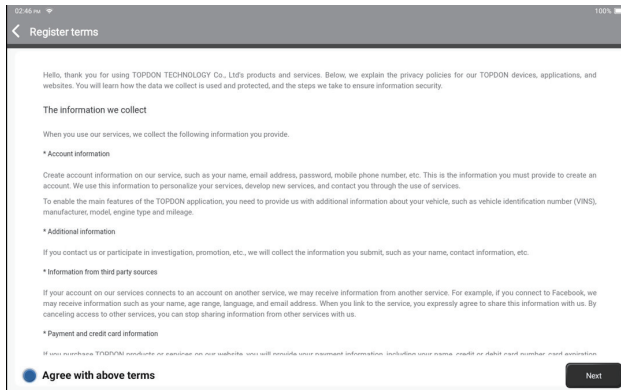

Tap "Next" to log in. The following page will appear:

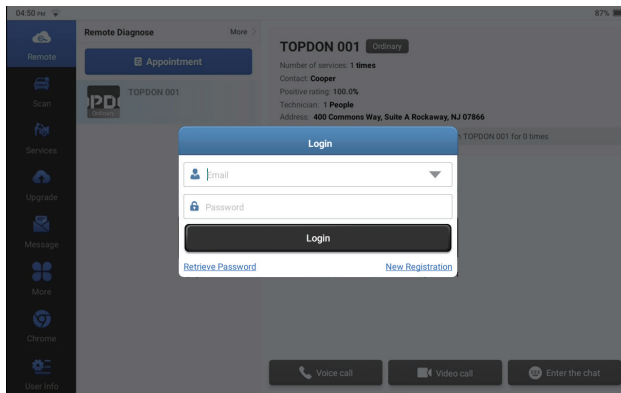

10. Create an Account

You can log in with an available TOPDON account, or register a new account with a valid e-mail address.

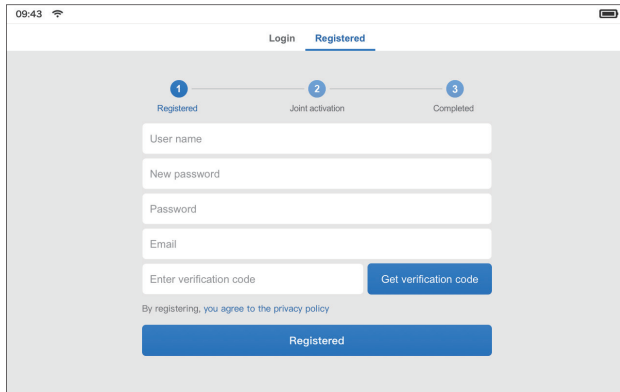

After inputting the information required, tap “Register”. The tablet will enter the device activation procedure.

11. Device Activation

Input the serial number and activation code to activate and bind the diagnostic device. Both the serial number and the activation code are available in the “Activation letter”. The activation procedure is necessary for using the Phoenix Remote properly.

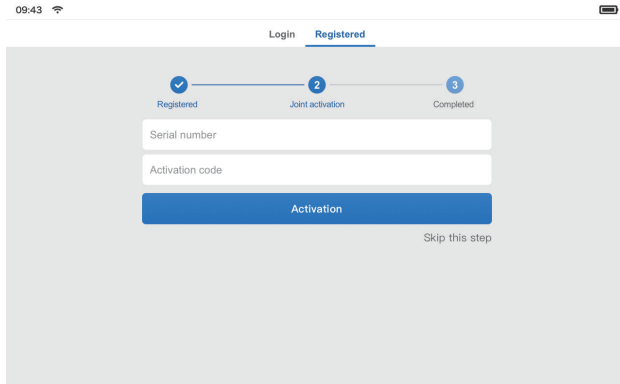

Tap “Activate” to finish the procedure, and get started to use Phoenix Remote.

Operation Introduction

TOPDON Phoenix Remote features an array of practical functions, including Remote, Scan, Services, Update, Message, More, Chrome and User Info.

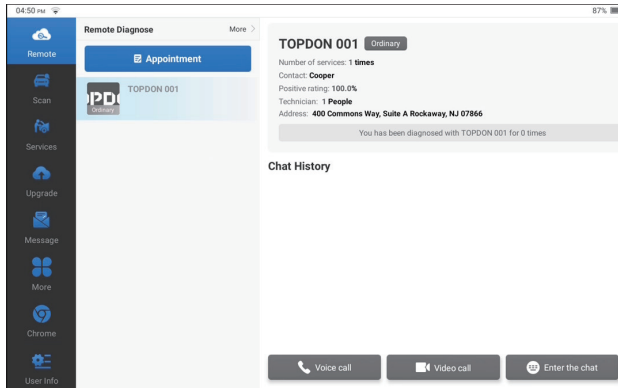

1. Remote

The user and the remote expert technician communicate the diagnosis requirements through this module, and the expert technician can use the third-party diagnostic equipment to provide professional remote diagnosis support after confirming the operation.

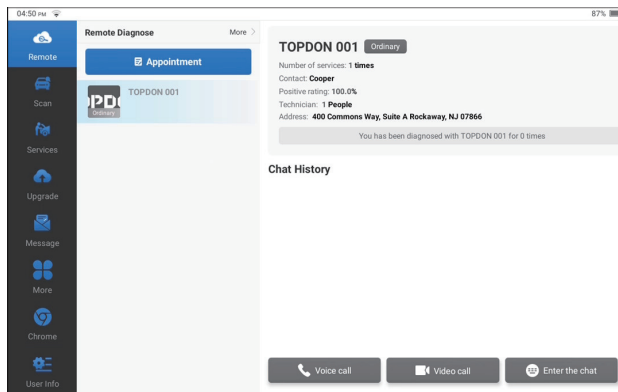

2. Scan(Diagnosis)

Tap "Scan" on the Home Menu. The following page will appear:

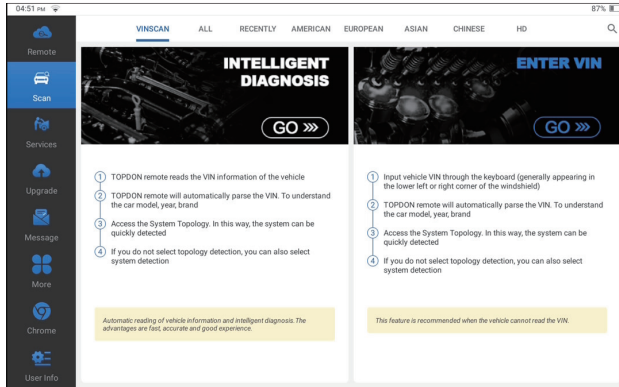

There are two ways in this module to get access to vehicle diagnostic functions.

2.1 Intelligent Diagnosis

Plug the device into the vehicle's DLC port.

Tap "Intelligent Diagnosis" on the Home Menu after connecting to the vehicle.

The tool will start the VINSCAN procedure, and automatically read the vehicle's VIN information, as shown below:

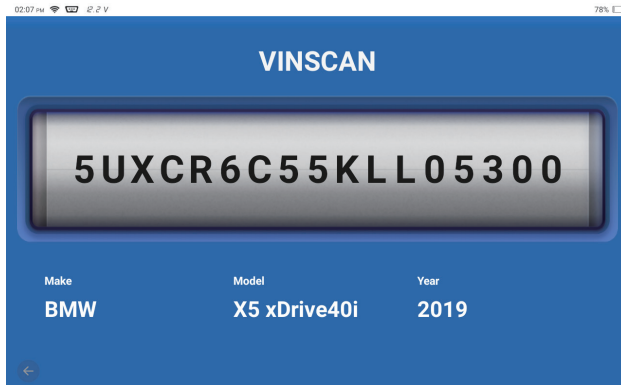

Note: A highly stable and solid network connection is required for successful VIN access.

2.2 Or, tap “Enter VIN”, the following page will appear:

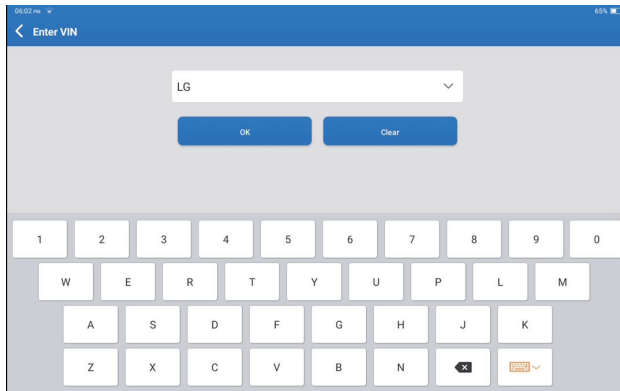

You need to input the vehicle's VIN manually.

Note: VIN characters need to be capital letters A through Z and numbers 1 through 0. However, the letters I, O, and Q won't be used in order to avoid misreading. No symbols or spaces are allowed in the VIN.

After reading the VIN information successfully, the following page will appear:

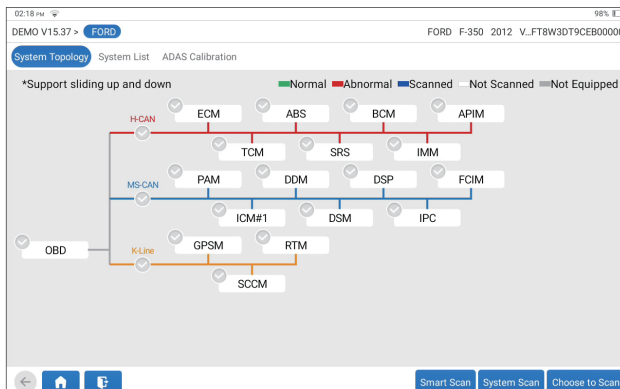

2.3 The second way is manually selecting the vehicle's make, model, and year.

Tap a corresponding diagnostic software logo on the following page:

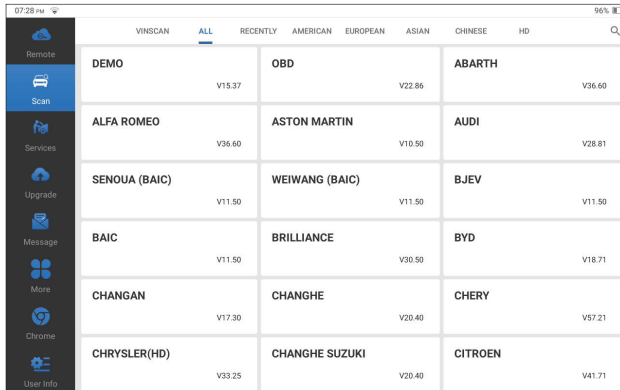

Take "Demo" as an example. The following page will appear:

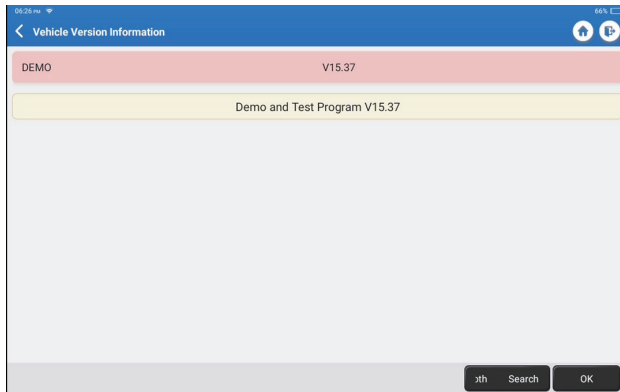

Select the diagnostic software version to continue.

The tablet will automatically navigate to the system and function selection menu:

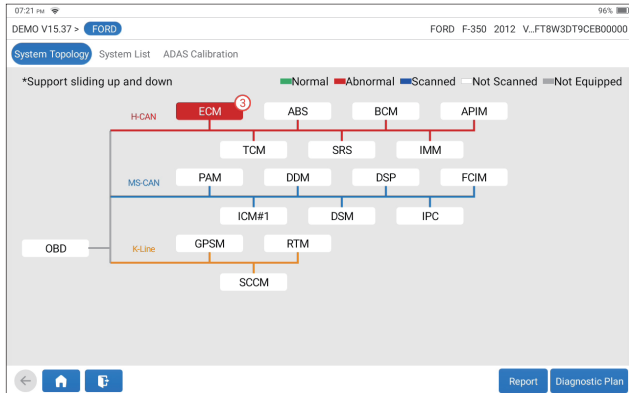

The interface has two display modes of system topology and system list, with the same functions. Switch according to personal preference.

2.3.1 Smart Scan

This function is used to quickly detect vehicles and view vehicle health reports (this item will only be displayed if the model diagnosis software supports this function).

Click "Smart Scan", the system starts to scan fault codes in each system and displays specific scan results.

The systems with DTC(s) will be shown in red, with the specific definition(s).

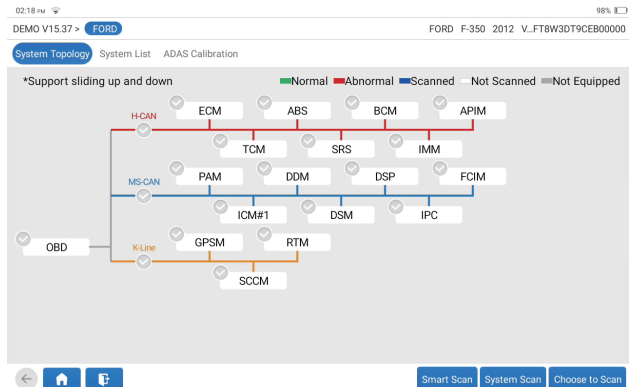

*Explanation of terms:

- Clear DTCs: Clear all Diagnostic Trouble Codes with one simple touch.
- Report: Save the current diagnosis result as a diagnosis report.

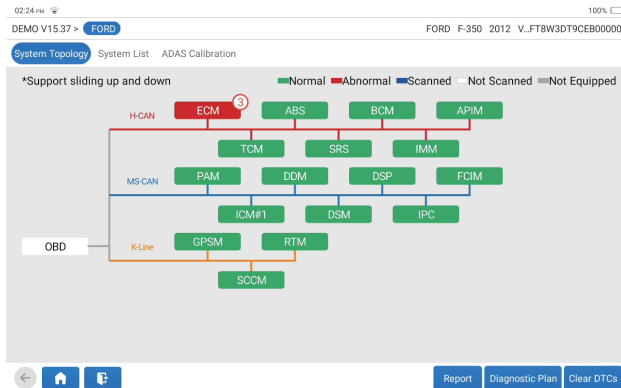

2.3.2 System Scan

This function will automatically scan all systems of the vehicle.

System Name	Status	Action
PCM (Powertrain Control Module)	Abnormal (3 DTCs)	Enter
TCM (Transmission Control Module)	Normal	Enter
ABS (Anti-lock Braking System)	Normal	Enter
RCM (Restraint Control Module)	Scanning	Enter
BCM (Body Control Module)	Not Scanned	Enter
IMMO (Immobilizer)	Not Scanned	Enter

FORD F-350 2012 VIN 1FT8W3D9CEB00000
 DEMO V15.37 > FORD

Pause

2.4 Choose to Scan

Scan the manually selected vehicle electric control system. Tap "PCM" ->"Enter" as an example to demonstrate. The following page shows the selection interface.

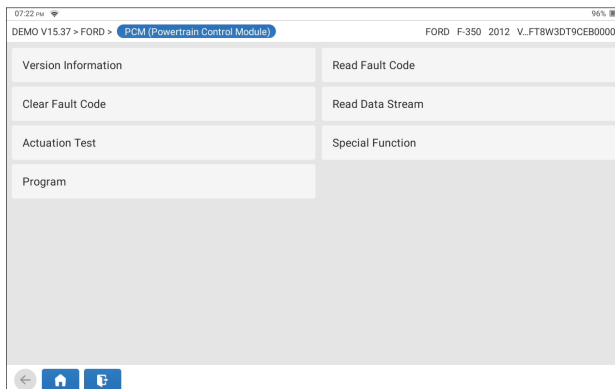

Note: This function will be available only when the diagnostic software supports it.

2.4.1 Version Information

This function reads the current version information of ECU.

2.4.2 Read Fault Code

This function can read the Diagnostic Trouble Codes (DTCs) in the ECU memory, helping quickly identify the cause of the vehicle breakdown. Tap "Read Fault Code". The screen will display diagnostic results.

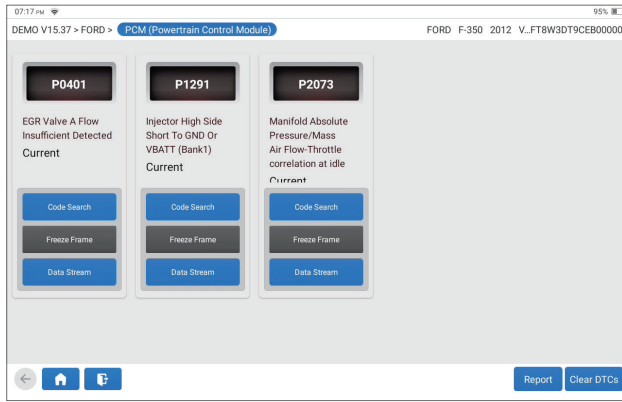

*Explanation of terms:

- Freeze Frame: Take a snapshot of specific data streams for verification when the DTC occurs.
- Code Search: Query DTC information through Google Chrome.
- Data Stream: Return to the data stream page.
- Report: Save the current diagnosis result as a diagnosis report.

2.4.3 Clear Fault Code

This function can clear the DTC of the ECU memory of the tested system.

2.4.4 Read Data Stream

This function can read and display real-time data and parameters. Tap "Read Data Stream". The following page will appear:

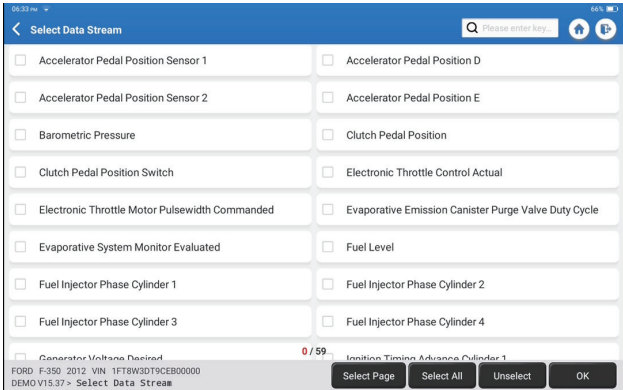

Select the data stream and tap "OK":

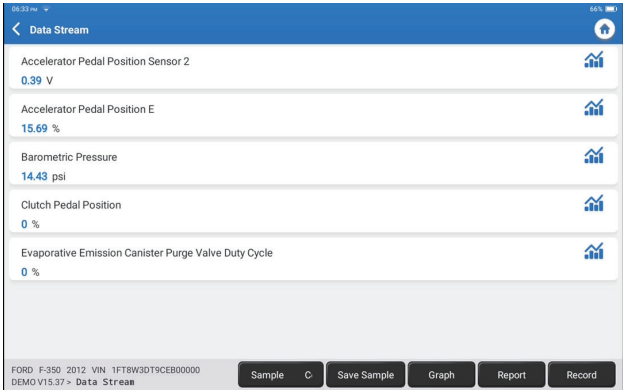



The system can display data streams in three modes:

- 1) Value (default): Shows parameters with numbers and lists.
- 2) Graph: Displays parameters with wave patterns.
- 3) Combine: The graphs can be merged for easier comparisons.

*Explanation of terms:

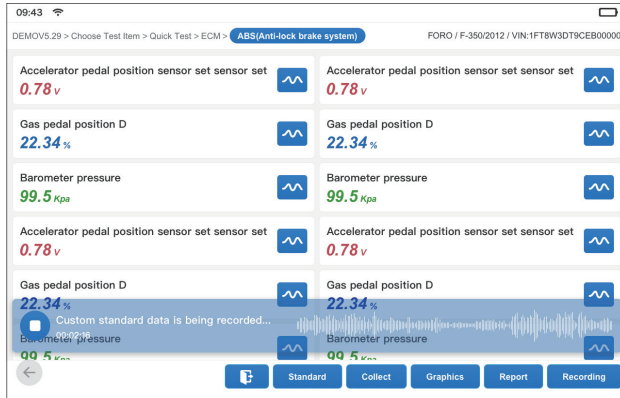
- Save Sample: You can save the current Data Stream as a Sample when the vehicle is running normally, and use this Sample Data Stream for future comparison and analysis. Tap "Save Sample" to start recording the sample data stream. The following page will appear:



Once the recording process is complete, tap "  " to end the recording. The following page will appear:

Name	Min Value	Max Value	Unit
Continuous Codes	2.0	⊗ 30.0	⊗
Left Front Wheel Speed Sensor(km/h)	0.0	⊗ 0.0	⊗ km/h
Left Rear Wheel Speed Sensor(km/h)	0.0	⊗ 0.0	⊗ km/h
Right Front Wheel Speed Sensor(km/h)	0.0	⊗ 0.0	⊗ km/h
Right Rear Wheel Speed Sensor(km/h)	0.0	⊗ 0.0	⊗ km/h

You can change the Min or Max value, and tap "Save" to save it as a Data Stream Sample. All Data Stream Sample files are stored in "User Info -> Data Stream Sample".

- Compare Sample: Tap "Compare Sample" to select the saved Data Stream Sample files. The following page will appear:

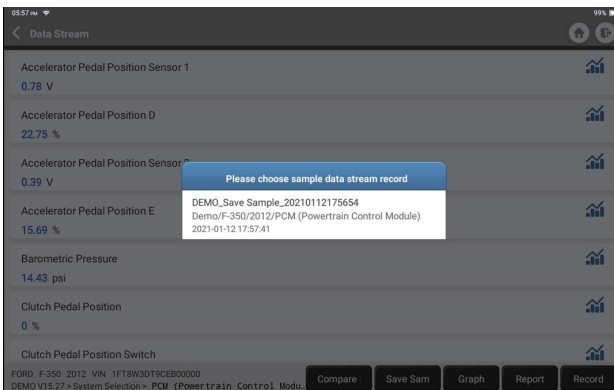

Tap the file you need. The following page will appear:

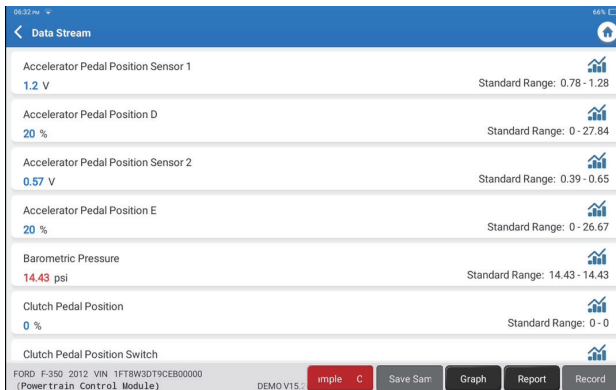

The Standard Range column will show the corresponding Data Stream Sample values for your comparison and analysis.

- Graph: To have the selected data streams (12 max items) displayed in waveform. Tap “Graph”. The following page will appear:

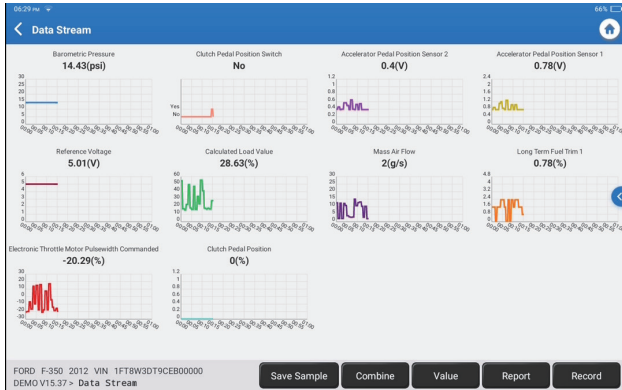



Tap “Combine” to merge graphs for easier comparisons (max 4 values can be merged).

Tap “Value” to view the data displayed in values.

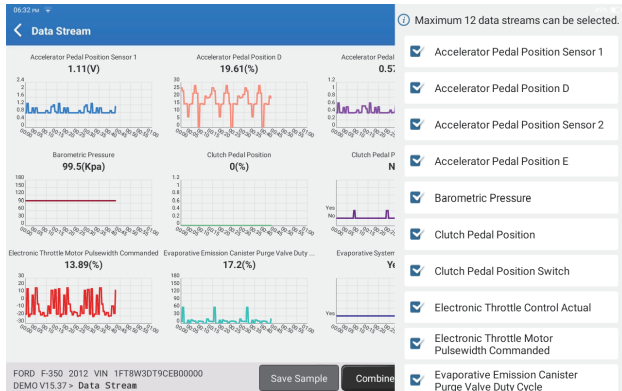
Tap “<” on the right side of the screen. The following page will appear:



You can select specific data stream options to be viewed on the left. Note: A maximum of 12 data streams can be displayed in this module.

- Report: To save the number of current data streams.
- Record: To record the diagnostic data for further analysis.
- : To view single data stream displayed in waveform. Tap "". The following page will appear:

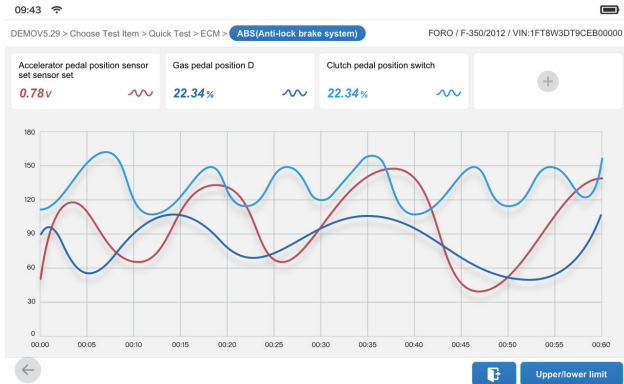

Tap "Min/Max" to define the maximum/minimum value. Once the value goes beyond the specified value, the data will be shown in red.

Tap "<" on the right side of the screen. The following page will appear:

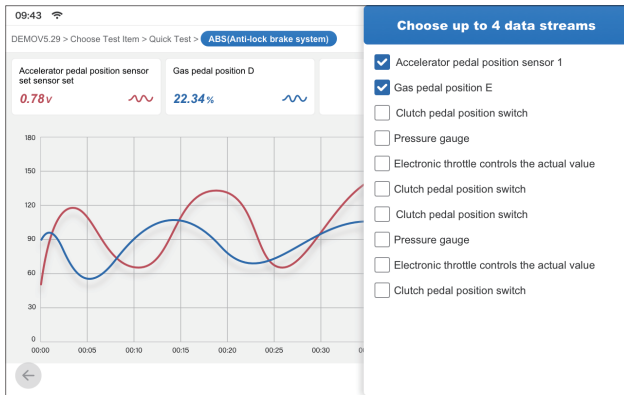

You can select specific data stream options to be viewed on the left. Note: A maximum of 4 data streams can be displayed in this module.

2.4.5 Actuation Test

This function is used to find out whether a specific subsystem or component in vehicles goes well or not, by testing output elements instead of checking in ignition status.

2.4.6 Special function

This function is used for data writing operation of electronic control unit. They all belong to this category, such as ECU data calibration, ECU Programming etc. Some Resetting functions are also included in this part.

3. Services

TOPDON Phoenix Remote is equipped with maintenance services to be very beneficial for technicians and mechanics working in the automotive repair industry.

3.1 OIL (Maintenance Light Reset)

This function enables you to reset the oil service lamp for the engine oil life system, which calculates an optimal oil life change interval depending on the vehicle driving conditions and weather events.

It needs to be performed in the following cases:

- If the service lamp is on, run car diagnostics first for troubleshooting. After that, reset the driving mileage or driving time, so as to turn off the service lamp, and enable a new driving cycle.
- If you have changed the engine oil or electric appliances that monitor oil life, you need to reset the service lamp.

3.2 ETS (Throttle Matching)

This function can utilize the car decoder to initialize the throttle actuator so that the learning value of the ECU returns to the initial state. By doing so, the movement of the throttle (or idle motor) can be more accurately controlled, thus adjusting the intake volume.

It needs to be performed in the following cases:

- After replacing the electronic control unit, the relevant characteristics of the throttle operation have not been stored in the electronic control unit.
- After the electric control unit is powered off, the memory of the electric control unit is lost.
- After replacing the throttle assembly, you need to match the throttle.
- After replacing or disassembling the intake port, the controlling of the idle speed by the coordination between the electronic control unit and the throttle body is affected.
- The intake volume and the idle control behavior has changed while staying at the same throttle opening position, although the idle throttle potentiometer behavior hasn't changed.

3.3 SAS (Steering Angle Reset)

This function can reset the steering angle to zero to keep the car running straight.

It needs to be performed generally after replacing the steering angle position sensor, or after replacing the mechanical parts of the steering system (such as steering gear, steering column, tie rod ball head, steering knuckle), or after completing the four-wheel positioning, body repair, etc.

3.4 BMS (Battery Matching)

This function can reset the monitoring unit of the car battery, by clearing the original breakdown information about the lack of battery power to rematch the battery.

It needs to be performed in the following cases:

- Replacement of the main battery needs to utilize battery matching to clear the former information about the lack of power, thus avoiding false information detected by the relevant control module which may cause the failure of some electronic auxiliary functions. For example, the vehicle automatically stops; the sunroof can't work by one key; electric windows can't open and close automatically.
- The battery monitoring sensor uses the battery matching function to re-match the control module with the monitoring sensor, so as to detect the use of the battery power more accurately, and avoid receiving wrong information from instrument prompts which will cause false alarms.

3.5 BLEEDING (ABS Bleeding)

This function enables you to perform tests to check the operating conditions of the Anti-lock Braking System (ABS).

It needs to be performed in the following cases:

- When the ABS lines contain air.
- When the ABS computer, ABS pump, brake master cylinder, brake cylinder, brake line, or brake fluid is replaced.

3.6 BRAKE (Electronic Parking Brake Reset)

This function helps you to replace and reset the brake pads.

It needs to be performed in the following cases:

- The brake pads and brake pad wear sensor are replaced.
- The brake pads indicator lamp is on.
- The brake pads sensor circuit is short, which is recovered.
- The servo motor is replaced.

3.7 DPF (DPF Regeneration)

This function can help remove particulate matter from the trap by using combustion oxidation methods to keep the performance of the trap stable.

It needs to be performed in the following cases:

- Replace the exhaust back pressure sensor.
- Disassembly or replacement of the particle trap.
- Removal or replacement of fuel additive nozzles.
- Removal or replacement of catalytic oxidizer.
- The DPF regeneration fault lamp is lit and matched after maintenance.
- Repair and replace the DPF regeneration control module.

3.8 GEAR (Tooth Learning)

This function can perform tooth learning for the car, to turn off the MIL

It needs to be performed in the following cases:

- After the engine ECU, crankshaft position sensor, or crankshaft flywheel is replaced.
- The DTC "tooth not learned" is present.

3.9 IMMO (Anti-theft Matching)

This function can match the anti-theft key after replacing the ignition key, ignition switch, instrument cluster, engine control unit (ECU), body control module (BCM), and remote control battery.

3.10 INJEC (Injector Coding)

This function can write injector actual code or rewrite code in the ECU to the injector code of the corresponding cylinder, so as to have more accurately control or correct cylinder injection quantity.

It needs to be performed in the following cases:

- After the ECU or injector is replaced.

3.11 TPMS (Tire Pressure Reset)

This function can reset the tire pressure and turn off the tire pressure fault indicator when the car tire pressure fault indicator light is on.

3.12 SUS (Suspension Level Calibration)

This function can adjust the vehicle body height sensor for level calibration after replacing the vehicle height sensor or control module in the air suspension system, or when the vehicle level is not correct.

3.13 AFS (Adaptive Front-lighting System Reset)

This function enables you to initialize the adaptive headlamp system.

3.14 GEAR BOX (A/T Learning)

This function helps complete the gearbox self-learning to improve gear shifting quality.

It needs to be performed in the following cases:

- When the gearbox is disassembled or repaired (after some of the car battery is powered off), which leads to shift delay or impact problem.

3.15 SUN (Sunroof Initialization)

This function enables you to set the sunroof lock off, or closed when it rains; the sliding / tilting sunroof memory function; the temperature threshold outside the car etc.

3.16 EGR (EGR Adaption)

This function can learn the EGR (Exhaust Gas Recirculation) valve after it is cleaned or replaced.

3.17 ODO (ODO Reset)

This function can copy, write, or the value of kilometers in the chip of odometer, so that the odometer shows the actual mileage.

It needs to be performed in the following cases:

- When the mileage is not correct due to the damaged vehicle speed sensor or the odometer failure.

3.18 AIR BAG (Airbag Reset)

This function resets the airbag data to clear the airbag collision fault indicator, so that the airbag computer in the vehicle can run normally.

It needs to be performed in the following cases:

- When the vehicle collides and the airbag deploys, the corresponding fault code of the collision data appears, the airbag indicator lights up, and the fault code cannot be cleared.

3.19 TRANSPORT (Transport Mode)

This function can deactivate the transport mode, so that the vehicle can function normally.

It needs to be performed in the following cases:

- When the following functions disabled including limiting the vehicle speed, not waking up the door opening network, and disabling the remote control key, etc. in order to reduce the power consumption.

3.20 A/F (A/F Reset)

This function can set or learn Air/Fuel ratio parameters.

3.21 STOP/START (Stop/Start Reset)

This function can open or close the automatic start-stop function via setting the hidden function in ECU (provided that the vehicle has a corresponding hidden function supported by hardware).

3.22 NOX (NOx Sensor Reset)

This function can reset the catalytic converter learned value stored in the engine ECU. It needs to be performed in the following cases:

- When the NOx fault is re-initialized and the NOx catalytic converter is replaced.

3.23 ADBLUE (Diesel Engine Exhaust Gas Filter)

After the diesel exhaust treatment fluid (car urea) is replaced or filled up, urea reset operation is required.

3.24 SEATS (Seat Calibration)

This function can match the seats with memory function that are replaced and repaired.

3.25 COOLANT (Coolant Bleeding)

This function can activate the electronic water pump before venting the cooling system.

3.26 TYPE (Tire Reset)

This function can set the size parameters of the modified or replaced tire.

3.27 WINDOWS (Windows Calibration)

This feature can perform door window matching to recover ECU initial memory, and recover the automatic ascending and descending function of power window.

3.28 LANGUAGE (Language Change)

This function can change the system language of the vehicle central control panel.

3.29 AC System Relearn/Initialization

If the ECU or actuator of the vehicle air conditioner is replaced, or the memory of the ECU memory is lost, air conditioner initialization learning is needed.

3.30 Engine Power Balance Monitoring

At the power stroke of each cylinder, power balance monitors crankshaft acceleration, thus determining the relative power provided by each cylinder.

3.31 Gas Particulate Filter Regeneration

After long-term use of the particle catcher, fuel consumption can be increased, engine output power can be decreased, then in this case, the GPF needs to be replaced or regenerated.

3.32 High Voltage Battery Diagnostics

For diagnosis and state information detection on high-voltage accumulator.

3.33 Intelligent Cruise Control System

For replacement of intelligent cruise control system of vehicle and matching after repairing.

3.34 Motor Angle Calibration

There is a deviation between the rotor position detected by the angle position sensor of the motor and the actual rotor magnetic field position, so it is necessary to calibrate the motor angle.

3.35 IMMO PROG (Optional)

Anti-theft editor supports vehicle key chip read and write, EEPROM chip read and write, MCU chip read and write, engine ECU and transmission ECU EEPROM and FLASH read and write.

4. Update

This module allows you to update the diagnostic software & App to the latest version. Tap "Update" on the Home Menu. The following page will appear:

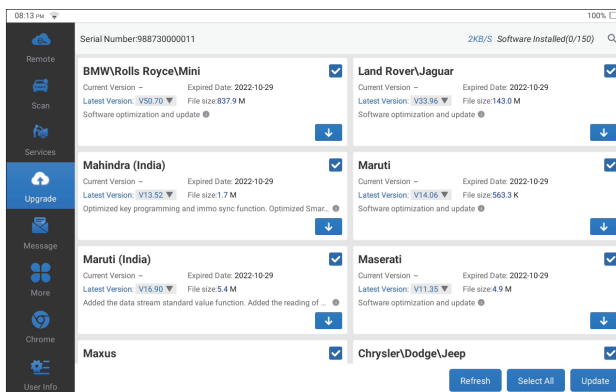

Tap "Update" to upgrade the selected software.

5. Message

To display list of contacted merchants and relevant information.

6. More

Tap "More" on the Home Menu.

6.1 ADAS

Advanced driver assistance systems (ADAS) is an electronic component in vehicles that include a variety of vehicle safety functions such as automatic emergency braking (AEB), lane departure warning (LDW), lane keeping assistance, blind spot elimination, night vision cameras, and self-adaptive lighting. For this function, it is necessary to use the ADAS calibration device produced and activate ADAS software.

Notes: ADAS function requires additional hardware (optional), which needs to be purchased.

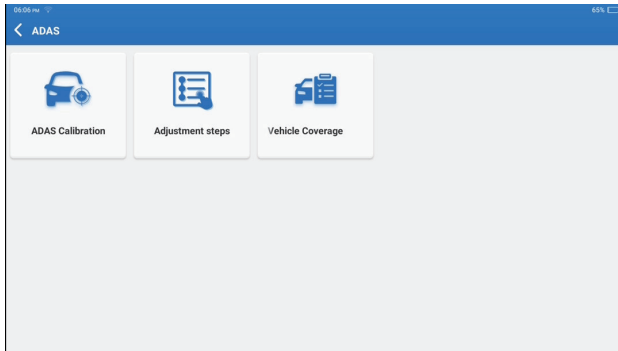

6.2 Battery Tester

Use with the battery detection module, it can detect the battery performance and determine whether the battery needs to be replaced. Regarding the use of the battery detection module, you can click the "Use Guide" in the interface below to view.

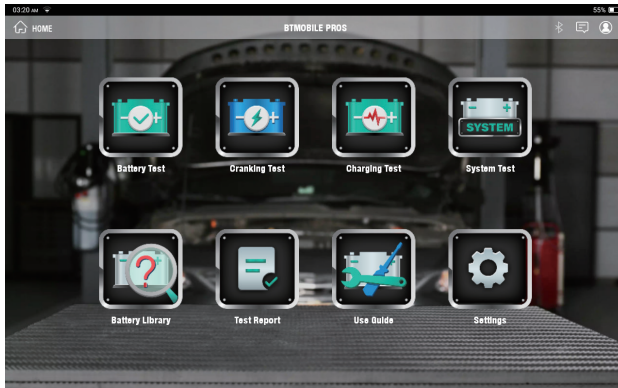

Notes: BATTERY TESTER function requires additional hardware (optional), which needs to be purchased.

6.3 Feedback

You can send the last 20 test records to us by using “Feedback” feature for timely technical assistance if you encounter any unsolved problems in the diagnostic process. Tap “Feedback” on the Home Menu. The following page will appear:

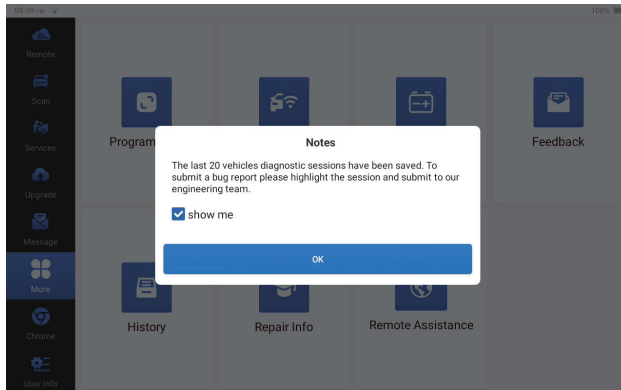

Tap “OK” to enter the vehicle diagnostic feedback selection menu.

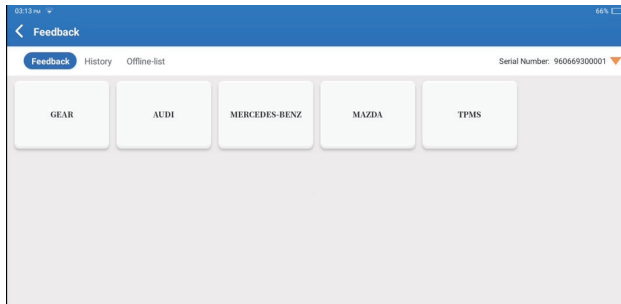

*Explanation of terms:

- Diagnostic Feedback: To show the tested vehicle model list.
- History: To view all diagnostic feedback and check the processes.
- Offline List: To display all diagnostic feedback logs which have not been submitted

successfully yet due to the network failure. The failed logs will be re-uploaded automatically once the tablet gets the stable network signal.

Our technical support will handle your feedback in time for your satisfaction.

6.4 History

This module can record and establish the file of the diagnosed vehicles, including all diagnostic-related data such as diagnostic reports, data stream records, and screenshots.

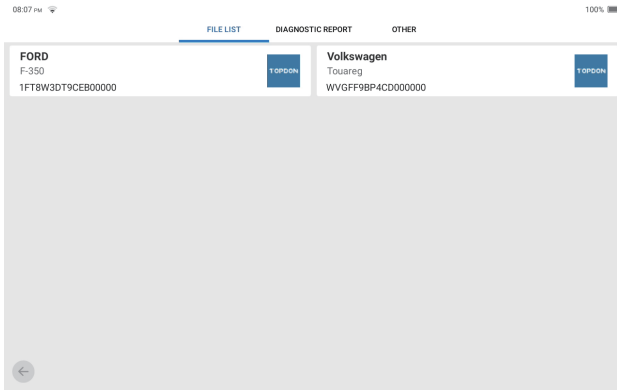

6.5 Repair Info

Tap "Repair Info" on the Home Menu. The following page will appear.

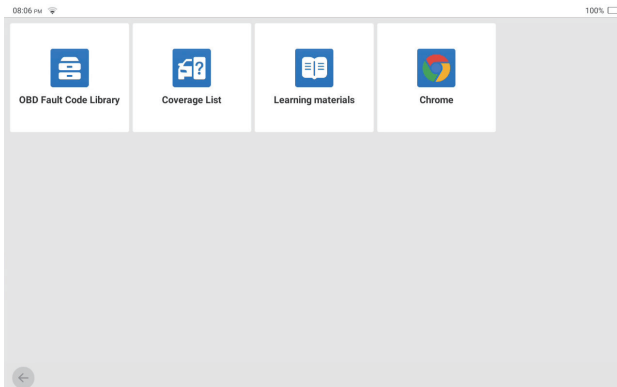

6.6 Remote Assistance

In this function, you can request remote assistance through third-party software [teamview]. By sending your device ID number to the remote technician or after-sales personnel, you can authorize the other party to remotely operate the Phoenix Remote device, so as to guide you to the problems encountered in the process of using the device.

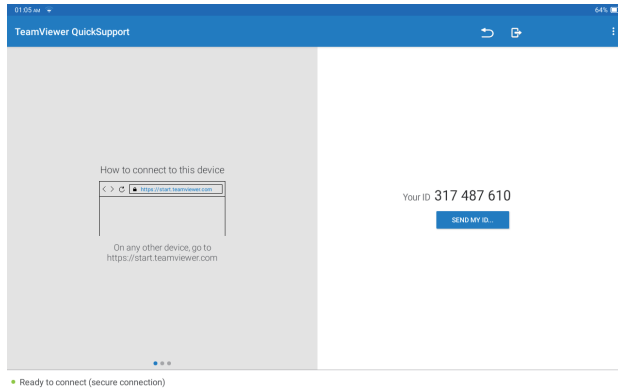

7. Chrome

Tap "Chrome" on the Home Menu. Open chrome browser.

8. User Info

You can modify or add related information in this module, or make settings.

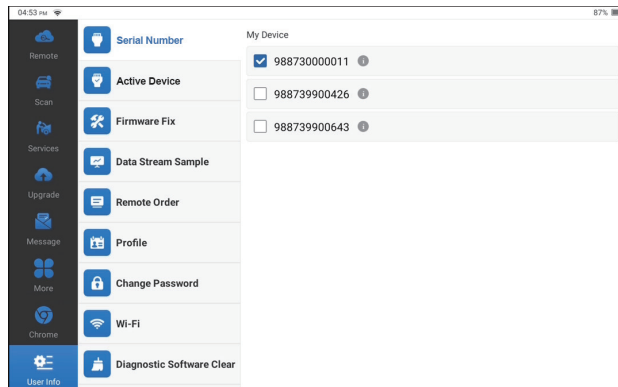

8.3 Firmware Fix

This option can repair the connector firmware. Please don't power off or switch interfaces in the process.

8.4 Data Stream Sample

This option manages the recorded data stream sample files.

8.5 Remote Order

Show user initiated remote diagnostic order.

8.6 Profile

To set and manage personal information.

8.7 Change Password

This option can change the login password.

8.8 Wi-Fi

This option sets up Wi-Fi networks that can be connected.

8.9 Diagnostic Software Clear

This option can clear some cache files and free up the storage space.

8.10 Business Information

This option can add information about the workshop, which will be displayed in the diagnostic report.

8.11 Customer Management

This option manages the information and data of clients.

8.12 Photo Album

This module saves the screenshots.

8.13 Screen Recorder

This module saves the screen recordings.

8.14 Settings

This option makes settings including Units, Language, Time Zone, Clear Cache, USB Connection Mode, Restore Factory Settings, and Log Out.

Technical Specification

Operating System: Android 10.0

Screen: 10" Touchable; 1280 * 800

Memory: 4G

Storage: 128G

Battery Capacity: 12,000mAh/3.8V

Camera: Rear 13.0MP

Network: Wi-Fi, WLAN 802.11b/g/n

Bluetooth: Bluetooth 5.0

Working Temperature: 32°F~122°F (0°C~50°C)

Storage Temperature: -4°F~140°F (-20°C~60°C)

Demission: 11.46*7.83*1.97 inches (291*199*50 mm)

Weight: 62.1 oz(1760.0 g)

Warnings

- ✔ Always perform automotive testing in a safe environment.
- ✔ DO NOT smoke near the vehicle during testing.
- ✔ DO NOT place the diagnostic tool near the engine or exhaust pipe to avoid damage from high temperatures.
- ✔ DO NOT wear loose clothing or jewelry when working on an engine.
- ✔ DO NOT connect or disconnect any test equipment while the ignition is on or the engine is running.
- ✔ DO NOT disassemble the code reader.
- ✔ Engine parts will become hot when the engine is running. To prevent severe burns, avoid contact with hot engine parts.
- ✔ When an engine is running, it produces carbon monoxide, a toxic and poisonous gas. Operate the vehicle ONLY in a well-ventilated area.
- ✔ Wear safety eye protection that meets ANSI standards.

Cautions

- ✔ Please ensure that the vehicle battery is fully charged and the scanner is firmly connected to the vehicle DLC to avoid erroneous data generated by the scanner and diagnostic systems.
- ✔ Please do not use the diagnostic tool during driving.
- ✔ Keep clothing, hair, hands, tools, test equipment, etc. away from all moving or hot engine parts.
- ✔ Keep the scanner dry, clean, free from oil/water, or grease. Use a mild detergent on a clean cloth to clean the outside of the scan tool, when necessary.
- ✔ Keep the scanner out of the reach of children.

FAQ

Q: Can the same type of charger be used to charge the host?

A: No, please charge with the attached charger. The Company is not responsible for any damage or economic loss caused by the use of adapters not provided by TOPDON.

Q: How can the electricity be saved?

A: Turn off the screen when the equipment is not used. The screen standby time shall be shortened. The screen brightness shall be reduced.

Q: Why cannot the host power on after charging?

A:

Possible Cause	Solution
The equipment stands by for a long time, and the battery is under power	Charge for more than 2h first, and then power on the equipment.
Adapter problem	If there is any quality problem, please contact distributors or after-sales service of TOPDON.

Q: Why cannot the product be registered?

A:

Possible Cause	Solution
The equipment is not connected with the network	Make sure that the equipment is connected with the network normally
Notes that your email has been registered	Use another email for register or log in with the username registered by the email (If you forget the username, you can retrieve it by email)
The email didn't receive the verification code during the registration	Check if the email is correct and get the verification code again

Q: Why cannot login?

A:

Possible Cause	Solution
The equipment is not connected with the network	Make sure that the equipment is connected with the network normally
The user name or password is incorrect	Make sure the user name and password input is correct; Contact the TOPDON customer service or regional sales to find back the user name and password
Server problem	The server is maintained, please try later

Q: Why cannot the product be activated?

A:

Possible Cause	Solution
The equipment is not connected with the network	Make sure that the equipment is connected with the network normally
Serial number and activation code input is incorrect	Make sure the serial number and activation code input is correct. (the serial number consists of 12 digits, and the activation code consists of 8 digits)
Activation code is valid	Contact TOPDON after-sales service to get support.
It prompts the setting is omitted	Contact TOPDON after-sales service to get support.

Q: Software upgrading failure.

A:

Possible Cause	Solution
The equipment is not connected with the network	Make sure that the equipment is connected with the network normally
Problems of server	The server is maintained, please try later

Q: The diagnosis line is not powered on when connected to the vehicle.

A:

Possible Cause	Solution
The diagnosis line is insufficient in contact	Please replug the diagnosis line
Vehicle diagnosis seat lines are not in good contact	Please check whether the diagnosis pin is normal
The battery itself of the vehicle is under power	Please replace the accumulator

Q: Can I use other chargers to charge the tablet?

A: No, please use the original charger provided by TOPDON.

Any damage and economic loss caused by using the improper battery charger will not be our responsibility.

Q: How to save the battery power?

A: Please switch off the screen while the tablet is idle, or set a short standby time, or reduce the brightness of the screen.

Q: Are there non-standard OBDII adapters in the box?

A: Yes.

Q: Communication error with vehicle ECU?

A: Please confirm the following cases:

- Whether the ignition switch is ON.

Or, send your vehicle's year, make, model, and VIN data to us via the "Feedback" feature for timely technical assistance.

Q: Failed to get access to the vehicle's ECU system?

A: Please confirm the following cases:

- Whether the system is available in the vehicle.
- Whether the is correctly connected.
- Whether the ignition switch is ON.

Q: Error of the diagnostic software.

A: Please operate as follows:

- Tap "Feedback" to send specific problems to us for technical support.
- Tap the vehicle software icon, and hold it to uninstall the corresponding software, and then enter the upgrade center to download and install the new version.

FCC Statement:

This device complies with Part 15 of the FCC Rules. Operation is subject to the following two conditions:

- 1) This device may not cause harmful interference, and 2) This device must accept any interference received, including interference that may cause undesired operation.