

# Pipe Inspection Camera System

## Operation Manual

**Model No.:BC30MS**



**Model No.:BC35MSLS**

***Please read this Operation Manual carefully before using this Device***

## [ INTRODUCTION]

The pipe inspection system is a powerful set of tools that helps you locate and diagnose problems in a pipeline system. The system is widely used in inspections of Sewer, central air conditioning, chimney, plumbing, building, cable pipe and pipe ventilation systems and other places.

## [GENERAL SAFETY RULES]

### ***Precautions***

Read all safety warnings and instructions. Failure to follow warnings and instructions may result in electric shock, fire and/or serious injury. 1. Save this operation manual for future reference.

2. Do not operate this device in explosive atmospheres, which includes in the presence of flammable liquids, gases, hazardous chemicals, superheated liquid or heavy dust. The device can create sparks which may ignite the dust or fumes.
3. The camera head and the push cable are waterproof (when camera installed on rod cable); however, the keyboard and DVR inside the control box are not. Do not expose them to rain or wet conditions when the control box is open. This will increase the risk of electrical shock.
4. Avoid using the device in environments of extreme cold, heat or humidity as it may damage the device.
5. Do not drop or force the device.
6. Always backup your data before inserting your SD card to this system. The manufacturer is not responsible for any damage or data loss on your SD card for any reason.
7. Do not disconnect the unit while recording or playback. It may damage the unit and/or the SD card.
8. Have your device serviced by a qualified repair person. Service or maintenance performed by unqualified person could result in injury.
9. Do not use where a danger of high voltage contact is present. The device is not designed to provide high voltage protection and isolation.

## [ APPLICATION AND DESCRIPTION OF THE COMPONENTS]

### ***Application***

Suitable for pipes at diameter of 25mm-200mm. Has the ability to go through 90° bends in pipe DN32mm(for 14mm camera with 4.8mm rod) and in pipe DN52mm(for 23mm camera with 6.8mm rod).

### ***Description of The Components***

The pipe inspection system includes four main subassemblies: Camera head, Cable reel, Frame and Toolbox (including DVR, control device, battery, keyboard).

The camera head has high-light white LEDs and a highly scratch-resistant sapphire lens cover; this coupled with stainless steel housing allows the camera to withstand repeated stress in various pipes.

The flexible stainless-steel spring and related components allow the camera through bended pipes. The battery pack also provides power supply for the system and the DVR monitor can record videos and take photos.

The stable and open composite structure is easy to clean.

### ***Camera Head***

1. Sapphire Lens
2. PC lens
3. Stainless Steel Shell
4. Stainless Steel Spring
5. Camera O-ring
6. Gold Connector



Figure 1. Camera Head

### ***Cable Reel***

1. Support Frame
2. Coil Wheel
3. Push Cable
4. Entry Component
5. Wireless Keyboard Receiver
6. Socket (connect to toolbox)
7. Connects Cables
8. Toolbox Holder
9. Coil Fixing Plate
10. Hook
11. Ball Lock Pin
12. Cable Connector (To Camera)
13. Camera Head
14. Cable Stop Housing
15. Camera Holder

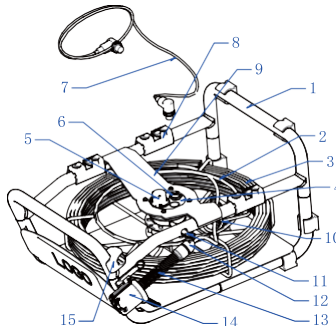

Figure 2. Cable Unit

## **Toolbox Unit**

1. Power Key
2. SD card slot
3. Sunshade
4. High-definition colour LCD display
5. DC input
6. Meter Counter zero-set Key
7. Wireless keyboard
8. Aviation socket
9. Playback mode
10. Menu key
11. Charging and working indicator
12. Image zoom/exit and return
13. Select left/rewind
14. Downward selection
15. Select right/fast forward
16. LED brightness
17. Remote control receiver
18. Start/stop recording
19. Camera Shutter
20. Image rotation
21. Upward selection
22. Enter/Pause
23. Toolbox lock



Figure 3. DVR and Toolbox

## **Remote control**

1. Menu settings
2. Playback mode
3. Reserved function expansion
4. Image zoom/exit and return
5. Upward selection
6. Enter/Pause
7. Select left/rewind
8. Select right/fast forward
9. Downward selection
10. Image rotation
11. LED brightness
12. Start/stop recording
13. Camera shutter

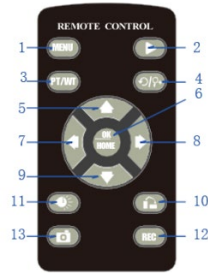

Figure 4. Remote Control

## **Package Contents**

1. Panel with DVR
2. Wireless keyboard
3. Adapter
4. Car changer
5. Remote control
6. 46mm and 80mm skids (for 23mm camera)
7. 28mm skid and Hexagon Spanner (for 14mm camera)
8. Screw, nut and waterproof-ring (for 23mm camera)
9. Hexagon Spanner
10. Screw Driver
11. Operation manual
12. Camera Head
13. Coil Wheel
14. Cable Connector
15. Support Frame

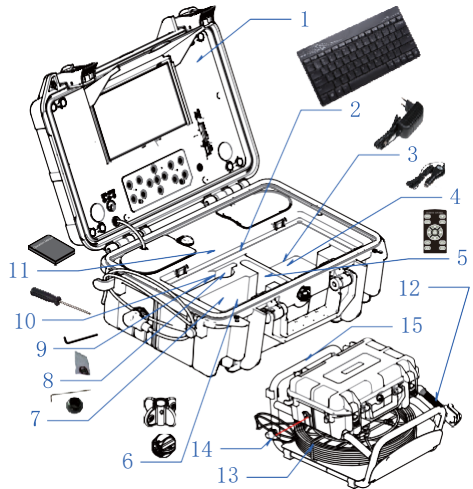

Figure 5. Package Contents

# [ DESCRIPTION SPECIFICATIONS AND STANDARD EQUIPMENT]

## Specifications

	Item	Parameter	
<b>General</b>	Operating Temperature	-10~50°C/+14~+122°F	
	Operating Humidity	30%RH~90%RH	
	Storage Temperature	-20~60°C/+4~+140°F	
	Power Adapter	Input:100-240V AC, Output:12V DC 1500MA	
	Dimension	55×43.5×34.5cm (LxWxH)	
	Weight	11.5-13.0Kg (Approx)	
<b>Camera</b>		<b>Φ23mm camera head</b>	<b>Φ14mm camera head</b>
	Sensor	1/3" CMOS	1/4" CMOS
	TV-Line	420/ 480 TV-Line	400 TV-Line
	View Angle	120°	90°
	Focus Distance	20cm (approx.)	6-8cm (approx.)
	Depth Of Field	100cm (approx.)	20cm (approx.)
	Camera Size	Φ23mm×51mm (Main body)	Φ14mm×21mm (Main body)
	Camera Length	155mm	125mm
	Front Lens	Sapphire	Sapphire
	Shell Material	304# Stainless Steel	304# Stainless Steel
	Lighting	Built-in 15×LED (White)	Built-in 4×LED (White)
	Waterproof	20m water (Camera fix on Cable)	10m water (Camera fix on Cable)
	Power Supply	DC9~15V	DC9~15V
Current Consume	40mA (LED OFF), 95mA (LED ON)	40mA (LED OFF), 60mA (LED ON)	
<b>DVR</b>	Screen	Super bright high-definition color LCD screen	
	Screen Resolution	1024*600	
	Image	Support image rotation	
	Video Resolution	AHD 1080P/ AHD 720P/ CVBS D1	
	Video Encoding	High Compression / H.264	
	Photograph Resolution	1920*1080	
	Audio Recording	Support Local Sound	
	Output	TV Output	
	External Memory	Supports SD Memory Card	
	LED Driver	Built-in Dimmer	
	Playback	Video and Photo	
	Language	English, German, French, Italian, Spanish, Portuguese, Thai, Simplified Chinese, Traditional Chinese, Japanese, Korean, Russian	
	Power Supply	DC 6~12V input	
	Current Consume	700mA Max	
	Battery Capacity	7.4V 5200mAh Li-ion Battery	
Working times per battery charge	About 6 hours		
Charging Time	About 8 hours		
<b>Wireless keyboard</b>	Keyboard Compatibility	Support Specific PC Wireless keyboard	
	Typing Language	English	
	Max Characters	384	
	Hide Characters	Quick One Key hiding	
	Meter Accuracy	Counter ±0.5%	
	Meter and Feet Switch	Support	
	Set Zero	Support	
	Power Consumption	40mA @ 12V DC	
Waterproof	P66m (for connecting ports panel only)		
<b>Cable Wheel</b>	Cable Diameter	Φ4.8mm	Φ6.8mm
	Cable Length	30 meters	35 meters
<b>Tool Box</b>	Dimension	380×260×150mm(L×W×H)	
	Box Color	Black	

## [ INSTALLATION ]

To reduce the risk of serious injury while using the device, please follow the instructions to assemble properly.

### 1. **Install Cable Reel (Figure 6.)**

Put the cable reel into the frame from the right side, place it in the right direction and then tighten the screw and nut. Pull out the cable with care, thread it through the hook and lead the cable out.

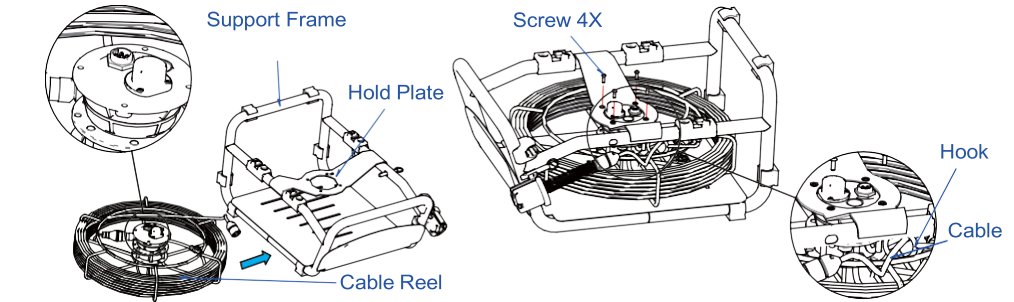

Figure 6. Install Cable Reel

### 2. **Install Toolbox Unit (Figure 7.)**

- Step 1. Plug one end of the spring cable into the aviation socket on cable wheel according to the direction of long straight cable and tighten the screw.
- Step 2. Clip the toolbox holder into the fixed seat on the frame, and push it to the position.
- Step 3. Thread the ball lock pin through the toolbox holder and the frame.
- Step 4. Connect the other end of the spring cable with the aviation socket of the toolbox and tighten the screw (direction of long spring cable).

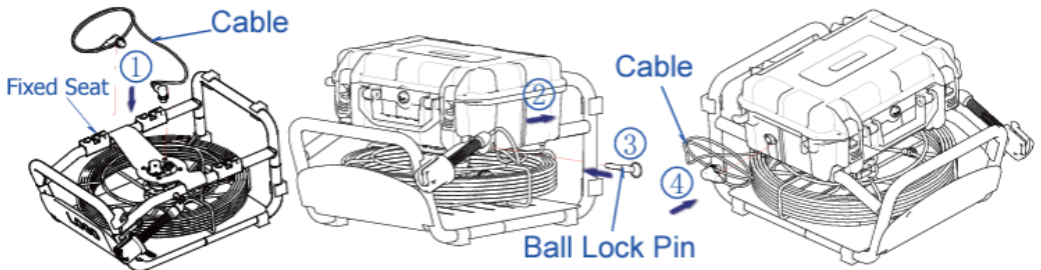

Figure 7. Install Toolbox Unit

### 3. **Install Camera Head (Figure 8.)**

Hold the cable connector and screw the camera into the cable connector tightly.

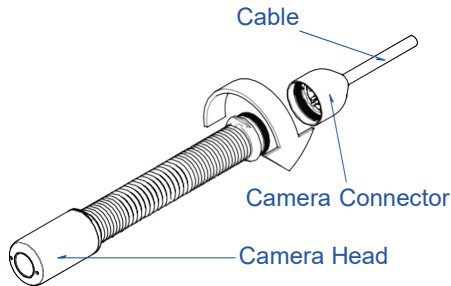

Figure 8. Install Camera Head

#### **4. Install support guides**

Support guides are used to keep the camera head in the center of different sized pipes and to keep camera head away from mud at the bottom of pipes, to keep camera head clean and have best quality images.

##### **4.1. 23mm camera head**

###### **a. Install 46mm support guide. (Figure 9.)**

Mount the 46mm support guide onto the stainless-steel camera head. Tighten the screws with screwdriver.

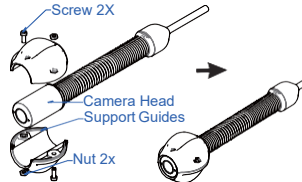

Figure 9. Install 46mm Support Guide

###### **b. Install 80mm support guide. (Figure 10.)**

Mount the 80mm support guide onto the stainless-steel camera head. Tighten the screws with screwdriver.

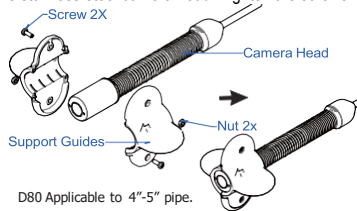

Figure 10. Install 80mm Support Guide

##### **4.2. 14mm camera head**

###### **Install 28mm support guide. (Figure 11.)**

Mount the 28mm support guide onto the stainless-steel camera head. Tighten the screws with Wrench.

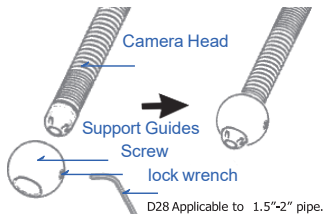

Figure 11. Install 28mm Support Guide

#### **5. Install SD card (Figure 12.)**

The SD card (16GB Only) needs to be inserted into the DVR card slot.



#### **6. Turn on the DVR.**

# [ FUNCTION GUIDE AND OPERATING INSTRUCTIONS ]

## DVR icon introduction

1. LED brightness
2. Meter counter display (meters)
3. Meter counter display (feet)
4. Record indication
5. Time indication
6. Date indication
7. Sound recording indication
8. SD card
9. Battery level indicator



Figure 13. Screen icon

## [DVR Operation]

### **1. Insert SD card**

Please insert the SD card before using the device. (Note: To ensure the device will operate normally, please use a Class10 high-speed branded SD card. Please format the SD card if using it on device for the first time)

### **2. Turn On/Off**

Press the [  ] key to turn on/off. It will enter the Live mode automatically.

### **3. Function Buttons**

Light adjustment: In the live mode, press the [  ] to decrease or increase the brightness of the LEDs

Image rotation: In Live mode, press the [  ] to rotate image.

Camera Shutter: In the Live mode, press the photo [  ] to take a photo, and the photo will be saved in the folder of the SD card.

Record a Video: In Live mode, press the [ **REC** ] to start /stop recording a video, and the video file will be saved in the video folder of the SD card.











Menu setting: In Live mode, press the [  ] to enter the menu setting.



Image magnification: In Live mode, press the [  ] to magnify image.

Exit/Return: During parameter setting and file management, press [  ] to exit or return.

### **4. Parameter Settings**

Under Live mode, press [  ] to enter the parameter setting; press [  ] and [  ] to select the menu you need to change,

press [  ] and [  ] to select the submenu that you need to change, and press [  ] to confirm the submenu, press [  ] and [  ]

to select the value , press [  ] to confirm and save the settings; press [  ] to exit the setting.

#### **4.1 Recording settings**

Video size: To set the resolution of the recorded video files.

Loop recording: 5min/10min/30min, the recorded files are divided according to the set size, and the system will automatically prompt on screen when the card is full.

Encoding type: To set video compression format to the requirements. Sound switch: you can turn on or off the recording sound. Exposure setting: The sensitivity of photo and video shooting can be set according to the brightness of the environment to improve the image quality.

#### **4.2 Display settings:**

Screen brightness: You can set the display brightness of the screen.

#### **4.3 System settings:**

Format: The capacity of the SD card can be displayed, and the user can format the SD card.

Language settings: English, Simplified Chinese, Traditional Chinese, Japanese, Korean, Russian, German, French, Italian, Spanish, Portuguese, Thai

Light source frequency: Different light source frequencies can be set according to the requirements.

Volume: To set the volume of the recorded sound.

Date and time: To adjust date and time.

Time zone selection: To choose the time zone of your area.





Restore factory setting: The factory setting can be restored.

Device information: System version information.

## **5. File Management**







In the Live mode, press the [  ] key to enter the folder. The user can browse, play or delete recorded videos or photos.

Browse files: After entering the folder, press the [  ] and [  ] keys to browse the media files.

Playback files: After entering the folder, press the [  ] and [  ] keys to select the media file, press the [  ] key to play or pause the play. When playing a video or photo, press the [  ] key to play the previous file, press [  ] Key to play the next file.

Fast forward and fast rewind: When playing a video, press the [  ] key to fast forward playback, press the [  ] key to fast reverse playback, and press the [  ] key to pause playback.

Delete Files:

- a. Entering the folder, press the [  ] and [  ] keys to select the media file to be deleted. Press the [  ] key to enter the delete mode, press the [  ] and [  ] keys to select whether to delete the media file, and press the [  ] key to delete or cancel the deletion of the media file.
- b. When playback a file, you can also delete or cancel the deletion of media files with the above steps.

## **[ WIRELESS KEYBOARD OPERATION ]**

The keyboard is used for typing Characters with the wireless keyboard which displays on screen. The Character can be displayed in recorded video or captured imagine. It supports max. 384 characters and quick one key hiding Characters.

### **Text Input**

1. Type characters with wireless keyboard. Use Arrow key to move cursor, Backspace key to delete, and Enter key to change a new line.
2. Esc key to hide or appear all characters. Ctrl + Del to delete all characters.
3. You can type and edit characters while recording. The typing and editing will be recorded in the video files.
4. The typed characters will be stored in memory.

### **Backstage Operation**

You can press "F1" or "F2" key within 5 seconds after DVR monitor starts to enter F1 or F2 backstage operation.

1. The first line is reserved for user to type company name, operator name, phone number etc., and these contents won't be hidden by pushing ESC button. You can edit the contents by using F1 key, and press Enter key to save and exit.
2. Please refer to meter counter operation prior to this operation. Using F2 background key to select the unit of length or the total length of push cable (this is designed if the length of push cable changed). When the "L=" flashes, press up or down arrow key to select the unit of length, or select the correct total length. Press enter key to save and exit.

## **[ METER COUNTER OPERATION ]**

1. Press the meter-zero button to set the meter to zero on screen display.
2. Change the unit of length or the total length of push cable, please refer to 'F2 backstage operation' section in the wireless keyboard operations.

**Note1: The deviation of MC will increase if the total length is not correct. You need to select the correct total length to decrease the deviation. Use this function to change the displayed total length when the push cable is cut off for more than 3 meters.**

**Note 2: Turn on the system before pulling out the push cable from the cable reel. It can decrease the deviation of the MC.**



## [ PUSH CABLE AND CAMERA OPERATION]

### At the job site

1. Always wear rubber gloves to operate the camera for health and safety requirements. Positioning the cable reel properly will save time and pushing it out and in to the pipe with strength will reduce equipment damage rate.
  - When pushing the cable, you should stand near the pipe entry. Standing too far away as well as having too much excess cable may cause the cable to fold and get damaged.
  - Try to keep the push cable away from sharp edge of a pipe entry because this may cause damage. If the camera does not seem to go any further, **DO NOT FORCEFULLY PUSH THE CAMERA!** Try another entry if possible.

**NOTE! Hands should be close to the pipe line opening. DO NOT hold the cable at the edge of an entry to push.**

2. Always try to keep water running down the pipe while inspecting. This will keep the system much cleaner, and allow you to push further with less friction. If you can't see an area clearly, please turn the water off temporarily.
3. Please keep hands at the entrance to control the push cable to prevent it stuck, bent or scratched by pushing it steadily and slowly, short distance every time to the pipeline.
4. When inspecting a pipe, a slow steady push through the system works the best most of the time. When changing directions such as P-traps, Tee's, Y's, Elbows, etc. it is necessary to give a little extra push in the bends. The area to the camera head approximately 8" (20cm) from the bend, give it a quick push if necessary, "popping" the camera through a turn, the least amount of force required. Try to be as gentle as possible, and do not hammer or snap the camera head through corners. After practice, you will learn that the best way to inspect a section of pipe is to push the camera through quickly then draw the camera back slowly and evenly.
5. Make sure the sapphire Lens is clean prior to entry. Some users advise that a slight film of detergent on the lens reduce the possibility of grease sticking to the port. Take advantage of jiggling it in the water of the pipe to wash the camera if necessary.
6. When you place the camera head into the pipe, as the pipe materials may vary, it will be necessary to adjust the lighting settings to maximize image quality.
7. The system can travel through multiple 45 and 90 degree bends and wyes. However, DO NOT try to force it through a P-trap or T if there is a large amount of resistance.

**NOTE! Do not try to use the camera head to clear obstructions. This System is a diagnostic tool, not a drain cleaner. Using the camera head to clear obstructions could damage the camera head or cause it to be caught in the obstruction.**

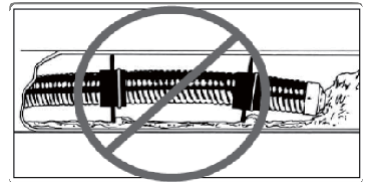

Figure 14 Improper operation

8. Do not attempt to remove or store push cable on the reel by turning the reel only. You can manually push or pull cable from the reel and wind or unwind it.
9. If the camera sits in a pipe, or an enclosed environment, heat will build-up. This may lead to the camera head overheating which will show fuzzy cool lines on the monitor. If this happens, turn off the system, remove the camera from the pipe (or enclosed environment) and let the camera head cool for 10 to 15 minutes. Running water into the line will also help cool the camera head. Always use the minimum illumination to maximize image quality and to avoid excessive heat build-up.

**NOTE! The camera head can get HOT! When finishing inspection, or if taking a prolonged break in the middle of the inspection, turn off the system.**

### Retrieving the push cable

1. Once the inspection completed, pull the push cable back with slow, steady force. To avoid damage to the camera or push cable, do not exert excessive force during retrieval. The push cable may get hung up after retrieved, and may need to be stored as insertion.
2. When taking back the push cable, it can be flushed down by running water. You can wipe the push cable with a towel after.

**Note! NEVER USE SOLVENTS to clean any part of the system. Substances like acetone and other harsh chemicals can cause cracking of the camera ring, which could affect waterproofing.**

3. Storing the push cable into the cable reel. One hand holds the push cable, the other hand close to the cable wheel. Slowly and gently push the push cable slide via the hook on the handle, cable reel will rotate and store the push cable inside.

**Note! The hands should be close to the cable wheel when storing the push cable. Push the push cable a short distance every time. Push a long distance can cause the push cable to bend or break.**

## [BATTERY SAFETY AND GUIDES]

### **Battery safety**

Read the following battery precautions before charging to reduce the risk of electrical shock.

1. Recharge batteries with accessory charging units.
2. Check the power units every time before using the equipment. Using unauthorized parts may cause electrical shock, fire and/or serious personal injury or damage to other equipment and system.
3. Never connect the car charger to any 24 volts cigarette lighter slot. This will damage the battery and DVR.
4. Do not short circuit, it may cause fire, electrical shock.
5. Do not charge the battery under rain or wet conditions. Water entering the charger will increase the risk of electrical shock.
6. If the charger and battery are damaged, do not use or stop to charge. It may cause electrical shock.
7. Don't disassemble the case. Only qualified repair person can repair and maintenance.
8. Dispose the battery properly. Exposure to high temperatures can cause the battery exploded. Do not dispose in a fire. Some countries have regulations of battery disposal. Please follow all applicable regulations.
9. Do not touch anything leaking out from battery, which would burn or damage the skin. If touch, please flush with water. If contact eyes, please seek medical assistance immediately.

### **Guides**

Follow the steps as below to reduce the injury of the electric shock.

1. Power indicator LED will be red at charging, will turn to green when fully charged. If battery is flat for a long period, it will pre-charge the battery automatically for 10 minutes, and LED will be blinking in red.
2. It takes about 8 hours to get battery fully charged. The battery can be charged by wire. It will not influence the charging time if charging and operating at the same time.
3. User can charge the battery by a power adaptor or car charger. If not intended to use for a long time, recharge it every 6 months to ensure the battery in normal working condition.

## [ OTHERS ]

### **Troubleshooting**

<b>Problem</b>	<b>Probable fault location</b>	<b>Solution</b>
No image	Cable connection faulty or loose	Check cable connection. Clean and reconnect if necessary
	Camera connector soiled	Clean the camera connector
	Wrong SD memory card	Turn off power and replace SD card
	Wrong setting	Press the setup menu and select reset
DVR not boot	No power	Recharge
	Transient short circuit in the cable cause the battery short circuit protection	Recharge the DVR more than 2 seconds with adaptor or car charger to activate the battery
Cannot input Characters	The wireless keyboard low battery	Change battery
	Wireless Keyboard or Receiver faulty	Check the Keyboard Receiver and the keyboard on a PC
The deviation of MC more than 0.5%	Select the wrong total length	Re-select the correct total length. You can press F2 key when the machine boot within 5 sec to enter background to select
	Pull out cable more than 3 meters before turning on the system	Turn on the system before pulling out the push cable from the cable reel
DVR charging indicator lights up green and cannot be charged	The battery temperature exceeds the range of -5~+48°C	Put the product under normal temperature for 30 minutes to resume charging automatically
When charging, the yellow and green charging indicator lights are not on	Power adapter failure	Replace a power adapter

### **FCC Statement**

This device complies with part 15 of the FCC Rules. Operation is subject to the following two conditions:

1. This device may not cause harmful interference.
2. This device must accept any interference received, including interference that may cause unexpected operation. Any changes or modification not expressly approved by the party responsible for compliance could void the user's authority to operate the device.

### **CE**

This product complies with standards including Low Voltage Device Directive 73/23/EEC;

### **EMC**

Directive 89/336/EEC. It passed the subject tests by the authority concerned and is authorized to bear CE mark.

**Camera BC23MMSLS :23mm camera with both self-leveling and 512Hz Sonde**











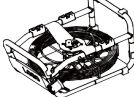

**For 6.8mm rod cable**

Type	Item	Parameter
Image	Sensor	CMOS
	TV-Line	420 TV-Line
	Resolution	720×576
	View Angle	120°
	Focus Distance	20cm (approx.)
	Depth-of-Field	100cm (approx.)
	Front Lens	Sapphire
Transmitter	Frequency	512Hz
	Transmit Mode	Constant
	Transmission Distance	6 meters open area (max)



Figure 17. Camera BC23MMSLS

## ***Part Number List***

No.	Part Number	Part Name	Specifications	Picture
1	BC23MMSLS	23mm camera head	CMOS 420TVL, $\Phi 23 \times 155$ mm, 120° View Angle with Self Leveling, with 512Hz Transmitter	
2	BC14MMS	14mm camera head	CMOS 400TVL, $\Phi 14 \times 125$ mm, 90° View Angle with 512Hz Transmitter	
3	BCBG2380	Guide	80mm Support Guide	
4	BCBG2346	Guide	46mm Support Guide	
5	BCBG1428	Guide	28mm Support Guide	
6	BCFK48-14	Cable wheel and frame For 14mm Camera Head	Include frame, coil, cable, push rod and keyboard text writer unit components Cable length: 30m	
7	BCFK68-23	Cable wheel and frame For 23mm Camera Head	Include frame, coil, cable, push rod and keyboard text writer unit components Cable length: 35m	
8	BCKB2	Wireless keyboard	Wireless keyboard and receiver	
9	BCCABLE	Cable	6-6 pin spring type connection cable (plugs at 90° shape)	
10	BCADAPTOR	Adaptor	DC12V 1.5A Adaptor	
11	BCRK68-23	Repair accessories	Cable front end maintenance accessories (For 6.8mm fiberglass cable)	
12	BCRK48-14	Repair accessories	Cable front end maintenance accessories (For 4.8mm fiberglass cable)	
13	BCBOX	Control Box	Control box	
14	BCPANEL	Panel	Panel	
15	BCBATT	Battery Pack	Battery	