

Installation Guide



PLEASE NOTE:

Before you begin, read the instructions below and observe all local plumbing and building codes.

Unpack and inspect faucet for any shipping damages and ensure that none of the required pieces are missing. If you find any damages, do not install. Contact Customer Service at 213-425-3095.

We recommend consulting a professional if you are unfamiliar with installing bathroom fixtures and plumbing. Eisen Home accepts no liability for any damages to the floor, walls, plumbing or personal injury during installation.

Care should be exercised when cleaning this product. Although its finish is extremely durable, it can be damaged by harsh abrasives and cleaning pads. Use a light, non-abrasive cleaning solution or cleaning polish to clean the faucet surface.

If any questions or concerns arise, please feel free to reach out to us



cs@eisenhome.com



eisenhome.com



(213) 425 3095

We recommend consulting a professional if you are unfamiliar with installing bathroom fixtures and plumbing. Eisen Home accepts no liability for any damages to the floor, walls, plumbing or personal injury during installation.

RECOMMENDED TOOLS

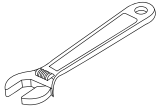

Adjustable wrench

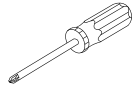

Philips screwdriver



Pipa tape

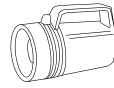

Flashlight



Hex key

DIAGRAM & PARTS LIST

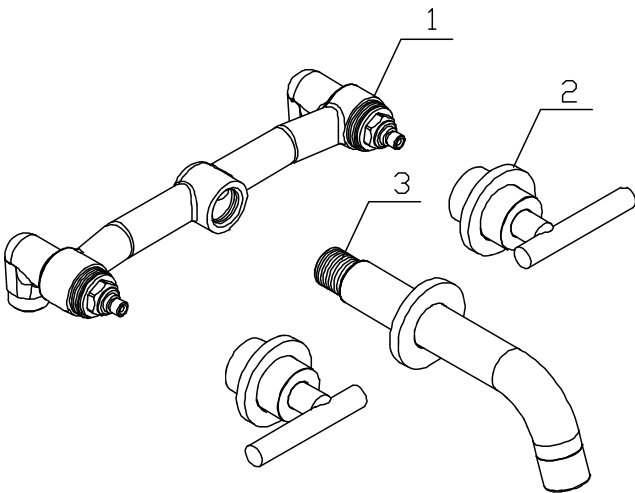

1. Body
2. Handle
3. Spout

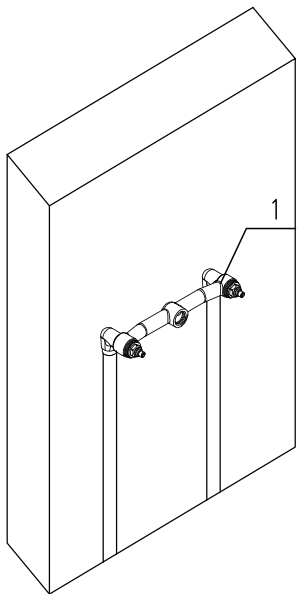
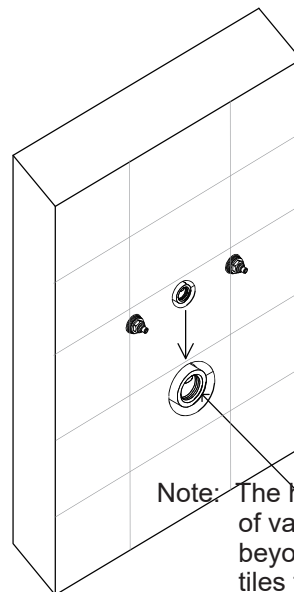
STEP 1**STEP 2**

Note: The horizontal plane of valve doesn't go beyond the tile after tiles fixed.

1. Connect hot and cold supply hoses. Open the angle valve and test the hoses if leaking. Close the cartridge and continue testing for leaks for about 3 minutes.
2. Install Tiles if required.

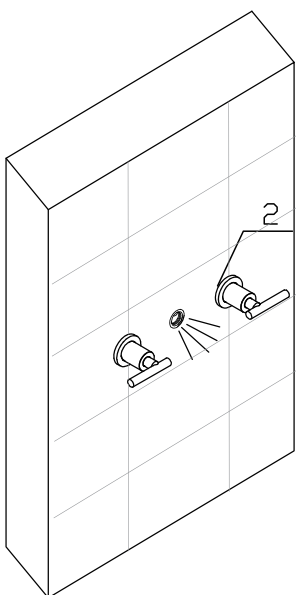
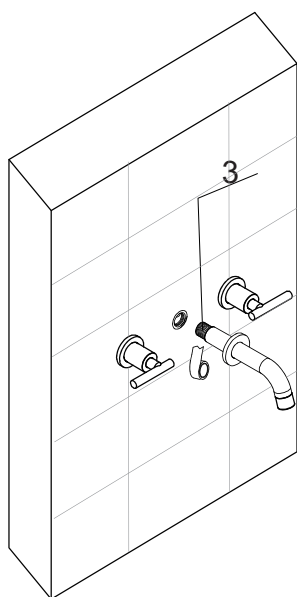
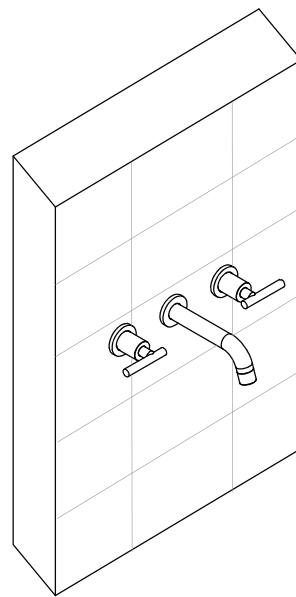
STEP 3**STEP 4****STEP 5**

3. Install the two handles and open the cartridge.
4. Wrap the tape around the spout and then install it.
5. Installation should be complete.

MAINTENANCE & CARE INSTRUCTIONS

Care should be exercised when cleaning this product. Although its finish is extremely durable, it can be damaged by harsh abrasives and cleaning pads. Use a light, non-abrasive cleaning solution or cleaning polish to clean the faucet surface.



Micro fiber cloth/towel



Soapy water



PH balanced soap based cleanser



Any Chemical free cleanser



Cleaner with wax or filling agents



Cleaners with unidentified chemicals



Anything that can scratch the surface



Caustic, acidic or abrasive agents with any solvent

This warranty extends only to the original owner/end-user for personal household use only. For commercial uses, additional limitations may apply. Eisen Home warrants mirrors, bathtubs, faucet finishes and fittings to be free from defects in workmanship and materials under normal use and service for a period of two (2) years. Eisen Home will, at its election, repair, replace, or make appropriate adjustment where Eisen Home optional inspection discloses any such defects occurring in normal usage within the warranty periods. Please note that Eisen Home is not responsible for installation or removal costs. Improper modification of any bathtub and/or faucet may void the warranty.

This warranty does not cover any claim arising from abuse, misuse, negligence, accident, improper installation or operations on the part of the purchaser. This warranty is void if the Eisen Home product is subject to alterations, or if repairs are attempted by anyone other than an authorized agent of Eisen Home. This warranty does not extend to any plumbing or components installed by dealers, installers or by any party other than Eisen Home. Implied warranties, including that of merchant ability or fitness for a particular purpose, are expressly limited in duration to the duration of this warranty. Eisen Home disclaims any liability for special, incidental or consequential damages.

PRODUCT LIMITATION OF LIABILITY

Eisen Home shall not, under any circumstances, be liable for special or consequent damages, such as, but not limited to,

1. Damage to or loss of other property or equipment,
2. Loss of profits, revenue or reputation,
3. Cost of replacement goods,
4. Cost of storage, handling and/or care of damaged, defective or nonconforming goods or
5. Claims of buyer's customer or service interruptions.

Eisen Home is not responsible for any additional parts or equipment required for the installation or use of any of its products or merchandise, such as plumbing supply requirements (elbow joints, valves, pipes etcetera). Eisen Home is not responsible for the installation of any of its products or merchandise.

The liability of Eisen Home arising out of or related in any way to the sale, delivery, resale, installation or use of the goods sold by or furnished by Eisen Home, whether arising out of contract, negligence, strict tort, or any warranty or otherwise, shall not exceed the price of the specific goods upon which liability is to be based. Buyer's remedies for any breach of this agreement by Eisen Home, or with respect to Eisen Home liability under this agreement shall be limited to either Eisen Home choice of any of the following:

1. The repair of the goods,
2. The replacement of the goods,
3. The return of the goods in question to Eisen Home and the return to the buyer of any consideration paid to Eisen Home for said goods.

Register your product at: www.eisenhome.com/warranty-terms



cs@eisenhome.com



eisenhome.com



(213) 425 3095