

FEATURES

- Slim Rectangular Overflow with Polished Chrome Finish
- Non-Porous, Easy to Clean Surface
- High Heat Retention
- UPC Approved

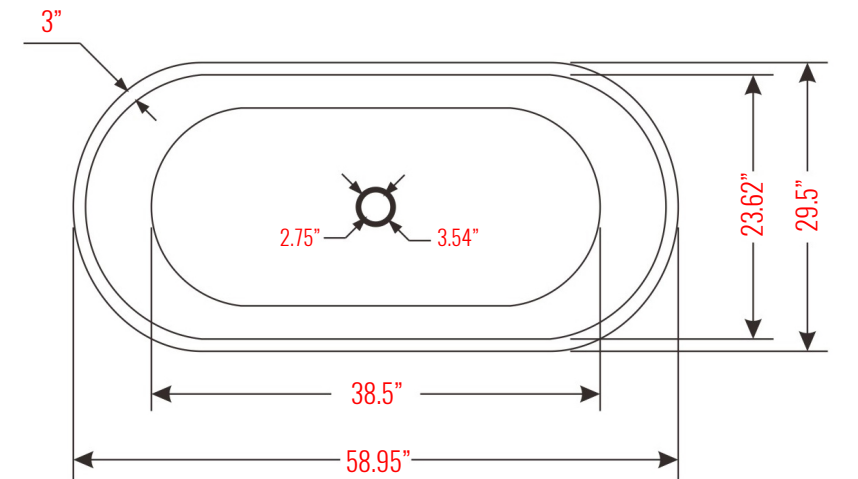

Unit	Length	Width	Height
inches	58.95"	29.4"	23.62"
mm	1497.33	746.76	599.94

