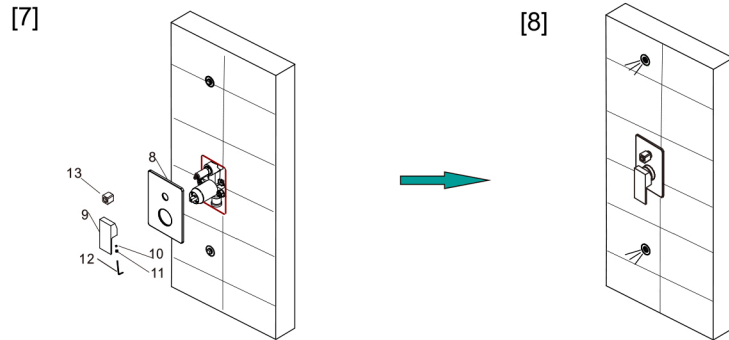


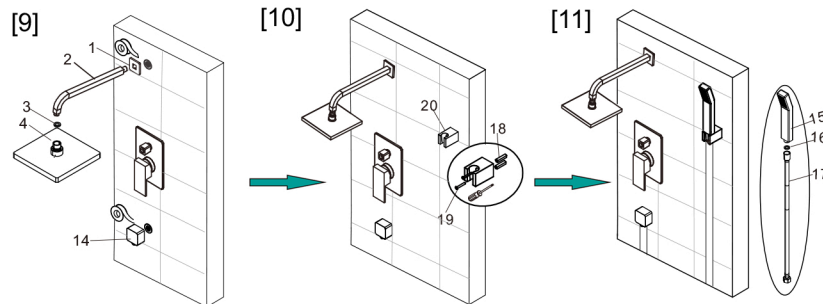
SINGLE HANDLE PRESSURE BALANCE BATH FAUCETS

ASSEMBLY INSTRUCTIONS



7. Feed the valve body with panel(8) ,handle(9) and diverter(13), then use the allen key(12) and screw(10) to secure handle(9) and diverter(13), put on the red/ blue button(11).

8. Take off hand shower, up and down plugs, turn on the cartridge to wash out the dirt in the water tube.

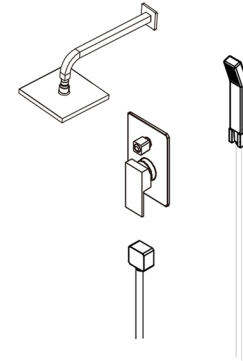


9. Use the tape to install in turn, trim(1),shower arm (2) and elbow(14).Then install the shower head(4) with the gasket(3).

10. Install the base (20).
(Insert 2pcs setscrew(18) ,fix it by the screw(19).)

11. Connect the Flexible hose(17),Gasket(16) and hand shower (15). Testing for leakage after installation. Complete installation.

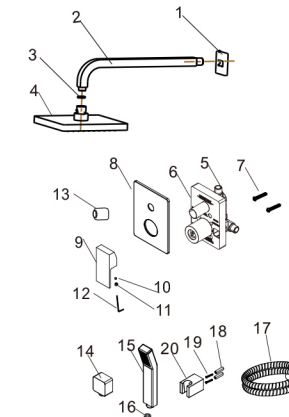
SINGLE HANDLE PRESSURE BALANCE BATH FAUCETS



Solid Brass Construction
Pressure Balance Valve/Gear Type
Easy Installation

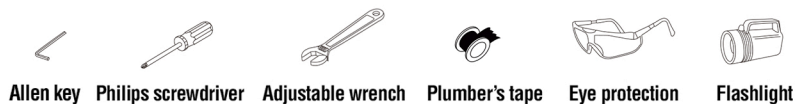


DIAGRAM & PARTS LIST



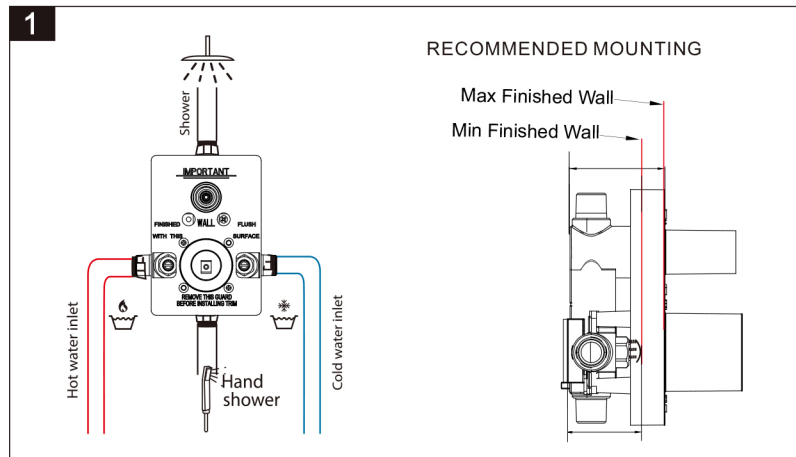
- | | |
|-----------------------|-------------------|
| 1. Trim | 12. Allen key |
| 2. Shower arm | 13. Diverter |
| 3. Gasket | 14. Elbow |
| 4. Shower head | 15. Hand shower |
| 5. Valve body | 16. Gasket |
| 6. Cover plate | 17. Flexible hose |
| 7. Tapping screw | 18. Set screw |
| 8. Panel | 19. Tapping screw |
| 9. Handle | 20. Base |
| 10. Screw | |
| 11. Red / Blue button | |

RECOMMENDED TOOLS

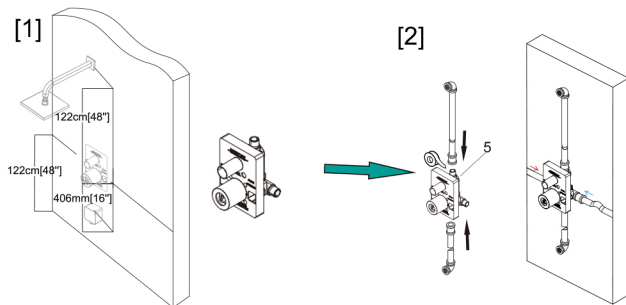


SINGLE HANDLE PRESSURE BALANCE BATH FAUCETS

APPLY STYLES



ASSEMBLY INSTRUCTIONS

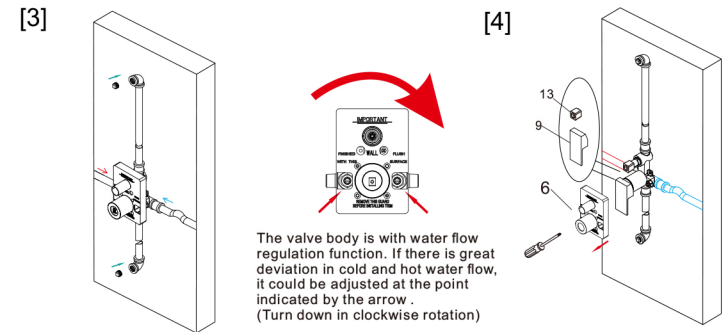


1. Installation reference size as pic .

2. Connect the pipes into the valve body(5) ; Put valve body(5) against the wall . Then connect the water supply hoses .

SINGLE HANDLE PRESSURE BALANCE BATH FAUCETS

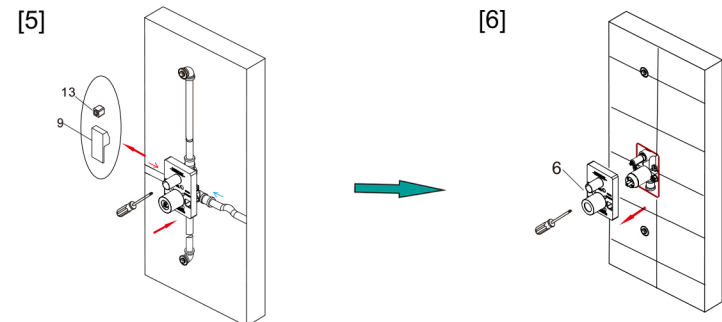
ASSEMBLY INSTRUCTIONS



3. Plug the water outlets after the valve body is installed.

4. Remove the black cover plate(6). Install the handle(9) and diverter(13). Provide water from water inlet.

- Then test if the water pipes are leaking or not as below:
 1) Test 3 min @ 1.6 Mpa when the ceramic cartridge is closed
 2) Test 3 min @ 0.4 Mpa when the ceramic cartridge is open
 Proceed to the next step if there is no leakage after the testing.



5. If the water test is succesful, remove handle (9) and diverter (13), and put on cover plate (6).

6. Backfill the wall in concrete, tile on concrete and then remove the black cover plate(6)when available.