



TEMPUS-AG-4G Base Station

4G-LoRa™ Gateway



TEMPUS-AG-4G Base Station

4G-LoRa™ Gateway



PRESENTATION

TEMPUS-AG-4G is a 4G-LoRa™ gateway that allows data transmission between the MyToroTempus application or platform and TEMPUS-AG devices (CT, MS, PR, MV). TEMPUS-AG-4G connects to the MyToroTempus, application or web platform, via Internet in 4G. TEMPUS-AG-4G can communicate via LoRa™ (long range radio connection) with up to 25 devices between TEMPUS-AG-CT/MV/MS/PR. TEMPUS-AG-4G can be powered by a 230VAC power supply or a solar panel. It has a buffer battery to ensure the continuity of its operation for 24 hours without any power supply (depending on the conditions of use).

INTRODUCTION

The frequency of 4G data communication:

Thanks to its SIM card, the TEMPUS-AG-4G communicates periodically over 4G with the MyToroTempus platform in order to:

- Transmit the informations to TEMPUS-AG-CT, TEMPUS-AG-MV.
(e.g.: irrigation programs, manual controls, ON / OFF, etc ...)
- Feed back information from TEMPUS-AG-MS, TEMPUS-AG-PR
(e.g.: battery level, water volumes, sensor alerts, etc.)

The frequency is 24 times per day. Communications are configured every hour.

To activate your SIM card, visit toro-ag.it/sim

Once the SIM card has been activated, the TEMPUS-AG-4G will be operational and will be able to connect to the MyToroTempusAG platform.

RECOMMENDATION

During the first installation or if a long time has passed without having had a charge / discharge cycle, it is necessary to charge the TEMPUS-AG-4G battery, turned off, for 24 hours with 230 VAC power supply.

Follow the step 1 to wire the 230 VAC power supply for battery charging.

The disposal of a lithium battery in a fire or in a hot oven, or mechanical crushing or battery cutting, is likely to cause an explosion;

If the battery is kept in a very high temperature environment, it may cause an explosion or a liquid or flammables gas leakage; If a battery is subject to an extremely low air pressure, it may cause an explosion or a liquid or flammables gas leakage.

In case of a battery replacement, only use a SAFT MP174565 xtd battery.

SPECIFICATION

Dimensions

Diameter: 115mm

Height: 307mm

Used frequency band:

Bluetooth®: [2400-2483.5]M hz

LoRa™ [902-928]Mhz

4G: [2100]Mhz

Power Supply:

Power pack: INPUT: 100-240V 50/60Hz (supplied)

OUTPUT: 24VDC 0.6A

Solar panel : 12V 20W (in option)

Battery : 4V 2.5Ah

IP 54

Use:

Permitted humidity: 90% (relative humidity)

Ambient temperature: -20°C to 60°C

Warranty: 2 years

Step 1

INSTALLATION

TEMPUS-AG-4G ELECTRICAL WIRING

Regardless of the power supply or solar panel, the wiring is the same. The connection of the power cable is made by a 2-core cable for which there is no polarity.

- Remove the upper and lower part of the TEMPUS-AG-4G by rotating them.
- Insert the SIM card (If not already inserted)

During the first installation it is necessary to charge the TEMPUS-AG-4G, turned off, for 24 hours with 230 VAC power supply.



1.1 Power supply

- Drill the grommet located under the lower part of the TEMPUS-AG-4G
- Pass the cable through the grommet.

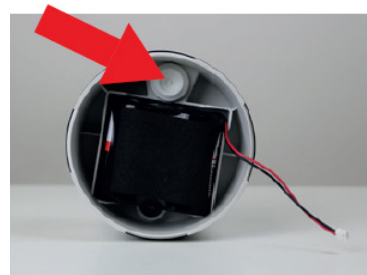

- Connect the cable to the green connector. (No polarity to respect)



Power transformer connection and recommendations

IMPORTANT SAFETY INSTRUCTIONS:

This product must be installed in accordance with the applicable installation code and local jurisdiction by a person familiar with the construction, installation and operation of the product and the hazards involved.

The use of or installation of junction boxes, conduit bodies, conduit connections, and fittings shall be for the installation and intended use, and in accordance with applicable electrical code. consult with a qualified electrician and local electrical codes before installing any electrical product.

Disconnect all power before servicing. ensure main ac breaker is off. Failure to comply may result in serious injury due to electrical shock hazard.

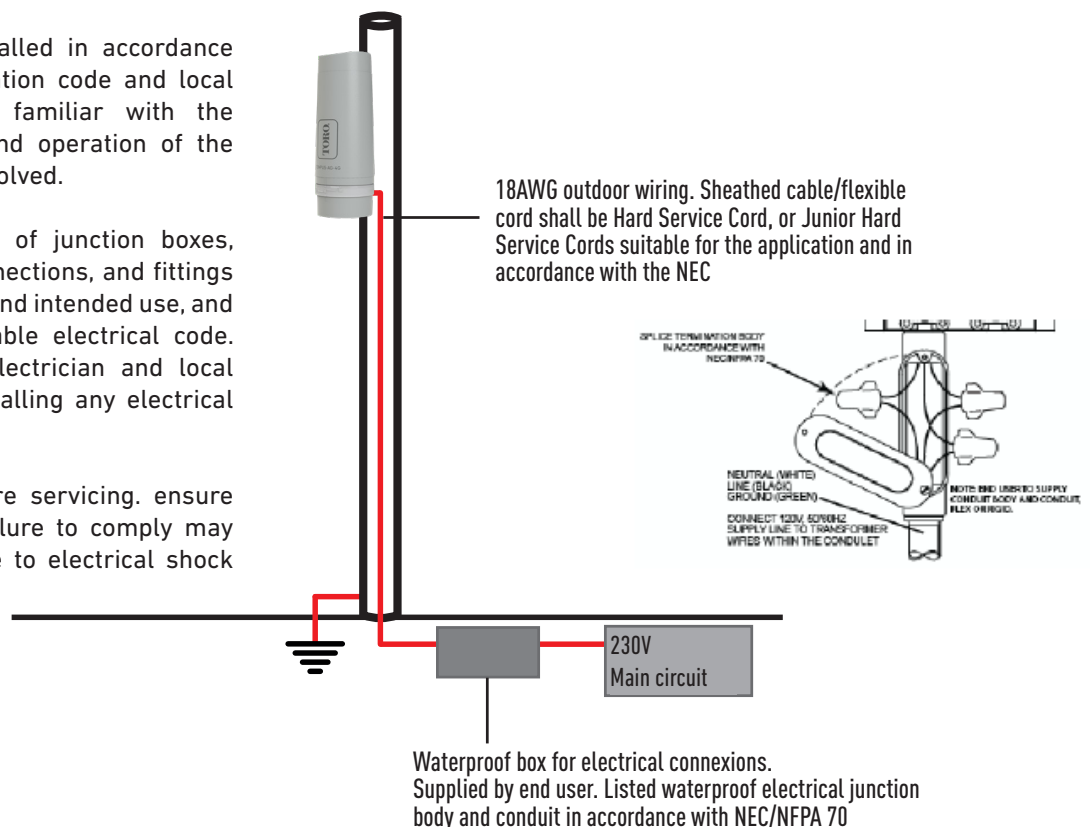



Prohibited connections

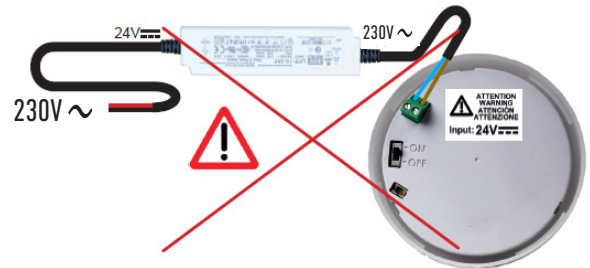
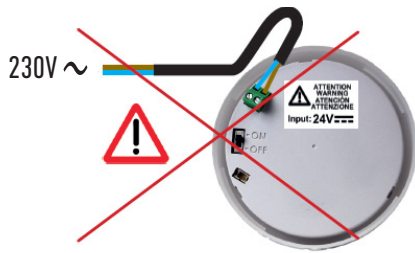

Recommendations of the power supply connection to the electricity network

- Use the power transformer supplied.
- Connect the 230Vac input of the transformer to the electrical network, protecting it with a 2A disconnecting circuit breaker.
- Connect the 24Vdc output of the transformer to the TEMPUS-AG-4G per NEC installation guidelines with suitable sheathed cable / flexible cord applicable for the intended application and water tight conduit and fittings. Sheathed cable / flexible cord shall be Hard Service Cord or Junior Hard Service Cord.
- Place the transformer and circuit breaker assembly in a Class II electrical box supplied by end user. Listed waterproof electrical junction body and conduit in accordance with NEC/NFPA 70.

1.2 Battery connection

- Connect the battery.

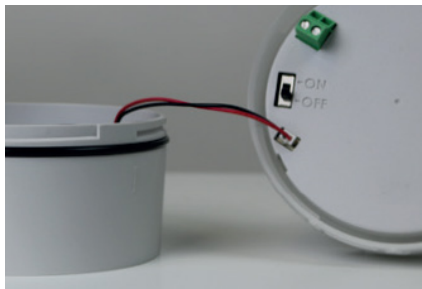

- Set the switch to ON

During the first installation it is necessary to charge the TEMPUS-AG-4G battery for 24 hours with 230VAC power before turning it ON.

Upon startup, the TEMPUS-AG-4G LEDs will flash red. Pair the TEMPUS-AG-4G, in the MyToroTempus App via Bluetooth, to your MyToroTempus account, following STEP 2. (We remind you that the SIM Card must be activated). The LEDs will turn green for one hour after pairing to indicate that the product is operational.

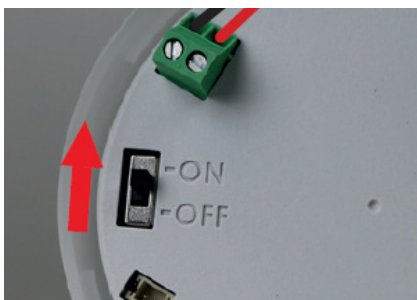

1.3 Reassembly the TEMPUS-AG-4G

- Adjust the length of the cable by pulling on it.
- Fit the parts together by applying strong pressure and lock the 2 parts.

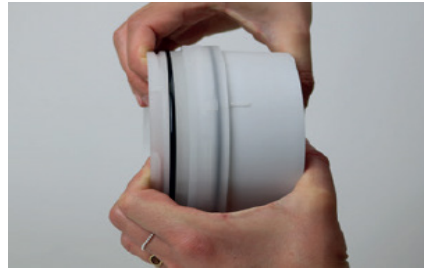

- Adjust the cable.



- Tighten the anti-traction.



Close the TEMPUS-AG-4G

- Close the lower and upper parts using the locking pictograms



Step 2

MYTOROTEMPUS APP DOWNLOADING

1. On your smartphone or tablet, go to the «App Store» or to the «Play Store» app.



2. Search for «The Toro Company» in the search bar.

Developer

The Toro Company



3. Once found, download the MyToroTempus App



4. Once installed, activate the Bluetooth® of your smartphone or tablet.

CREATE AN ACCOUNT

To use TEMPUS-AG-4G, you need to create a MyToroTempus account

1. Launch MyToroTempus app from your smartphone and/or tablet.

2. Select the "Registration" button.

3. Follow the steps described on the app.

Note: if you already have an account on the MyToroTempusAG.com platform, you must use the same credentials

ASSOCIATION OF TEMPUS-AG-4G WITH MYTOROTEMPUS APP

1. Verify that the Bluetooth® is activated on the settings of your smartphone.

2. Launch MyToroTempus App from your smartphone and/or tablet.



3. Click on the « Add a controller » button or on the «+» button

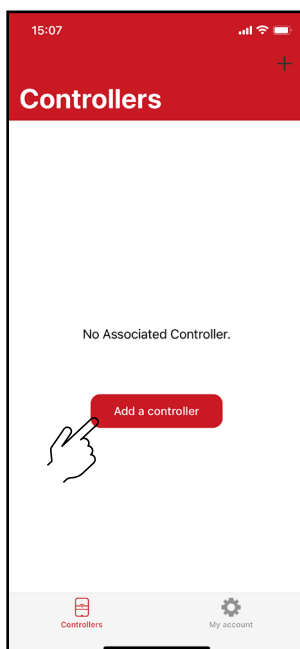

No device already installed

OR



Devices are already installed

4. Select the TEMPUS-AG-4G picture from the devices list

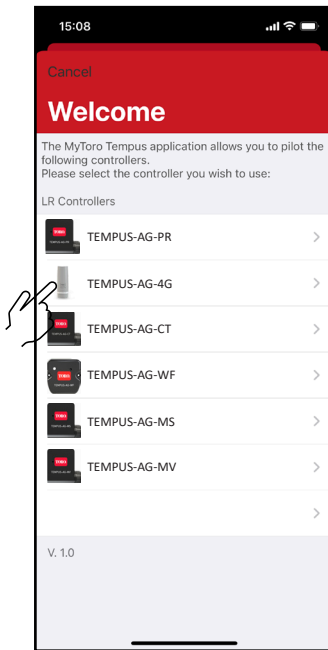

5. Select the required TEMPUS-AG-4G to be installed from the list of the available devices

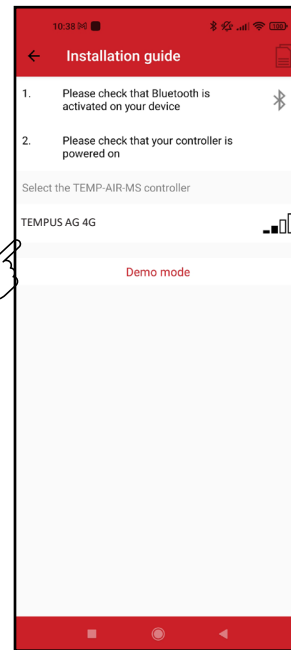

Note 1: To identify your TEMPUS-AG-4G among the nearby 4G gateways, please refer to the «Default name» present on its product label.

Note 2: Please, note, from the first 2 minutes that you power on the product, the "Default name" will appear in red.

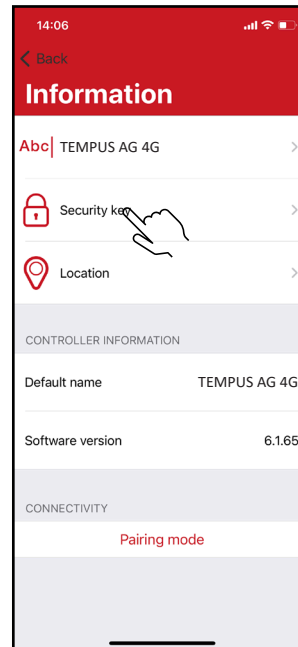
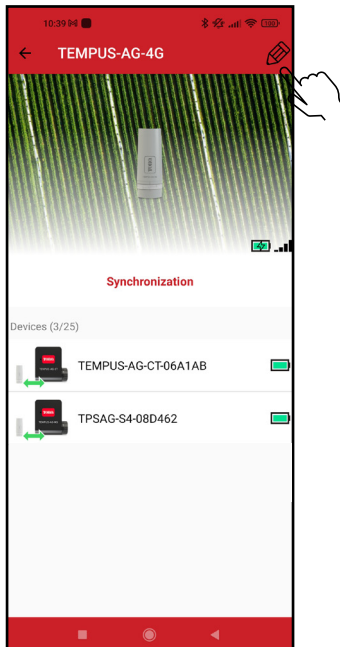

Security key

The security key allows to protect your Gateway. You can define it during the «ASSOCIATION» or access to further information by clicking on the icon "Pencil" at the top right of your screen.

LED STATUS

The LEDs are functional for one hour when starting the TEMPUS-AG-4G
Beyond this period the TEMPUS-AG-4G goes into standby mode.

- **Green LED:** normal operating (connected with the platform)
- **Flashing green LED:** LoRa™ communication
- **Red LED flashing 3 times:** Loss of GSM network.
- **Red LED flashing twice:** Hour alarm:

The TEMPUS-AG-4G is out of date. If your product is connected to the MyToroTempusAG platform, the time update will be automatic.

Otherwise connect to the TEMPUS-AG-4G from the MyToroTempus application and verify that the message "Synchronization OK" is displayed.

- **Flashing white LEDs:** Searching for the best network.
- **Flashing blue LEDs:** Platform communication

Step 3

PAIRING DEVICES

To associate a TEMPUS-AG-CT/MS/MV/PR, refer to the following example.

Example of a radio association between an TEMPUS-AG device and the TEMPUS-AG-4G :

You must first have associated your TEMPUS-AG device with your account in MyToroTempus application before proceeding with the association of the device on your TEMPUS-AG-4G gateway. Refer to the user manual to associate it and then perform the following steps.

1. Select the product in the list of devices (Remember that you must be connected to your device via Bluetooth).

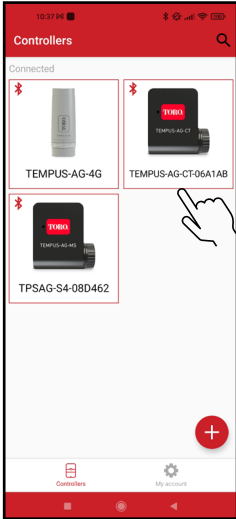

Push on  on the top right of the screen to access to information of the products. (Example with a TEMPUS-AG-CT)

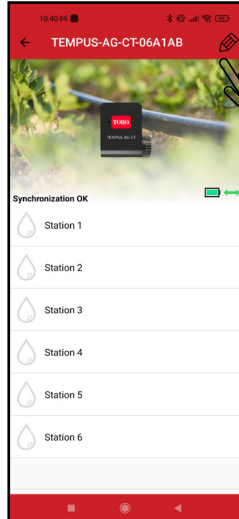

2. Push on « Remote access »

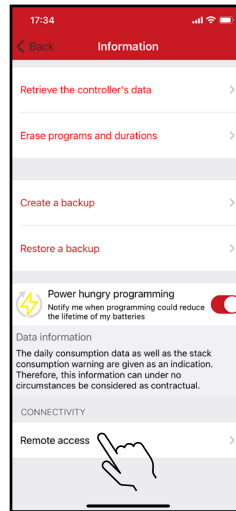

3. Select your TEMPUS-AG-4G (Refer to the «Default name» present on its product label)



4. Push on Transmit to validate the operation.

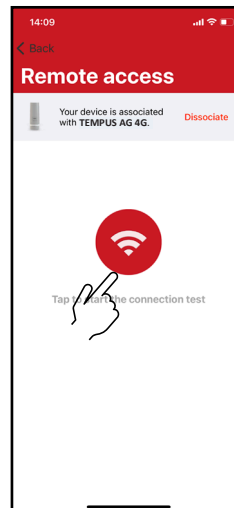
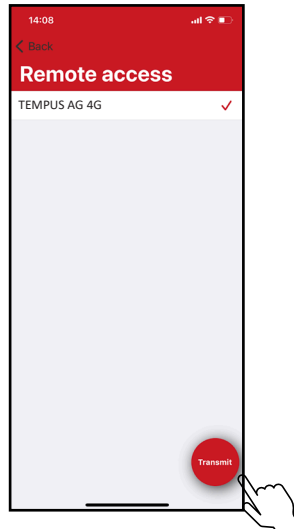

5. Your TEMPUS-AG-4G-A/CT/MS/PR/MV is now associated to your TEMPUS-AG-4G gateway.

Step 4

LoRa™ TEST CONNECTION

If the association of the devices is carried out before the final installation of the TEMPUS-AG-4G, this connection test can be used to validate the positioning of the latter by going to temporarily install the TEMPUS-AG-4G in its intended location then by going to position a device in each of the valve box to verify the good communication with the TEMPUS-AG-4G.

The connection test can also allow you to verify at any time the correct operation of the LoRa™ radio between your device and the TEMPUS-AG-4G.

(Example: the product fell into the upside-down valve box and no longer communicates with the TEMPUS-AG-4G).

To test the LoRa™ connection, do the following:

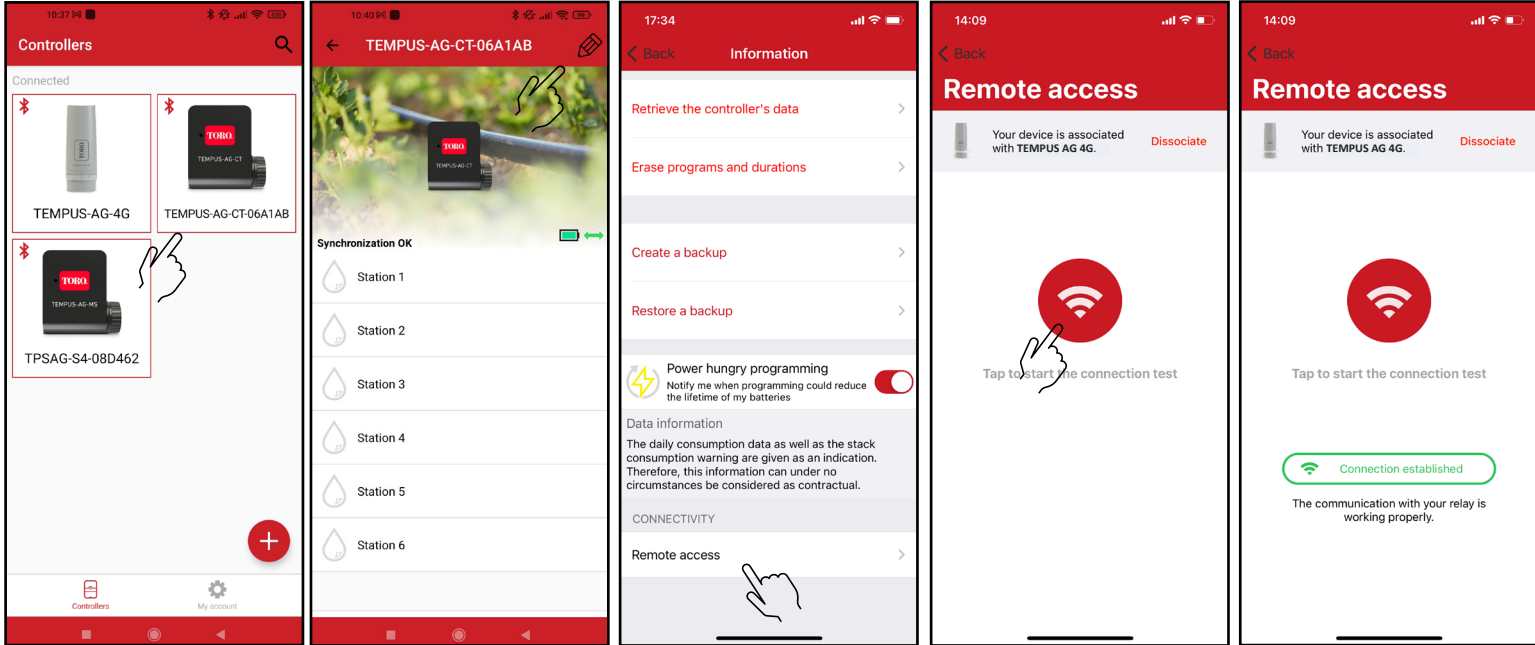

1. Enter the TEMPUS-AG device in Bluetooth®

Then in the parameters (small pencil at the top right)

2. Push on « Remote access »

3. Push the red button to test the connection LoRa™

4. The message indicate that the LoRa™ connection between the TEMPUS-AG-4G and the device is reliable.

If the connection is not established, a "No connection established" message appears. Repeat this test several times to confirm that the connection cannot be made. In this case, the distance between the TEMPUS-AG-4G and the TEMPUS-AG device will need to be reduced.

LoRa™ STATUS CONNECTION

During the first installation it is necessary to charge the TEMPUS-AG-4G battery for 24 hours with 230VAC power before turning it ON.







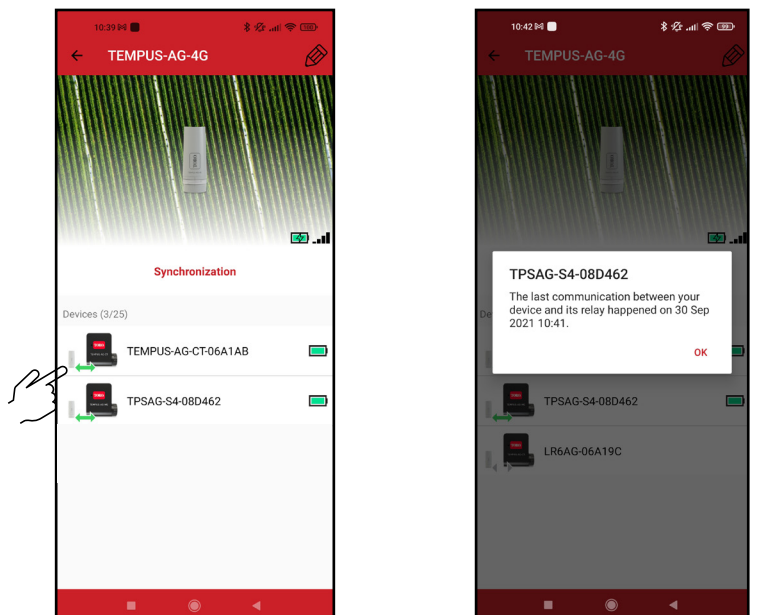
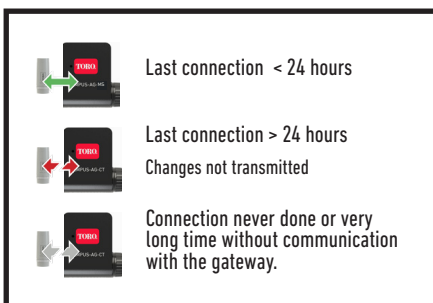

Preamble :

• The communication periodicity in LoRa™ mode :

The communication interval of the LoRa™ radio between the TEMPUS-AG(-xx) devices and TEMPUS-AG-4G is approximately 3 minutes (Battery full charged). You can see the TEMPUS-AG-4G's power mode and its battery charge status in the table on the next page.

• **Status of LoRa™ radio communication between the devices and the TEMPUS-AG-4G.** These icons indicate when the TEMPUS-AG-4G was last connected to a device via LoRa™.



Power supply mode	Battery Status	Periodicity	
		LoRa™	Internet
220-240VAC Power supply or Solar panel	Ended Charge 	The LoRa™ radio of the TEMPUS AG 4G gateway is always activated.	Communication 3G/4G corresponding to the subscription 24 communications per day.
220-240VAC Power supply or Solar panel	Battery charging 		
Battery			
Battery			
Battery			
Battery			
Battery		Out of service until the battery has regained a sufficient voltage level	
Battery			

Step 5

POLE MOUNTING

- Prepare the bracket with the 2 collars.



- Prepare the 2 gateway supports with the 2 collars.



- First fix the bracket on the pole.



- Then fix the 2 TEMPUS-AG-4G supports on the pole with the 2 collars.
- Do not fully tighten the collars to permit the positioning of the TEMPUS-AG-4G.



- Place the TEMPUS-AG-4G on the bracket and secure it with the clasper. If necessary readjust the height of the 2 plastic supports as well as the position of the square.



- Once properly positioned, correctly tighten all clasper cut off the excess collar.



NOTE: TEMPUS-AG-4G can also be wall mounted.

Step 6

SOLAR PANEL ASSEMBLY

The solar panel can be mounted on the wall or on a pole 40 to 60 mm in diameter, or with the addition of jaws on a pole of 60 to 230 mm.



FOR THE DETAILS OF THE ASSEMBLY OF THE PANEL AND THE FLANGES, REFER TO THE INSTRUCTIONS PROVIDED IN THE BOX OF BINDINGS

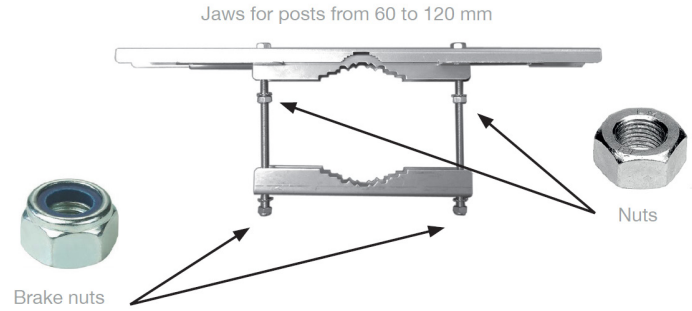

Solar Panel Connection

During the first installation, before connecting the solar panel, it is necessary to charge the TEMPUS-AG-4G battery, turned off, for 24 hours with 230 VAC power supply. After 24h of charging, disconnect the transformer and connect the solar panel.

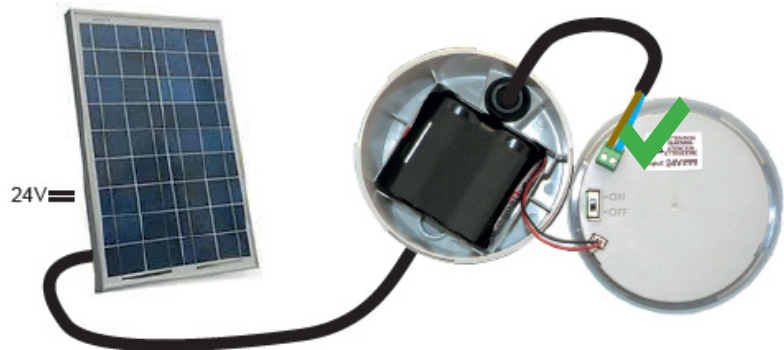

Prohibited connections

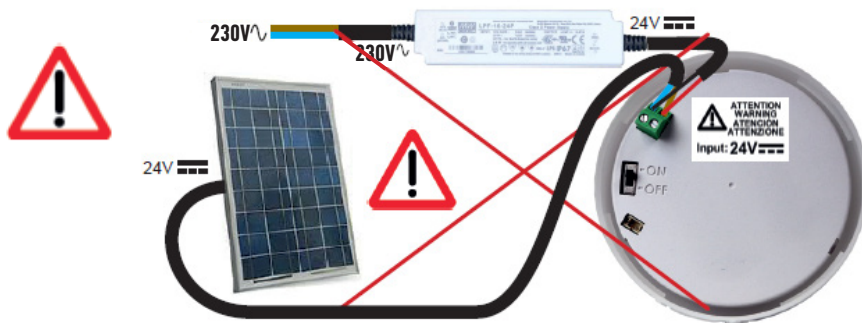

SOLAR PANEL ASSEMBLY HIGH WIND FIXATION

The Solar panel has another type of attachment sold apart from the so-called "high wind" for exposures of the solar panel to winds above 50kmph.

FOR THE DETAILS OF THE ASSEMBLY OF THE PANEL AND THE FLANGES, REFER TO THE INSTRUCTIONS PROVIDED IN THE BOX OF BINDINGS



DECLARATION OF CONFORMITY

The Toro Company (Toro AG), 1588 N. Marshall Avenue, El Cajon, CA, 92020-1523, USA declare that TEMPUS-AG-4G conform(s) to the following directives, standards and/or other normative documents:

Safety standard

IEC 62368-1 (2014)
IEC 60950-22 (2016)

EMC standards :

ETSI/EN 301 489-1 v2.2.3
ETSI EN 301 489-3 v2.1.1 (SRD)
ETSI EN 301 489-17 v3.2.4 (2,4GHz & 5 GHz)
ETSI EN Draft 301489-52 v1.1.0 ((2G, 3G, 4G)

Radio standards :

2G : EN/ETSI 301 511 v12.5.1 and TS 151 010-1 v13.4.0
3G : EN/ETSI 301908-1 v13.1.1
4G LTE : EN/ETSI 301908-1 v13.1.1
EMF : EN 62311 (2008) and recommendation 1999/519/EC

GENERAL INFORMATION

 This symbol indicates that the product uses a LoRa™ technology radio.



This symbol indicates that these types of electrical and electronic equipment must be disposed of separately in. Do not dispose of this device with your household waste. Please use the collection and recycling points available in your State when you no longer need this device.



In case of contrary use to the indications given in this user manual, the device protection may be compromised.



This symbol indicates that the supply voltage is a direct voltage.

TEMPUS-AG-4G
4G-LoRa™ Gateway



©2023 The Toro Company
Toro Australia
53 Howards Road, Beverley, SA, 5009

| For more information visit thelandscapestore.com.au | (02) 9161 3939 |



TEMPUS AG Controller CT 1-2-4-6 Stations



TEMPUS-AG-CT

Controller 1-2-4-6 Stations



INTRODUCTION

TEMPUS-AG-CT is a Bluetooth®/LoRa™, battery-powered, waterproof controller. It is available in 1, 2, 4 or 6 stations. Its probe input allows the connection to a rain sensor or a flow meter / water meter or pressure switch.

SPECIFICATION

DIMENSIONS

Width: 10,8 cm
Height: 4,8 cm
Depth: 11,6 cm

INSTALLATION

Rain sensor or Water meter connection
or pressure switch
Master valve connection
9V latching solenoid compatible
Maximum wiring length with solenoids: 30 m
100% waterproof (rated IP68)

POWER SUPPLY

9V 6AM6 or 6LR61 Alkaline battery (not included)
Current consumption : 0.1mA

USE

Ambient temperature of product use: -20°C to 50°C
Use in humid environment IP68
(test conditions: 1h at 1m depth)
Altitude use up to 2000m
Indoor and outdoor use
Pollution level 2
Maximum relative humidity of 80% for temperatures up to 31°C
and linear decrease up to 50% of relative humidity at 40°C

FEATURES

Bluetooth® Smart 4.0 Low Energy
LoRa™ radio communication
Permanent programming save
Internal clock saved in case of power failure < 30 s

INSTALLATION GUIDELINES

The TEMPUS-AG-CT is made for an outdoor use. You can place it in a buried valve box or set it on a wall (concrete, brick, cinder blocks) with 2 dowels and 2 countersunk screws of 4X40 not included.

In order to clean the TEMPUS-AG-CT, use soapy water with a sponge and then a soft cloth to wipe it off.

Step 1

APP DOWNLOAD

1. On your smartphone or tablet, go to the «App Store» or to the «Play Store».



2. Search for «The Toro Company» in the search bar.

Developer
The Toro Company



3. Once found, download the MyToroTempus App



4. Once installed, activate the Bluetooth® of your smartphone or tablet.

CREATE AN ACCOUNT

To use TEMPUS-AG-4G / CT / MS, you need to create your MyToroTempus account.

1. Launch MyToroTempus app from your smartphone and/or tablet.

2. Go to «My account» by typing  on icon.

3. Follow the steps described on the app.

Note: if you already have an account on the MyToroTempusAG.com platform, you must use the same credentials.

| For more information visit thelandscapestore.com.au | (02) 9161 3939 |

ASSOCIATION

1. Unscrew the TEMPUS-AG-CT 's cap
2. Plug the 9V 6LR61 ou 6AM6 battery and screw the cap
3. Launch MyToroTempus app from your smartphone or tablet.
4. Click on the «Add a controller» button or on the «+» button
5. Choose the TEMPUS-AG-CT from the available controllers list.
6. (Optional) Define a name and a security key for your controller and click on the button «Validate».
7. To finish your TEMPUS-AG-CT pairing, follow the next steps described in the app.



Note: To identify your TEMPUS-AG-CT among the nearby controllers, please refer to the «Default name» present on its product label.

Security key

The security key allows to protect your controller. You can define it during the step 6 of the «ASSOCIATION» or access to further information by clicking on the icon  at the top right of your screen.

PAIRING WITH TEMPUS-AG-4G/WF

To optimize the LoRa™ radio connection between the TEMPUS-AG-4G/WF and the TEMPUS-AG-CT controllers, we advise to install the TEMPUS-AG-CT under 800 meters to the TEMPUS-AG-4G/WF. We also advise to associate all your TEMPUS-AG Controller near the TEMPUS-AG-4G/WF before installing them in the valve boxes.

1. On the MyToroTempus mobile App, select your TEMPUS-AG-4G/WF, and enter pairing mode on the Information screen. (You must be connected via Bluetooth)
2. Select the TEMPUS-AG-CT previously installed.
3. Click on the top right icon  to access to the product's informations.
4. Click on «Remote Access».
5. Select the TEMPUS-AG-4G/WF you want to pair the controller with.
6. Click on the button «Send» or  on the bottom of your screen to validate. Once the pairing finished, you can test the connection between your TEMPUS-AG-4G/WF and your TEMPUS-AG-CT
7. Go back to «Remote access» screen.
8. Click on the button  to start the test.

Note:

- The message «Connection established» means that the connection is reliable.
- The message «No connection established» means that it is necessary to bring the TEMPUS-AG-CT closer to the TEMPUS-AG-4G/WF or vice versa.

WIRING

1. Connect the TEMPUS-AG-CT to the solenoids as described below. Use 9V pulse valves only.

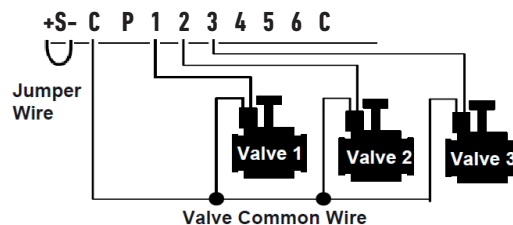

2. You can connect on the P output a master valve or a Pump Start Relay. The output will automatically start 2s before the start of each station.

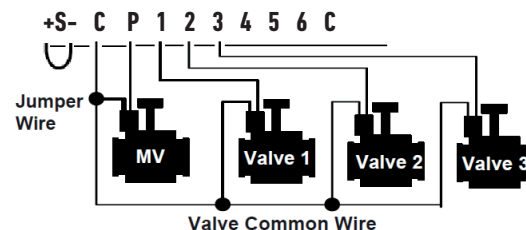

SET SENSOR



Warning, by default there are no sensor configured.

The TEMPUS-AG-CT has a + S - sensor input on which you can connect a rain sensor or a flow meter/water meter or pressure switch after cutting the blue wire. Once the sensor is connected, it is necessary to configure it in the application.

1. Using the MyToroTempus mobile app, connect to your TEMPUS-AG-CT via Bluetooth.
2. Click on Add Sensor.
3. Select your sensor type and follow the instructions given by the application

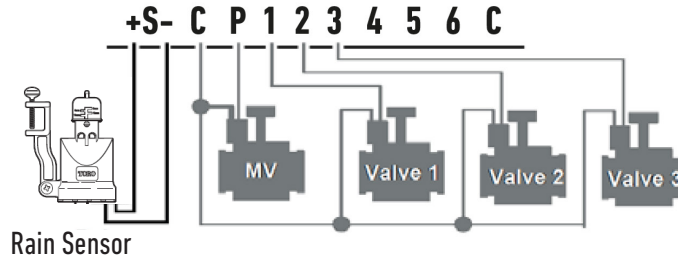

SET FLOWMETER

1. Check the «Instant Value».

Instant Value: Ensures that the volume consumed indicated on the water meter is the same as the volume displayed on the application. If a gap is noted, check the wiring (polarity) or adjust the «COEFFICIENT» value.

2. Fill in the remaining fields.

High threshold (daily volume): maximum consumption (in liter) that you do not want to exceed in a period of 24h. If the goal is exceeded you will be alerted immediately (by e-mail and notification smartphone and / or tablet).

Low threshold (daily volume): minimum consumption (in liters) that you want to achieve over a period of 24h. If the goal is not reached you will be alerted the next day at 7am (by e-mail and notification smartphone and / or tablet).

Leak alert volume: water volume threshold (in liter) from which you want to be alerted.

Station flow: for each station, read the flowmeter at time T (Cpt1), then at time T + 5mn (Cpt2).

Make the calculation $(Cpt2 - Cpt1) / 5 \Rightarrow \text{Flow (L / min)}$

In the application fill in the results.

High Threshold (Station Flow Alerts): Maximum consumption warning threshold in % of the calibrated flow of the channel. The «High threshold» alert is immediate as soon as it is reached.

Low threshold (Station Flow Alerts): Minimum consumption warning threshold in % of the calibrated flow of the channel. The «High threshold» alert is immediate as soon as it is reached. For each station flow alert you have the possibility to define the desired type of action:

- **No action:** watering continues.
- **Permanent OFF:** resuming watering requires a manual ON command (in the application on the programmer concerned).
- **Inhibit the output:** stops the station concerned, requires the acknowledgment of the alert (in the application on the programmer concerned) to reactivate the station.

Stabilization time:

Time required before the water flow is stable when starting and stopping the station. It eliminates the peak flow (start) or leak (stop). The time is the same for all stations. During this period, the consumption is not taken into account for triggering alerts or actions.

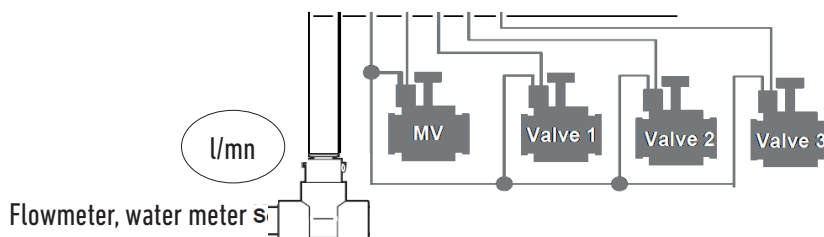

Connect your + S - input to a water meter equipped with a flow sensor as shown above. Use dry contact flow sensors or equivalent. For polarized flow sensors, when wiring, observe the polarization : **Red wire -> + Black wire -> -**

FAQ

What are the features required for the Bluetooth® product to work?

Android 4.3 (or more) Smartphones or tablets equipped with Bluetooth Smart 4.0 (or more). iOS 9.0 Apple iPhone or iPad running (or more) with Bluetooth Smart 4.0 (or more)

What is output P for?

You can connect a master valve or a pump through a relay, on P output. It will start automatically during each station watering.

What are the controller's output S (blue wire) for?

You can plug a rain sensor into S outputs, to do that you need to cut the blue wire.

How does the rain sensor work?

When connected to the wire the rain sensor acts on the stations. If it is raining, stations won't start; you must wait for the probe to dry before the programming star again. The manual control is not affected by the rain sensor conditions.

How can I restart the pairing or the pairing procedure?

To start the pairing procedure again, just bypass the 2 battery connector pins (battery removed) for 30s minimum

If my device has no more battery, do I lose my programming?

No, they are not lost, it is automatically saved.

DECLARATION OF CONFORMITY

The Toro Company (Toro AG), 1588 N. Marshall Avenue, El Cajon, CA, 92020-1523, USA declare that TEMPUS-AG-CT conform(s) to the following directives, standards and/or other normative documents:

EMC

172376-764709-B: FCC CFR 47 Part 15, Subpart B

Transmissions

HBCS Report # EMC_15028_2 Rev1: LoRa module 915- 927.5MHz The manufacturer declaration 10 Oct 2022, states that LoRa frequencies in use are: 920.2, 920.4, 920.6MHz; RF power less than 20dBm

FCC CFR 47 Part 15, Subpart C (BLE 2,4 GHz)

Safety

IEC 61010-1: 2010 + A1:2016

IEC 61010-2-030: 2017

IEC 61010-2-201: 2017

CB cert FR_713395

LoRa Module

Microchip RN2903 LoRa™ module 920 MHz HB Compliance Solutions report EMC_15028_2 Rev1 26 May 2016. Covering:

FCC title 47 of the CFR Part 51.247 (Digital transmitting device)

GENERAL INFORMATION



This symbol indicates that the product uses a LoRa™ technology radio.



This symbol indicates that these types of electrical and electronic equipment must be disposed of separately in . Do not dispose of this device with your household waste. Please use the collection and recycling points available in your State when you no longer need this device.



In case of contrary use to the indications given in this user manual, the device protection may be compromised.



This symbol indicates that the product is shock resistant.



This symbol indicates that the product is resistant to ultra violet.



This symbol indicates that the product is waterproof.



This symbol indicates that the supply voltage is a direct voltage.

FCC/IC STATEMENT TEMPUS-AG-CT

This product contains a modular approval with FCC ID : YWW-BLEMOD, T9JRN2903 and IC : 9319A-BLEMOD, 6514A-RN2903.

This device complies with Part 15 of the FCC rules. Operation is subject to the following two conditions : (1) this device may not cause harmful interference, and (2) this device must accept any interference received, including interference that may cause undesired operation.

Caution : the user that changes or modifications not expressly approved by the party responsible for compliance could void the user's authority to operate the equipment.

Note : this equipment has been tested and found to comply with the limits for a Class B digital device , pursuant to part 15 of the FCC Rules. These limits are designed to provide reasonable protection against harmful interference in a residential installation. This equipment generates, uses and can radiate radio frequency energy and, if not installed and used in accordance with the instruction, may cause harmful interference to radio communication. However, there is no guarantee that interference will not occur in a particular installation. If this equipment does cause harmful interference to radio or television reception which can be determined by turning the equipment off and on ,the user is encouraged to try to correct interference by one or more of the following measures :

- Reorient or relocate the receiving antenna.
 - Increase the separation between the equipment and receiver.
 - Connect the equipment into an outlet on a circuit different from that to which the receiver is connected.
 - Consult the dealer or an experienced radio/TV technician for help.
- This device contains licence-exempt transmitter(s)/receiver(s) that comply with innovation, science and Economic development Canada's licence-exempt RSS(s).

Operation is subject to the following two conditions : (1) this device may not cause interference, and (2) This device must accept any interference, including interference that may cause undesired operation of the device.

This device complies with FCC and ISED RF radiation exposure limits set forth for general population. This device must be installed to provide a separation distance of at least 20cm from all persons and must not be co-located or operating in conjunction with any other antenna or transmitter.

TEMPUS-AG-CT



©2023 The Toro Company
Toro Australia
53 Howards Road, Beverley, SA, 5009

| For more information visit thelandscapestore.com.au | (02) 9161 3939 |



TEMPUS-AG-MS

1-4 Sensor inputs



TEMPUS-AG-MS

Multi sensor device 1-4 Inputs



INTRODUCTION

TEMPUS-AG-MS is a battery powered Bluetooth® / LoRa™, Multi Sensor device. This device allows the acquisition of measurements from sensors of temperature, humidity, flow, wind speed. TEMPUS-AG-MS transmits data via LoRa connection to a TEMPUS-AG-4G/WF gateway. TEMPUS-AG-MS available in two models : MS-4 with 4 inputs (3 sensor inputs and 1 temperature input) and MS-1 with 1 input (1 sensor input).

SPECIFICATION

DIMENSIONS

Width: 10,5 cm

Height: 4,8 cm

Depth: 11,6 cm

FEATURES

Bluetooth® Smart 4.0 Low Energy

LoRa™ radio communication

Permanent programming memory

USE

Resolution level 2

Maximum relative humidity of 80% for temperatures up to 31°C and linear decrease up to 50% of relative humidity at 40°C

Indoor and outdoor use

Use in humid environment IP68

(test conditions: 1h at 1m depth)

Operating temperature: from -20°C to 50°C

Altitude use up to 2000m

POWER SUPPLY

9V 6AM6 ou 6LR61 Alkaline battery

Not included

Current consumption : 0.1mA

INSTALLATION

1 (MS-1) or 3 (MS-4) configurable inputs to choose from:

• Dry contact (rain sensor, wind sensor, ...)

• Pulse (flowmeter, wind sensor, ...)

• Analog (0-3.5V) (moisture sensor, tensiometer, ...)

1 (MS-4 only) temperature acquisition input (type Pt100) 3V5 supply sensor
The voltage value assigned to each mounted terminals is 3.3V (red wire to each inputs).

Note: the referenced sensors in this user manual are the ones recommended for the TEMPUS-AG-MS use.

INSTALLATION GUIDELINES

The TEMPUS-AG-MS is made for an outdoor use. You can place it in a buried valve box or set it on a wall (concrete, brick, cinder blocks) with 2 dowels and 2 countersunk screws of 4X40 not included.

In order to clean the TEMPUS-AG-MS, use soapy water with a sponge and then a soft cloth to wipe it off.

Step 1

APP DOWNLOAD

1. On your smartphone or tablet, go to the «App Store» or to the «Play Store».



2. Search for «The Toro Company» in the search bar.

Developer
The Toro Company



3. Once found, download the MyToroTempus App



4. Once installed, activate the Bluetooth® of your smartphone or tablet.

CREATE AN ACCOUNT

To use TEMPUS-AG-4G / CT / MS, you need to create your MyToroTempus account.

1. Launch MyToroTempus app from your smartphone and/or tablet.

2. Go to «My account» by typing  on icon.

3. Follow the steps described on the app.

Note: if you already have an account on the MyToroTempusAG.com platform, you must use the same credentials.

| For more information visit thelandscapestore.com.au | (02) 9161 3939 |

Step 2

ASSOCIATION

1. Unscrew the TEMPUS-AG-MS 's cap
2. Plug the 9V 6LR61 ou 6AM6 battery and screw the cap
3. Sign in with your MyToroTempus account
4. Launch MyToroTempus app from your smartphone or tablet.
5. Click on the «Add a controller» button or on the «<+>» button
6. Choose the TEMPUS-AG-MS from the available controllers list.
7. To finish your TEMPUS-AG-MS pairing, follow the next steps described in the app.

Note: To identify your TEMPUS-AG-MS among the nearby controllers, please refer to the «Default name» present on its product label.



Security key

The security key allows to protect your controller. You can define it during the step 6 of the «ASSOCIATION» or access to further information by clicking on the icon  at the top right of your screen.

Step 3

PAIRING WITH TEMPUS-AG-4G/WF

To optimize the LoRa™ radio connection between the TEMPUS-AG-4G/WF and the TEMPUS-AG-MS device, we advise to install the TEMPUS-AG-MS under 800 meters to the TEMPUS-AG-4G/WF. We also advise to associate all your Tempus AG device near the TEMPUS-AG-4G/WF before installing them.

1. On the MyToroTempus mobile App, select your TEMPUS-AG-4G/WF and enter pairing mode on the Information screen. (You must be connected via Bluetooth)
2. Select the TEMPUS-AG-MS previously installed.
3. Click on the top right icon  to access to the product's informations.
4. Click on «Remote Access».
5. Select the TEMPUS-AG-4G/WF you want to pair the device with.
6. Click on the button «Send» or  on the bottom of your screen to validate. Once the pairing finished, you can test the connection between your TEMPUS-AG-4G/WF and your TEMPUS-AG-MS
7. Go back to «Remote access» screen.
8. Click on the button  to start the test.

Note:

- The message «Connection established» means that the connection is reliable.
- The message «No connection established» means that it is necessary to bring the TEMPUS-AG-CT closer to the TEMPUS-AG-4G/WF or vice versa.

Step 4

SENSOR INSTALLATION

To ease the sensor installation we advise to follow the MyToroTempus mobile application instruction.

1. Get closer than 10 meters from TEMPUS-AG-MS and make sure your smartphone's Bluetooth is turned on.
2. Launch MyToroTempus app from your smartphone or tablet.
3. Select the TEMPUS-AG-MS previously installed. (The two devices, smartphone and MS device, must be connected via Bluetooth)
4. Click on "Add a sensor"
5. Select the type of sensor you want connect to your TEMPUS-AG-MS.
6. Select the sensor you want connect to your TEMPUS-AG-MS.
7. To properly connect the wiring and complete the sensor installation, follow the next steps described in the app.

WIRING

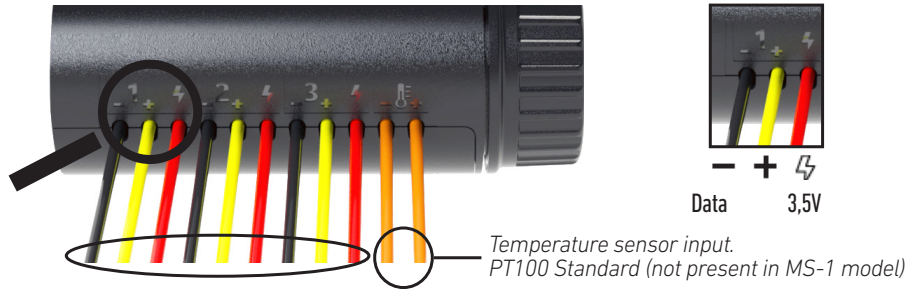

Configurable acquisition inputs (3 inputs for MS-4 model, 1 input for MS-1 model)

- Dry contact (rain sensor, anemometer, ...)
- Pulse (flowmeter, ...)
- Analog 0-3.5V (humidity sensor, solar radiation...)

Red wires: 3.5V power supply

Configurable sensor inputs (3 for MS-4, 1 for MS-1)

Note: The Tempus-AG-MS-1 has only 1 configurable acquisition input (three-wire entry) and it doesn't have temperature sensor input (two-wire entry).

Types of sensors that can be connected:

- Dry contact (rain sensor, wind sensor, ...)
- Pulse (flowmeter, wind sensor, ...)
- Analog (0-3.5V) (moisture sensor, solar radiation ...)

Example of connecting an analog input sensor: VH400 moisture sensor

The **black wire** (- Symbol) of your TEMPUS-AG-MS must be connected to the gray wire of the VH400 moisture sensor

The **yellow wire** (+ Symbol) of your TEMPUS-AG-MS must be connected to the **black wire** of the VH400 moisture sensor

The **red wire** (lampo Symbol) of your TEMPUS-AG-MS must be connected to the **red wire** of the VH400 moisture sensor

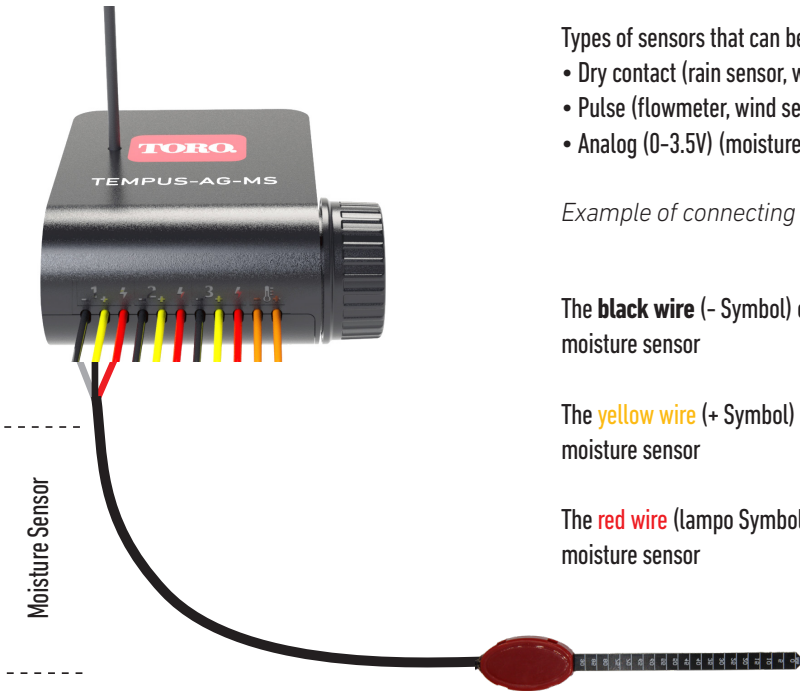

Note: the Tempus AG MS-1 has only one configurable sensor input.

Temperature sensor (MS-4 only)

Temperature sensor Input (PT100 Standard)

The **orange wire** (+ Symbol) of your TEMPUS-AG-MS must be connected to one of the two **red wires** of the temperature sensor

The **orange wire** (- Symbol) of your TEMPUS-AG-MS must be connected to the white wire of the temperature sensor

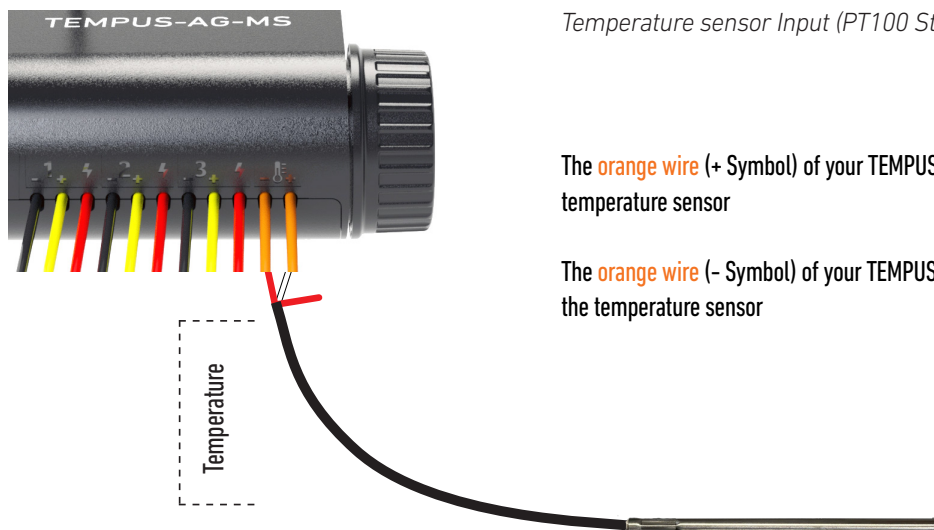

Note: the Tempus AG MS-1 doesn't have temperature sensor input.

DECLARATION OF CONFORMITY

The Toro Company (Toro AG), 1588 N. Marshall Avenue, El Cajon, CA, 92020-1523, USA declare that TEMPUS-AG-CT conform(s) to the following directives, standards and/or other normative documents:

EMC

FCC CFR 47 Part 15, Subpart B

Transmissions

HBCS Report # EMC_15028_2 Rev1: LoRa module. The manufacturer declaration 10 Oct 2022, states that LoRa frequencies in use are: 920.2, 920.4, 920.6MHz; RF power less than 20dBm

CFR 47 Part 15, Subpart C (BLE 2,4 GHz)

Safety

IEC 61010-1: 2010 (THIRD EDITION) +A1:2016

IEC 61010-2-030: 2017

CB cert FR_713209

LoRa Module

Microchip RN2903 LoRa™ module 920 MHz HB Compliance Solutions report EMC_15028_2 Rev1 26 May 2016. Covering:

FCC title 47 of the CFR Part 51.247 (Digital transmitting device)

GENERAL INFORMATION



This symbol indicates that the product uses a LoRa™ technology radio.



This symbol indicates that these types of electrical and electronic equipment must be disposed of separately in. Do not dispose of this device with your household waste. Please use the collection and recycling points available in your State when you no longer need this device.



In case of contrary use to the indications given in this user manual, the device protection may be compromised.



This symbol indicates that the product is shock resistant.



This symbol indicates that the product is resistant to ultra violet.



This symbol indicates that the product is waterproof.



This symbol indicates that the supply voltage is a direct voltage.

FCC/IC STATEMENT TEMPUS-AG-MS

This product contains a modular approval with FCC ID : YWW-BLEMOD, T9JRN2903 and IC : 9319A-BLEMOD, 6514A-RN2903.

This device complies with Part 15 of the FCC rules. Operation is subject to the following two conditions : (1) this device may not cause harmful interference, and (2) this device must accept any interference received, including interference that may cause undesired operation.

Caution : the user that changes or modifications not expressly approved by the party responsible for compliance could void the user's authority to operate the equipment.

Note : this equipment has been tested and found to comply with the limits for a Class B digital device , pursuant to part 15 of the FCC Rules. These limits are designed to provide reasonable protection against harmful interference in a residential installation. This equipment generates, uses and can radiate radio frequency energy and, if not installed and used in accordance with the instruction, may cause harmful interference to radio communication. However, there is no guarantee that interference will not occur in a particular installation. If this equipment does cause harmful interference to radio or television reception which can be determined by turning the equipment off and on, the user is encouraged to try to correct interference by one or more of the following measures :

- Reorient or relocate the receiving antenna.
 - Increase the separation between the equipment and receiver.
 - Connect the equipment into an outlet on a circuit different from that to which the receiver is connected.
 - Consult the dealer or an experienced radio/TV technician for help.
- This device contains licence-exempt transmitter(s)/receiver(s) that comply with innovation, science and Economic development Canada's licence-exempt RSS(s).

Operation is subject to the following two conditions : (1) this device may not cause interference, and (2) This device must accept any interference, including interference that may cause undesired operation of the device.

This device complies with FCC and ISED RF radiation exposure limits set forth for general population. This device must be installed to provide a separation distance of at least 20cm from all persons and must not be co-located or operating in conjunction with any other antenna or transmitter.

TEMPUS-AG-MS



©2023 The Toro Company
Toro Australia
53 Howards Road, Beverley, SA, 5009

| For more information visit thelandscapestore.com.au | (02) 9161 3939 |



TEMPUS-AG-MV 1 Station



TEMPUS-AG-MV

Main valve or pump controller



INTRODUCTION

The TEMPUS-AG-MV is a Bluetooth / LoRa connected device. This is a 9V battery supplied controller with an autonomy about approximately a year (the autonomy depends on the programming). It allows to manage a main valve or a pump (via a pump relay). It also offers a water meter input which can control the water flow from the same agriculture controllers network TEMPUS-AG-MV and transmit the information remotely through a TEMPUS-AG-4G / WF.

This product only operates in a controllers' cluster TEMPUS-AG-MV. The programming of this device is made automatically regarding the linked TEMPUS-AG-MV controllers programs, from the same network via MyToroTempusAG.com platform.

For any information regarding the app or the platform use, please refer to dedicated user manuals.

Main Valve use

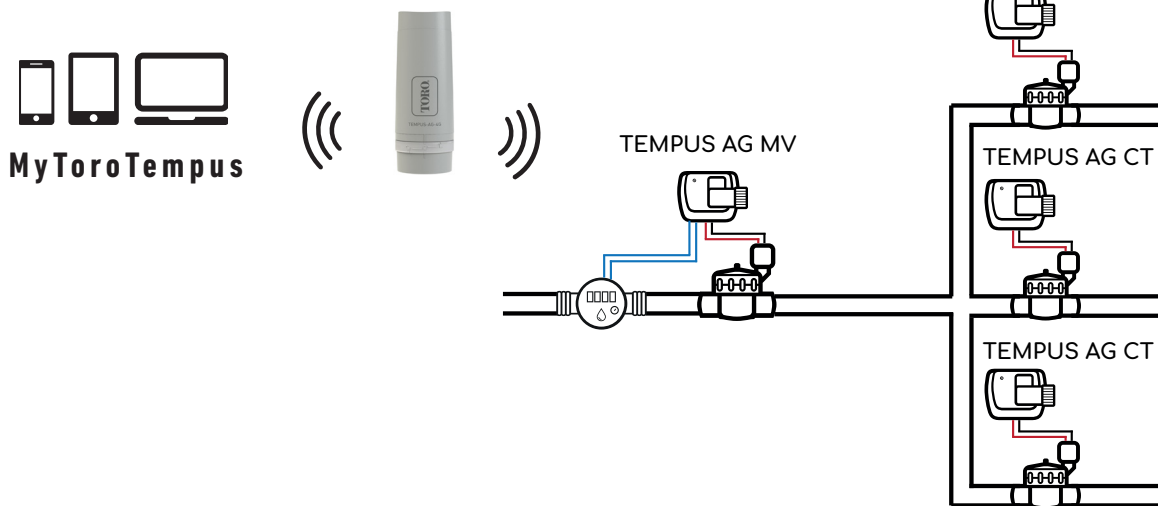

Pump use

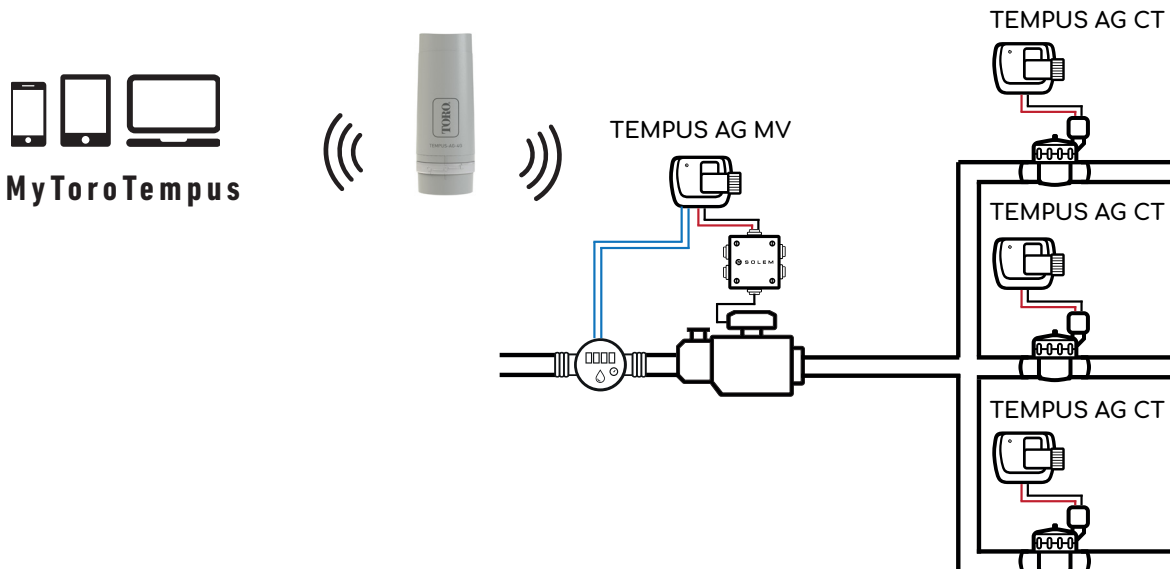

SPECIFICATION

DIMENSIONS

Width : 14 cm
Height : 9 cm
Depth : 5,5 cm

INSTALLATION

Connection to a rain sensor, water meter or pressure switch.
Connection to a master valve or pump relay.
Compatible with 9V pulse solenoid.
Maximum wiring length with solenoids: 30 m.

POWER SUPPLY

9V 6AM6 or 6LR61 Alkaline battery (not included)
Current consumption : 0.1mA

USE

Ambient temperature of product use: -20°C to 50°C
Use in humid environment IP68
(test conditions: 1h at 1m depth)
Altitude use up to 2000m
Indoor and outdoor use
Pollution level 2
Maximum relative humidity of 80% for temperatures up to 31°C
and linear decrease up to 50% of relative humidity at 40°C

FEATURES

Bluetooth® Smart 4.0 Low Energy
LoRa™ radio communication
Permanent programming save
Internal clock saved in case of power failure < 30 s

Installing the wrong type of battery may cause an explosion or fire hazard.

INSTALLATION GUIDELINES

The TEMPUS-AG-MV is made for an outdoor use. You can place it in a buried valve box or set it on a wall (concrete, brick, cinder blocks) with 2 dowels and 2 countersunk screws of 4X40 not included.

In order to clean the TEMPUS-AG-MV, use soapy water with a sponge and then a soft cloth to wipe it off.

Step 1

APP DOWNLOAD

1. On your smartphone or tablet, go to the «App Store» or to the «Play Store».



2. Search for «The Toro Company» in the search bar.

Developer
The Toro Company



3. Once found, download the MyToroTempus App



4. Once installed, activate the Bluetooth® of your smartphone or tablet.

CREATE AN ACCOUNT

To use your products, you need to create your MyToroTempus account.

1. Launch MyToroTempus app from your smartphone and/or tablet.

2. Select the "Registration" button.

3. Follow the steps described on the app.

Note: if you already have an account on the MyToroTempusAG.com platform, you must use the same credentials.

ASSOCIATION

1. Unscrew the TEMPUS-AG-MV 's cap
2. Plug the 9V 6LR61 ou 6AM6 battery and screw the cap
3. Launch MyToroTempus app from your smartphone or tablet.
4. Click on the «Add a controller» button or on the «+» button
5. Choose the TEMPUS-AG-MV from the available controllers list.
6. (Optional) Define a name and a security key for your controller and click on the button «Validate».
7. To finish your TEMPUS-AG-MV pairing, follow the next steps described in the app.



Note: To identify your TEMPUS-AG-MV among the nearby controllers, please refer to the «Default name» present on its product label.

Security key

The security key allows to protect your controller. You can define it during the step 6 of the «ASSOCIATION» or access to further information by clicking on the icon  at the top right of your screen.

PAIRING WITH TEMPUS-AG-4G/WF

To optimize the LoRa™ radio connection between the TEMPUS-AG-4G/WF and the TEMPUS-AG-MV controllers, we advise to install the TEMPUS-AG-MV under 800 meters to the TEMPUS-AG-4G/WF. We also advise to associate all your TEMPUS-AG Controller near the TEMPUS-AG-4G/WF before installing them in the valve boxes.

1. On the MyToroTempus mobile App, select your TEMPUS-AG-4G/WF, and enter pairing mode on the Information screen. (You must be connected via Bluetooth)
2. Select the TEMPUS-AG-MV previously installed.
3. Click on the top right icon  to access to the product's informations.
4. Click on «Remote Access».
5. Select the TEMPUS-AG-4G/WF you want to pair the controller with.
6. Click on the button «Send» or  on the bottom of your screen to validate. Once the pairing finished, you can test the connection between your TEMPUS-AG-4G/WF and your TEMPUS-AG-MV
7. Go back to «Remote access» screen.
8. Click on the button  to start the test.

Note:

- The message «Connection established» means that the connection is reliable.
- The message «No connection established» means that it is necessary to bring the TEMPUS-AG-MV closer to the TEMPUS-AG-4G/WF or vice versa.

SOLENOID VALVE / PUMP WIRING

1. Plug the TEMPUS-AG-MV as shown below. Use 9V solenoid valves only for a main valve and a relay for a pump use.

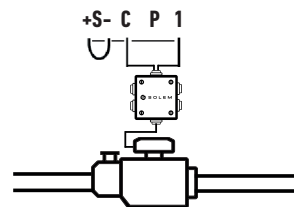
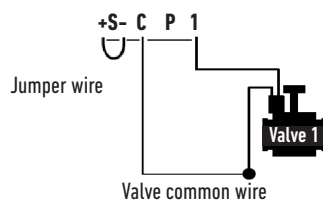

CHOICE AND SENSOR SETUP

 **Warning, by default there are no sensor configured.**

The TEMPUS-AG-MV has a + S - sensor input on which you can connect a rain sensor or a flow meter/water meter or pressure switch after cutting the blue wire. Once the sensor is connected, it is necessary to configure it in the application.

1. Using the MyToroTempus mobile app, connect to your TEMPUS-AG-MV via Bluetooth.
2. Click on Add Sensor.
3. Select your sensor type and follow the instructions given by the application.

Rain sensor

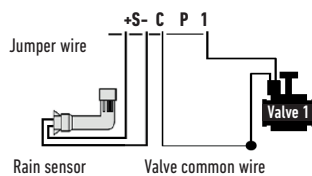

Pressure switch (AON = All or Nothing)

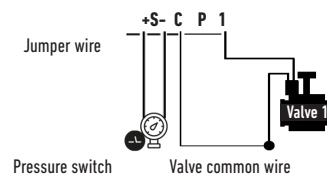

Water meter

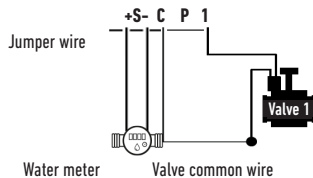

Connect your + S - input to a water meter equipped with a flow sensor as shown above. Use dry contact flow sensors or equivalent. For polarized flow sensors, when wiring, observe the polarization :

Red wire -> + Black wire - - -

Step 6

SET FLOWMETER

1. Check the «Instant Value».

Instant Value: Ensures that the volume consumed indicated on the water meter is the same as the volume displayed on the application. If a gap is noted, check the wiring (polarity) or adjust the «COEFFICIENT» value.

2. Fill in the remaining fields.

High threshold (daily volume): maximum consumption (in liter) that you do not want to exceed in a period of 24h. If the goal is exceeded you will be alerted immediately (by e-mail and notification smartphone and / or tablet).

Low threshold (daily volume): minimum consumption (in liters) that you want to achieve over a period of 24h. If the goal is not reached you will be alerted the next day at 7am (by e-mail and notification smartphone and / or tablet).

Leak alert volume: water volume threshold (in liter) from which you want to be alerted.

Station flow: for each station, read the flowmeter at time T (Cpt1), then at time

T + 5mn (Cpt2).

Make the calculation $(Cpt2 - Cpt1) / 5 \Rightarrow \text{Flow (L / min)}$

In the application fill in the results.

High Threshold (Station Flow Alerts): Maximum consumption warning threshold in % of the calibrated flow of the channel. The «High threshold» alert is immediate as soon as it is reached.

Low threshold (Station Flow Alerts): Minimum consumption warning threshold in % of the calibrated flow of the channel. The «High threshold» alert is immediate as soon as it is reached. For each station flow alert you have the possibility to define the desired type of action:

- **No action:** watering continues.
- **Permanent OFF:** resuming watering requires a manual ON command (in the application on the programmer concerned).
- **Inhibit the output:** stops the station concerned, requires the acknowledgment of the alert (in the application on the programmer concerned) to reactivate the station.

Stabilization time:

Time required before the water flow is stable when starting and stopping the station. It eliminates the peak flow (start) or leak (stop). The time is the same for all stations. During this period, the consumption is not taken into account for triggering alerts or actions.

Step 7

SET PRESSURE SWITCH

How to set up manually your pressure switch on the pipe :

1. The contact of the pressure switch is normally closed.
2. Put the pressure switch on the pipe.
3. Remove the cap on the head of the pressure switch.
4. Check that the value is 0 using the instant value connected in bluetooth with the App.
5. Open the irrigation and check if the value is 1.
6. To set it up precisely. During irrigation Screw the screw of the pressure switch until the instant value go to 0.
7. Then always during the irrigation, unscrew slowly a little bit more the screw in order to get again the 1.

Note: You can also use a multimeter instead of the using the instant value.

FAQ

What are the features required for the Bluetooth® product to work?

Android 4.3 (or more) Smartphones or tablets equipped with Bluetooth Smart 4.0 (or more). iOS 9.0 Apple iPhone or iPad running (or more) with Bluetooth Smart 4.0 (or more)

How does the rain sensor work?

When connected to the wire the rain sensor acts on the stations. If it is raining, stations won't start; you must wait for the probe to dry before the programming star again. The manual control is not affected by the rain sensor conditions.

How can I restart the pairing or the pairing procedure?

To start the pairing procedure again, just bypass the 2 battery connector pins (battery removed) for 30s minimum

If my device has no more battery, do I lose my programming?

No, they are not lost, it is automatically saved.

DECLARATION OF CONFORMITY

The Toro Company (Toro AG), 1588 N. Marshall Avenue, El Cajon, CA, 92020-1523, USA declare that TEMPUS-AG-CT conform(s) to the following directives, standards and/or other normative documents:

EMC

172376-764709-B: FCC CFR 47 Part 15, Subpart B

Transmissions

HBCS Report # EMC_15028_2 Rev1: LoRa module 915- 927.5MHz The manufacturer declaration 10 Oct 2022, states that LoRa frequencies in use are: 920.2, 920.4, 920.6MHz; RF power less than 20dBm

FCC CFR 47 Part 15, Subpart C (BLE 2,4 GHz)

Safety

IEC 61010-1: 2010 + A1:2016

IEC 61010-2-030: 2017

IEC 61010-2-201: 2017

CB cert FR_713395

LoRa Module

Microchip RN2903 LoRa™ module 920 MHz HB Compliance Solutions report EMC_15028_2 Rev1 26 May 2016. Covering:

FCC title 47 of the CFR Part 51.247 (Digital transmitting device)

GENERAL INFORMATION



This symbol indicates that the product uses a LoRa™ technology radio.



This symbol indicates that these types of electrical and electronic equipment must be disposed of separately in. Do not dispose of this device with your household waste. Please use the collection and recycling points available in your State when you no longer need this device.



In case of contrary use to the indications given in this user manual, the device protection may be compromised.



This symbol indicates that the product is shock resistant.



This symbol indicates that the product is resistant to ultra violet.



This symbol indicates that the product is waterproof.



This symbol indicates that the supply voltage is a direct voltage.

FCC/IC STATEMENT TEMPUS-AG-MV

This product contains a modular approval with FCC ID : YWW-BLEMOD, T9JRN2903 and IC : 9319A-BLEMOD, 6514A-RN2903.

This device complies with Part 15 of the FCC rules. Operation is subject to the following two conditions : (1) this device may not cause harmful interference, and (2) this device must accept any interference received, including interference that may cause undesired operation.

Caution : the user that changes or modifications not expressly approved by the party responsible for compliance could void the user's authority to operate the equipment.

Note : this equipment has been tested and found to comply with the limits for a Class B digital device , pursuant to part 15 of the FCC Rules. These limits are designed to provide reasonable protection against harmful interference in a residential installation. This equipment generates, uses and can radiate radio frequency energy and, if not installed and used in accordance with the instruction, may cause harmful interference to radio communication. However, there is no guarantee that interference will not occur in a particular installation. If this equipment does cause harmful interference to radio or television reception which can be determined by turning the equipment off and on ,the user is encouraged to try to correct interference by one or more of the following measures :

- Reorient or relocate the receiving antenna.
- Increase the separation between the equipment and receiver.
- Connect the equipment into an outlet on circuit different from that to which the receiver is connected.
- Consult the dealer or an experienced radio/TV technician for help.

This device contains licence-exempt transmitter(s)/receiver(s) that comply with innovation, science and Economic development Canada's licence-exempt RSS(s). Operation is subject to the following two conditions : (1) this device may not cause interference, and (2) This device must accept any interference, including interference that may cause undesired operation of the device.

TEMPUS-AG-MV



©2023 The Toro Company
Toro Australia
53 Howards Road, Beverley, SA, 5009

| For more information visit thelandscapestore.com.au | (02) 9161 3939 |



TEMPUS-AG-PR



TEMPUS-AG-PR

Pressure Sensor device 1 Input



INTRODUCTION

The TEMPUS-AG-PR is a sensor device powered by a 9V battery and used only for reading and controlling the pressure of your irrigation system. Thanks to the prewired pressure sensor, the TEMPUS-AG-PR will put the pressure under control and will alert if the thresholds are exceeded. The thresholds can be set from the MyToroTempus application or platform. TEMPUS-AG-PR transmits data via LoRa connection to a TEMPUS-AG-4G/WF gateway.

SPECIFICATION

DIMENSIONS

Width: 10,5 cm

Height: 4,8 cm

Depth: 11,6 cm

FEATURES

Bluetooth® Smart 4.0 Low Energy

LoRa™ radio communication

USE

Operating temperature : -20°C to 50°C

Indoor and outdoor use

Use in humid environment IP68

(test conditions: 1h at 1m depth)

Altitude use up to 2000m

Pollution level 2

Maximum relative humidity of 80% for temperatures up to 31°C and linear decrease up to 50% of relative humidity at 40°C.

Installing the wrong type of battery may cause an explosion or fire hazard.

POWER SUPPLY

9V 6AM6 ou 6LR61 Alkaline battery
(not included)

Current consumption : 0.1mA

Sensor power supply : 5VDC (TBTS)

INSTALLATION

1 Pressure Sensor

Pressure : 0 to 1600 kPa

Screw thread : 1/4" BSP

INSTALLATION GUIDELINES

The TEMPUS-AG-PR is made for an outdoor use. You can place it in a buried valve box or set it on a wall (concrete, brick, cinder blocks) with 2 dowels and 2 countersunk screws of 4X40 not included.

In order to clean the TEMPUS-AG-PR, use soapy water with a sponge and then a soft cloth to wipe it off.

When replacing the sensor, only use a sensor with a waterproof connector (MIPAG1XX004BAAAX).

Step 1

APP DOWNLOAD

1. On your smartphone or tablet, go to the «App Store» or to the «Play Store».



2. Search for «The Toro Company» in the search bar.

Developer
The Toro Company



3. Once found, download the MyToroTempus App



4. Once installed, activate the Bluetooth® of your smartphone or tablet.

CREATE AN ACCOUNT

To use TEMPUS-AG-4G / CT / MS, you need to create your MyToroTempus account.

1. Launch MyToroTempus app from your smartphone and/or tablet.

2. Select the "Registration" button.

3. Follow the steps described on the app.

Note: if you already have an account on the MyToroTempusAG.com platform, you must use the same credentials.

| For more information visit thelandscapestore.com.au | (02) 9161 3939 |

Step 2

ASSOCIATION

1. Unscrew the TEMPUS-AG-PR 's cap
2. Plug the 9V 6LR61 ou 6AM6 battery and screw the cap
3. Sign in with your MyToroTempus account
4. Launch MyToroTempus app from your smartphone or tablet.
5. Click on the «Add a controller» button or on the «+» button
6. Choose the TEMPUS-AG-PR from the available controllers list.
7. To finish your TEMPUS-AG-PR pairing, follow the next steps described in the app.

Note: To identify your TEMPUS-AG-PR among the nearby controllers, please refer to the «Default name» present on its product label.



Security key

The security key allows to protect your controller. You can define it during the step 6 of the «ASSOCIATION» or access to further information by clicking on the icon  at the top right of your screen.

Step 3

PAIRING WITH TEMPUS-AG-4G/WF

To optimize the LoRa™ radio connection between the TEMPUS-AG-4G/WF and the TEMPUS-AG-PR device, we advise to install the TEMPUS-AG-PR under 800 meters to the TEMPUS-AG-4G/WF. We also advise to associate all your Tempus AG device near the TEMPUS-AG-4G/WF before installing them.

1. On the MyToroTempus mobile App, select your TEMPUS-AG-4G/WF and enter pairing mode on the Information screen. (You must be connected via Bluetooth)
2. Select the TEMPUS-AG-PR previously installed.
3. Click on the top right icon  to access to the product's informations.
4. Click on «Remote Access».
5. Select the TEMPUS-AG-4G/WF you want to pair the device with.
6. Click on the button «Send» or  on the bottom of your screen to validate. Once the pairing finished, you can test the connection between your TEMPUS-AG-4G/WF and your TEMPUS-AG-PR
7. Go back to «Remote access» screen.
8. Click on the button  to start the test.

Note:

- The message «Connection established» means that the connection is reliable.
- The message «No connection established» means that it is necessary to bring the TEMPUS-AG-PR closer to the TEMPUS-AG-4G/WF or vice versa.

Step 4

SENSOR INSTALLATION

1. Get closer than 10 meters from TEMPUS-AG-PR and make sure your smartphone's Bluetooth is turned on.
2. Launch MyToroTempus app from your smartphone or tablet.
3. Select the TEMPUS-AG-PR previously installed. (The two devices, smartphone and PR device, must be connected via Bluetooth)
4. Click on "Add a sensor"
5. Select the type of sensor you want connect to your TEMPUS-AG-PR.
6. Select the sensor you want connect to your TEMPUS-AG-PR.
7. To properly connect the wiring and complete the sensor installation, follow the next steps described in the app.



1 input model : analog 0-5 V Pressure Sensor.

Red wires: 5V power supply

The sensor's wires are directly wired to the products at the factory. Only the sensor can be disconnected thanks to its waterproof Metripack-150 connector.

Metripack-150 connector



The sensor used makes it possible to measure the pressure of the irrigation system from 0 to 1600 kPa. It will be installed on the system thanks to its 1/4" BSP screw thread.

DECLARATION OF CONFORMITY

The Toro Company (Toro AG), 1588 N. Marshall Avenue, El Cajon, CA, 92020-1523, USA declare that TEMPUS-AG-CT conform(s) to the following directives, standards and/or other normative documents:

EMC

172376-764709-E: FCC CFR 47 Part 15, Subpart B

Transmissions

HBCS Report # EMC_15028_2 Rev1: LoRa module. The manufacturer declaration 10 Oct 2022, states that LoRa frequencies in use are: 920.2, 920.4, 920.6MHz; RF power less than 20dBm
CFR 47 Part 15, Subpart C (BLE 2,4 GHz)

Safety

IEC 61010-1: 2010 (THIRD EDITION) +A1:2016

IEC 61010-2-030: 2017

CB cert FR_713031

LoRa Module

Microchip RN2903 LoRa™ module 920 MHz HB Compliance Solutions report EMC_15028_2 Rev1 26 May 2016. Covering: FCC title 47 of the CFR Part 51.247 (Digital transmitting device)

GENERAL INFORMATION

 This symbol indicates that the product uses a LoRa™ technology radio.



This symbol indicates that these types of electrical and electronic equipment must be disposed of separately in. Do not dispose of this device with your household waste. Please use the collection and recycling points available in your State when you no longer need this device.



In case of contrary use to the indications given in this user manual, the device protection may be compromised.



This symbol indicates that the product is shock resistant.



This symbol indicates that the product is resistant to ultra violet.



This symbol indicates that the product is waterproof.



This symbol indicates that the supply voltage is a direct voltage.

FCC/IC STATEMENT TEMPUS-AG-PR

This product contains a modular approval with FCC ID : YWW-BLEMOD, T9JRN2903 and IC : 9319A-BLEMOD, 6514A-RN2903.

This device complies with Part 15 of the FCC rules. Operation is subject to the following two conditions : (1) this device may not cause harmful interference, and (2) this device must accept any interference received, including interference that may cause undesired operation.

Caution : the user that changes or modifications not expressly approved by the party responsible for compliance could void the user's authority to operate the equipment.

Note : this equipment has been tested and found to comply with the limits for a Class B digital device , pursuant to part 15 of the FCC Rules. These limits are designed to provide reasonable protection against harmful interference in a residential installation. This equipment generates, uses and can radiate radio frequency energy and, if not installed and used in accordance with the instruction, may cause harmful interference to radio communication. However, there is no guarantee that interference will not occur in a particular installation. If this equipment does cause harmful interference to radio or television reception which can be determined by turning the equipment off and on ,the user is encouraged to try to correct interference by one or more of the following measures :

- Reorient or relocate the receiving antenna.
- Increase the separation between the equipment and receiver.
- Connect the equipment into an outlet on circuit different from that to which the receiver is connected.
- Consult the dealer or an experienced radio/TV technician for help. This device contains licence-exempt transmitter(s)/receiver(s) that comply with innovation, science and Economic development Canada's licence-exempt RSS(s).

Operation is subject to the following two conditions : (1) this device may not cause interference, and (2) This device must accept any interference, including interference that may cause undesired operation of the device.

This device complies with FCC and ISED RF radiation exposure limits set forth for general population. This device must be installed to provide a separation distance of at least 20cm from all persons and must not be co-located or operating in conjunction with any other antenna or transmitter.

TEMPUS-AG-PR



©2023 The Toro Company
Toro Australia
53 Howards Road, Beverley, SA, 5009

| For more information visit thelandscapestore.com.au | (02) 9161 3939 |