

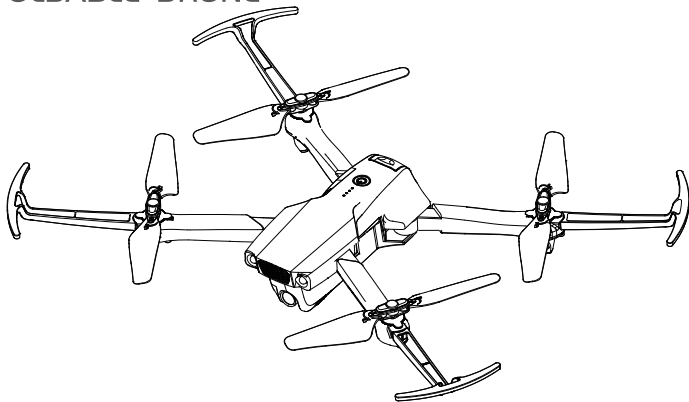

INSTRUCTIONS FOR USE

X500

FOLDABLE DRONE



☎ +1 718-312-0558 (US)
 +44 (0)7723708421 (UK)
 +49 335-4551-9201 (DE)
 ✉ usa@symatoys.com(US)
 eu@symatoys.com (EU)
 🔍 <http://www.symatoys.com>

User Manual

English Manual: Page 1~19 //

Deutsche Anleitung: Seite 20~41 //

Accreditation standard: GB/T26701-2011



1080P HD camera with 250 m
 Long battery life
 (requires a 5G smartphone)



4K 5G WIFI
 Camera



GPS tracking



One key to return



Circle flight



Flight plan



Waypoint flight



Human tracking



Palm control



Optical flow
 positioning



Take-off/landing



Image
 transmission range



Dual-frequency
 technology

Important safety information

Thank you for purchasing this SYMA product. To ensure that you operate the drone correctly, please read these instructions carefully before first use and store them in a safe place for future reference.

Safety Guide

1. Adult or experienced RC pilot's supervision is recommended for children.
2. Non-rechargeable batteries should not be recharged; Batteries should be inserted with a correct polarity; Different types of batteries, new or used batteries should not be mixing.
3. Turn off the drone/transmitter and remove the batteries when not in use.
4. The supply terminals are not be short-circuited
5. Keep away from the rotating blades (rotating blades may cause bodily injuries, or damage to property).
6. Attention: please assemble the drone with the guidance of adults.
7. Do not look directly into the LED lights of the drone as it can damage your eyes.
8. The packing has to be kept since it contains important information.
9. Non-rechargeable batteries are not to be recharged,
10. Rechargeable batteries are to be removed from the toy before being charged,
11. Batteries are only to be charged by adults or by children at least 14 years old.
12. Different types of batteries or new and used batteries are not to be mixed,
13. Batteries are to be inserted with the correct polarity,
14. Exhausted batteries are to be removed from the drone.
15. The supply terminals are not to be short-circuited.
16. Don't use or leave the battery near a heat source such as fire or heater.
17. After flying, don't charge batteries at once to avoid batteries too hot to cause to the fire, make sure it cool down before charging.
18. Don't hit or let batteries fall down when charging to avoid inner short-circuit.
19. Only use the included adaptor for charging. Please replace with new batteries in time if batteries aging.
20. After full charging, please take off adaptor in time, otherwise batteries will discharge and charge again, this way will shorten batteries service life.
21. Remove and insert the battery correctly.

Repair and maintenance

1. Use clean and soft cloth to clean the product.
2. Keep away the product from heat sources.
3. Avoid water exposure to this product. Moisture may cause damages of the aircraft electronic parts.
4. Transformers used with the aircraft should be examined regularly, such as the cord, plug, enclosure and other parts. In case of any damages is found, please stop using it unless it is repaired or replaced.

drone this product

Specifications

Brand Name: SYMA

Model/ITEM NO.: X500

· Drone

Drone weight	205 g (Not included Propeller protector)
Drone Size	360x300x70 mm (Install Propeller protector)
Range	350 m
Altitude	100 m
Image transmission range	300m
Flight time	Hovers indoors for 26-27 minutes
Operating conditions	0°C to 40°C
Video transmission frequency	5 GHz
Motor	8520
Battery	7.6 V 1700 mAh
Charging time	About 3 hours

· Remote control

Operating frequency	2.4 GHz
Range	350 m
Operating conditions	0°C to 40°C
charging time	About 1 hours

· Package contents

Drone	1
Remote control	1
USB charging cable	2
Clockwise/anticlockwise propellers	2
Propeller protectors	4
Instructions	1

Download the SYMA AIR app and watch the video tutorial

Installing the SYMA AIR app

Scan the QR code with your mobile device or download the app from your app store.



iOS



Android(Google play)



Android

* Note: For best results, use a device with iOS 8.0/Android 5.0 or later.

Drone components

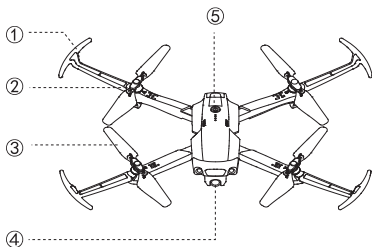

- ① Propeller protector
- ② Motor
- ③ Propeller blades
- ④ Front camera
- ⑤ Power switch

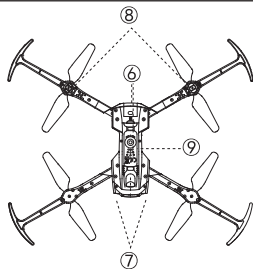

- ⑥ Battery
- ⑦ Front LED indicator
- ⑧ Rear LED indicator
- ⑨ Bottom camera

Remote control

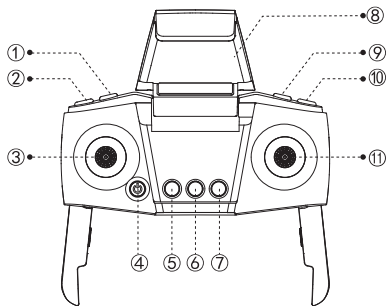

- ① Photo button
- ② Record button
- ③ Left joystick
- ④ Power switch
- ⑤ One-touch take-off/landing
- ⑥ Calibrating the compass
- ⑦ Return to take-off position
- ⑧ phone holder
- ⑨ Lens up
- ⑩ Lens down
- ⑪ Right joystick

Assembling the product

Installing the propellers

Clockwise propellers

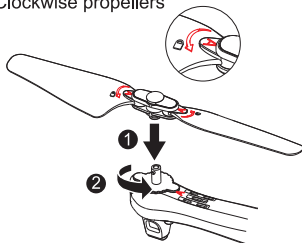

Anticlockwise propellers

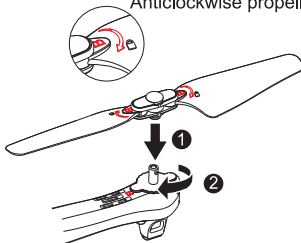

- * Attach the propellers as shown in the diagrams above. Ensure that they are attached in the correct orientation.
 - * Ensure that the clockwise and anticlockwise propellers are attached to the correct arms. The aircraft will not fly correctly if the propellers are attached in the wrong position.
-  *
- * The propellers are made from a delicate material. Exercise caution when attaching them to the aircraft.
 - * Only use propellers that are supplied by the manufacturer.
 - * The propellers are consumable parts. If necessary, purchase replacements from the manufacturer.

Installing the propeller protectors

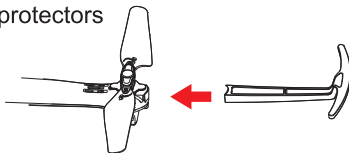

Inserting a memory card (optional accessory)

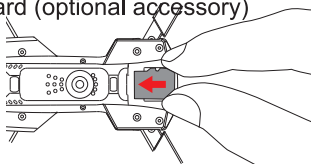

Charging the aircraft battery

Remove the battery

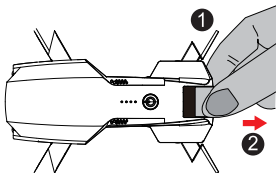

Charge the battery

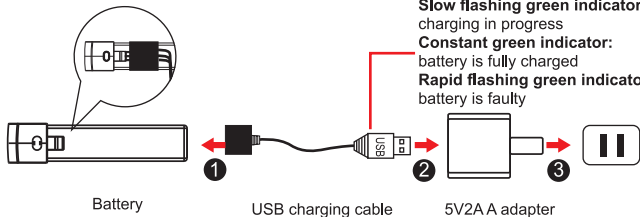

- * Charge the aircraft with the USB charging cable that came with the product.
- * The battery will take longer to charge when you use an adapter with a smaller rated current.

The toy is only to be connected to equipment bearing either of the following symbols:



Maximum radio-frequency power transmitted < 10 dBm. Frequency range: 2409-2475MHz

Insert the battery

- * Ensure that the battery holder clicks into place.

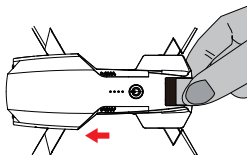

- * Do not short circuit or compress the battery, as this may cause an explosion.
- * Do not disassemble the battery or store it in a hot environment.
- * If you do not plan to use the aircraft for at least 10 days, discharge the battery to 40%-50%. This helps to prolong the lifespan of the battery.
- * Rechargeable batteries should be removed from the drone before being charged.
- * Batteries are only to be charged by adults or by children at least 14 years old.
- * Exhausted batteries should be removed from the aircraft.
- * Caution: Risk of explosion if battery is replaced with ones, Please install the batteries according to the instructions.



Battery warning:

1. Failure to follow all the instructions may result in serious injury, irreparable damage to the battery and may cause a fire, smoke or explosion.
2. Always check the battery's condition before charging or using it.
3. Replace the battery if it has been dropped, or in case of odor, overheating, discolouration, deformation or leakage.
4. Use only the supplied charging cable.
5. The battery temperature must never exceed 60 °C (140 °F) otherwise the battery could be damaged or ignite.
6. Never charge on a flammable surface, near flammable products or inside a vehicle (preferably place the battery in an on-flammable and nonconductive container).
7. Never leave the battery unattended during the charging process. Never disassemble or modify the housing's wiring, or puncture the cells. Always ensure that the charger output voltage corresponds to the voltage of the battery. Do not short circuit the batteries.
8. Never expose the battery to moisture or direct sunlight, or store it in a place where temperatures could exceed 60 °C (drone in the sun, for example)
9. Always keep it out of reach of children.
10. Improper battery use may result in a fire, explosion or other hazard.
11. Non-rechargeable batteries are not to be recharged. Rechargeable batteries are only to be charged under adult supervision.
12. Different types of batteries or new and used batteries are not to be mixed.
13. Batteries are to be inserted with the correct polarity.
14. The supply terminals are not to be short-circuited. Regular examination of transformer or battery charger for any damage to their cord, plug, enclosure and other parts and they must not be used until the damage has been repaired.
15. The packaging has to be kept since it contains important information.

Attaching the phone holder

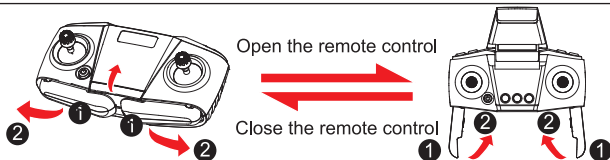

Inserting the remote control batteries

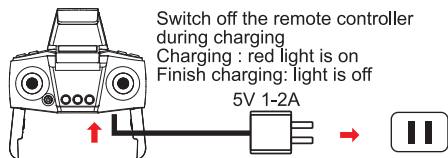

- * When installing the batteries, ensure that you match the + and – ends of the battery with the + and – signs on the controller.
- * During the battery installation, it must be ensured that the polarities of the batteries are matched with that of the battery box. No battery shall be installed with the opposite polarity.
- * Please do not use new and old batteries together.
- * Please do not use different types of batteries together.
- * Do not use rechargeable batteries.

Flight preparation and turning the aircraft on/off

Pairing the remote control with the aircraft

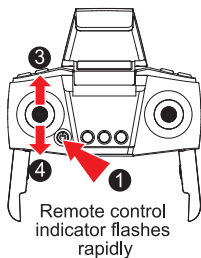

Switch on the remote control Indicator flashes rapidly -> slowly

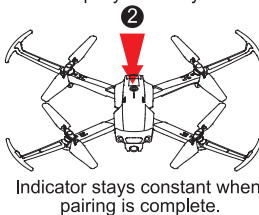

- * When you switch on the remote control, the indicator will flash rapidly for approximately 20 secs to indicate that the remote control is waiting for a signal. The indicator will then flash slowly to indicate that pairing mode has been disabled.

Calibrating the compass

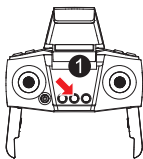

Press the return to home button and move the left joystick to the lower right corner.



Hold the aircraft horizontally and rotate 360 degrees. Indicator flashes slowly -> rapidly

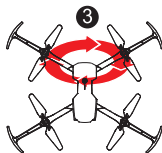

Hold the drone vertically and rotate 360 degrees. Indicator flashes rapidly -> constant



- * Do not calibrate the compass near strong electromagnetic fields or large pieces of metal, e.g. magnetite, car parks or buildings with underground steel reinforcements.
- * When holding the drone horizontally, the angle of inclination must not exceed 30 degrees.

Searching for satellites

The rear indicator will change from orange to green when the aircraft has locked on to a satellite and recorded the take-off location. The drone is now ready to fly.



- * It should take approximately one minute for the aircraft to lock on to a satellite. If the drone fails to find a satellite, recalibrate the compass.
- * Before take-off, place the aircraft in an open space away from obstacles and ensure that GPS mode is enabled.
- * When the rear green indicator flashes rapidly, this indicates that the GPS signal is weak. If this occurs, land the drone manually and restart the satellite search.

Turning the drone on

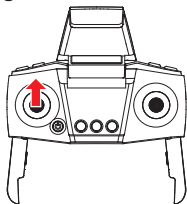

Move the left joystick upwards or

or

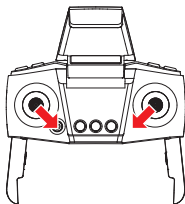

Push the left and right joysticks downwards in a V shape for 1 second.

Turning the drone off

Method one

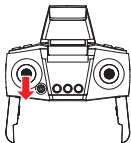

Push the left joystick downwards for 2-3 seconds.

Method two

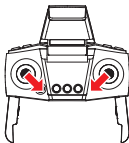

Push the left and right joysticks downwards in a V shape for 2 seconds.

Method three



Press the take-off/landing button to make the drone land automatically and switch off.



* The drone will switch off automatically if its angle of inclination exceeds 90 degrees.

Using the remote control

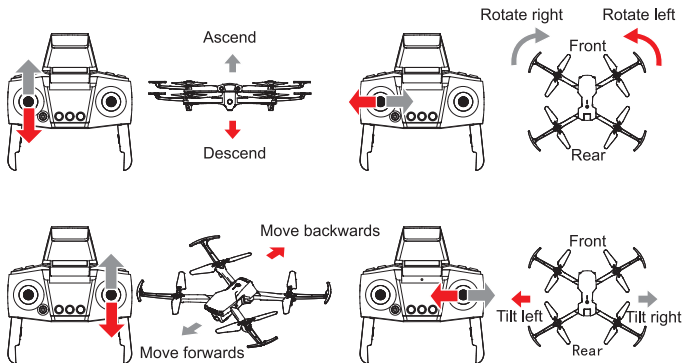

Flight modes



Optical flow positioning

Front indicator is constant white, rear indicator is constant yellow.



- * If the rear indicator starts to flash rapidly, this indicates that the optical signal is weak and the drone cannot determine its position.
- * Performance may be impaired in dark surroundings, areas with reflective surfaces (e.g. water), or at altitudes of more than 6 m.
- * Optical flow positioning only supports altitudes of less than 6 m.

GPS



GPS mode

Front indicator is constant white, rear indicator is constant green.



- * When the battery level is normal, the drone can fly to a distance of 350 m at a maximum altitude of 100 m.
- * When the battery level is low, the drone can fly to a distance of 20 m at a maximum altitude of 20 m.
- * If the rear indicator starts to flash rapidly, this indicates that the GPS signal is weak and the drone cannot determine its position.
- * GPS mode cannot be used indoors.



Headless mode

The indicator on the drone will flash once every 4 seconds.

1. Configuring the forwards direction

When you switch on the drone for the first time, the direction in which the front side of the drone is pointing will be set as the forwards direction.

2. Enabling headless mode

① After pairing the remote control with the drone, hold down the right joystick for approximately 3 seconds. The remote control will beep 8 times to indicate that headless mode is enabled. To disable headless mode, hold down the right joystick again for approximately 3 seconds.

② In headless mode, you do not need to determine the drone orientation. You can move the joysticks on the remote control to make the aircraft move in the corresponding direction.

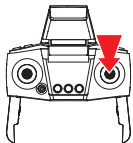

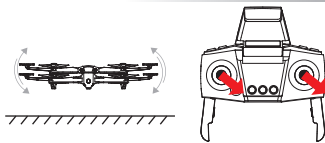

Level calibration

* The drone cannot be calibrated if the angle of inclination is greater than 10 degrees.

Place the drone on a level surface and move the left and right joysticks to the lower right corner for approximately 3 seconds. The indicator will flash rapidly and then stay constant to indicate that the calibration process is complete.

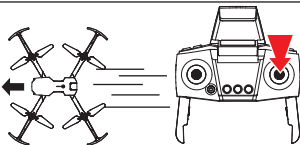

High/low speed mode

Briefly press the right joystick to switch between high and low speed mode.

1. Low speed mode is enabled by default when the drone is switched on.
2. The remote control beeps twice when high speed mode is enabled and once when low speed mode is enabled.

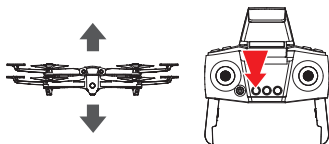

One-touch take-off/landing

1. When the drone is under standby mode, Press the take-off/landing button to make the drone take off automatically and hover at a height of 1.5 m.
2. When the drone is under active mode, it will automatically land on ground if you press the one key landing

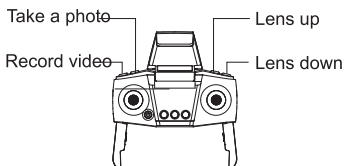

Taking a photo or video recording with the remote control

1. Take a photo: Press the photo button. The indicator on the drone will flash to indicate that a photo was taken.
2. Record video: Press the record button. The indicator on the drone will flash twice to indicate that recording is in progress. Press the record button again to end the recording. The indicator on the drone will turn on to indicate that recording is complete.





Photo button



Record button

Taking a photo or video recording with hand gestures

1. Take a photo: Position your hand approximately 1.5 m away from the front lens and hold the  hand gesture for 3 seconds.
2. Record video: Position your hand approximately 1.5m away from the front lens and hold the  hand gesture for 3 seconds.



- * Photo and video recording gestures cannot be used when the bottom camera is enabled.
- * The camera may accidentally take a photo or start a video recording if there are surrounding objects that resemble the or gestures.
- * If there is no memory card in the aircraft, photos and video recordings will be saved to your phone.
- * If there is a memory card inserted in the drone, photos and video recordings will be saved to the memory card and your phone.
- * The aircraft supports memory cards with a capacity of up to 64 GB.

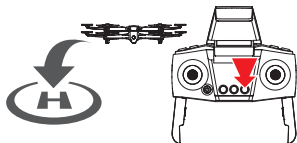

Return to home function

In GPS mode (when the indicator is constant), hold down the return to home button to automatically return the aircraft to its take-off position. During the return flight, you can use the joystick controls to make the aircraft ascend, descend and move left/right in order to avoid obstacles. To terminate the return flight, hold down the return to home button.

- * If the drone is flying at an altitude of less than 20 m, it will automatically ascend to an altitude of 20 m before returning home.
- * If the drone is flying at an altitude of more than 20 m, it will return home at the same altitude.

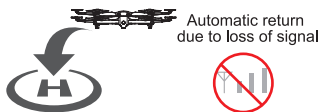

No signal

If the remote control signal is lost for more than 10 seconds, the drone will automatically return to the take-off position. If the signal is restored during the return flight, you can hold down the return to home button to terminate the return flight.

- * The drone cannot automatically avoid obstacles during the return flight.
- * The automatic return to home function is not available when the GPS signal is weak (flashing indicator).
- * If the drone does not receive a GPS signal and loses contact with the remote control for more than 6 seconds, it will not be able to return to home and land automatically.

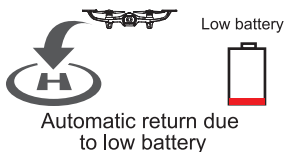

When the drone battery is low, the drone will automatically return to the take-off position. During the return flight, you can use the joystick controls to make the drone ascend, descend and move left/right in order to avoid obstacles.

- * If the drone is further than 20 m from the landing position, the return flight cannot be terminated.
- * If the drone is less than 20 m from the landing position, the return flight can be terminated.

Landing position: The initial unlock/take-off position.

Smart app features

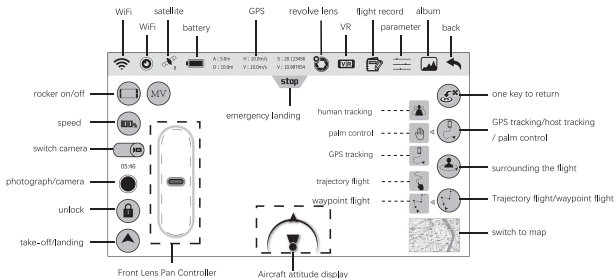

GPS tracking



One key to return



Circle flight



Flight plan



Waypoint flight



Human tracking



Palm control



Optical flow positioning



Take-off/landing



MV Features

- * Before using the smart app features, watch the video tutorial in the SYMA AIR app or on the SYMA website.
- * Ensure that you pre-configure the flight altitude and distance in the SYMA AIR app.

Understanding the aircraft LED indicators

No.	Indicator status	Meaning
1	Front indicator = constant white, rear indicator = constant yellow	Optical flow positioning
2	Front indicator = constant white, rear indicator = constant green	GPS mode
3	Front and rear indicators flash once every 4 seconds	Headless mode
4	Front and rear indicators flash twice every 1.5 seconds	Recording in progress
5	Front and rear indicators flash rapidly	Pairing or level calibration in progress
6	Front and rear indicators flash twice every second	Low battery
7	Front and rear indicators flash once every second	Signal lost
8	Front indicator = constant, rear indicator = flashing slowly	GPS fault
9	Front indicator = constant, rear indicator = flashing rapidly	Poor GPS reception

Troubleshooting

Problem	Cause	Cause Solution
The drone does not respond.	<ol style="list-style-type: none"> 1. Undervoltage protection was enabled. 2. The remote control battery level is low and the power indicator is flashing. 	<ol style="list-style-type: none"> 1. Charge the drone battery. 2. Change the batteries in the remote control.
The drone's response is intermittent.	<ol style="list-style-type: none"> 1. The remote control batteries are nearly empty. 2. There is interference from a remote control on the same frequency. 	<ol style="list-style-type: none"> 1. Change the batteries. 2. Move to a different area where there is no interference.
The drone drifts to one side whilst hovering.	The drone is not calibrated level to the ground.	Calibrate the drone.
The drone does not travel in a forwards direction in headless mode.	The drone was involved in a collision.	Reconfigure the forwards direction.
The drone does not hover properly/the aircraft keeps moving up and down.	<ol style="list-style-type: none"> 1. The drone not calibrated level to the ground. 2. The air pressure is unstable due to poor weather conditions. 3. A violent collision corrupted the gyroscope's data. 	<ol style="list-style-type: none"> 1. Calibrate the drone. 2. Avoid flying in poor weather. 3. Calibrate the drone.

Accessories (available separately)

The following section contains a list of optional accessories that are available to purchase. Accessories can be purchased from your local retailer. Please indicate your preferred colour when making your purchase.



Drone body



Main unit battery cover



Arm



Arm parts



Propeller blades

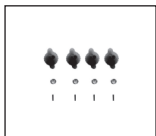

Propeller parts

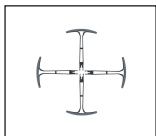

Propeller protector



Feet

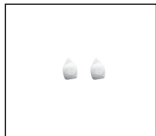

Light cover

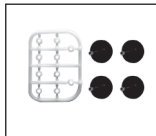

gear

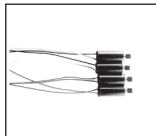

Motor

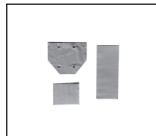

Protective cover



Lights



GPS module



Receiver board

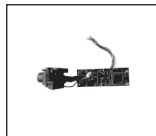

Camera circuit board

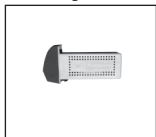

Battery



Charging cable



Remote control
Charging cable



Remote control

Warning: Changes or modifications to this unit not expressly approved by the party responsible for compliance could void the user's authority to operate the equipment.

NOTE: This equipment has been tested and found to comply with the limits for a Class B digital device, pursuant to Part 15 of the FCC Rules. These limits are designed to provide reasonable protection against harmful interference in a residential installation. This equipment generates, uses and can radiate radio frequency energy and, if not installed and used in accordance with the instructions, may cause harmful interference to radio communications. However, there is no guarantee that interference will not occur in a particular installation. If this equipment does cause harmful interference to radio or television reception, which can be determined by turning the equipment off and on, the user is encouraged to try to correct the interference by one or more of the following measures:

- Reorient or relocate the receiving antenna.
- Increase the separation between the equipment and receiver.
- Connect the equipment into an outlet on a circuit different from that to which the receiver is connected.
- Consult the dealer or an experienced radio/TV technician for help.

"This device complies with FCC radiation exposure limits set forth for general population (uncontrolled exposure). This device must not be collocated or operating in conjunction with any other antenna or transmitter."

RF frequency band :2409-2475MHZ

Transmitter power : -3.73dBm (Max.)

product name: [DRONE]

model number: [X500]

Brand name :SYMA

Declaration of Conformity Inserts:

Hereby , Guangdong SYMA Model Aircraft Industrial Co., Ltd. declares that the radio equipment type drone is in compliance with Directive 2014/53/EU. The full text of the EU declaration of conformity is available at the following internet address:

http: //www.symatoys.com/down/declaration-of-conformityhtml

European Representative:
CET PRODUCT SERVICE LTD.
Osterholzallee 144
71636 Ludwigsburg Germany
Phone: +4971416432236
Email: info.cetservice@gmail.com

British Representative:
CET PRODUCT SERVICE LTD.
Chase Business Centre, 39-41 Chase Side,
London N14 5BP United Kingdom
E-mail: info.cetservice@gmail.com Tel: +447419325266

United States Representative:
Duvin Trade Inc
5800 Wood Sorrel Dr, Littleton, Co, 80123, United States
Phone: 718-312-0558
E-mail: amz@symatoys.com

SYMA is a trademark of Guangdong Syma Model Aircraft Industrial Co., Ltd.
registered in the United States and/or other countries

Manufacturer:
Guangdong SYMA Model Aircraft Industrial Co., Ltd.
Address: No.2 West Xingye Road, intersection of North Xingye Road,
Laimei Industrial Park, Chenghai District, Shantou City,
Guangdong Province, China,
Postal Code: 515800

Contact Us

Please do not hesitate to contact us if you need more further support

✉ warranty@symatoys.com.cn
☎ +1 718-312-0558(US)
+44 (0)7723708421(UK)
+4933545519201(DE)



For online support, please scan this
code with Facebook Messenger



The company has the right of final interpretation of this user manual.

WARRANTY



LIMITED **2-YEAR** WARRANTY AND FREE LIMITED REPLACEMENT PARTS FOR **2 YEARS**

Symatoys.com.cn warrants to the original buyer only that its products will be free from defects in material and workmanship for 2 years from the date upon which the product is shipped, either directly from symatoys.com.cn or from an Authorized Re-seller's location, to the buyer.

The following condition's must to be eligible for warranty coverage:

1. During the warranty period product is used as intended by the manufacturer.
2. The Product has not been disassembled or modified.
3. The labels and serial numbers show no signs of tampering or altering.
- 4. Buyer has a warranty code obtained by registering their product online prior to making a claim.**

EXCEPTIONS: THE LIMITED WARRANTY SHALL NOT APPLY TO:

- Damage caused by normal wear and tear
- Accident, negligence, abuse, misuse, misapplication or willful damage by buyer (or its agents), or acts of nature
- Crash or burning caused by non-manufacturing factors
- Damage caused by authorized modification or disassembly not authorized by the instruction manual
- Damage, caused by incorrect use or operation
- Damage caused by mismatch or misuse of battery or charger
- Failure of the operator to follow the operating instruction or use outside the products operating parameters
- Damage caused by operating the product in or around electromagnetic interference (i.e., radio transmitting tower, high-voltage wire, substation, etc.)
- Damage caused by operating the product where there may be interference caused by other wireless devices
- Operating the product with load capacity in excess of the sale weight listed in the manual
- Operating the product with aged, damaged or unauthenticated third-party components
- Operating the product with a defective battery

WARRANTY

PROCEDURE: Any claims for breach of the foregoing limited warranty shall only be valid if buyer makes such claim in writing within 2 year of the date of shipment of the product to which the claim. To make a warranty claim, please email warranty@symatoys.com.cn with your full name, address, phone number, order number, vehicle type, part type and purchase date and product issue.

LIMITED REMEDY: Symatoys.com.cn's sole liability, and buyer's sole remedy for any breach of the foregoing warranty shall be at symatoys.com.cn's option to exchange the product with a new product or a refurbished product that is functionally equivalent to the original product, or issue a credit or refund to the purchase price the product. Any replaced products shall be warranted as set forth herein, provided that the period within which buyer may make further claims shall be limited to the remainder of the original period for the applicable product or 2 years, whichever is longer (although the warranty period shall be suspended during any period of replacement)

DISCLAIMER: THE WARRANTY AND REMEDIES ARE EXCLUSIVE AND IN LIEU OF ALL OTHER WARRANTIES. AND Symatoys.com.cn DISCLAIMS ALL OTHER WARRANTIES, EXPRESS OR IMPLIED, INCLUDING WITHOUT LIMITATION THE IMPLIED WARRANTIES OF MERCHANTABILITY AND FITNESS FOR A PARTICULAR PURPOSE, NON-INFRINGEMENT AND ANY WARRANTIES ARISING OUT OF COURSE OF DEALING, COURSE OF PERFORMANCE AND TRADE USAGE.

Symatoys.com.cn IS NOT RESPONSIBLE FOR DIRECT, SPECIAL, INCIDENTAL OR CONSEQUENTIAL DAMAGES RESULTING FROM ANY BREACH OF WARRANTY OR CONDITION, OR UNDER ANY OTHER LEGAL THEORY, INCLUDING BUT NOT LIMITED TO LOSS OF USE; LOSS OF REVENUE; LOSS OF ACTUAL ANTICIPATED PROFITS (INCLUDING LOSS OF PROFITS ON CONTRACTS); LOSS OF THE USE OF MONEY, LOSS OF ANTICIPATED SAVINGS; LOSS OF BUSINESS COSS OF OPPORTUNITY; LOSS OF GOODWILL, LOSS OF EPUTATION; LOSS OF DAMAGE TO COMPROMISE OR CORRUPTION OF DATA; OR ANY INDIRECT OR CONSEQUENTIAL LOSS OR DAMAGE HOWSOEVER CAUSED INCLUDING THE REPLACEMENT OF EQUIPMENT AND PROPERTY.

ANY COSTS OF RECOVERING OR REPRODUCING ANY DATA STORED IN OR USED WITH THE PRODUCT OR ANY FAILURE TO MAINTAIN THE CONFIDENTIALITY OF INFORMATION STORED THE PRODUCT.

Some states do not allow the exclusion or limitation of incidental or consequential damages. so the above limitation or exclusion may not apply to you. In addition, some states do not allow limitations on how long an implied warranty lasts, so the above limitation may not apply to you.

FREE REPLACEMENT PARTS FOR 2 YEARS:

Symatoys.com.cn shall also make available any spare part needed for registered vehicles free of charge for 2 years from the date of purchase, with the exception of batteries, motors, circuit boards and transmitters. Shipping charges may apply Limit one part type request per registered vehicle (e.g., registrants are entitled to one extra set of batteries per registered vehicle). To request spare parts, please email warranty@symatoys.com.cn with your warranty code, vehicle name/model, current shipping address, purchase date and part type

GET YOUR WARRANTY CODE AT symatoys.com.cn/pages/warranty-signup

HAVE YOUR ORDER NUMBER AND/OR VEHICLE UPC READY