



Initial location with 3M tape, then secure with screws.

## Features



- Sourced by high output SMD5050, good color conformity and no spot.
- 99.99% gold thread, pure copper bracket coated with silver.
- SDCM≤5 each BIN.
- Special lens design, 160°beaming angle with even light.
- Overmoulded: anti-dusting, anti-moisture, waterproof, anti-shock.
- 20 pcs Max. in a series connection.
- CE, ROHS and UL certified.

## Application



- Best for 8-15 cm depth signs at airports, metros, banks, buildings and shopping malls, etc.

## Parameters >

Items	Parameters
Part Number	ZH03QA5-Q
CCT ( K )	RGB
Beaming Angle ( ° )	160
CRI ( Ra )	≥75
Luminous Flux ( lm )	20
Voltage ( V )	DC12
Power ( W )	0.65
Driving Method	Constant Voltage
Dimension ( mm )	85*17.5*8.4
Weight ( g )	9.57
Working Tem. ( °C )	-25 ~ +60
Storage Tem. ( °C )	-25 ~ +70
Protection Grade	IP65

## Dimension >

Unit:mm

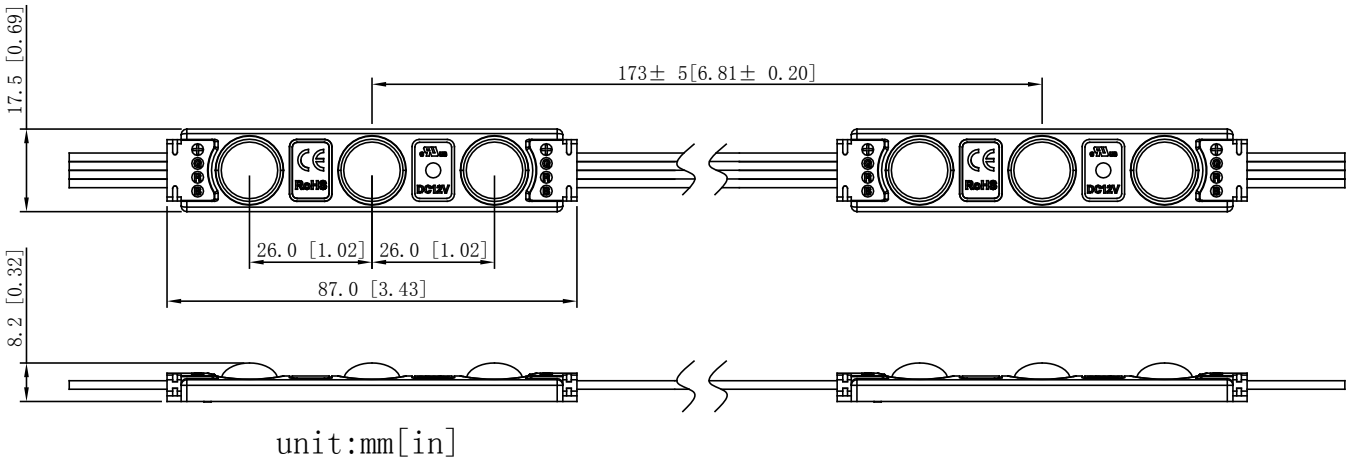

Beaming Angle >

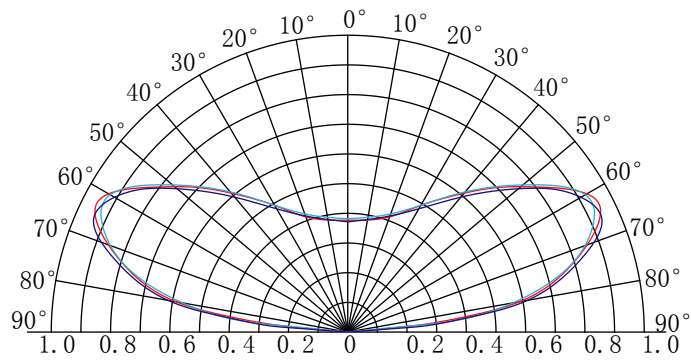

Reference Scheme >

Depth(mm)	Distance(mm)	Density(pcs/m <sup>2</sup> )	Illumination(lux)
Dz=60	Dx=100 Dy=50	200	
Dz=80	Dx=120 Dy=70	119	
Dz=100	Dx=140 Dy=90	79	
Dz=120	Dx=160 Dy=110	57	
Dz=150	Dx=190 Dy=130	40	

Remark:

- The acrylic plate in the case is 3mm thickness, and the light transmittance is 54.4%.
- The illumination above is the minimum data when evenly lighted.
- The above data is for reference only.

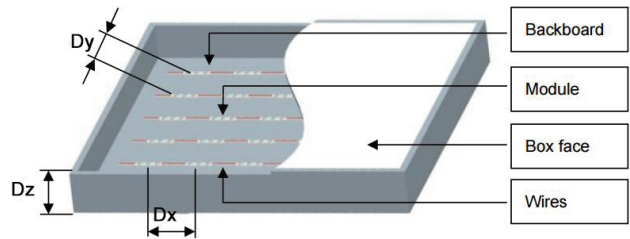

Wire Connection >

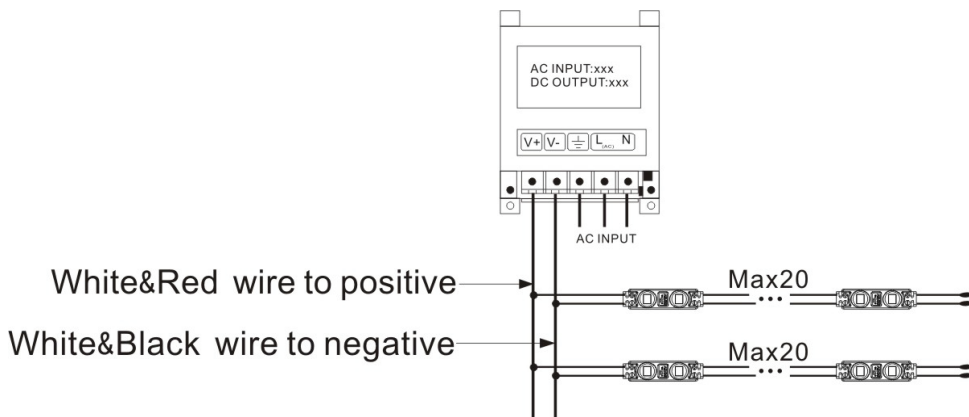

## Packing

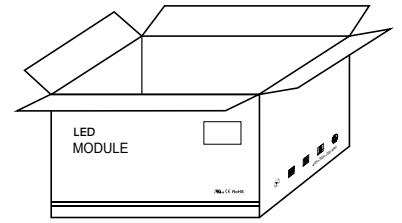
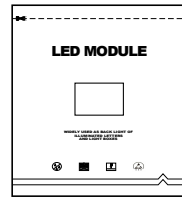
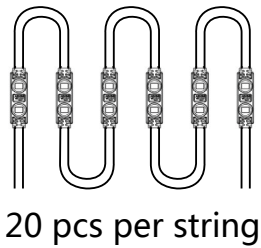

## Packing Specification

- Antistatic bag adopted
- Packing information

Part Number	ZH03QA5-Q
Carton dimension(mm)	490*450*220
Bags per carton	10
Quantity per carton(pcs)	1000
Net Weight(kg)	13.8(1±10%)
Gross Weight(kg)	15.1(1±10%)

- Due to the packing manner difference, please adhere to the original products in case of discrepancy found between the picture and actual product.

## Warning

- Disassembling or modifying the product is forbidden.
- Installation with power on is forbidden.
- Any organic solvent chemical is forbidden.
- Acidic or alkaline adhesive is forbidden when install, neutral glass cement could be used for installation purpose, make it drying in open environment for four hours.
- Isolation and corrosion prevention on all wiring points and wire ends.
- Make sure the power wire is thick enough and ensure the voltage and connections are connected correctly before power on.
- This product should be used in a sign, do not expose it in opening site.
- Installation, maintaining should be done by professional staff.
- 20 pcs in a serial connection maximum.
- The power wire between power supply and module should be less than two meters to keep the same brightness on all parts.
- Initial location with 3M tape, then secure with screws.

## Declaration



- Warranty: 5 years.
- In order to ensure the safety, the broken wires need to be replaced by the manufacturer or the service agent, or by the staff with the similar qualification.
- The given data in the specification was based on the laboratory testing, there may be discrepancy found in the actual products.
- The given drawings in the specification are only for reference, there may be discrepancy found in the actual products.
- The products are subject to change without prior notification.



**RoHS**

**Company Address:**

Rm. WS, 9F, LuBan Building, Hongli West Road, Futian District, Shenzhen, China 518034

**Factory Address:**

No. B, Xinyongfeng Industrial Area, Yingrenshi Village, Shiyuan Town, Bao'an District, Shenzhen, China 518000

**TEL:** +86-755-83544570

**FAX:** +86-755-83056229

**Website:** [www.lbyled.com](http://www.lbyled.com)

**E-mail:** [info@lbyled.com](mailto:info@lbyled.com)



**LBY LED®**  
signs never been so easy