

# S-5!<sup>®</sup>

## The Right Way!

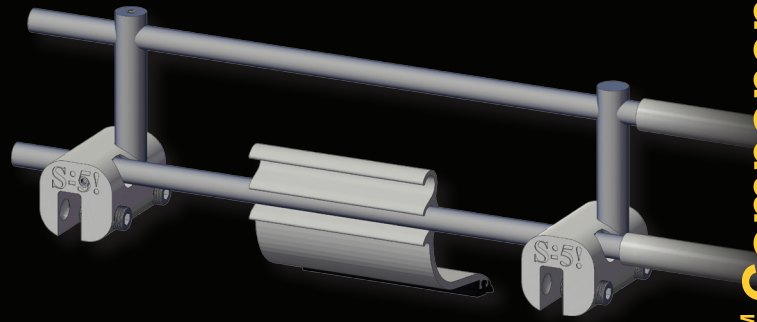

### SnoRail™ and SnoFence™ – Aluminum

The SnoRail™ and SnoFence™ systems are available in brass for use on copper batten or standing seam roofs and in aluminum for other standing seam roofing materials.

#### S-5-ASF Clamp

These clamps are designed to fit either vertical or horizontal (rotating 90°) seam profiles having a finished seam (thickness) dimension of .40" or less. The clamp is specially designed for versatility on a variety of standing panel seams and profiles—both architectural and structural. All components come with required hardware.

#### S-5-AE Clamp and SnoPost E™

The S-5-AE clamp and SnoPost E™ are used at the rate of one per 48' of assembly, and at the ends of the assembly to "fix" the SnoRod™, preventing lateral movement.

#### SnoPost™

The stainless steel SnoPost™, when threaded into the clamp, provides for the addition of a second SnoRod about 2" above the first.

#### SnoRod™ (not included)

The stainless steel SnoRod is inserted through the S-5-ASF clamps, placing it just above the panel seams. Add a second SnoRod through SnoPosts for a SnoFence system.

#### SnoRod™ Coupling

The coupling assures end-to-end rod alignment and continuity.

#### SnoClip™

SnoClip™ can be added to retard the migration of snow and ice beneath the SnoRod. See the SnoClip cutsheet for more details.



S-5-ASF

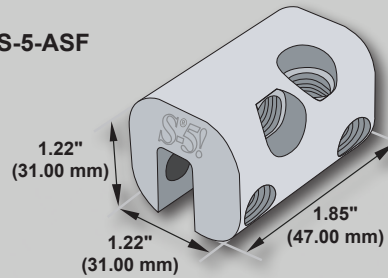

S-5-AE

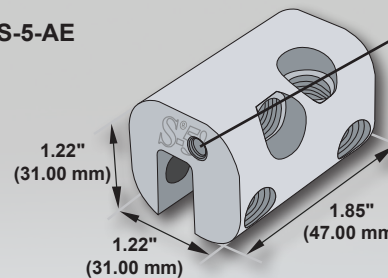

8-32 Setscrew locks SnoRod into place.

SnoPost E

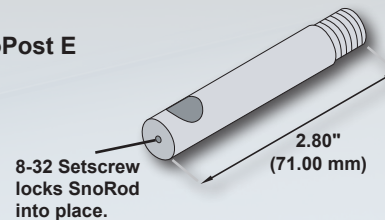

8-32 Setscrew locks SnoRod into place.

SnoPost

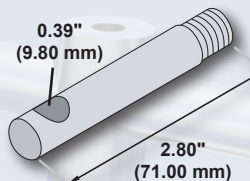

SnoRod

0.38" (9.50 mm)



Aluminum Coupling

3.00" (76.20 mm)

Please note: Images are not to scale. All measurements are rounded to the second decimal place.

The right way to attach almost anything to metal roofs!

SnoRail™ & SnoFence™ Components

888-825-3432 | www.S-5.com



Whether aluminum or brass, our SnoRail™ and SnoFence™ system offers a sleek, stylish design. Utilizing patented S-5!® clamping technology, this snow retention system doesn't pierce the metal roofing, thereby protecting roof coatings and weather-tightness warranties.

## SnoRail™ and SnoFence™ – Brass

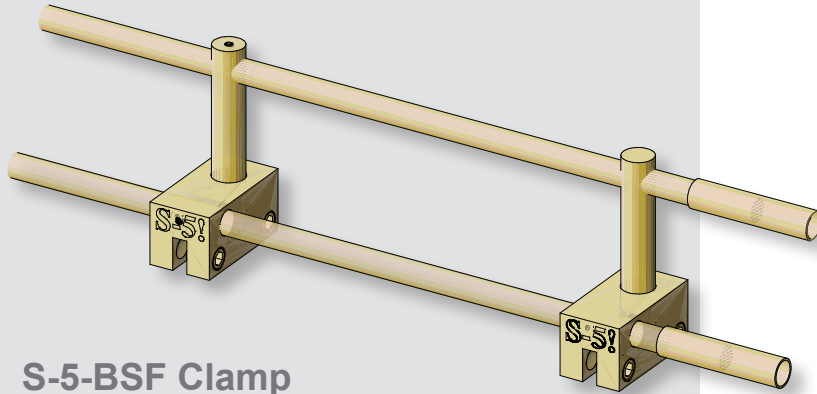

### S-5-BSF Clamp

These brass clamps are designed to fit traditional double folded horizontal and batten seam profiles having a finished seam (thickness) dimension of .25" or less. All components come with required hardware.

### S-5-BE Clamp and SnoPost BE™

The S-5-BE and SnoPost BE™ are used at the rate of one per 50' of assembly, and at the ends of the assembly to "fix" the SnoRod™, preventing lateral movement.

### SnoPost™ B

The SnoPost™ - Brass, when threaded into the clamp, provides for the addition of a second SnoRod about 2" above the first.

### SnoRod™ B (not included)

The SnoRod - Brass is inserted through the S-5-BSF clamps, placing it just above the panel seams. Add a second SnoRod through SnoPosts for a SnoFence™ system.

### Brass Coupling

The coupling assures end-to-end rod alignment and continuity.

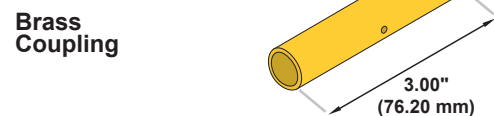
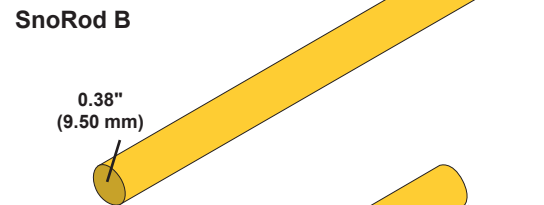
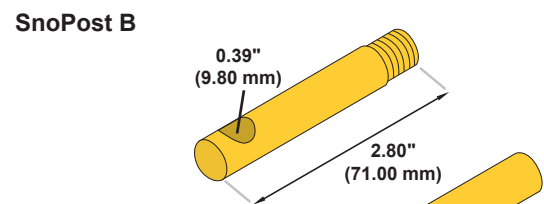
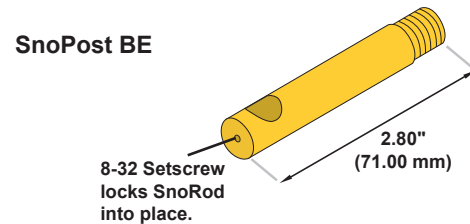
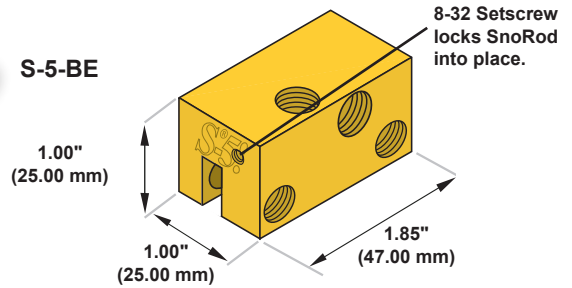
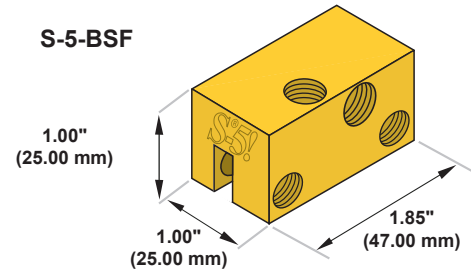

Please note: Images are not to scale. All measurements are rounded to the second decimal place.

#### S-5!® Warning! Please use this product responsibly!

Products are protected by multiple U.S. and foreign patents. Visit the website at [www.S-5.com](http://www.S-5.com) for complete information on patents and trademarks. For maximum holding strength, setscrews should be tensioned and re-tensioned as the seam material compresses. Clamp setscrew tension should be verified using a calibrated torque wrench between 160 and 180 inch pounds when used on 22ga steel, and between 130 and 150 inch pounds for all other metals and thinner gauges of steel. Consult the S-5! website at [www.S-5.com](http://www.S-5.com) for published data regarding holding strength.

Copyright 2012, Metal Roof Innovations, Ltd. S-5! products are patented protected. S-5! aggressively protects its patents, trademarks and copyrights. Version 102212.

Distributed by