

S-5![®]

The Right Way!

S-5-H90 Clamp

The S-5-H90 is a one-piece clamp that was developed to securely and cost-effectively accommodate metal roof panels with a horizontal seam greater than 0.65".

Turning the clamp 90 degrees so that the bolt hole side is facing up, slip the clamp on the seam and tighten the setscrews. Go to www.S-5.com/tools for information about properly attaching S-5![®] clamps.

After the clamp is installed, affix ancillary items using either of the two threaded bolt holes and bolt provided. The S-5-H90 is perfect for use with S-5! ColorGard[®] and X-Gard[™] snow retention systems and other heavy-duty applications.

S-5-H90 Mini Clamp

The S-5-H90 Mini is a bit shorter than the S-5-H90 and has one setscrew and one threaded bolt hole rather than two. The mini is the choice for attaching all kinds of rooftop accessories: signs, walkways, satellite dishes, antennas, rooftop lighting, lightning protection systems, solar arrays, exhaust stack bracing, conduit, condensate lines, mechanical equipment—just about anything!*

*S-5! mini clamps are not compatible with, and should not be used with, S-5! SnoRail[™]/SnoFence[™] or ColorGard[®] snow retention systems.

1

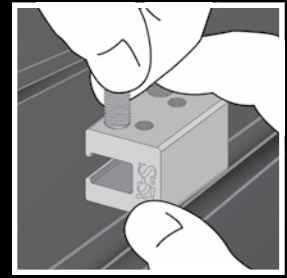

2

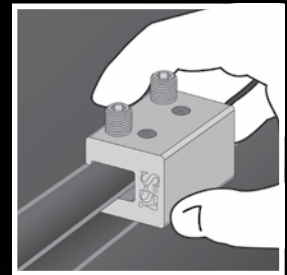

3

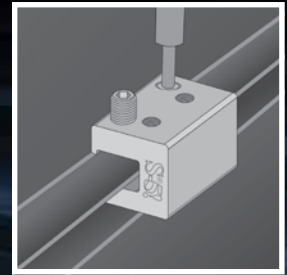

The one-piece S-5-H90 clamp was developed to fit standing seam panels with horizontal seams.

S-5-H90 and S-5-H90 Mini



888-825-3432 | www.S-5.com

The right way to attach almost anything to metal roofs!

S-5![®]

The Right Way!

The strength of the S-5-H90 clamp is in its simple design. The patented setscrews will slightly dimple the metal seam material but will not puncture it—leaving roof manufacturers' warranties intact.

The **S-5-H90 and S-5-H90 Mini clamps** are each furnished with the hardware shown to the right. Each box also includes a bit tip for tightening setscrews using an electric screw gun. The structural aluminum attachment clamp is compatible with all common metal roofing materials excluding copper. All necessary stainless steel hardware is included. Please visit www.S-5.com for more information including CAD details, metallurgical compatibilities, and specifications.

The S-5-H90 clamp has been tested for load-to-failure results on a variety of horizontal standing seam roof profiles from leading panel manufacturers. The independent lab test reports found on our website at www.S-5.com prove that S-5![®] holding strength is unmatched in the industry.

Example Profiles

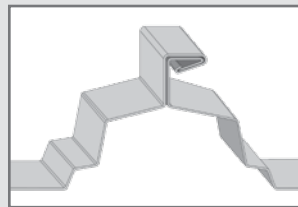
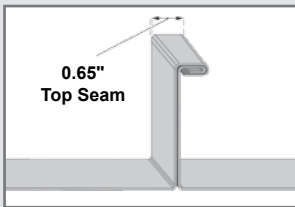

S-5-H90

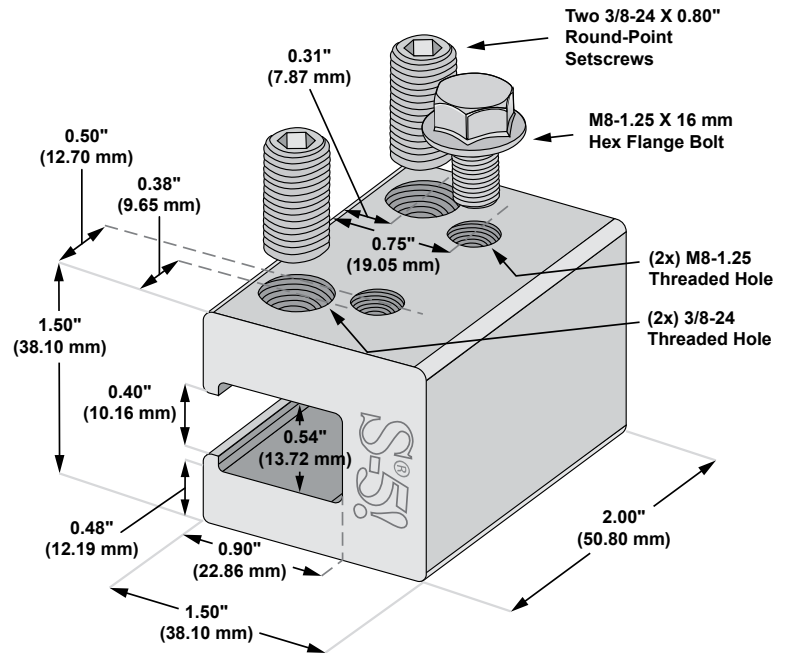

S-5-H90 Mini

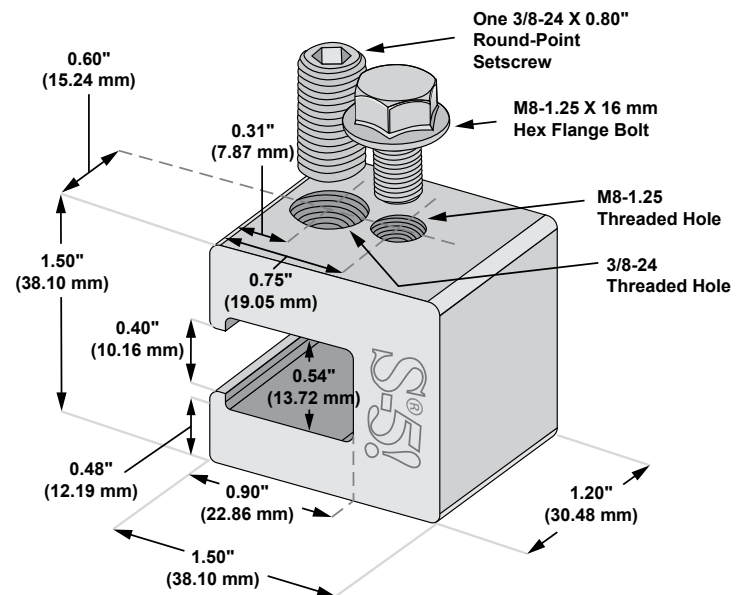

S-5![®] Warning! Please use this product responsibly!

Products are protected by multiple U.S. and foreign patents. Visit the website at www.S-5.com for complete information on patents and trademarks. Consult the S-5! website at www.S-5.com for published data regarding installation instructions and holding strength.

Copyright 2015, Metal Roof Innovations, Ltd. S-5! products are patent protected. S-5! aggressively protects its patents, trademarks, and copyrights. Version 052115.

Distributed by