

Alsipercha Fall Protection

The ALSIPERCHA and related equipment is designed to provide portable fall protection for workers subjected to fall hazards during leading edge construction.

A safety system, especially useful for PERIMETERS. The system provides fall protection while installing: boards, safety handrails, gallows-type safety nets, form work risers and all activities involved in form work assembly where there is risk of falling from a height. Easy to assemble and use, does not require external installers.

Features of the System

- Allows the operator to work safely covering an area of 1345.49 ft.² and move within a radius of 18 ft. around the vertical boom.
- Inverted "L" shaped metal structure measuring 8'-2" long and 14'-1" high (11'-5" when attached to the column).
- Metal structure weighing 177 lbs. made of high quality steel.
- Housing steel tube of 3' height.
- To be handled by crane.
- With a wide range of accessories for use in any building site situation, providing safety at all times.
- The system has been designed for columns spaced at up to 26' (8 m) intervals.

ANSI/CSA

Engineered according to ANSI Z359.6 and CSA Z259.1 standards.

Assembly, Use and
Safety Instruction
Manual



<http://www.tiedown.com/pdf/e1637.pdf>

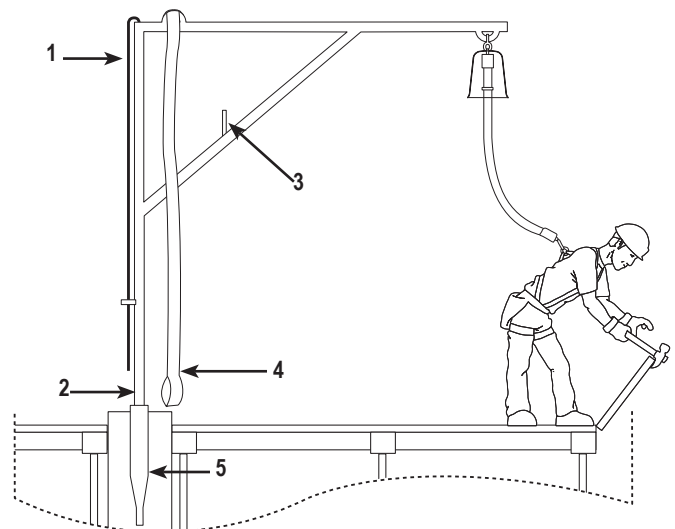

- 1 ~ Hook #13896 (accessory for changing the anchor point)
- 2 ~ Alsipercha Body #13891 (main body that turns 360°)
- 3 ~ Pivot Point (used to anchor the hook)
- 4 ~ Sling #13910 (used to move the assembly with a crane)
- 5 ~ Conical Tube #13890 (case into the concrete column)

See reverse side for
additional specifications



E1636 Rev. 2/26/20

Alsipercha Part Descriptions

ALSIPERCHA - "L" FRAME

Three components are required to properly use the Alsipercha "L" frame fall arrest device.

| | |
|--------------------|-----------------------|
| "L" Frame Assembly | Part ID: 13891 |
| Hook | Part ID: 13896 |
| Sling | Part ID: 13910 |

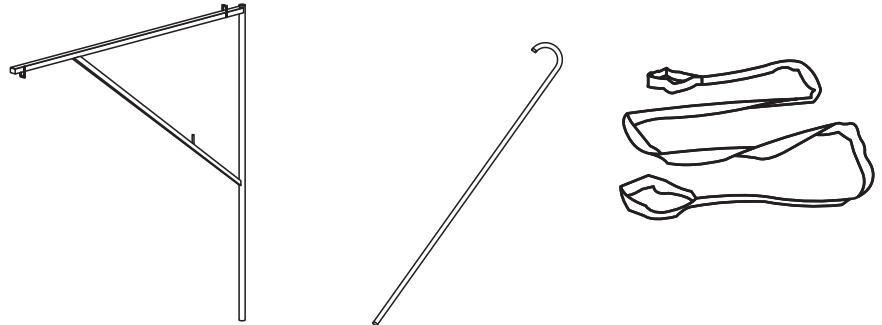

ALSIPERCHA - CONICAL CONE

Three components are required to properly use the Alsipercha Conical Cone Frame attachment.

| | |
|---------------------|-----------------------|
| Column Clamp (x2) | Part ID: 13893 |
| Column Clamp Sleeve | Part ID: 13894 |

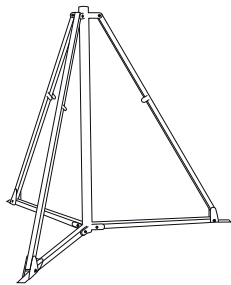
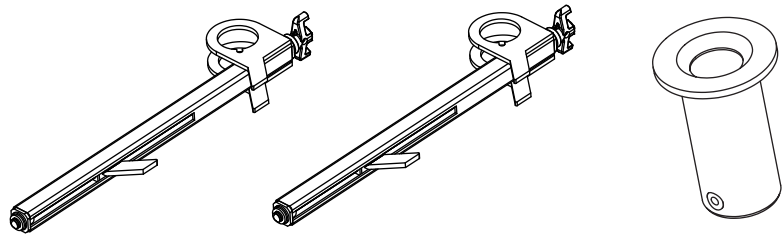

TRIPOD

Component that supports and stabilizes the Alsipercha.

Part ID: **13892**

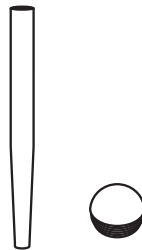

CONICAL TUBE

Component that is cast into the concrete column and houses the Alsipercha fall arrest system.

Part ID: **13890**

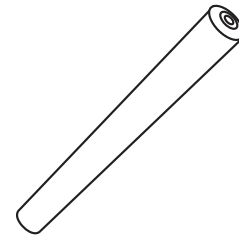

LEVELING ELEMENT

Component that is introduced into the cast-in tube, in order to ensure it's vertical and prevents the housing tube from rising under the pressure of the concrete.

Part ID: **13897**



"L" Frame



Column Clamps



Conical Tube



Tripod

Alsipercha Individual Part Descriptions

ALSIPERCHA

Inverted "L" shaped unit, anchored in the column.
Dimensions: 14'-3" x 8'x2"
Weight: 177 lbs.
Part ID: **13891**

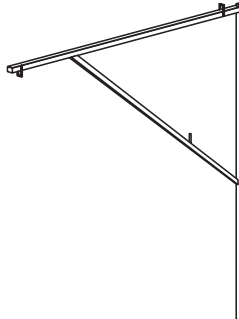

COLUMN CLAMP

(two required)
Column clamp to anchor the Alsipercha body to steel wide flange columns (with dimensions from 6 to 18 inches)
Dimensions: 2' x 6"
Weight: 13 lbs.
Part ID: **13893**

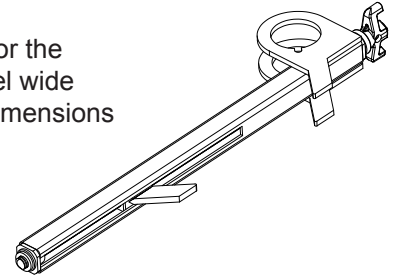

HOOK

Component used to bring the Alsipercha fall arrest system closer to the worker when changing the anchorage.
Dimensions: 9'-4" x 6"
Weight: 4.5 lbs.
Part ID: **13896**

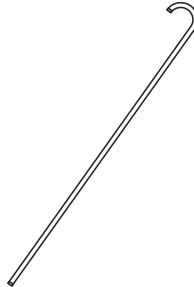

COLUMN CLAMP SLEEVE

Accessory that serves as housing for the Alsipercha main body.
Dimensions: 6"
Weight: 3 lbs.
Part ID: **13894**

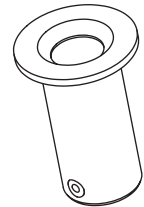

SLING

An essential component used to move the assembly with a crane, to take it to the column, or remove it once the work is complete.
Dimensions: 9' x 2"
Weight: 1.5 lbs.
Part ID: **13910**

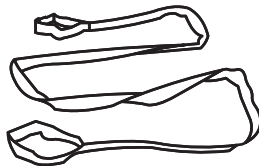

CONICAL TUBE

Component that is cast into the concrete column and houses the Alsipercha fall arrest system.
Dimensions: 3'
Weight: 6 lbs.
Part ID: **13890**

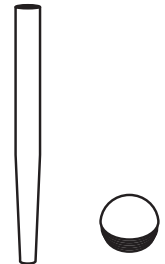

TRIPOD

Component that supports and stabilizes the Alsipercha.
Dimensions:
Folded - 10" x 10"
Unfolded - 10' H x 8' (Base)
Weight: 216 lbs.
Part ID: **13892**

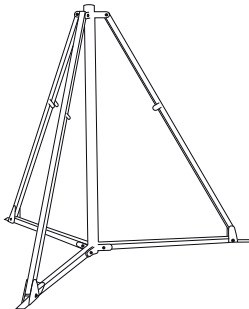

LEVELING ELEMENT

Component that is introduced into the cast-in tube, in order to ensure it's vertical and prevents the Housing Tube S.A. from rising under the pressure of the concrete.
Dimensions: 3' x 4"
Weight: 9 lbs.
Part ID: **13897**

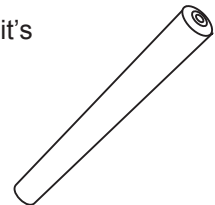

E1636 Rev. 2/26/20