



Turn to the experts

Product Data

WeatherMaster® Single Packaged Rooftop

3 to 5 Nominal Tons

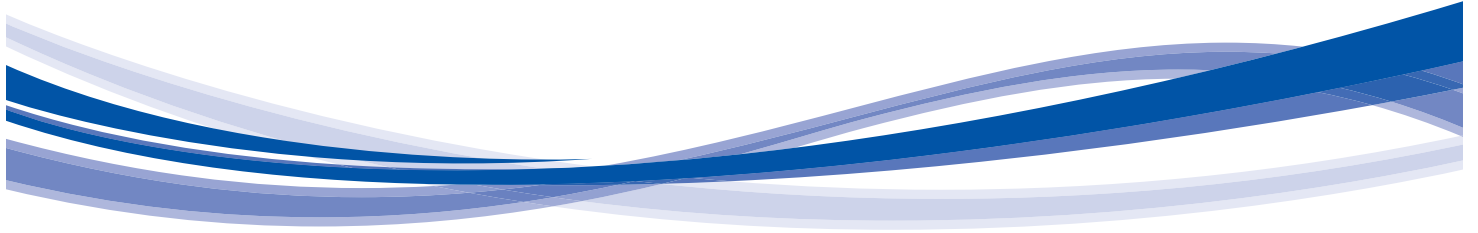

ecoblue™  technology



48/50GC**04, 05, 06

48GC: Single-Package Gas Heating/Electric Cooling Rooftop Units

50GC: Electric Cooling Rooftop Units with Optional Electric Heat
with Puron® Refrigerant (R-410A)

The New Carrier WeatherMaster® rooftop units (RTU) with EcoBlue™ Technology were designed by customers for customers and integrate new technology to provide value added benefits never seen in this type of equipment before.

New major design features include:

- Patent pending, Industry’s first efficient indoor fan system using Vane Axial Fan technology – with electric commutated variable speed motor.
- Reliable two stage scroll compressor on all sizes.
- Upgraded unit control board with intuitive indoor fan adjustment.
- Reliable copper tube/aluminum fin condenser coil with 5/16-in. tubing to help reduce refrigerant charge verses prior designs.
- New outdoor fan system with rugged – lightweight high impact composite fan blade

48/50GC WeatherMaster® units up to 5 tons are specifically designed to fit on Carrier roof curbs that were installed back to 1989, which makes replacement easy and eliminates the need for curb adapters or changing utility connections.

Two stage cooling capacity control delivers SEERs up 16.1. All models are capable of either vertical or horizontal airflow.

The Carrier rooftop unit (RTU) was designed by customers for customers. With “no-strip” screw collars, handled

access panels, and more, the unit is easy to install, easy to maintain, and easy to use. Your new 3 to 5 ton WeatherMaster Carrier rooftop unit (RTU) provides optimum comfort and control from a packaged rooftop.

Value-added features include:

- optional Humidi-MiZer® adaptive dehumidification system for improved part load humidity performance
- Puron® refrigerant (R-410A)
- single point gas and electrical connections
- optional fully integrated SystemVu™ controls
- RTU Open controller for BACnet¹, LonWorks², Modbus³ and Johnson Controls N2
- optional fully insulated cabinet with optional foil faced insulation
- TXV refrigerant metering system
- Scroll compressors with internal line-break overload protection
- Units come with an easy access tool-less filter door. Filter track tilts out for filter removal and replacement. All filters are the same size in each unit.

Installation ease

All WeatherMaster units are field-convertible to horizontal airflow, which makes it easy to adjust to unexpected

1. BACnet is a registered trademark of ASHRAE (American Society of Heating, Refrigerating and Air-Conditioning Engineers).
2. LonWorks is a registered trademark of Echelon Corporation.
3. Modbus is a registered trademark of Schneider Electric.

job-site complications. Lighter units make for easy replacement. Simple, fast plug-in connections to the standard integrated unit control board (UCB). Clearly labeled connections points to reduce installation time. Also, a large control box provides room to work and room to mount Carrier accessory controls.

Easy to maintain

With the new EcoBlue Vane Axial fan system and direct drive ECM motor — there is no longer a need to adjust belts or pulleys as in past designs. This frees up maintenance and installation time.

Easy access handles by Carrier provide quick and easy access to all normally serviced components. Our “no-strip” screw system has superior holding power and guides screws into position while preventing the screw from stripping the unit’s metal.

Sloped, corrosion resistant composite drain pan sheds water; and won’t rust.

Easy to use

The newly re-designed Unit Control Board by Carrier puts all connections and troubleshooting points in one convenient place. Most low voltage connections are made to the same board and make it easy to access it. Setting up the fan is simple by an intuitive switch and rotary dial arrangement. Carrier rooftops have high and low pressure switches, a filter drier, and 2-in. filters standard.

Table of contents

	Page
Features/Benefits	2
Model Number Nomenclature	4
Capacity Ratings	6
Physical Data	10
Options and Accessories	14
Base Unit Dimensions	19
Accessory Dimensions	25
Performance Data	26
Fan Data	40
Electrical Data	89
Typical Wiring Diagrams	115
Sequence of Operation	123
Application Data	126
Guide Specifications	128

Features/Benefits (cont)



EcoBlue Technology

Direct drive EcoBlue™ Technology indoor fan system uses Vane Axial fan design and electrically commutated motors.

This new Vane Axial design over past belt drive systems has 75% fewer moving parts, uses up to 40% less energy and has no fan belts, blower bearings and shaft.

Streamlined control and integration

Carrier controllers make connecting WeatherMaster® rooftops into existing building automation systems easy. The units are compatible with conventional

thermostat controls, SystemVu™ controls and Carrier RTU Open multi-protocol controller.

Operating efficiency and flexibility

The 48/50GC rooftops exceed ASHRAE (American Society of Heating, Refrigerating, and Air-Conditioning Engineers) 90.1-2016, IECC¹ (International Energy Conservation Code) IECC-2018 minimum efficiency requirements.

Field convertible airflow

All WeatherMaster 3 to 5 ton units are field-convertible to horizontal airflow, which makes it easy to adjust to unexpected job-site.

Comfort control

Carrier's patented Humidi-MiZer® adaptive dehumidification system is an all-inclusive factory-installed option on gas heating/electric cooling and electric cooling/electric heat models. This system provides reliable, flexible operation to meet indoor part load sensible and latent requirements.

1. IECC is a registered trademark of the International Code Council, Inc.

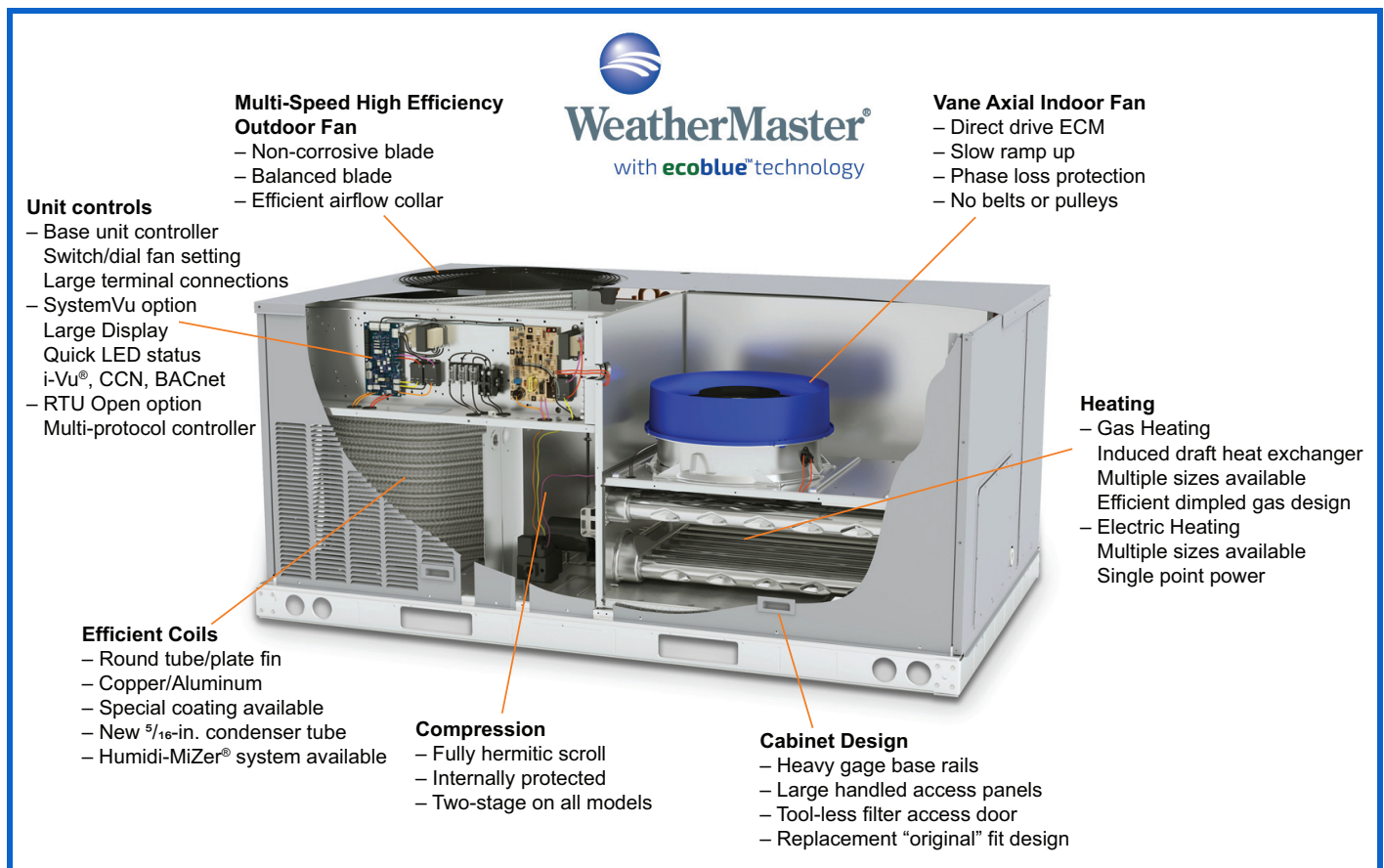

48GC MODEL NUMBER NOMENCLATURE

Position:	1	2	3	4	5	6	7	8	9	10	11	12	13	14	15	16	17	18
Example:	4	8	G	C	D	M	0	4	A	2	A	5	-	0	A	0	A	0

Unit Heat Type
48 - Gas Heat Packaged Rooftop

Model Series - WeatherMaster®
GC - 16.1 SEER Efficiency

Heat Options
D = Low Gas Heat
E = Medium Gas Heat
F = High Gas Heat
L = Low NOx – Low Gas Heat*
S = Low Heat w/ Stainless Steel Exchanger
R = Medium Heat w/ Stainless Steel Exchanger
T = High Heat w/ Stainless Steel Exchanger
* Low NOx models include – Stainless Steel HX

Refrig. Systems Options
M = Two Stage Cooling
N = Two Stage Cooling with Humidi-MiZer® system (includes Low Ambient control)
P = Two Stage Cooling with Low Ambient control

Cooling Tons
04 - 3 ton
05 - 4 ton
06 - 5 ton

Sensor Options
A = None
B = RA (Return Air) Smoke Detector
C = SA (Supply Air) Smoke Detector
D = RA + SA Smoke Detector
E = CO₂
F = RA Smoke Detector and CO₂
G = SA Smoke Detector and CO₂
H = RA + SA Smoke Detector and CO₂
J = Condensate Overflow Switch (electro-mechanical controls only)
K = Condensate Overflow Switch and RA Smoke Detector
L = Condensate Overflow Switch and RA and SA Smoke Detectors
M = Condensate Overflow Switch and SA Smoke Detector

Indoor Fan Options
1 = Direct Drive EcoBlue™ - Standard Static
2 = Direct Drive EcoBlue - Medium Static
3 = Direct Drive EcoBlue - High Static

Coil Options - Round Tube/Plate Fin Condenser Coil (Outdoor - Indoor - Hail Guard)
A = Al/Cu - Al/Cu
B = Precoat Al/Cu - Al/Cu
C = E-coat Al/Cu - Al/Cu
D = E-coat Al/Cu - E-coat Al/Cu
E = Cu/Cu - Al/Cu
F = Cu/Cu - Cu/Cu
M = Al/Cu - Al/Cu — Louvered Hail Guard
N = Precoat Al/Cu - Al/Cu — Louvered Hail Guard
P = E-coat Al/Cu - Al/Cu — Louvered Hail Guard
Q = E-coat Al/Cu - E-coat Al/Cu — Louvered Hail Guard
R = Cu/Cu - Al/Cu — Louvered Hail Guard
S = Cu/Cu - Cu/Cu — Louvered Hail Guard

Factory Assigned
0 = Standard
1 = LTL

Electrical Options
A = None
B = HACR Breaker
C = Non-Fused Disconnect (NFD)
D = Thru-The-Base (TTB) Connections
F = Non-Fused Disconnect and TTB
N = Phase Monitor Protection
P = Phase Monitor and HACR
Q = Phase Monitor and NFD
R = Phase Monitor and TTB
S = Phase Monitor and HACR and TTB
T = Phase Monitor and NFD and TTB

Service Options
0 = None
1 = Unpowered Convenience Outlet
2 = Powered Convenience Outlet
3 = Hinged Access Panels
4 = Hinged Access Panels and Unpowered Convenience Outlet
5 = Hinged Panels and Powered Convenience Outlet
6 = MERV 8 Filters
C = Foil Faced Insulation

Intake / Exhaust Options
A = None
B = Temperature Economizer w/ Barometric Relief
F = Enthalpy Economizer w/ Barometric Relief
U = Temperature Ultra Low Leak Economizer w/ Barometric Relief
W = Enthalpy Ultra Low Leak Economizer w/ Barometric Relief

Base Unit Controls
0 = Electro-mechanical Controls - can be used with field-installed W7212 EconoMiSer® IV (Non-Fault Detection and Diagnostic)
2 = RTU Open Multi-Protocol Controller
3 = SystemVu™ Controls
6 = Electro-mechanical Controls - can be used with W7220 EconoMiSer X (with Fault Detection and Diagnostic)

Design Revision
- = Factory Design Revision

Voltage
1 = 575/3/60
3 = 208-230/1/60
5 = 208-230/3/60
6 = 460/3/60

Note: On single phase (-3 voltage code) models, the following are not available as a factory-installed option:
- Humidi-MiZer System
- Coated Coils or Cu Fin Coils
- Louvered Hail Guards
- Economizer
- Powered 115 Volt Convenience Outlet

Model number nomenclature (cont)



50GC MODEL NUMBER NOMENCLATURE

Position:	1	2	3	4	5	6	7	8	9	10	11	12	13	14	15	16	17	18
Example:	5	0	G	C	-	M	0	4	A	1	A	5	-	0	A	0	A	0

Unit Heat Type

50 - Electric Heat
Packaged Rooftop

Model Series - WeatherMaster®

GC - 16.1 SEER Efficiency

Heat Options

- = No Heat
A = Low Electric Heat
B = Medium Electric Heat
C = High Electric Heat

Refrig. Systems Options

M = Two Stage Cooling Models
N = Two Stage Cooling Models with Humidi-MiZer® system (includes Low Ambient control)
P = Two Stage Cooling Models with Low Ambient control

Cooling Tons

04 - 3 ton
05 - 4 ton
06 - 5 ton

Sensor Options

A = None
B = RA (Return Air) Smoke Detector
C = SA (Supply Air) Smoke Detector
D = RA + SA Smoke Detector
E = CO₂
F = RA Smoke Detector and CO₂
G = SA Smoke Detector and CO₂
H = RA + SA Smoke Detector and CO₂
J = Condensate Overflow Switch
K = Condensate Overflow Switch and RA Smoke Detectors
L = Condensate Overflow Switch and RA and SA Smoke Detectors
M = Condensate Overflow Switch and SA Smoke Detectors

Indoor Fan Options

1 = Direct Drive – EcoBlue – Standard Static
2 = Direct Drive – EcoBlue – Medium Static
3 = Direct Drive – EcoBlue – High Static

Coil Options (RTPF) (Outdoor - Indoor - Hail Guard)

A = Al/Cu - Al/Cu
B = Precoat Al/Cu - Al/Cu
C = E-coat Al/Cu - Al/Cu
D = E-coat Al/Cu - E-coat Al/Cu
E = Cu/Cu - Al/Cu
F = Cu/Cu - Cu/Cu
M = Al/Cu - Al/Cu — Louvered Hail Guard
N = Precoat Al/Cu - Al/Cu — Louvered Hail Guard
P = E-coat Al/Cu - Al/Cu — Louvered Hail Guard
Q = E-coat Al/Cu - E-coat Al/Cu — Louvered Hail Guard
R = Cu/Cu - Al/Cu — Louvered Hail Guard
S = Cu/Cu - Cu/Cu — Louvered Hail Guard

Factory Assigned

0 = Standard
1 = LTL

Electrical Options

A = None
B = HACR Breaker
C = Non-Fused Disconnect (NFD)
D = Thru-The-Base Connections (TTB)
E = HACR and Thru-The-Base Connections
F = Non-Fused Disconnect and TTB
N = Phase Monitor Protection
P = Phase Monitor and HACR
Q = Phase Monitor and NFD
R = Phase Monitor and TTB
S = Phase Monitor and HACR and TTB
T = Phase Monitor and NFD and TTB

Service Options

0 = None
1 = Unpowered Convenience Outlet
2 = Powered Convenience Outlet
3 = Hinged Panels
4 = Hinged Panels and Unpowered Convenience Outlet
5 = Hinged Panels and Powered Convenience Outlet
6 = MERV 8 Filters
C = Foil Faced Insulation

Intake / Exhaust Options

A = None
B = Temperature Economizer w/ Barometric Relief
F = Enthalpy Economizer w/ Barometric Relief
U = Temperature Ultra Low Leak Economizer w/ Barometric Relief
W = Enthalpy Ultra Low Leak Economizer w/ Barometric Relief

Base Unit Controls

0 = Electro-mechanical controls - can be used with field-installed W7212 EconoMi\$er® IV (Non-Fault Detection and Diagnostic)
2 = RTU Open Multi-Protocol Controller
3 = SystemVu™ Controller
6 = Electro-mechanical - can be used with W7220 EconoMi\$er X (with Fault Detection and Diagnostic)

Design Revision

- = Factory Design Revision

Voltage

1 = 575/3/60
3 = 208-230/1/60
5 = 208-230/3/60
6 = 460/3/60

Note: On single phase (-3 voltage code) models, the following are not available as factory-installed options:

- Humidi-MiZer® System
- Coated Coils or Cu Fin Coils
- Louvered Hail Guards
- Economizer
- Powered 115 Volt Convenience Outlet

48GC AHRI RATINGS

48GC UNIT	COOLING STAGES	NOMINAL CAPACITY (TONS)	NET COOLING CAPACITY (MBH)	TOTAL POWER (kW)	SEER	EER
48GC*M04	2	3	35.2	2.9	16.1	12.5
48GC*M05	2	4	47.0	3.9	16.1	12.0
48GC*M06	2	5	60.0	5.0	16.1	12.5

LEGEND

- AHRI** — Air-Conditioning, Heating and Refrigeration Institute
EER — Energy Efficiency Ratio
IEER — Integrated Energy Efficiency Ratio
SEER — Seasonal Energy Efficiency Ratio

NOTES:

- Rated in accordance with AHRI Standards 210/240.
- Rating are based on:
Cooling Standard: 80°F (27°C) db, 67°F (19°C) wb indoor air temperature and 95°F (35°C) db outdoor air temperature.
- All 48GC units comply with ASHRAE 90.1-2016 (American Society of Heating, Refrigerating, and Air-Conditioning Engineers) and DOE-2018 (Department of Energy) Energy Standard for minimum SEER and EER requirements.
- 48GC units comply with US Energy Policy Act (2005). To evaluate code compliance requirements, refer to state and local codes.



50GC AHRI RATINGS

50GC UNIT	COOLING STAGES	NOMINAL CAPACITY (TONS)	NET COOLING CAPACITY (MBH)	TOTAL POWER (kW)	SEER	EER
50GC*M04	2	3	35.2	2.9	16.1	12.5
50GC*M05	2	4	47.0	3.9	16.1	12.2
50GC*M06	2	5	60.0	4.9	16.1	12.5

LEGEND

- AHRI** — Air-Conditioning, Heating and Refrigeration Institute
EER — Energy Efficiency Ratio
IEER — Integrated Energy Efficiency Ratio
SEER — Seasonal Energy Efficiency Ratio

NOTES:

- Rated in accordance with AHRI Standards 210/240.
- Rating are based on:
Cooling Standard: 80°F (27°C) db, 67°F (19°C) wb indoor air temperature and 95°F (35°C) db outdoor air temperature.
- All 50GC units comply with ASHRAE 90.1-2016 (American Society of Heating, Refrigerating, and Air-Conditioning Engineers) and DOE-2018 (Department of Energy) Energy Standard for minimum SEER and EER requirements.
- 50GC units comply with US Energy Policy Act (2005). To evaluate code compliance requirements, refer to state and local codes.



SOUND RATINGS TABLE

48/50GC UNIT	COOLING STAGES	OUTDOOR SOUND (dB) AT 60 Hz								
		A-WEIGHTED	63	125	250	500	1000	2000	4000	8000
M04	2	79	85.6	84.7	80.5	76.0	72.4	68.0	62.8	59.3
M05	2	79	85.6	84.7	80.5	76.0	72.4	68.0	62.8	59.3
M06	2	79	85.6	84.7	80.5	76.0	72.4	68.0	62.8	59.3

LEGEND

dB — Decibel

NOTES:

- Outdoor sound data is measured in accordance with AHRI.
- Measurements are expressed in terms of sound power. Do not compare these values to sound pressure values because sound pressure depends on specific environmental factors which normally do not match individual applications. Sound power values are independent of the environment and therefore more accurate.
- A-weighted sound ratings filter out very high and very low frequencies, to better approximate the response of “average” human ear. A-weighted measurements for Carrier units are taken in accordance with AHRI.

Capacity ratings (cont)



MINIMUM - MAXIMUM AIRFLOW RATINGS (CFM) — NATURAL GAS AND PROPANE

UNIT	HEAT LEVEL	VOLTAGE	COOLING				HEATING*	
			MINIMUM AIRFLOW CFM	MINIMUM 2- SPEED AIRFLOW (LOW SPEED)	MINIMUM 2- SPEED AIRFLOW (HIGH SPEED)	MAXIMUM AIRFLOW CFM	MINIMUM AIRFLOW CFM	MAXIMUM AIRFLOW CFM
48GC**04	LOW	1 PHASE	900	675	900	1500	890	1950
	MED						800	1520
	HIGH						N/A	N/A
48GC**05	LOW	1 PHASE	1200	900	1200	2000	890	2440
	MED						1050	2280
	HIGH						1220	2170
48GC**06	LOW	1 PHASE	1500	1125	1500	2500	890	3250
	MED						1050	2730
	HIGH						1220	2790
48GC**04	LOW	3 PHASE	900	675	900	1500	910	2010
	MED						960	1160
	HIGH						N/A	N/A
48GC**05	LOW	3 PHASE	1200	900	1200	2000	910	2010
	MED						1250	2330
	HIGH						1390	2220
48GC**06	LOW	3 PHASE	1500	1125	1500	2500	910	2510
	MED						1250	2720
	HIGH						1390	2780

* Heating rating values are identical for aluminum heat exchangers and stainless steel heat exchangers.

MINIMUM - MAXIMUM AIRFLOW RATINGS (CFM) — COOLING UNITS AND ACCESSORY ELECTRIC HEAT

UNIT	COOLING				ELECTRIC HEAT*	
	MINIMUM AIRFLOW CFM	MINIMUM 2-SPEED AIRFLOW (LOW SPEED)	MINIMUM 2-SPEED AIRFLOW (HIGH SPEED)	MAXIMUM AIRFLOW CFM	MINIMUM AIRFLOW CFM	MAXIMUM AIRFLOW CFM
50GC**04	900	675	900	1500	900	1500
50GC**05	1200	900	1200	2000	1200	2000
50GC**06	1500	1125	1500	2500	1500	2500

* Electric heat modules are available as both factory-installed options or field-installed accessories for 50GC units.

Capacity ratings (cont)



HEAT RATING TABLE — NATURAL GAS AND PROPANE

48GC UNIT		GAS HEAT	AL/SS HEAT EXCHANGER		TEMPERATURE RISE (°F)	THERMAL EFFICIENCY (%)	AFUE EFFICIENCY (%)
			INPUT/OUTPUT STAGE 1 (MBH)	INPUT/OUTPUT STAGE 2 (MBH)			
Single Phase	04	LOW	-/-	65/53	25-55	81	81
		MED	-/-	90/73	45-85	82	81
		HIGH	-/-	—	—	—	—
	05	LOW	-/-	65/53	20-55	81	81
		MED	-/-	90/73	30-65	82	81
		HIGH	-/-	130/106	45-80	81	81
	06	LOW	-/-	65/53	15-55	81	81
		MED	-/-	90/73	25-65	82	81
		HIGH	-/-	130/106	35-80	81	81
Three Phase	04	LOW	50/40	67/54	25-55	81	N/A
		MED	82/65	110/88	50-85	80	N/A
		HIGH	—	—	—	—	—
	05	LOW	50/40	67/54	25-55	81	N/A
		MED	82/65	110/88	35-65	80	N/A
		HIGH	120/96	150/120	50-80	80	N/A
	06	LOW	50/40	67/54	20-55	81	N/A
		MED	82/65	110/88	30-65	80	N/A
		HIGH	120/96	150/120	40-80	80	N/A

HEAT RATING TABLE — LOW NO_x

48GC UNIT		GAS HEAT	AL/SS HEAT EXCHANGER		TEMPERATURE RISE (°F)	THERMAL EFFICIENCY (%)	AFUE EFFICIENCY (%)
			INPUT/OUTPUT STAGE 1 (MBH)	INPUT/OUTPUT STAGE 2 (MBH)			
Single Phase	04	LOW	—	60 / 49	20 - 50	81%	81%
	05	LOW	—	60 / 49	20 - 50	81%	81%
	06	LOW	—	60 / 49	15 - 50	81%	81%
Three Phase	04	LOW	—	60 / 49	20 - 50	81%	n/a
	05	LOW	—	60 / 49	20 - 50	81%	n/a
	06	LOW	—	60 / 49	15 - 50	81%	n/a

48/50GC 3 TO 5 TON PHYSICAL DATA

48/50GC UNIT	48/50GC*M04	48/50GC*N04	48/50GC*M05	48/50GC*N05	48/50GC*M06	48/50GC*N06
NOMINAL TONS	3		4		5	
BASE UNIT OPERATING WT (lb) 48GC/50GC*	513/468		555/510		600/555	
REFRIGERATION SYSTEM						
No. Circuits/No. Compressors/Type	1 / 1 / 2-Stage Scroll					
Puron® (R-410A) charge A/B (lbs-oz)	8-4	—	8-11	—	11-0	—
Humidi-MiZer® Puron (R-410A) charge A/B (lbs-oz)	—	8-3	—	14-8	—	18-0
Metering device	TXV					
Humidi-MiZer metering device	—	TXV	—	TXV	—	TXV
High-Pressure Trip/Reset (psig)	630/505					
Low-Pressure Trip/Reset (psig)	54/117	27/44	54/117	27/44	54/117	27/44
EVAPORATOR COIL						
Material (Tube/Fin)	Cu/Al					
Coil Type	3/8-in. RTPF					
Rows/FPI	2/15	—	—	—	4/15	—
Total Face Area (ft ²)	5.5		—		7.3	
Condensate Drain Connection Size	3/4-in.					
CONDENSER COIL						
Material	Cu/Al					
Coil Type	5/16-in. RTPF					
Rows/FPI	2/18					
Total Face Area (ft ²)	14.6	—	15.9	—	20.5	
HUMIDI-MIZER COIL						
Material	—	Cu/Al	—	Cu/Al	—	Cu/Al
Coil Type	—	3/8-in. RTPF	—	3/8-in. RTPF	—	3/8-in. RTPF
Rows/FPI	—	1/17	—	2/17	—	2/17
Total Face Area (ft ²)	—	4.1	—	4.1	—	5.5
EVAPORATOR FAN AND MOTOR						
Standard Static 1 Phase						
Motor Qty/Drive Type	1/Direct	—	1/Direct	—	1/Direct	—
Max Cont BHP	0.44	—	0.72	—	1.06	—
RPM Range	189-1890	—	190-1900	—	215-2150	—
Fan Qty/Type	1/Vane Axial	—	1/Vane Axial	—	1/Vane Axial	—
Fan Diameter (in.)	16.6	—	16.6	—	16.6	—
Medium Static 1 Phase						
Motor Qty/Drive Type	1/Direct	—	1/Direct	—	1/Direct	—
Max Cont BHP	0.71	—	1.06	—	1.44	—
RPM Range	219-2190	—	217-2170	—	239-2390	—
Fan Qty/Type	1/Vane Axial	—	1/Vane Axial	—	1/Vane Axial	—
Fan Diameter (in.)	16.6	—	16.6	—	16.6	—
High Static 1 Phase						
Motor Qty/Drive Type	1/Direct	—	1/Direct	—	—	—
Max Cont BHP	1.07	—	1.53	—	—	—
RPM Range	249-2490	—	246-2460	—	—	—
Fan Qty/Type	1/Vane Axial	—	1/Vane Axial	—	—	—
Fan Diameter (in.)	16.6	—	16.6	—	—	—
Standard Static 3 Phase						
Motor Qty/Drive Type	—		1/Direct		—	
Max Cont BHP	0.44	—	0.72	—	1.06	—
RPM Range	189-1890	—	190-1900	—	215-2150	—
Fan Qty/Type	—		1/Vane Axial		—	
Fan Diameter (in.)	—		16.6		—	
Medium Static 3 Phase						
Motor Qty/Drive Type	—		1/Direct		—	
Max Cont BHP	0.71	—	1.06	—	1.44	—
RPM Range	219-2190	—	217-2170	—	239-2390	—
Fan Qty/Type	—		1/Vane Axial		—	
Fan Diameter (in.)	—		16.6		—	
High Static 3 Phase						
Motor Qty/Drive Type	—		1/Direct		—	
Max Cont BHP	1.07	—	1.96	—	2.43	—
RPM Range	249-2490	—	266-2660	—	284-2836	—
Fan Qty/Type	—		1/Vane Axial		—	
Fan Diameter (in.)	—		16.6		—	

Physical data (cont)



48/50GC 3 TO 5 TON PHYSICAL DATA (cont)

48/50GC UNIT	48/50GC*M04	48/50GC*N04	48/50GC*M05	48/50GC*N05	48/50GC*M06	48/50GC*N06
CONDENSER FAN AND MOTOR						
Qty / Motor Drive Type	1 / Direct					
Motor HP/RPM	1/5 / 825/675		1/4 / 1100/900			
Fan Diameter (in.)	23					
FILTERS						
RA Filter Qty / Size (in.)	2 / 16x25x2			4 / 16x16x2		
OA Inlet Screen Qty / Size (in.)	1 / 20x24x1					

LEGEND

- BHP** — Break Horsepower
- FPI** — Fins Per Inch
- OA** — Outdoor Air
- RA** — Return Air

* Base unit operating weight does not include weight of options.

Physical data (cont)



48GC 3 TO 5 TON GAS HEAT DATA — 1 PHASE UNITS

48GC UNIT	48GC**04	48GC**05	48GC**06
GAS CONNECTION			
No. of Gas Valves		1	
Natural Gas Supply Line Pressure (in. wg)/(psig)		4-13 / 0.18-0.47	
Liquid Propane Supply Line Pressure (in. wg)/(psig)		11-13 / 0.40-0.47	
HEAT ANTICIPATOR SETTING (AMPS)			
First Stage		0.14	
Second Stage		0.14	
NATURAL GAS HEAT			
LOW			
No. of Stages / No. of Burners (total)		1 / 2	
Connection Size		1/2-in. NPT	
Rollout Switch Opens / Closes (°F)		195 / 115	
Temperature Rise (°F)	25-55	20-55	15-55
MEDIUM			
No. of Stages / No. of Burners (total)		1 / 3	
Connection Size		1/2-in. NPT	
Rollout Switch Opens / Closes (°F)		195 / 115	
Temperature Rise (°F)	45-85	30-65	25-65
HIGH			
No. of Stages / No. of Burners (total)	—	1 / 3	
Connection Size	—	1/2-in. NPT	
Rollout Switch Opens / Closes (°F)	—	195 / 115	
Temperature Rise (°F)	—	45-80	35-80
LIQUID PROPANE HEAT			
LOW			
No. of Stages / No. of Burners (total)		1 / 2	
Connection Size		1/2-in. NPT	
Rollout Switch Opens / Closes (°F)		195 / 115	
Temperature Rise (°F)	25-55	20-55	15-55
MEDIUM			
No. of Stages / No. of Burners (total)		1 / 3	
Connection Size		1/2-in. NPT	
Rollout Switch Opens / Closes (°F)		195 / 115	
Temperature Rise (°F)	45-85	30-65	25-65
HIGH			
No. of Stages / No. of Burners (total)	—	1 / 3	
Connection Size	—	1/2-in. NPT	
Rollout Switch Opens / Closes (°F)	—	195 / 115	
Temperature Rise (°F)	—	45-80	35-80
LOW NOx HEAT			
LOW			
No. of Stages / No. of Burners (total)		1 / 2	
Connection Size		1/2-in. NPT	
Rollout Switch Opens / Closes (°F)		195 / 115	
Temperature Rise (°F)	20-50		15-50

Physical data (cont)



48GC 3 TO 6 TON GAS HEAT DATA — 3 PHASE UNITS

48GC UNIT	48GC**04	48GC**05	48GC**06
GAS CONNECTION			
No. of Gas Valves		1	
Natural Gas Supply Line Pressure (in. wg)/(psig)		4-13 / 0.18-0.47	
Liquid Propane Supply Line Pressure (in. wg)/(psig)		11-13 / 0.40-0.47	
HEAT ANTICIPATOR SETTING (AMPS)			
First Stage		0.14	
Second Stage		0.14	
NATURAL GAS HEAT			
LOW			
No. of Stages / No. of Burners (total)		2 / 2	
Connection Size		1/2-in. NPT	
Rollout Switch Opens / Closes (°F)		195 / 115	
Temperature Rise (°F)	25-55		20-55
MEDIUM			
No. of Stages / No. of Burners (total)		2 / 3	
Connection Size		1/2-in. NPT	
Rollout Switch Opens / Closes (°F)		195 / 115	
Temperature Rise (°F)	50-85	35-65	30-65
HIGH			
No. of Stages / No. of Burners (total)	—	2 / 3	
Connection Size	—	1/2-in. NPT	
Rollout Switch Opens / Closes (°F)	—	195 / 115	
Temperature Rise (°F)	—	50-80	40-80
LIQUID PROPANE HEAT			
LOW			
No. of Stages / No. of Burners (total)		2 / 2	
Connection Size		1/2-in. NPT	
Rollout Switch Opens / Closes (°F)		195 / 115	
Temperature Rise (°F)	25-55		20-55
MEDIUM			
No. of Stages / No. of Burners (total)		2 / 3	
Connection Size		1/2-in. NPT	
Rollout Switch Opens / Closes (°F)		195 / 115	
Temperature Rise (°F)	50-85	35-65	30-65
HIGH			
No. of Stages / No. of Burners (total)	—	2 / 3	
Connection Size	—	1/2-in. NPT	
Rollout Switch Opens / Closes (°F)	—	195 / 115	
Temperature Rise (°F)	—	50-80	40-80
LOW NOx HEAT			
LOW			
No. of Stages / No. of Burners (total)		1 / 2	
Connection Size		1/2-in. NPT	
Rollout Switch Opens / Closes (°F)		195 / 115	
Temperature Rise (°F)	20-50		15-50

Options and accessories



ITEM	OPTION*	ACCESSORY†
GAS HEAT (48GC units only)		
Low, Medium or High Gas Heat — Aluminized Heat Exchanger	X	
Low, Medium or High Gas Heat — Stainless Steel Heat Exchanger	X	
Low NOx, Low Heat — Stainless Steel Heat Exchanger	X	
Propane Conversion Kit		X
High Altitude Conversion Kit		X
Flue Discharge Deflector		X
Flue Shield		X
ELECTRIC HEAT (50GC units only)		
Electric Resistance Heaters	X	X
Single Point Kits		X
CABINET		
Thru-the-Base electrical or gas-line connections	X	X
Hinged Access Panels	X	
COIL OPTIONS		
Cu/Cu indoor and/or outdoor coils ¹	X	
Pre-coated outdoor coils ¹	X	
Premium, E-coated outdoor coils ¹	X	
HUMIDITY CONTROL		
Humidi-MiZer® Adaptive Dehumidification System ¹	X	
CONDENSER PROTECTION		
Condenser coil hail guard (louvered design) ¹	X	X
CONTROLS		
Thermostats, temperature sensors, and subbases		X
SystemVu™ DDC communicating controller	X	
RTU Open Multi-Protocol controller	X	
Smoke detector (supply and/or return air)	X	
Horn Strobe Annunciator ²		X
Time Guard II compressor delay control circuit		X
Phase Monitor		X
Condensate Overflow switch	X	X
FILTERS		
MERV-8 Return Air Filters	X	

ITEM	OPTION*	ACCESSORY†
ECONOMIZERS AND OUTDOOR AIR DAMPERS		
EconoMi\$er® IV for electro-mechanical controls - Non FDD (Standard air leak damper models) ^{1, 3}		X
EconoMi\$er2 for DDC controls (Standard and Ultra Low Leak air damper models) ^{1, 4}	X	X
EconoMi\$er X for electro-mechanical controls, complies with FDD (Standard and Ultra Low Leak damper models) ^{1, 3}	X	X
Motorized 2-position outdoor-air damper ¹		X
Manual outdoor-air damper (25% and 50%)		X
Barometric relief ⁵	X	X
Power exhaust - prop design		X
ECONOMIZER SENSORS AND IAQ DEVICES		
Single dry bulb temperature sensors ⁶	X	X
Differential dry bulb temperature sensors ⁶		X
Single enthalpy sensors ⁶	X	X
Differential enthalpy sensors ⁶		X
CO ₂ sensor (wall, duct, or unit mounted) ⁶	X	X
INDOOR MOTOR AND DRIVE		
Multiple motor and drive packages	X	
LOW AMBIENT CONTROL		
Winter start kit ⁷		X
Low Ambient controller to -20°F (-29°C) ⁷	X	X
POWER OPTIONS		
Convenience outlet (powered) ¹	X	
Convenience outlet (unpowered)	X	
HACR circuit breaker ⁸	X	
Non-fused disconnect ⁹	X	
ROOF CURBS		
Roof curb 14-in. (356 mm)		X
Roof curb 24-in. (610 mm)		X

* Factory-installed option.

† Field-installed accessory.

NOTES:

- Not available as a factory-installed option on single phase (-3 voltage code) models. Use field-installed accessory where available.
- Requires a field-supplied 24V transformer for each application. See price pages for details.
- FDD (Fault Detection and Diagnostic) capability per California Title 24 section 120.2.
- Models with SystemVu and RTU Open DDC controls comply with California Title 24 Fault Detection and Diagnostic (FDD).
- Included with economizer.
- Sensors used to optimize economizer performance.
- See application data for assistance.
- HACR circuit breaker cannot be used on 04-06 sizes when unit FLA electrical rating exceeds:
208/230/1/60 and 208/230/3/60 = 100 amps (FLA)
460/3/60 = 90 amps (FLA)
Carrier RTUBuilder automatically selects the amps limitations.
- Non-fused disconnect switch cannot be used when unit electrical rating exceeds:
Without factory-installed electric heat:
208-230/1/60 and 208-230/3/60 = 80 amps (FLA).
480/3/60 and 575/3/60 = 80 amps (FLA).
With factory-installed electric heat:
208-230/1/60 and 208-230/3/60 = 100 amps (FLA).
480/3/60 and 575/3/60 = 80 amps (FLA).
Carrier RTUBuilder automatically selects the amp limitations.

Factory-installed options

Economizer (dry-bulb or enthalpy)

Economizers save money. They bring in fresh, outside air for ventilation; and provide cool, outside air to cool your building. This is the preferred method of low-ambient cooling. When coupled to CO₂ sensors, economizers can provide even more savings by coupling the ventilation air to only that amount required.

Economizers are available, installed and tested by the factory, with either enthalpy or dry-bulb temperature inputs. Additional sensors are available as accessories to optimize the economizers. Economizers include a powered exhaust system to help equalize building pressures.

Economizers include gravity controlled barometric relief that helps equalize building pressure and ambient air pressures. This can be a cost effective solution to prevent building pressurization. Economizers are available in Ultra Low Leak and standard low leak versions. Economizers can be factory-installed or easily field-installed.

Unit mounted CO₂ sensor

The CO₂ sensor works with the economizer to intake only the correct amount of outside air for ventilation. As occupants fill your building, the CO₂ sensor detects their presence through increasing CO₂ levels, and opens the economizer appropriately. When the occupants leave, the CO₂ levels decrease, and the sensor appropriately closes the economizer. This intelligent control of the ventilation air, called demand controlled ventilation (DCV) reduces the overall load on the rooftop, saving money. Also available as a field-installed accessory.

Smoke detector (supply and/or return air)

Trust the experts. Smoke detectors make your application safer and your job easier. Carrier smoke detectors immediately shut down the rooftop unit when smoke is detected. They are available, installed by the factory, for supply air, return air, or both.

Optional Humidi-MiZer® adaptive dehumidification system

Carrier's Humidi-MiZer adaptive dehumidification system is an all-inclusive factory-installed option that can be ordered with any WeatherMaster® 48/50GC04-06 rooftop unit, with the exception of single phase voltage (208-230/1/60) units.

This system expands the envelope of operation of Carrier's WeatherMaker rooftop products to provide unprecedented flexibility to meet year round comfort conditions.

The Humidi-MiZer adaptive dehumidification system has a unique dual operational mode setting. The Humidi-MiZer system provides greater dehumidification of the occupied space by two modes of dehumidification operations in addition to its normal design cooling mode.

The WeatherMaster 48/50GC04-06 rooftop coupled with the Humidi-MiZer system is capable of operating in normal design cooling mode, sub-cooling mode, and hot gas reheat mode. Normal design cooling mode is when the unit will operate under its normal sequence of operation by cycling compressors to maintain comfort conditions.

Sub-cooling mode will operate to satisfy part load type conditions when the space requires combined sensible and a higher proportion of latent load control. Hot Gas Reheat mode will operate when outdoor temperatures diminish and the need for latent capacity is required for sole humidity control. Hot Gas Reheat mode will provide neutral air for maximum dehumidification operation.

NOTE: Humidi-MiZer system includes Low Ambient controller.

Thru-the-base connection

Thru-the-base connections, available as a factory option, are necessary to ensure proper connection and seal when routing wire and piping through the rooftop's basepan and curb. These couplings eliminate roof penetration and should be considered for gas lines, main power lines, as well as control power.

Hinged access panels

Allows access to unit's major components with specifically designed hinged access panels. Panels are filter, control box access indoor fan motor access.

Cu/Cu (indoor) coils

Copper fins and copper tubes are mechanically bonded to copper tubes and copper tube sheets. A polymer strip prevents coil assembly from contacting the sheet metal coil pan to minimize potential for galvanic corrosion between coil and pan.

E-coated (outdoor and indoor) coils

A flexible epoxy polymer coating uniformly applied to all coil surface areas without material bridging between fins. Coating process shall ensure complete coil encapsulation of tubes, fins and headers.

Pre-coated outdoor coils

A durable epoxy-phenolic coating to provide protection in mildly corrosive coastal environments. The coating minimizes galvanic action between dissimilar metals. Coating is applied to the aluminum fin stock prior to the fin stamping process to create an inert barrier between the aluminum fin and copper tube.

Condenser coil hail guard

Sleek, louvered panels protect the condenser coil from hail damage, foreign objects, and incidental contact.

Single enthalpy sensor

Prevents the wheel from rotating if the outside air conditions are acceptable for free cooling. Both exhaust and supply blowers will remain on.

Stainless steel heat exchanger (48GC units only)

The stainless steel heat exchanger option provides the tubular heat exchanger be made out of a minimum 20 gage type 409 stainless steel for applications where the mixed air to the heat exchanger is expected to drop below 45°F (7°C). Stainless steel may be specified on applications where the presence of airborne contaminants require its use (applications such as paper mills) or in area with very high outdoor humidity that may result in severe condensation in the heat exchanger during cooling operation.

Convenience outlet (powered or un-powered)

Reduce service and/or installation costs by including a convenience outlet in your specification. Carrier will install this service feature at our factory. Provides a convenient, 15 amp, 115v GFCI receptacle with “Wet in Use” cover. The “powered” option allows the installer to power the outlet from the line side of the disconnect or load side as required by code. The “unpowered” option is to be powered from a separate 115/120v power source.

The unpowered convenience outlet is available as a 15 amp factory-installed option or a 20 amp field-installed accessory.

HACR Breaker

These manual reset devices provide overload and short circuit protection for the unit. Factory wired and mounted with the units with access cover to provide protection from the environment.

Non-fused disconnect

This OSHA-compliant, factory-installed, safety switch allows a service technician to locally secure power to the rooftop. When selecting a factory-installed non-fused disconnect, note they are sized for the unit as ordered from the factory. The sizing of these do not accommodate field-installed items such as power exhaust devices, etc. If field installing electric heat with factory-installed non-fused disconnect switch, a single point kit may or may not be required.

SystemVu™ controller

Carrier’s SystemVu controller is an optional factory-installed and tested controller.

This controller takes on a whole new approach to provide an intuitive, intelligent controller that not only monitors and controls the unit, but also provides linkage to multiple building automation systems.

Each SystemVu controller makes it easy to set up, service, troubleshoot, gain historical data, generate reports and provide comfort only Carrier is noted for.

Key features include:

- Easy to read back lit four line text screen for superior visibility.
- Quick operational condition LEDs of: Run, Alert, and Fault.
- Simple navigation with large keypad buttons of: Navigation arrows, Test, Back, Enter and Menu.
- Capable of being controlled with a conventional thermostat, space sensor or build automation system.
- Service capabilities include:
 - Auto run test
 - Manual run test
 - Component run hours and starts
 - Commissioning reports
 - Data logging
- Full range of diagnosis:
 - Read refrigerant pressures without the need of gages
 - Sensor faults
 - Compressor reverse rotation
 - Economizer diagnostics that meet California Title 24 requirements

- Quick data transfer via USB port:
 - Unit configuration uploading/downloading
 - Data logging
 - Software upgrades
- Built in capacity for:
 - i-Vu® open systems
 - BACnet systems
 - CCN systems
- Configuration and alarm point capability:
 - Contain over 100 alarm codes
 - Contain over 260 status, troubleshooting, diagnostic and maintenance points
 - Contain over 270 control configuration setpoints

RTU Open, multi-protocol controller

Connect the rooftop to an existing BAS (building automation system) without needing complicated translators or adapter modules using the RTU Open controller. The RTU Open controller speaks the 4 most common building automation system languages (BACnet, Modbus, Johnson Controls N2, and LonWorks). Use this controller when you have an existing BAS. Besides the 4 protocols, it also communicates with a Carrier Open system (i-Vu and VVT®).

Condensate overflow switch

This sensor and related controller monitors the condensate level in the drain pan and shuts down compression operation when overflow conditions occur. It includes:

- Indicator light – solid red (more than 10 seconds on water contact – compressors disabled), blinking red (sensor disconnected)
- 10 second delay to break – eliminates nuisance trips from splashing or waves in pan (sensor needs 10 seconds of constant water contact before tripping)
- Disables the compressor(s) operation when condensate plug is detected, but still allows fans to run for economizer.

MERV-8 return air filters

This factory option upgrades the return air filters from standard unit filters to high efficiency MERV-8 filters. Non-woven MERV-8 filter media with high strength, moisture-resistant frame. Filter media is securely fastened inside the filter frame on all four sides.

Low ambient controller

The low ambient controller is a head pressure controller kit that is designed to maintain the unit’s condenser head pressure during periods of low ambient cooling operation. This device should be used as an alternative to economizer free cooling when economizer usage is either not appropriate or desired. The low ambient controller will either cycle the outdoor fan motors or operate them at reduced speed to maintain the unit operation, depending on the model. This controller allows cooling operation down to -20°F (-29°C) ambient conditions.

Electric Heaters

Carrier offers a full-line of field-installed accessory heaters. The heaters are very easy to use, install and are all pre-engineered and certified. Electric heaters are available as either factory-installed options or field-installed accessories.

Field-installed accessories

Filter maintenance indicator

When the optional factory-installed filter maintenance indicator is used, a factory-installed differential pressure switch measures pressure drop across the outside air filter and activates a field-supplied dry contact indicator when the pressure differential exceeds the adjustable switch setpoint.

Condenser coil hail guard

Sleek, louvered panels protect the condenser coil from hail damage, foreign objects, and incidental contact. This can be purchased as a factory-installed option or as a field-installed accessory.

Differential enthalpy sensor

The differential enthalpy sensor is comprised of an outdoor and return air enthalpy sensors to provide differential enthalpy control. The sensor allows the unit to determine if outside air is suitable for free cooling.

Wall or duct mounted CO₂ sensor

The IAQ sensor shall be available in duct or wall mount. The sensor provides demand ventilation indoor air quality (IAQ) control.

Propane conversion kit (48GC units only)

Convert your gas heat rooftop from standard natural gas operation to Propane using this field-installed kit.

High altitude conversion kit (48GC units only)

High altitudes have less oxygen, which affects the fuel/air mixture in heat exchangers. In order to maintain a proper fuel/air mixture, heat exchangers operating in altitudes above 2000 ft (610 m) require different orifices. To select the correct burner orifices or determine the heat capacity for a high altitude application, use either the selection software, or the unit's service manual. High altitudes have less oxygen, which means heat exchangers need less fuel. The new gas orifices in this field-installed kit make the necessary adjustment for high altitude applications. They restore the optimal fuel to air mixture and maintain healthy combustion on altitudes above 2000 ft (610 m).

NOTE: Typical natural gas heating value ranges from 975 to 1050 Btu/ft³ at sea level nationally. The heating value goes down approximately 1.7% per every thousand feet elevation. Standard factory orifices can typically be used up to 2000 ft (610 m) elevation without any operational issues.

Flue discharge deflector (48GC units only)

The flue discharge deflector is a useful accessory when flue gas recirculation is a concern. By venting the flue discharge upwards, the deflector minimizes the chance for a neighboring unit to intake the flue exhaust.

Winter start kit

The winter start kit by Carrier extends the low ambient limit of your rooftop to 25°F (-4°C). The kit bypasses the low pressure switch, preventing nuisance tripping of the low pressure switch. Other low ambient precautions may still be prudent.

Low Ambient controller

The Low Ambient controller is a head pressure controller kit that is designed to maintain the unit's condenser head pressure during periods of low ambient cooling operation. This device should be used as an alternative to economizer free cooling not when economizer usage is either not appropriate or desired. The low ambient controller will either cycle the outdoor-fan motors or operate them at reduced speed to maintain the unit operation, depending on the model. This controller allows cooling operation down to -20°F (-29°C) ambient conditions.

Roof curb (14-in./356 mm or 24-in./610 mm)

Full perimeter roof curb with exhaust capability provides separate air streams for energy recovery from the exhaust air without supply air contamination.

Filter status indicator accessory

Monitors static pressure across supply and exhaust filters and provides indication when filters become clogged.

Manual OA Damper

Manual outdoor air dampers are an economical way to bring in ventilation air. The dampers are available in 25% and 50% versions.

Motorized 2-Position Damper

The Carrier 2-position, motorized outdoor air damper admits up to 100% outside air. Using reliable, gear-driven technology, the 2-position damper opens to allow ventilation air and closes when the rooftop stops, stopping unwanted infiltration.

Time Guard II control circuit

This accessory protects your compressor by preventing short-cycling in the event of some other failure, prevents the compressor from restarting for 30 seconds after stopping. Not required with SystemVu™ controller, RTU Open controller, or authorized commercial thermostats.

Power exhaust

Superior internal building pressure control. This field-installed accessory may eliminate the need for costly, external pressure control fans.

Phase monitor protection

The Phase Monitor Control will monitor the sequence of three phase electrical system to provide a phase reversal protection; and monitor the three phase voltage inputs to provide a phase loss protection for the three phase device. It will work on either a Delta or Wye power connection.

OPTIONS AND ACCESSORY WEIGHTS

OPTION / ACCESSORY NAME	48/50GC UNIT WEIGHT					
	04		05		06	
	lb	kg	lb	kg	lb	kg
Humidi-MiZer® System*	15	7	15	7	24	11
Power Exhaust - vertical	51	23	51	23	51	23
Power Exhaust - horizontal	39	18	39	18	39	18
EconoMiSer® (X, IV or 2)	35	16	35	16	35	16
2-Position Damper	39	18	39	18	39	18
Manual Damper	12	5	12	5	12	5
Medium Gas Heat (48GC units only)	9	4	9	4	9	4
High Gas Heat (48GC units only)	—	—	63	29	63	29
Hail Guard (louvered)	13	6	13	6	17	8
Cu/Cu Condenser Coil	37	17	74	34	90	41
Cu/Cu Condenser and Evaporator Coils	75	34	112	51	160	73
Roof Curb (14-in. curb)	95	43	95	43	95	43
Roof Curb (24-in. curb)	150	68	150	68	150	68
CO ₂ sensor	2	1	2	1	2	1
Flue Discharge Deflector	7	3	7	3	7	3
Optional Indoor Motor/Drive	10	5	10	5	10	5
Low Ambient Controller	9	4	9	4	9	4
Winter Start Kit	5	2	5	2	5	2
Return Air Smoke Detector	7	3	7	3	7	3
Supply Air Smoke Detector	7	3	7	3	7	3
Fan Filter Switch	2	1	2	1	2	1
Non-Fused Disconnect	15	7	15	7	15	7
Powered Convenience Outlet	36	16	36	16	36	16
Unpowered Convenience Outlet	4	2	4	2	4	2
Enthalpy Sensor	2	1	2	1	2	1
Differential Enthalpy Sensor	3	1	3	1	3	1

LEGEND

— Not Available

* For Humidi-MiZer system add Low Ambient controller.

NOTE: Where multiple variations are available, the heaviest combination is listed.

Base unit dimensions



48GC**04-06 BASE UNIT DIMENSIONS

THIS DOCUMENT IS THE PROPERTY OF CARRIER CORPORATION. IT IS TO BE USED ONLY FOR THE EQUIPMENT AND IS NOT TO BE REPRODUCED OR TRANSMITTED IN ANY FORM OR BY ANY MEANS, ELECTRONIC OR MECHANICAL, INCLUDING PHOTOCOPYING, RECORDING, OR BY ANY INFORMATION STORAGE AND RETRIEVAL SYSTEM, WITHOUT THE WRITTEN CONSENT OF CARRIER CORPORATION.



CONNECTION SIZES	
A	1 3/8" [35] DIA. FIELD POWER SUPPLY HOLE
B	2" [50] DIA. POWER SUPPLY KNOCKOUT
C	1 3/4" [51] DIA. GAUGE ACCESS PLUG
D	7/8" [22] DIA. FIELD CONTROL WIRING HOLE
E	3/4" -14 NPT CONDENSATE DRAIN
F	1/2" -14 NPT GAS CONNECTION
G	2 1/2" [64] DIA. POWER SUPPLY KNOCK-OUT

THRU-THE-BASE CHART THESE HOLES REQUIRED FOR USE CEBTIPWR008A00 - 009A00	
W	1/2" [12.7] WIRE USE 7/8" [22.2]
X	1/2" [12.7] WIRE USE 7/8" [22.2]
Y	3/4" [19.0] POWER 1-1/8" [28.6]
Z*	1/2" [12.7] GAS 1-1/8" [28.6]

* FOR "THRU-THE-BASEPAN" FACTORY OPTION, FITTINGS FOR ONLY X, Y, & Z ARE PROVIDED. (008A00) PROVIDES 3/4" FPT THRU CURB FLANGE & FITTING.

UNIT	J	K	R
48GC**04	33 3/8 [847]	18 5/8 [472]	18 5/8 [472]
48GC**05	33 3/8 [847]	18 5/8 [472]	18 5/8 [472]
48GC**06	41 3/8 [1051]	18 5/8 [472]	18 5/8 [472]

- NOTES:
1. DIMENSIONS ARE IN INCHES, DIMENSIONS IN [] ARE IN MILLIMETERS.
 2. CENTER OF GRAVITY
 3. DIRECTION OF AIR FLOW
 4. ALL VIEW DRAWN USING 3RD ANGLE

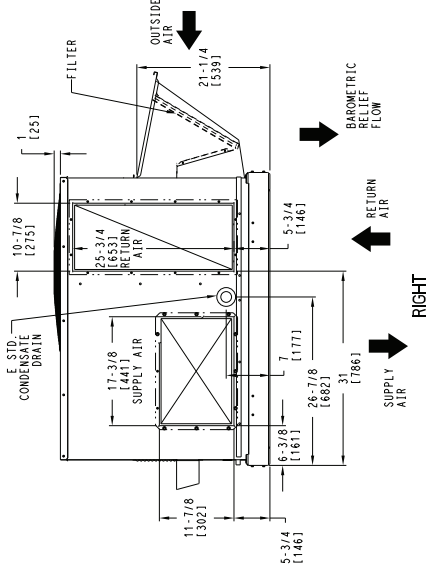
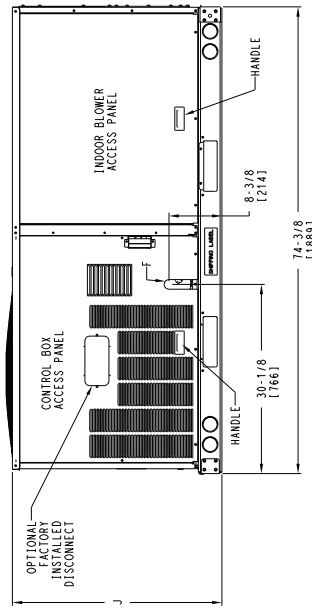
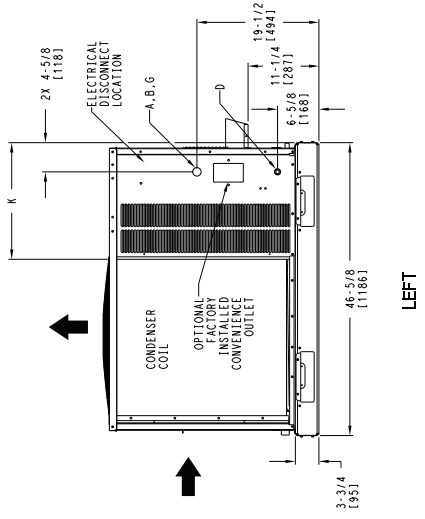
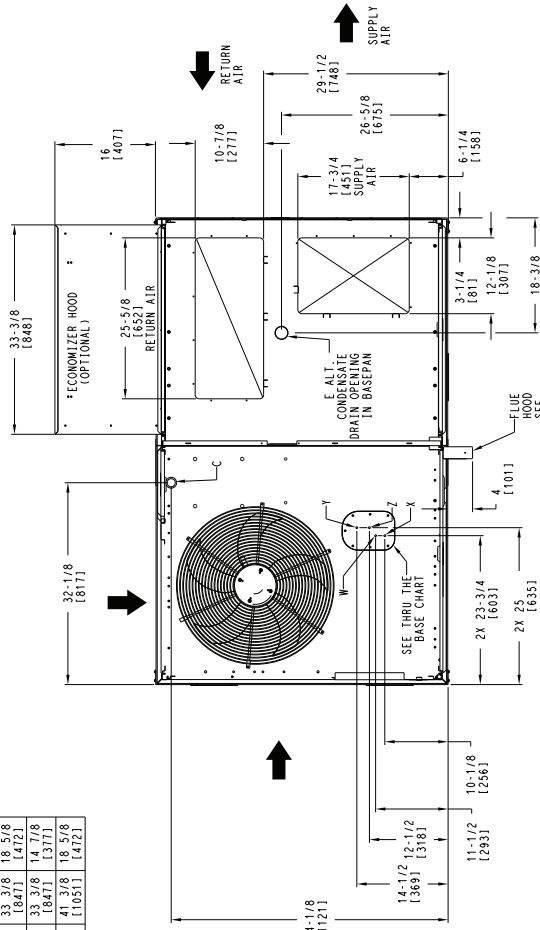
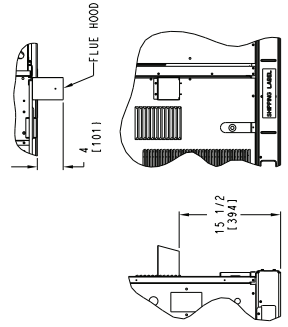

ITC CLASSIFICATION	SHEET	DATE	SUPERCEDES	REV
U.S. ECCN:NSR	1 OF 3	11/17/20	48GC 04-06 SINGLE PACKAGE ELECTRICAL COOLING WITH GAS HEAT	E

Base unit dimensions (cont)



48GC**04-06 BASE UNIT DIMENSIONS (cont)

THIS DOCUMENT IS THE PROPERTY OF CARRIER CORPORATION AND IS DELIVERED UNDER THE EXPRESS CONDITION THAT THE USER SHALL NOT REPRODUCE OR USE WITHOUT CARRIER CORPORATION'S WRITTEN CONSENT.

UNIT	CORNER WEIGHT (A)		CORNER WEIGHT (B)		CORNER WEIGHT (C)		CORNER WEIGHT (D)		C.G.			HEIGHT	
	LBS.	KG.	LBS.	KG.	LBS.	KG.	LBS.	KG.	X	Y	Z		
48GC**04	513	233	131	59	127	58	125	57	130	59	36 1/2 [927]	23 1/4 [591]	18 1/4 [464]
48GC**05	555	252	142	64	137	62	135	61	141	64	36 1/2 [927]	23 1/4 [591]	18 [457]
48GC**06	600	272	161	73	151	68	140	64	149	68	36 [914]	22 1/2 [572]	19 3/8 [492]

** STANDARD UNIT WEIGHT IS WITH LOW GAS HEAT AND WITHOUT PACKAGING. FOR OTHER OPTIONS AND ACCESSORIES REFER TO THE PRODUCT DATA CATALOG.

THIS TABLE IS FOR "ULTRA LOW NOX" UNITS ONLY

UNIT	CORNER WEIGHT (A)		CORNER WEIGHT (B)		CORNER WEIGHT (C)		CORNER WEIGHT (D)		C.G.			HEIGHT
	LBS.	KG.	LBS.	KG.	LBS.	KG.	LBS.	KG.	X	Y	Z	
48GC**04	543	247	139	63	133	60	139	63	36 3/8 [924]	23 3/8 [594]	18 [457]	
48GC**05	585	266	149	68	143	65	149	68	36 3/8 [924]	23 3/8 [594]	18 [457]	
48GC**06	630	286	168	76	157	71	147	69	35 7/8 [911]	22 5/8 [575]	19 1/2 [489]	

*** STANDARD UNIT WEIGHT IS WITHOUT PACKAGING. FOR OTHER OPTIONS AND ACCESSORIES REFER TO THE PRODUCT DATA CATALOG.

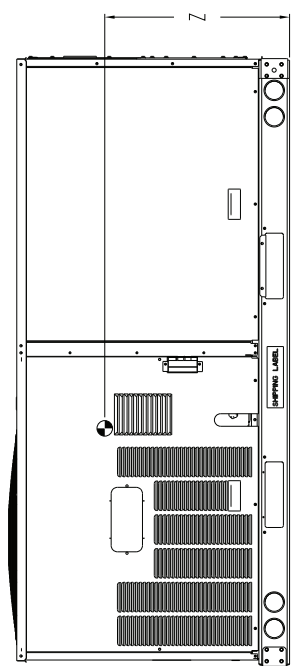
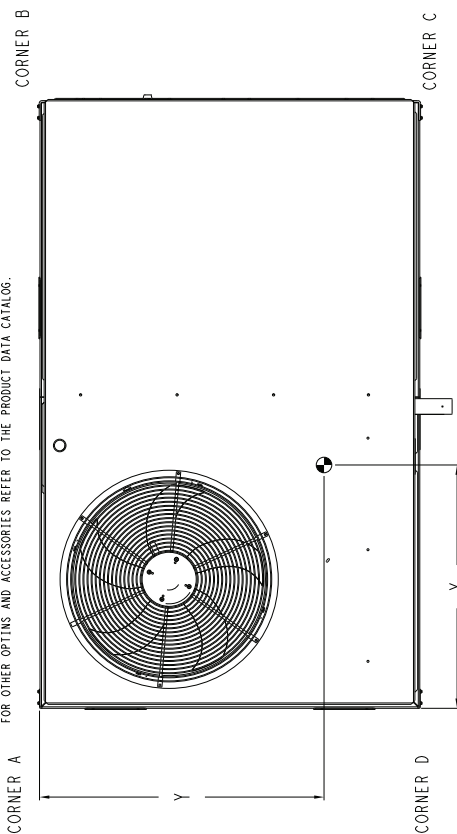
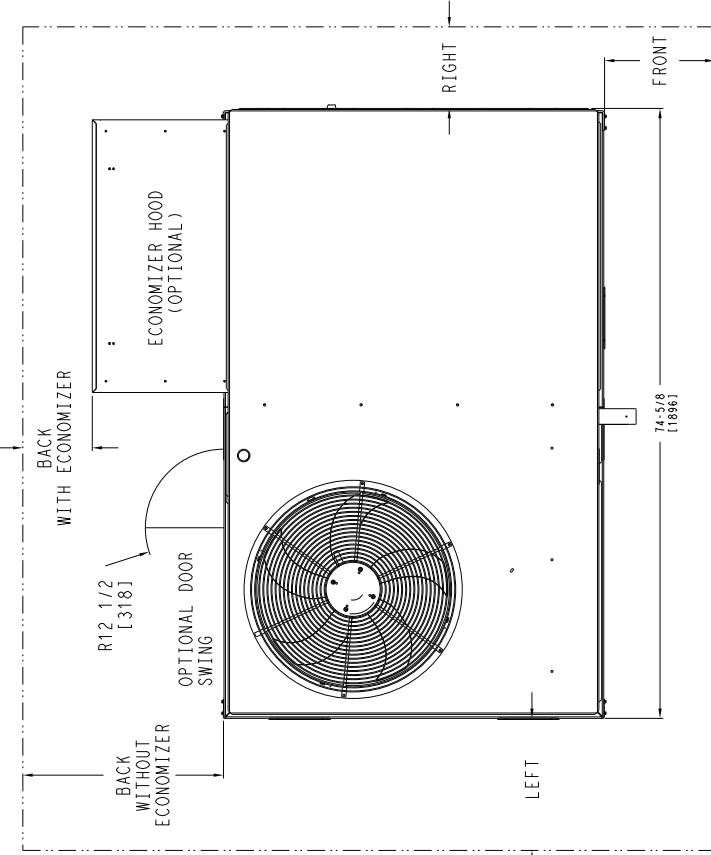

NOTES:
1. FOR ALL MINIMUM CLEARANCES LOCAL CODES OR JURISDICTIONS MAY PREVAIL.

SURFACE	CLEARANCE		
	SERVICE WITH CONDUCTIVE BARRIER	SERVICE WITH NONCONDUCTIVE BARRIER	OPERATING CLEARANCE
FRONT	48 [1219mm]	36 [914mm]	18 [457mm]
LEFT	48 [1219mm]	42 [1067mm]	18 [457mm]
BACK W/O HOOD	48 [1219mm]	42 [1067mm]	18 [457mm]
BACK W/HOOD	36 [914mm]	36 [914mm]	18 [457mm]
RIGHT	36 [914mm]	36 [914mm]	18 [457mm]
TOP	72 [1829mm]	72 [1829mm]	72 [1829mm]

ITC CLASSIFICATION	SHEET	DATE	REV
U.S. - ECCN: NSR	2 OF 3	11/17/20	E
SUPERCEDES	486C 04-06 SINGLE PACKAGE ELECTRICAL COOLING WITH GAS HEAT	48TC003099	

Base unit dimensions (cont)



48GC**04-06 BASE UNIT DIMENSIONS (cont)

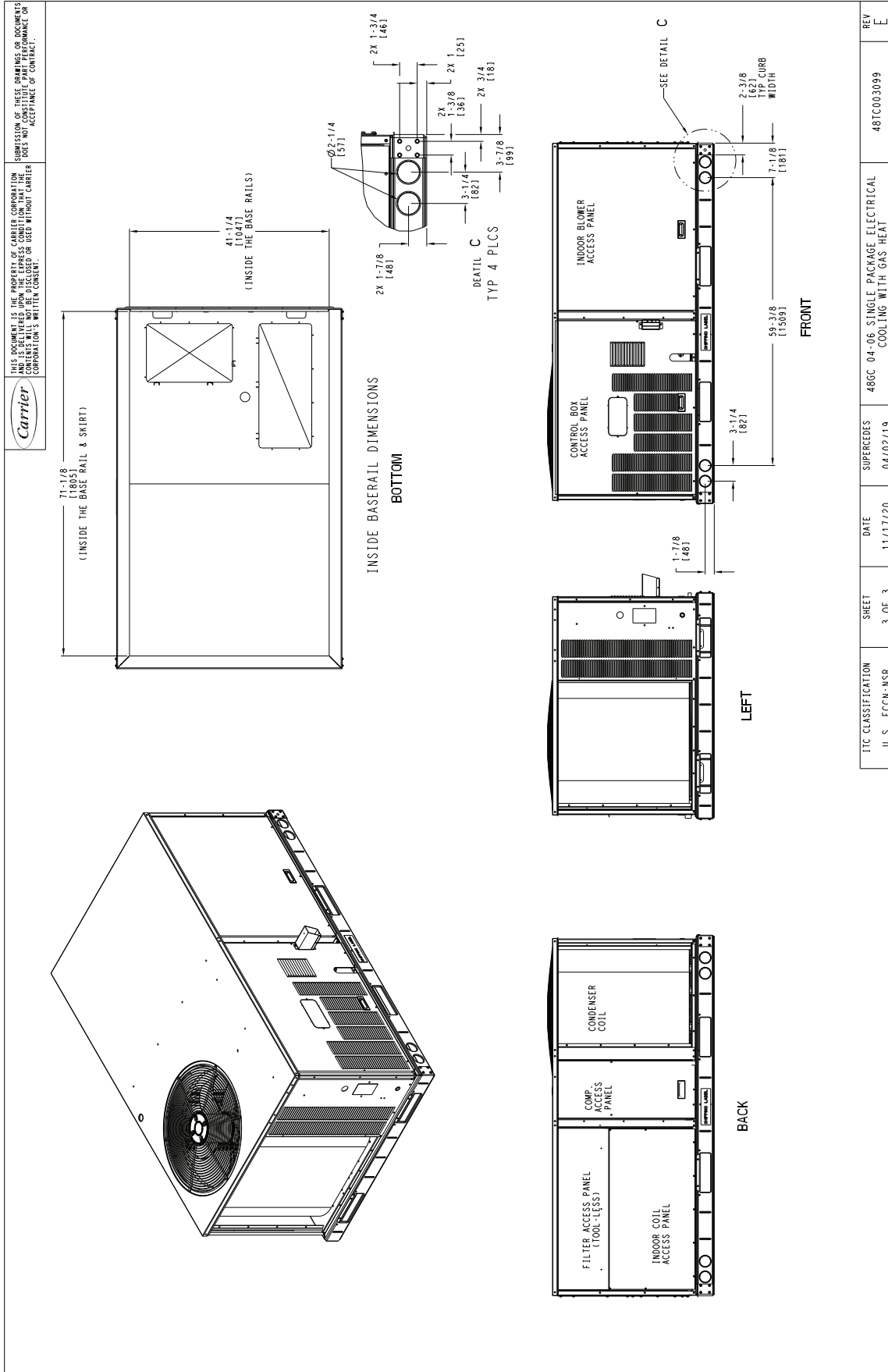

50GC-04-06 BASE UNIT DIMENSIONS

- NOTES:
1. DIMENSIONS ARE IN INCHES. DIMENSIONS IN [] ARE IN MILLIMETERS.
 2. CENTER OF GRAVITY
 3. DIRECTION OF AIR FLOW
 4. ALL VIEW DRAWN USING 3RD ANGLE

UNIT	J	K
50GC**04	33-3/8 [848]	18-7/8 [471]
50GC**05	33-5/8 [847]	14-7/8 [377]
50GC**06	41-3/8 [1051]	18-5/8 [472]



THIS DOCUMENT IS THE PROPERTY OF UTC CLIMATE CONTROLS. DISSEMINATION OF THESE DRAWINGS OR REVISIONS TO THESE DRAWINGS WITHOUT THE EXPRESS WRITTEN PERMISSION OF UTC CLIMATE CONTROLS IS PROHIBITED. THIS DOCUMENT DOES NOT CONSTITUTE A CONTRACT. PERFORMANCE OR WARRANTY SHALL BE GOVERNED BY THE TERMS AND CONDITIONS OF THE CONTRACT.

CONNECTION SIZES	
A	1 3/8" [35] DIA. FIELD POWER SUPPLY HOLE
B	2" [51] DIA. POWER SUPPLY KNOCKOUT
C	1 3/4" [44] DIA. GAUGE ACCESS PLUG
D	7/8" [22] DIA. FIELD CONTROL WIRING HOLE
E	3/4" - 14 NPT CONDENSATE DRAIN
G	2 1/2" [64] DIA. POWER SUPPLY KNOCK-OUT

THRU-THE-BASE CHART THESE HOLES REQUIRED FOR USE	
W	1 1/2" [38] WIRE RECD HOLE (MAX. X)
X	2 1/2" [64] WIRE RECD HOLE (MAX. Y)
Y	3/4" [19] WIRE RECD HOLE (MAX. Z)
Z	1/2" [13] WIRE RECD HOLE (MAX. W)

FOR "THRU-THE-BASEPAN" FACTORY OPTION, FITTINGS FOR ONLY X, Y, & Z ARE PROVIDED

* SELECT EITHER 3/4" OR 1/2" FOR POWER, DEPENDING ON WIRE SIZE (008A00) PROVIDES 3/4" FPT THRU CURB FLANGE & FITTING.

**

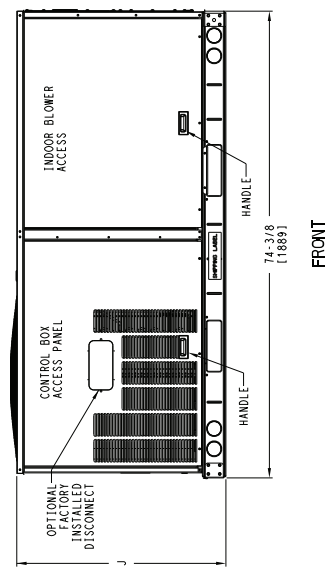
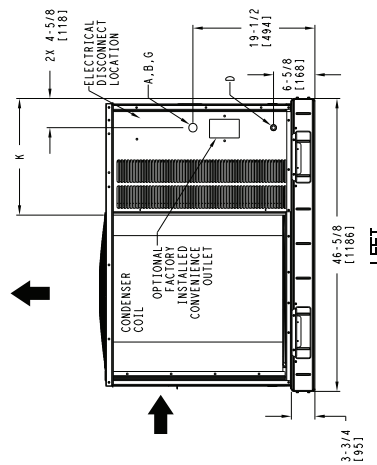
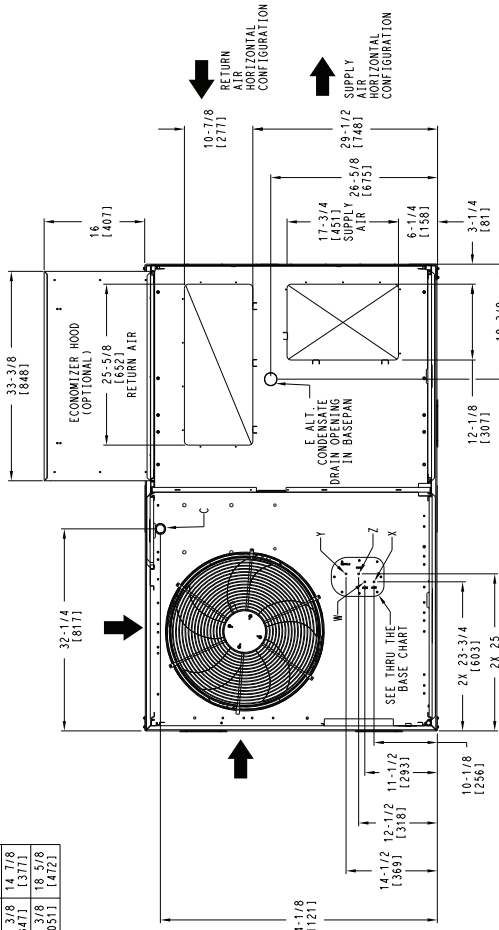

ITC CLASSIFICATION	SHEET	DATE	SUPERCEDES	50GC	04-06	SINGLE PACKAGE ELECTRICAL COOLING WITH ELECTRIC HEAT	REV
U.S. - ECCN: NSR	1 OF 3	03/21/19	10/25/18				D

Base unit dimensions (cont)



50GC-*04-06 BASE UNIT DIMENSIONS (cont)

Carrier
© United Technologies

THIS DOCUMENT IS THE PROPERTY OF THE CLIMATE CONTROLS DIVISION. SUBMISSION OF THESE DRAWINGS OR DOCUMENTS TO ANY OTHER PARTY WITHOUT THE WRITER'S CONSENT IS PROHIBITED. THE WRITER ASSUMES NO LIABILITY FOR PERFORMANCE OR ACCEPTANCE OF CONTRACT.

UNIT	STD. WEIGHT *		CORNER WEIGHT (A)		CORNER WEIGHT (B)		CORNER WEIGHT (C)		CORNER WEIGHT (D)		C. G.			HEIGHT					
	LBS.	KG.	LBS.	KG.	LBS.	KG.	LBS.	KG.	LBS.	KG.	X	Y	Z						
50GC**04	468	212	128	58	117	53	106	48	116	53	35	172	19021	22	1/4	15651	18	3/8	14671
50GC**05	510	231	140	64	128	58	116	53	127	58	35	172	19021	22	1/4	15651	18	3/8	14671
50GC**06	555	252	152	69	135	61	126	57	141	64	35	18891	22	1/2	15121	19	1/2	14951	

* STANDARD UNIT WEIGHT IS WITHOUT ELECTRIC HEAT AND WITHOUT PACKAGING.
FOR OTHER OPTIONS AND ACCESSORIES REFER TO THE PRODUCT DATA CATALOG.

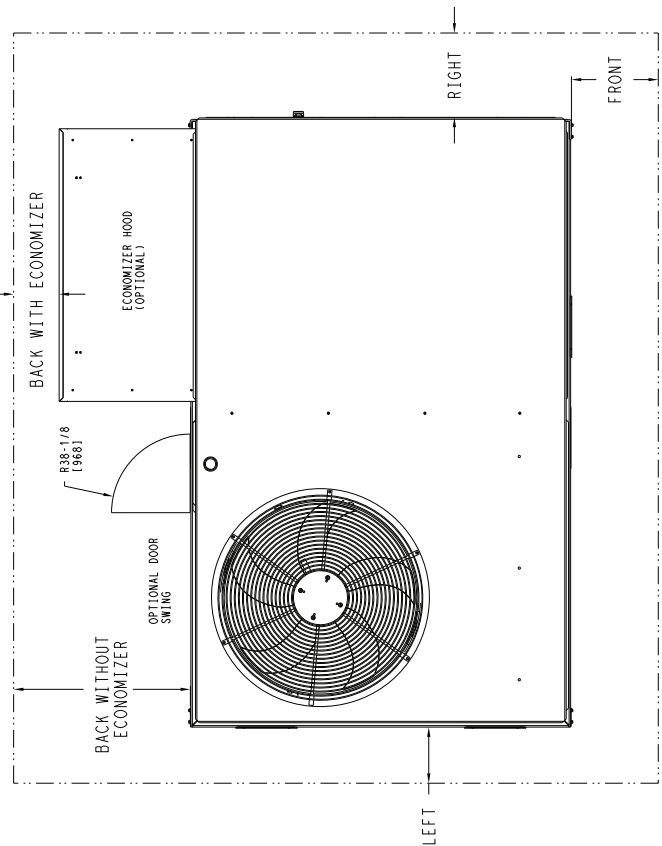
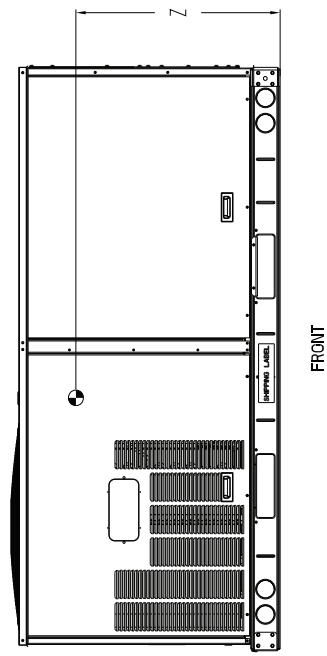
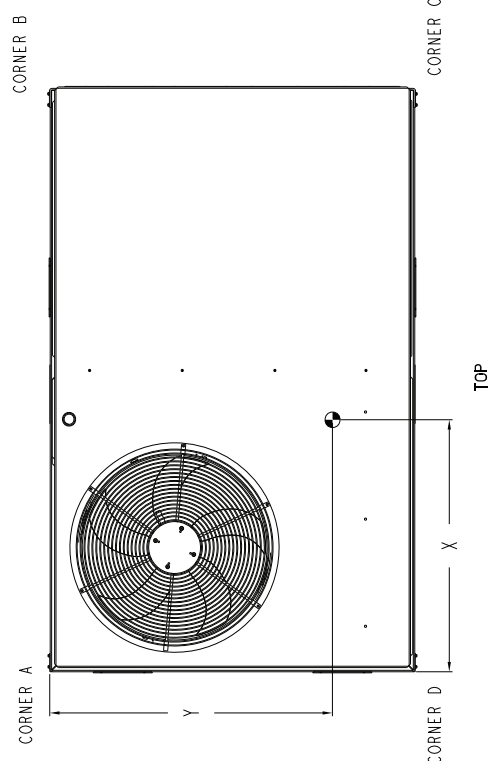

NOTE:
1. FOR ALL MINIMUM CLEARANCES LOCAL CODES OR JURISDICTIONS MAY PREVAIL.

SURFACE	CLEARANCE		OPERATING CLEARANCE	
	SERVICE WITH CONDUCTIVE BARRIER	NONCONDUCTIVE BARRIER	SERVICE WITH CONDUCTIVE BARRIER	NONCONDUCTIVE BARRIER
FRONT	48 [1219mm]	36 [914mm]	18 [457mm]	18 [457mm]
LEFT	48 [1219mm]	42 [1067mm]	18 [457mm]	18 [457mm]
BACK W/O HOOD	48 [1219mm]	42 [1067mm]	18 [457mm]	18 [457mm]
BACK W/ HOOD	36 [914mm]	36 [914mm]	18 [457mm]	18 [457mm]
RIGHT	36 [914mm]	36 [914mm]	18 [457mm]	18 [457mm]
TOP	72 [1829mm]	72 [1829mm]	72 [1829mm]	72 [1829mm]

TIC CLASSIFICATION	SHEET	DATE	REV
U.S. ECCN: NSR	2 OF 3	03/21/19	D
50GC 04-06 SINGLE PACKAGE ELECTRICAL COOLING WITH ELECTRIC HEAT		48TC003100	

Base unit dimensions (cont)



50GC-*04-06 BASE UNIT DIMENSIONS (cont)

THIS DOCUMENT IS THE PROPERTY OF UTC CLIMATE CONTROLS. PERMISSION OF THESE DIMENSIONS OR DRAWINGS & SECURITY AND IS DELIVERED UNDER THE EXPRESS CONDITION THAT IT IS NOT TO BE REPRODUCED OR TRANSMITTED IN ANY FORM OR BY ANY MEANS, WITHOUT WRITTEN CONSENT.

THIS DOCUMENT IS THE PROPERTY OF UTC CLIMATE CONTROLS. PERMISSION OF THESE DIMENSIONS OR DRAWINGS & SECURITY AND IS DELIVERED UNDER THE EXPRESS CONDITION THAT IT IS NOT TO BE REPRODUCED OR TRANSMITTED IN ANY FORM OR BY ANY MEANS, WITHOUT WRITTEN CONSENT.

INSIDE BASERAIL DIMENSIONS
BOTTOM

71-1/8 [1805] (INSIDE THE BASE RAIL & SKIRT)

41-1/4 [1047] (INSIDE THE BASERAILS)

DETAIL C
TYP 4 PLCS

2X 1-7/8 [48] 2X 1-3/4 [46] 2X 1 [25] 3-1/4 [82] 2X 3/4 [18] 2X 1-3/8 [36] 3-7/8 [99]

LEFT

CONDENSER COIL

FRONT

CONTROL BOX ACCESS PANEL INDOOR BLOWER ACCESS PANEL

2X 1-7/8 [47.6] 3-1/4 [82.0] 99-3/8 [1305.0] 7-1/8 [180.7] 2-3/8 [61.5] TYP COIL WIDTH

RIGHT

CONDENSER COIL

BACK

FILTER ACCESS PANEL (TOOL-LESS) CONDENSER COIL INDOOR COIL ACCESS PANEL

ITC CLASSIFICATION	SHEET	DATE	SUPERCEDES	50GC 04-06 SINGLE PACKAGE ELECTRICAL COOLING WITH ELECTRIC HEAT	REV
U.S. - ECCN: NSR	3 OF 3	03/21/19	10/25/18	48TC003100	D

ROOF CURB DIMENSIONS — 48/50GC 04-06

ROOF CURB ACCESSORY #	A	CONNECTOR PKG. ACC.	GAS CONNECTION TYPE	GAS FITTING	POWER WIRING FITTING	CONTROL WIRING FITTING	ACCESSORY CONVENIENCE OUTLET WIRING CONNECTOR
CRRCURB001A01	14" [356]	CRBTMPWR001A01	THRU THE CURB	3/4" [19] NPT	3/4" [19] NPT	1/2" [12.7] NPT	1/2" [12.7] NPT
CRRCURB002A01	24" [610]	CRBTMPWR003A01	THRU THE BOTTOM	1/2" [12.7] NPT			

- NOTES:
 1. ROOF CURB ACCESSORY IS SHIPPED DISASSEMBLED.
 2. INSULATED PANELS: 25.4 [1] THK. POLYURETHANE FOAM, 44.5 [1.34] # DENSITY.
 3. DIMENSIONS IN [] ARE IN MILLIMETERS.
 4. ROOF CURB: 18 GAGE STEEL.
 5. EACH DUCT W/NAIL CURB: 18 GAGE STEEL. FLANGES OF DUCT REST ON CURB.
 6. SUPPLY AND RETURN AIR CURB: 18 GAGE STEEL. FLANGES OF DUCT REST ON CURB.
 7. DIRECTION OF AIR FLOW.
 8. CONNECTOR PACKAGE CRBTMPWR001A01 IS FOR THRU-THE-CURB GAS TYPE GAS CONNECTIONS. PACKAGE CRBTMPWR003A01 IS FOR THRU-THE-BOTTOM TYPE GAS CONNECTIONS.

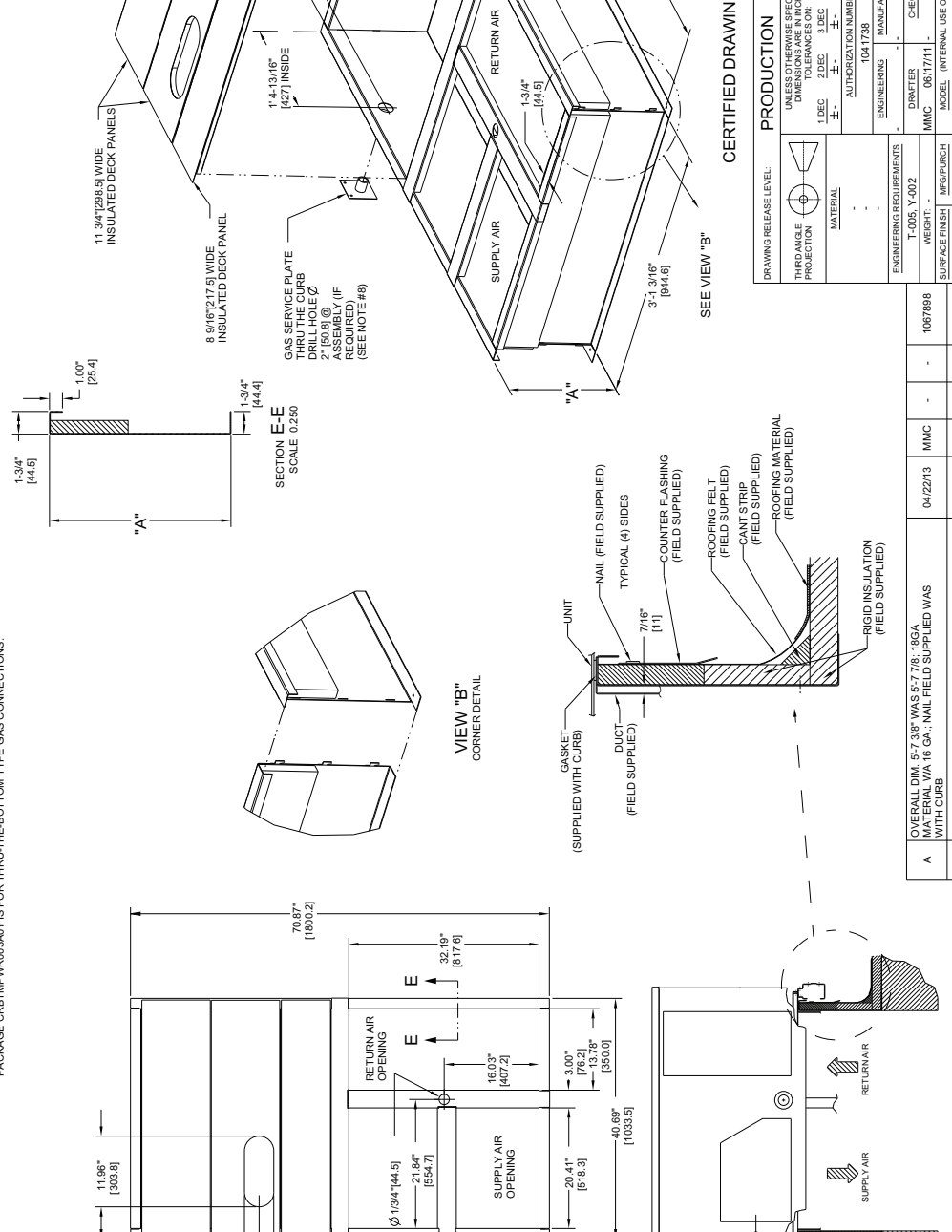

DRAWING RELEASE LEVEL:		PRODUCTION		TITLE	
THIRD ANGLE PROJECTION	UNLESS OTHERWISE SPECIFIED DIMENSIONS ARE IN INCHES TOLERANCES ON:	ENGINEERING	MANUFACTURING	SIZE	DRAWING NUMBER
	DEC ±.005	1041738		D	48TC400427
	FRA ±.005	DRAPFER	CHECKER	SCALE	DISTRIBUTION
	MIL ±.005	MMC	MM	NEXT DRAWING	N/A
	SURFACE FINISH	MODEL (INTERNAL USE ONLY)		SCALE	DISTRIBUTION
					MMC

REV	DATE	BY	CHKD	APPD	ECNO	REVISION RECORD
A	04/22/13	MMC			1087898	OVERALL DIM. 5'-7 3/8" WAS 5'-7 7/8" 18GA. W/NAIL FIELD SUPPLIED WAS WITH CURB

48/50GC**04 HIGH STAGE COOLING CAPACITIES

48/50GC**04				AMBIENT TEMPERATURE (F)												
				85			95			105			115			
				EAT (db)			EAT (db)			EAT (db)			EAT (db)			
				75	80	85	75	80	85	75	80	85	75	80	85	
900 Cfm	EAT (wb)	58	TC	29.3	29.3	33.4	27.3	27.3	31.3	25.2	25.2	29.1	23.0	23.0	26.6	
			SHC	25.1	29.3	33.4	23.3	27.3	31.3	21.4	25.2	29.1	19.3	23.0	26.6	
		62	TC	31.6	31.6	31.6	29.2	29.2	30.0	26.7	26.7	28.3	23.9	23.9	26.5	
			SHC	22.6	27.1	31.6	21.0	25.5	30.0	19.4	23.8	28.3	17.6	22.1	26.5	
		67	TC	35.5	35.5	35.5	33.0	33.0	33.0	30.3	30.3	30.3	27.3	27.3	27.3	
			SHC	18.7	23.2	27.7	17.1	21.6	26.1	15.5	20.0	24.4	13.8	18.2	22.7	
	72	TC	39.6	39.6	39.6	36.9	36.9	36.9	34.0	34.0	34.0	30.9	30.9	30.9		
		SHC	14.7	19.2	23.8	13.1	17.6	22.2	11.5	16.0	20.5	9.8	14.3	18.8		
	76	TC	—	43.1	43.1	—	40.2	40.2	—	37.2	37.2	—	33.9	33.9		
		SHC	—	16.0	20.9	—	14.4	19.3	—	12.8	17.6	—	11.1	15.8		
	1050 Cfm	EAT (wb)	58	TC	31.4	31.4	35.7	29.3	29.3	33.5	27.1	27.1	31.1	24.7	24.7	28.5
				SHC	27.0	31.4	35.7	25.1	29.3	33.5	23.0	27.1	31.1	20.8	24.7	28.5
62			TC	32.9	32.9	34.9	30.4	30.4	33.3	27.8	27.8	31.5	25.2	25.2	28.8	
			SHC	24.7	29.8	34.9	23.0	28.2	33.3	21.3	26.4	31.5	19.1	24.0	28.8	
67			TC	36.9	36.9	36.9	34.2	34.2	34.2	31.3	31.3	31.3	28.3	28.3	28.3	
			SHC	20.1	25.3	30.4	18.5	23.7	28.8	16.8	22.0	27.1	15.1	20.2	25.3	
72		TC	41.0	41.0	41.0	38.2	38.2	38.2	35.2	35.2	35.2	31.9	31.9	31.9		
		SHC	15.4	20.6	25.8	13.8	19.0	24.2	12.1	17.3	22.5	10.4	15.6	20.7		
76		TC	—	44.5	44.5	—	41.5	41.5	—	38.3	38.3	—	34.9	34.9		
		SHC	—	16.8	22.3	—	15.2	20.7	—	13.6	19.0	—	11.8	17.2		
1200 Cfm		EAT (wb)	58	TC	33.1	33.1	37.7	30.9	30.9	35.3	28.6	28.6	32.8	26.1	26.1	30.1
				SHC	28.5	33.1	37.7	26.5	30.9	35.3	24.4	28.6	32.8	22.1	26.1	30.1
	62		TC	34.0	34.0	38.0	31.4	31.4	36.2	29.4	29.4	31.6	26.8	26.8	29.2	
			SHC	26.6	32.3	38.0	24.8	30.5	36.2	21.8	26.7	31.6	19.8	24.5	29.2	
	67		TC	37.9	37.9	37.9	35.1	35.1	35.1	32.2	32.2	32.2	29.0	29.0	29.0	
			SHC	21.5	27.2	33.0	19.8	25.6	31.4	18.1	23.9	29.6	16.3	22.1	27.8	
	72	TC	42.1	42.1	42.1	39.1	39.1	39.1	36.0	36.0	36.0	32.7	32.7	32.7		
		SHC	16.1	21.9	27.8	14.4	20.3	26.1	12.7	18.6	24.4	11.0	16.8	22.6		
	76	TC	—	45.5	45.5	—	42.5	42.5	—	39.2	39.2	—	35.6	35.6		
		SHC	—	17.6	23.7	—	16.0	22.0	—	14.3	20.3	—	12.5	18.5		
	1350 Cfm	EAT (wb)	58	TC	34.6	34.6	39.3	32.3	32.3	36.9	29.9	29.9	34.2	27.3	27.3	31.4
				SHC	29.9	34.6	39.3	27.8	32.3	36.9	25.5	29.9	34.2	23.1	27.3	31.4
62			TC	35.3	35.3	38.8	33.0	33.0	36.2	30.5	30.5	33.4	27.3	27.3	32.8	
			SHC	27.4	33.1	38.8	25.2	30.7	36.2	23.0	28.2	33.4	21.8	27.3	32.8	
67			TC	38.7	38.7	38.7	35.9	35.9	35.9	32.9	32.9	32.9	29.6	29.6	30.2	
			SHC	22.7	29.1	35.5	21.0	27.4	33.8	19.3	25.7	32.1	17.4	23.8	30.2	
72		TC	42.9	42.9	42.9	39.9	39.9	39.9	36.7	36.7	36.7	33.2	33.2	33.2		
		SHC	16.7	23.1	29.6	15.0	21.4	27.9	13.3	19.7	26.1	11.5	17.9	24.3		
76		TC	—	46.4	46.4	—	43.2	43.2	—	39.8	39.8	—	36.2	36.2		
		SHC	—	18.3	25.0	—	16.6	23.3	—	14.9	21.5	—	13.1	19.7		
1500 Cfm		EAT (wb)	58	TC	29.3	29.3	33.4	27.3	27.3	31.3	25.2	25.2	29.1	23.0	23.0	26.6
				SHC	25.1	29.3	33.4	23.3	27.3	31.3	21.4	25.2	29.1	19.3	23.0	26.6
	62		TC	31.6	31.6	31.6	29.2	29.2	30.0	26.7	26.7	28.3	23.9	23.9	26.5	
			SHC	22.6	27.1	31.6	21.0	25.5	30.0	19.4	23.8	28.3	17.6	22.1	26.5	
	67		TC	35.5	35.5	35.5	33.0	33.0	33.0	30.3	30.3	30.3	27.3	27.3	27.3	
			SHC	18.7	23.2	27.7	17.1	21.6	26.1	15.5	20.0	24.4	13.8	18.2	22.7	
	72	TC	39.6	39.6	39.6	36.9	36.9	36.9	34.0	34.0	34.0	30.9	30.9	30.9		
		SHC	14.7	19.2	23.8	13.1	17.6	22.2	11.5	16.0	20.5	9.8	14.3	18.8		
	76	TC	—	43.1	43.1	—	40.2	40.2	—	37.2	37.2	—	33.9	33.9		
		SHC	—	16.0	20.9	—	14.4	19.3	—	12.8	17.6	—	11.1	15.8		

LEGEND

- Do Not Operate
- Cfm** — Cubic Feet Per Minute (Supply Air)
- EAT (db)** — Entering Air Temperature (dry bulb)
- EAT (wb)** — Entering Air Temperature (wet bulb)
- SHC** — Sensible Heat Capacity (1000 Btuh) Gross
- TC** — Total Capacity (1000 Btuh) Gross

NOTE: See minimum-maximum airflow ratings on page 8.

48/50GC**04 LOW STAGE COOLING CAPACITIES

48/50GC**04				AMBIENT TEMPERATURE (F)												
				85			95			105			115			
				EAT (db)			EAT (db)			EAT (db)			EAT (db)			
				75	80	85	75	80	85	75	80	85	75	80	85	
600 Cfm	EAT (wb)	58	TC	20.8	20.8	23.6	19.7	19.7	22.4	18.5	18.5	21.1	17.3	17.3	19.7	
			SHC	18.1	20.8	23.6	17.1	19.7	22.4	16.0	18.5	21.1	14.9	17.3	19.7	
		62	TC	22.3	22.3	22.5	20.9	20.9	21.7	19.4	19.4	20.8	17.7	17.7	19.9	
			SHC	16.4	19.4	22.5	15.6	18.6	21.7	14.8	17.8	20.8	13.9	16.9	19.9	
		67	TC	25.0	25.0	25.0	23.5	23.5	23.5	21.9	21.9	21.9	20.1	20.1	20.1	
			SHC	13.7	16.7	19.8	12.9	16.0	19.0	12.1	15.1	18.2	11.2	14.3	17.3	
	72	TC	27.9	27.9	27.9	26.3	26.3	26.3	24.6	24.6	24.6	22.7	22.7	22.7		
		SHC	10.9	14.0	17.1	10.1	13.2	16.3	9.3	12.4	15.5	8.5	11.5	14.6		
	76	TC	—	30.4	30.4	—	28.8	28.8	—	26.9	26.9	—	24.9	24.9		
		SHC	—	11.7	15.0	—	11.0	14.2	—	10.2	13.4	—	9.3	12.5		
	700 Cfm	EAT (wb)	58	TC	22.2	22.2	25.2	21.0	21.0	23.9	19.8	19.8	22.5	18.4	18.4	21.0
				SHC	19.3	22.2	25.2	18.2	21.0	23.9	17.1	19.8	22.5	15.9	18.4	21.0
62			TC	23.2	23.2	24.8	21.7	21.7	23.9	20.1	20.1	23.0	18.9	18.9	20.4	
			SHC	17.8	21.3	24.8	17.0	20.4	23.9	16.1	19.5	23.0	14.4	17.4	20.4	
67			TC	25.9	25.9	25.9	24.3	24.3	24.3	22.7	22.7	22.7	20.8	20.8	20.8	
			SHC	14.7	18.1	21.6	13.8	17.3	20.8	13.0	16.5	20.0	12.1	15.6	19.1	
72		TC	28.9	28.9	28.9	27.2	27.2	27.2	25.4	25.4	25.4	23.4	23.4	23.4		
		SHC	11.4	14.9	18.5	10.6	14.1	17.7	9.8	13.3	16.8	8.9	12.4	15.9		
76		TC	—	31.5	31.5	—	29.7	29.7	—	27.8	27.8	—	25.7	25.7		
		SHC	—	12.3	16.0	—	11.5	15.2	—	10.7	14.3	—	9.8	13.4		
800 Cfm		EAT (wb)	58	TC	23.4	23.4	26.5	22.2	22.2	25.1	20.8	20.8	23.6	19.4	19.4	22.1
				SHC	20.3	23.4	26.5	19.2	22.2	25.1	18.0	20.8	23.6	16.8	19.4	22.1
	62		TC	23.9	23.9	26.8	22.7	22.7	24.6	21.3	21.3	23.2	19.4	19.4	23.0	
			SHC	19.1	22.9	26.8	17.6	21.1	24.6	16.4	19.8	23.2	15.9	19.4	23.0	
	67		TC	26.7	26.7	26.7	25.0	25.0	25.0	23.3	23.3	23.3	21.3	21.3	21.3	
			SHC	15.5	19.5	23.4	14.7	18.6	22.6	13.8	17.8	21.7	12.9	16.9	20.8	
	72	TC	29.7	29.7	29.7	28.0	28.0	28.0	26.1	26.1	26.1	24.0	24.0	24.0		
		SHC	11.8	15.8	19.8	11.0	15.0	19.0	10.2	14.1	18.1	9.3	13.2	17.2		
	76	TC	—	32.3	32.3	—	30.5	30.5	—	28.4	28.4	—	26.3	26.3		
		SHC	—	12.8	16.9	—	12.0	16.1	—	11.2	15.2	—	10.3	14.3		
	900 Cfm	EAT (wb)	58	TC	24.4	24.4	27.6	23.1	23.1	26.2	21.7	21.7	24.7	20.2	20.2	23.0
				SHC	21.2	24.4	27.6	20.1	23.1	26.2	18.8	21.7	24.7	17.5	20.2	23.0
62			TC	25.0	25.0	26.8	23.6	23.6	25.4	21.8	21.8	25.7	20.2	20.2	23.9	
			SHC	19.3	23.1	26.8	18.2	21.8	25.4	17.9	21.8	25.7	16.6	20.2	23.9	
67			TC	27.3	27.3	27.3	25.6	25.6	25.6	23.7	23.7	23.7	21.8	21.8	22.5	
			SHC	16.3	20.7	25.1	15.5	19.9	24.3	14.6	19.0	23.4	13.7	18.1	22.5	
72		TC	30.3	30.3	30.3	28.5	28.5	28.5	26.6	26.6	26.6	24.5	24.5	24.5		
		SHC	12.2	16.6	21.0	11.4	15.8	20.2	10.5	14.9	19.3	9.6	14.0	18.4		
76		TC	—	33.0	33.0	—	31.1	31.1	—	29.0	29.0	—	26.7	26.7		
		SHC	—	13.3	17.8	—	12.5	17.0	—	11.6	16.1	—	10.7	15.2		
1000 Cfm		EAT (wb)	58	TC	25.3	25.3	28.6	24.0	24.0	27.1	22.5	22.5	25.5	20.9	20.9	23.8
				SHC	22.0	25.3	28.6	20.8	24.0	27.1	19.5	22.5	25.5	18.1	20.9	23.8
	62		TC	25.8	25.8	27.8	24.0	24.0	28.2	22.5	22.5	26.6	21.0	21.0	24.7	
			SHC	20.0	23.9	27.8	19.8	24.0	28.2	18.5	22.5	26.6	17.2	21.0	24.7	
	67		TC	27.7	27.7	27.7	26.0	26.0	26.0	24.1	24.1	25.0	22.1	22.1	24.0	
			SHC	17.1	21.9	26.7	16.3	21.1	25.9	15.4	20.2	25.0	14.4	19.2	24.0	
	72	TC	30.8	30.8	30.8	29.0	29.0	29.0	27.0	27.0	27.0	24.8	24.8	24.8		
		SHC	12.6	17.4	22.2	11.7	16.6	21.4	10.9	15.7	20.5	10.0	14.8	19.6		
	76	TC	—	33.5	33.5	—	31.5	31.5	—	29.4	29.4	—	27.1	27.1		
		SHC	—	13.7	18.7	—	12.9	17.8	—	12.0	16.9	—	11.1	16.0		

LEGEND

- Do Not Operate
- Cfm** — Cubic Feet Per Minute (Supply Air)
- EAT (db)** — Entering Air Temperature (dry bulb)
- EAT (wb)** — Entering Air Temperature (wet bulb)
- SHC** — Sensible Heat Capacity (1000 Btuh) Gross
- TC** — Total Capacity (1000 Btuh) Gross

NOTE: See minimum-maximum airflow ratings on page 8.

48/50GC*N04 — UNIT WITH HUMIDI-MIZER® SYSTEM IN SUBCOOLING MODE — COOLING CAPACITIES

TEMP (F) AIR ENTERING CONDENSER (Edb)		AIR ENTERING EVAPORATOR — SCFM/BF								
		900 / 0.01			1200 / 0.02			1500 / 0.04		
		Air Entering Evaporator — Ewb (F)								
		72	67	62	72	67	62	72	67	62
75	TC	44.4	40.1	36.3	46.8	42.7	38.9	48.6	44.1	40.6
	SHC	19.7	24.4	29.1	22.5	28.9	35.1	25.3	32.8	40.2
	kW	2.02	1.97	1.93	1.96	2.00	2.05	2.08	2.02	1.98
85	TC	41.9	37.9	34.2	44.4	40.3	36.7	45.8	41.7	38.4
	SHC	17.5	22.3	27.2	20.3	26.6	33.0	22.8	30.6	38.0
	kW	2.28	2.23	2.19	2.22	2.26	2.31	2.33	2.28	2.24
95	TC	39.4	35.6	32.1	41.6	37.8	34.3	43.0	39.1	36.0
	SHC	15.1	20.2	25.3	17.7	24.4	30.9	20.1	28.2	35.7
	kW	2.56	2.51	2.47	2.50	2.54	2.60	2.62	2.56	2.52
105	TC	36.6	33.1	29.9	38.7	35.1	31.9	40.0	36.3	33.4
	SHC	12.6	18.0	23.3	15.1	21.9	28.7	17.4	25.7	33.4
	kW	2.88	2.83	2.79	2.82	2.86	2.91	2.93	2.88	2.84
115	TC	33.7	30.4	27.4	35.6	32.3	29.2	36.8	33.3	30.7
	SHC	10.0	15.6	21.1	12.3	19.4	26.3	14.5	23.0	30.7
	kW	3.23	3.19	3.15	3.17	3.21	3.26	3.28	3.23	3.19
125	TC	30.6	27.5	24.8	32.3	29.2	26.4	33.3	30.2	27.8
	SHC	7.3	13.1	18.8	9.3	16.7	23.8	11.4	20.2	27.8
	kW	3.62	3.59	3.56	3.57	3.60	3.65	3.66	3.62	3.59

48/50GC*N04 — UNIT WITH HUMIDI-MIZER SYSTEM IN HOT GAS REHEAT MODE — COOLING CAPACITIES

TEMP (F) AIR ENTERING CONDENSER (Edb)		AIR ENTERING EVAPORATOR — Ewb (F)								
		75 Dry Bulb 62.5 Wet Bulb (50% Relative)			75 Dry Bulb 64 Wet Bulb (56% Relative)			75 Dry Bulb 65.3 Wet Bulb (60% Relative)		
		Air Entering Evaporator — Cfm								
		900	1200	1500	900	1200	1500	900	1200	1500
80	TC	13.33	13.89	14.37	13.49	13.96	14.41	13.65	14.37	14.82
	SHC	4.13	5.35	6.60	2.60	3.51	4.55	1.28	2.23	3.10
	kW	1.94	2.01	2.02	2.04	2.13	2.15	2.12	2.14	2.16
75	TC	13.45	14.19	14.65	13.91	14.65	15.12	14.33	15.08	15.55
	SHC	4.25	5.64	6.87	3.01	4.17	5.22	1.94	2.91	3.80
	kW	1.98	2.00	2.01	1.99	2.01	2.02	2.00	2.02	2.03
70	TC	13.77	14.63	15.09	14.22	14.95	15.72	14.91	15.67	16.29
	SHC	4.55	6.05	7.29	3.30	4.45	5.80	2.51	3.49	4.52
	kW	1.96	1.94	1.96	1.97	2.00	1.94	1.91	1.94	1.92
60	TC	14.28	14.98	15.69	14.72	15.70	16.16	15.11	15.81	16.57
	SHC	5.03	6.39	7.87	3.77	5.18	6.22	2.68	3.61	4.78
	kW	1.93	1.96	1.92	1.95	1.92	1.94	1.97	2.00	1.96
50	TC	14.43	15.06	15.98	14.83	15.98	16.41	15.19	16.37	16.79
	SHC	5.18	6.47	8.14	3.88	5.44	6.46	2.75	4.14	4.99
	kW	1.98	2.03	1.94	2.01	1.94	1.97	2.03	1.96	1.99
40	TC	14.34	15.70	16.08	15.47	16.44	16.48	15.82	16.81	17.22
	SHC	5.10	7.08	8.24	4.49	5.88	6.52	3.35	4.57	5.40
	kW	2.07	1.95	1.99	1.93	1.91	2.02	1.96	1.94	1.97

LEGEND

- Edb** — Entering Dry Bulb
- Ewb** — Entering Wet Bulb
- kW** — Compressor Power Input
- SCFM/BF** — Standard Cubic Feet per Minute/Bypass Factor
- SHC** — Sensible Heat Capacity (1000 Btuh) Gross
- TC** — Total Capacity (1000 Btuh) Gross

48/50GC**05 HIGH STAGE COOLING CAPACITIES

48/50GC**05				AMBIENT TEMPERATURE (F)												
				85			95			105			115			
				EAT (db)			EAT (db)			EAT (db)			EAT (db)			
				75	80	85	75	80	85	75	80	85	75	80	85	
1200 Cfm	EAT (wb)	58	TC	42.6	42.6	48.4	40.2	40.2	45.8	37.6	37.6	43.0	35.0	35.0	40.1	
			SHC	36.8	42.6	48.4	34.6	40.2	45.8	32.3	37.6	43.0	30.0	35.0	40.1	
		62	TC	45.7	45.7	45.7	42.6	42.6	43.6	39.5	39.5	41.7	36.3	36.3	39.8	
			SHC	33.0	39.2	45.4	31.2	37.4	43.6	29.3	35.5	41.7	27.5	33.6	39.8	
		67	TC	50.5	50.5	50.5	47.3	47.3	47.3	44.0	44.0	44.0	40.6	40.6	40.6	
			SHC	27.3	33.5	39.7	25.5	31.7	37.9	23.7	29.9	36.1	21.8	28.0	34.2	
	72	TC	55.7	55.7	55.7	52.3	52.3	52.3	48.7	48.7	48.7	45.1	45.1	45.1		
		SHC	21.3	27.6	33.9	19.6	25.8	32.1	17.8	24.0	30.3	16.0	22.2	28.4		
	76	TC	—	60.0	60.0	—	56.4	56.4	—	52.6	52.6	—	48.8	48.8		
		SHC	—	22.8	29.4	—	21.1	27.7	—	19.3	25.8	—	17.5	24.0		
	1400 Cfm	EAT (wb)	58	TC	45.3	45.3	51.4	42.7	42.7	48.6	40.0	40.0	45.6	37.2	37.2	42.6
				SHC	39.2	45.3	51.4	36.9	42.7	48.6	34.4	40.0	45.6	31.9	37.2	42.6
62			TC	47.3	47.3	50.1	44.1	44.1	48.1	40.9	40.9	46.1	37.6	37.6	43.9	
			SHC	35.8	43.0	50.1	33.9	41.0	48.1	32.0	39.0	46.1	29.9	36.9	43.9	
67			TC	52.2	52.2	52.2	48.8	48.8	48.8	45.3	45.3	45.3	41.8	41.8	41.8	
			SHC	29.2	36.3	43.5	27.3	34.5	41.6	25.4	32.6	39.7	23.6	30.7	37.8	
72		TC	57.4	57.4	57.4	53.8	53.8	53.8	50.1	50.1	50.1	46.3	46.3	46.3		
		SHC	22.2	29.4	36.7	20.4	27.6	34.8	18.6	25.8	33.0	16.7	23.9	31.1		
76		TC	—	61.6	61.6	—	57.9	57.9	—	54.0	54.0	—	50.0	50.0		
		SHC	—	23.9	31.4	—	22.1	29.6	—	20.3	27.7	—	18.4	25.8		
1600 Cfm		EAT (wb)	58	TC	47.6	47.6	54.0	44.8	44.8	50.9	42.0	42.0	47.8	39.0	39.0	44.6
				SHC	41.2	47.6	54.0	38.7	44.8	50.9	36.1	42.0	47.8	33.5	39.0	44.6
	62		TC	48.6	48.6	54.3	45.4	45.4	52.2	42.4	42.4	48.5	39.8	39.8	43.7	
			SHC	38.4	46.3	54.3	36.4	44.3	52.2	33.6	41.1	48.5	30.4	37.1	43.7	
	67		TC	53.5	53.5	53.5	50.0	50.0	50.0	46.3	46.3	46.3	42.7	42.7	42.7	
			SHC	30.9	38.9	47.0	29.0	37.1	45.1	27.1	35.1	43.2	25.2	33.2	41.3	
	72	TC	58.6	58.6	58.6	54.9	54.9	54.9	51.1	51.1	51.1	47.2	47.2	47.2		
		SHC	23.0	31.1	39.2	21.2	29.3	37.4	19.3	27.4	35.5	17.4	25.5	33.6		
	76	TC	—	62.9	62.9	—	59.0	59.0	—	55.0	55.0	—	51.0	51.0		
		SHC	—	24.8	33.2	—	23.0	31.3	—	21.1	29.4	—	19.3	27.5		
	1800 Cfm	EAT (wb)	58	TC	49.5	49.5	56.1	46.6	46.6	52.9	43.6	43.6	49.6	40.5	40.5	46.3
				SHC	42.9	49.5	56.1	40.3	46.6	52.9	37.6	43.6	49.6	34.8	40.5	46.3
62			TC	50.1	50.1	56.5	47.5	47.5	51.7	43.7	43.7	51.7	40.6	40.6	48.2	
			SHC	39.9	48.2	56.5	36.7	44.2	51.7	35.6	43.7	51.7	32.9	40.6	48.2	
67			TC	54.4	54.4	54.4	50.8	50.8	50.8	47.1	47.1	47.1	43.4	43.4	44.6	
			SHC	32.5	41.4	50.4	30.6	39.5	48.5	28.7	37.6	46.5	26.7	35.6	44.6	
72		TC	59.6	59.6	59.6	55.8	55.8	55.8	51.9	51.9	51.9	47.9	47.9	47.9		
		SHC	23.7	32.7	41.7	21.9	30.8	39.8	20.0	28.9	37.9	18.1	27.0	36.0		
76		TC	—	63.9	63.9	—	59.9	59.9	—	55.8	55.8	—	51.7	51.7		
		SHC	—	25.7	34.9	—	23.8	33.0	—	22.0	31.1	—	20.1	29.2		
2000 Cfm		EAT (wb)	58	TC	51.1	51.1	57.9	48.1	48.1	54.6	45.0	45.0	51.2	41.8	41.8	47.7
				SHC	44.3	51.1	57.9	41.6	48.1	54.6	38.8	45.0	51.2	36.0	41.8	47.7
	62		TC	52.0	52.0	56.4	48.1	48.1	56.8	45.0	45.0	53.3	41.9	41.9	49.7	
			SHC	40.3	48.3	56.4	39.5	48.1	56.8	36.8	45.0	53.3	34.0	41.9	49.7	
	67		TC	55.2	55.2	55.2	51.5	51.5	51.7	47.8	47.8	49.7	43.9	43.9	47.7	
			SHC	34.0	43.8	53.7	32.1	41.9	51.7	30.1	39.9	49.7	28.1	37.9	47.7	
	72	TC	60.4	60.4	60.4	56.5	56.5	56.5	52.5	52.5	52.5	48.5	48.5	48.5		
		SHC	24.3	34.2	44.1	22.5	32.3	42.2	20.6	30.4	40.2	18.7	28.5	38.3		
	76	TC	—	64.7	64.7	—	60.6	60.6	—	56.5	56.5	—	52.3	52.3		
		SHC	—	26.5	36.5	—	24.6	34.6	—	22.7	32.7	—	20.8	30.7		

LEGEND

- Do Not Operate
- Cfm** — Cubic Feet Per Minute (Supply Air)
- EAT (db)** — Entering Air Temperature (dry bulb)
- EAT (wb)** — Entering Air Temperature (wet bulb)
- SHC** — Sensible Heat Capacity (1000 Btuh) Gross
- TC** — Total Capacity (1000 Btuh) Gross

NOTE: See minimum-maximum airflow ratings on page 8.

48/50GC**05 LOW STAGE COOLING CAPACITIES

48/50GC**05				AMBIENT TEMPERATURE (F)												
				85			95			105			115			
				EAT (db)			EAT (db)			EAT (db)			EAT (db)			
				75	80	85	75	80	85	75	80	85	75	80	85	
900 Cfm	EAT (wb)	58	TC	30.3	30.3	34.3	28.5	28.5	32.4	26.6	26.6	30.2	24.5	24.5	27.9	
			SHC	26.2	30.3	34.3	24.6	28.5	32.4	22.9	26.6	30.2	21.0	24.5	27.9	
		62	TC	31.9	31.9	33.1	29.7	29.7	31.8	27.3	27.3	30.4	24.7	24.7	28.8	
			SHC	23.9	28.5	33.1	22.6	27.2	31.8	21.3	25.8	30.4	19.8	24.3	28.8	
		67	TC	35.6	35.6	35.6	33.2	33.2	33.2	30.7	30.7	30.7	28.0	28.0	28.0	
			SHC	19.7	24.3	28.9	18.5	23.1	27.7	17.2	21.8	26.4	15.8	20.4	25.0	
	72	TC	39.5	39.5	39.5	37.1	37.1	37.1	34.4	34.4	34.4	31.5	31.5	31.5		
		SHC	15.4	20.0	24.7	14.2	18.8	23.5	12.9	17.6	22.2	11.6	16.2	20.9		
	76	TC	—	42.9	42.9	—	40.4	40.4	—	37.6	37.6	—	34.6	34.6		
		SHC	—	16.6	21.5	—	15.4	20.3	—	14.2	19.0	—	12.9	17.6		
	1050 Cfm	EAT (wb)	58	TC	32.2	32.2	36.4	30.3	30.3	34.4	28.2	28.2	32.1	26.0	26.0	29.7
				SHC	27.9	32.2	36.4	26.2	30.3	34.4	24.4	28.2	32.1	22.4	26.0	29.7
62			TC	33.1	33.1	36.4	30.8	30.8	35.0	28.9	28.9	31.6	26.1	26.1	30.9	
			SHC	25.9	31.2	36.4	24.6	29.8	35.0	22.3	27.0	31.6	21.2	26.1	30.9	
67			TC	36.8	36.8	36.8	34.3	34.3	34.3	31.7	31.7	31.7	28.8	28.8	28.8	
			SHC	21.1	26.4	31.7	19.8	25.1	30.4	18.5	23.8	29.1	17.1	22.4	27.7	
72		TC	40.8	40.8	40.8	38.2	38.2	38.2	35.4	35.4	35.4	32.4	32.4	32.4		
		SHC	16.0	21.4	26.7	14.8	20.2	25.5	13.6	18.9	24.2	12.2	17.5	22.8		
76		TC	—	44.2	44.2	—	41.6	41.6	—	38.6	38.6	—	35.5	35.5		
		SHC	—	17.4	23.0	—	16.2	21.7	—	14.9	20.4	—	13.6	19.0		
1200 Cfm		EAT (wb)	58	TC	33.7	33.7	38.2	31.8	31.8	36.0	29.6	29.6	33.7	27.3	27.3	31.1
				SHC	29.3	33.7	38.2	27.5	31.8	36.0	25.6	29.6	33.7	23.5	27.3	31.1
	62		TC	34.5	34.5	37.7	32.3	32.3	36.0	29.7	29.7	35.1	27.4	27.4	32.4	
			SHC	26.9	32.3	37.7	25.4	30.7	36.0	24.3	29.7	35.1	22.3	27.4	32.4	
	67		TC	37.7	37.7	37.7	35.2	35.2	35.2	32.4	32.4	32.4	29.5	29.5	30.2	
			SHC	22.3	28.3	34.3	21.1	27.0	33.0	19.7	25.7	31.7	18.3	24.3	30.2	
	72	TC	41.8	41.8	41.8	39.1	39.1	39.1	36.2	36.2	36.2	33.2	33.2	33.2		
		SHC	16.6	22.7	28.7	15.4	21.4	27.4	14.1	20.1	26.1	12.7	18.7	24.7		
	76	TC	—	45.2	45.2	—	42.5	42.5	—	39.5	39.5	—	36.2	36.2		
		SHC	—	18.1	24.3	—	16.9	23.0	—	15.6	21.7	—	14.2	20.3		
	1350 Cfm	EAT (wb)	58	TC	35.1	35.1	39.7	33.0	33.0	37.5	30.8	30.8	35.0	28.4	28.4	32.3
				SHC	30.5	35.1	39.7	28.6	33.0	37.5	26.6	30.8	35.0	24.5	28.4	32.3
62			TC	35.7	35.7	39.3	33.1	33.1	39.0	30.8	30.8	36.4	28.4	28.4	33.7	
			SHC	28.0	33.6	39.3	27.2	33.1	39.0	25.3	30.8	36.4	23.2	28.4	33.7	
67			TC	38.4	38.4	38.4	35.8	35.8	35.8	33.0	33.0	34.1	30.0	30.0	32.6	
			SHC	23.5	30.2	36.8	22.3	28.9	35.5	20.9	27.5	34.1	19.4	26.0	32.6	
72		TC	42.5	42.5	42.5	39.8	39.8	39.8	36.9	36.9	36.9	33.7	33.7	33.7		
		SHC	17.2	23.8	30.5	15.9	22.6	29.2	14.6	21.3	27.9	13.2	19.8	26.5		
76		TC	—	46.0	46.0	—	43.2	43.2	—	40.1	40.1	—	36.8	36.8		
		SHC	—	18.7	25.6	—	17.5	24.3	—	16.2	22.9	—	14.8	21.5		
1500 Cfm		EAT (wb)	58	TC	36.3	36.3	41.0	34.1	34.1	38.7	31.8	31.8	36.1	29.4	29.4	33.4
				SHC	31.5	36.3	41.0	29.6	34.1	38.7	27.5	31.8	36.1	25.3	29.4	33.4
	62		TC	36.3	36.3	42.7	34.2	34.2	40.2	31.9	31.9	37.6	29.4	29.4	34.8	
			SHC	29.9	36.3	42.7	28.1	34.2	40.2	26.1	31.9	37.6	24.0	29.4	34.8	
	67		TC	39.0	39.0	39.3	36.3	36.3	37.9	33.5	33.5	36.5	30.4	30.4	34.9	
			SHC	24.7	32.0	39.3	23.4	30.6	37.9	22.0	29.2	36.5	20.5	27.7	34.9	
	72	TC	43.1	43.1	43.1	40.4	40.4	40.4	37.4	37.4	37.4	34.2	34.2	34.2		
		SHC	17.7	25.0	32.3	16.4	23.7	31.0	15.1	22.4	29.6	13.7	20.9	28.2		
	76	TC	—	46.7	46.7	—	43.8	43.8	—	40.7	40.7	—	37.3	37.3		
		SHC	—	19.4	26.8	—	18.1	25.5	—	16.8	24.1	—	15.4	22.6		

LEGEND

- Do Not Operate
- Cfm** — Cubic Feet Per Minute (Supply Air)
- EAT (db)** — Entering Air Temperature (dry bulb)
- EAT (wb)** — Entering Air Temperature (wet bulb)
- SHC** — Sensible Heat Capacity (1000 Btuh) Gross
- TC** — Total Capacity (1000 Btuh) Gross

NOTE: See minimum-maximum airflow ratings on page 8.

48/50GC*N05 — UNIT WITH HUMIDI-MIZER® SYSTEM IN SUBCOOLING MODE — COOLING CAPACITIES

TEMP (F) AIR ENTERING CONDENSER (Edb)		AIR ENTERING EVAPORATOR — SCFM/BF								
		1200 / 0.04			1600 / 0.07			2000 / 0.10		
		Air Entering Evaporator — Ewb (F)								
		72	67	62	72	67	62	72	67	62
75	TC	35.1	36.7	40.7	40.2	42.8	40.6	43.9	41.8	35.3
	SHC	16.2	21.3	31.2	31.0	24.0	16.7	15.9	22.1	26.6
	kW	3.06	3.07	3.06	3.44	3.43	3.41	3.84	3.82	3.72
85	TC	43.0	36.4	29.3	22.6	29.8	37.5	30.7	22.9	15.5
	SHC	12.9	17.4	21.3	15.4	11.6	7.7	2.0	5.7	9.1
	kW	4.28	4.20	4.05	4.77	4.57	4.42	5.17	4.99	4.81
95	TC	34.2	34.6	35.3	42.4	40.0	37.4	42.0	43.4	38.9
	SHC	16.1	20.7	27.4	36.3	23.6	16.1	16.2	25.8	33.9
	kW	3.25	3.25	3.24	3.63	3.63	3.61	4.04	4.02	4.00
105	TC	43.6	39.9	33.0	26.0	33.3	40.6	33.9	25.9	18.4
	SHC	14.9	22.7	28.6	22.4	17.0	11.0	5.0	10.5	15.7
	kW	4.49	4.47	4.32	4.99	4.87	4.69	5.50	5.28	5.09
115	TC	32.9	33.2	37.9	39.4	36.9	35.1	39.9	41.6	40.9
	SHC	15.4	20.1	30.9	34.4	22.1	15.1	15.7	25.9	39.2
	kW	3.53	3.51	3.46	3.89	3.89	3.88	4.31	4.30	4.26
125	TC	42.2	41.3	35.3	28.2	35.0	41.1	35.3	27.3	20.7
	SHC	15.2	26.5	34.3	27.8	21.3	12.8	7.3	14.6	20.7
	kW	4.78	4.75	4.65	5.28	5.24	5.00	5.83	5.63	5.41

48/50GC*N05 — UNIT WITH HUMIDI-MIZER SYSTEM IN HOT GAS REHEAT MODE — COOLING CAPACITIES

TEMP (F) AIR ENTERING CONDENSER (Edb)		AIR ENTERING EVAPORATOR — Ewb (F)								
		75 Dry Bulb 62.5 Wet Bulb (50% Relative)			75 Dry Bulb 64 Wet Bulb (56% Relative)			75 Dry Bulb 65.3 Wet Bulb (60% Relative)		
		Air Entering Evaporator — Cfm								
		1200	1600	2000	1200	1600	2000	1200	1600	2000
80	TC	14.91	15.96	16.62	15.48	16.57	17.21	16.00	17.09	17.86
	SHC	0.62	3.49	6.59	-1.56	0.81	3.43	-3.47	-1.53	0.79
	kW	2.66	2.68	2.69	2.67	2.69	2.69	2.68	2.69	2.68
75	TC	15.50	16.97	17.72	16.37	17.57	18.34	16.92	18.22	18.92
	SHC	1.19	4.42	7.59	-0.73	1.74	4.45	-2.61	-0.48	1.76
	kW	2.62	2.54	2.54	2.56	2.55	2.55	2.56	2.55	2.56
70	TC	15.94	17.30	18.11	16.61	18.01	18.89	17.36	18.71	19.41
	SHC	1.61	4.75	7.98	-0.49	2.16	4.98	-2.18	-0.02	2.22
	kW	2.60	2.56	2.54	2.58	2.54	2.53	2.54	2.52	2.54
60	TC	16.09	17.02	17.79	16.60	18.52	18.74	17.99	19.02	19.64
	SHC	1.79	4.56	7.76	-0.45	2.68	4.92	-1.56	0.32	2.50
	kW	2.69	2.74	2.73	2.72	2.58	2.68	2.56	2.60	2.63
50	TC	17.25	18.16	18.69	17.75	18.67	19.21	18.20	19.12	20.32
	SHC	2.88	5.62	8.61	0.63	2.86	5.38	-1.34	0.45	3.16
	kW	2.57	2.63	2.66	2.60	2.66	2.69	2.63	2.69	2.62
40	TC	17.33	18.59	19.23	18.21	19.06	20.45	18.62	19.47	20.91
	SHC	2.99	6.05	7.91	1.08	3.25	6.54	-0.92	0.81	3.74
	kW	2.64	2.64	2.69	2.61	2.67	2.58	2.64	2.70	2.61

LEGEND

- Edb** — Entering Dry Bulb
- Ewb** — Entering Wet Bulb
- kW** — Compressor Power Input
- SCFM/BF** — Standard Cubic Feet per Minute/Bypass Factor
- SHC** — Sensible Heat Capacity (1000 Btuh) Gross
- TC** — Total Capacity (1000 Btuh) Gross

48/50GC**06 HIGH STAGE COOLING CAPACITIES

48/50GC**06				AMBIENT TEMPERATURE (F)												
				85			95			105			115			
				EAT (db)			EAT (db)			EAT (db)			EAT (db)			
				75	80	85	75	80	85	75	80	85	75	80	85	
1500 Cfm	EAT (wb)	58	TC	54.4	54.4	61.6	51.9	51.9	58.8	49.1	49.1	55.8	46.1	46.1	52.4	
			SHC	47.2	54.4	61.6	44.9	51.9	58.8	42.4	49.1	55.8	39.8	46.1	52.4	
		62	TC	57.4	57.4	58.6	54.2	54.2	56.8	50.8	50.8	54.8	49.0	49.0	49.0	
			SHC	42.6	50.6	58.6	40.8	48.8	56.8	38.9	46.9	54.8	34.0	40.0	46.0	
		67	TC	63.3	63.3	63.3	59.9	59.9	59.9	56.2	56.2	56.2	52.1	52.1	52.1	
			SHC	35.1	43.1	51.1	33.3	41.3	49.3	31.5	39.4	47.4	29.5	37.5	45.4	
	72	TC	69.6	69.6	69.6	66.0	66.0	66.0	62.0	62.0	62.0	57.7	57.7	57.7		
		SHC	27.4	35.4	43.5	25.6	33.6	41.7	23.8	31.8	39.8	21.8	29.8	37.9		
	76	TC	—	75.1	75.1	—	71.2	71.2	—	67.0	67.0	—	62.4	62.4		
		SHC	—	29.1	37.4	—	27.4	35.7	—	25.6	33.8	—	23.7	31.9		
	1750 Cfm	EAT (wb)	58	TC	57.6	57.6	65.2	54.9	54.9	62.2	52.0	52.0	59.0	48.7	48.7	55.4
				SHC	50.0	57.6	65.2	47.6	54.9	62.2	45.0	52.0	59.0	42.1	48.7	55.4
62			TC	59.3	59.3	64.6	58.1	58.1	58.1	54.9	54.9	54.9	49.7	49.7	54.7	
			SHC	46.2	55.4	64.6	40.6	47.4	54.2	38.3	44.9	51.4	38.6	46.7	54.7	
67			TC	65.2	65.2	65.2	61.6	61.6	61.6	57.8	57.8	57.8	53.6	53.6	53.6	
			SHC	37.5	46.7	56.0	35.7	44.9	54.2	33.7	43.0	52.2	31.7	41.0	50.2	
72		TC	71.7	71.7	71.7	67.8	67.8	67.8	63.7	63.7	63.7	59.1	59.1	59.1		
		SHC	28.5	37.8	47.1	26.7	36.0	45.3	24.8	34.1	43.4	22.8	32.1	41.4		
76		TC	—	77.2	77.2	—	73.1	73.1	—	68.7	68.7	—	63.9	63.9		
		SHC	—	30.5	40.1	—	28.7	38.3	—	26.9	36.3	—	24.9	34.3		
2000 Cfm		EAT (wb)	58	TC	60.4	60.4	68.3	57.5	57.5	65.1	54.3	54.3	61.6	50.9	50.9	57.8
				SHC	52.4	60.4	68.3	49.8	57.5	65.1	47.1	54.3	61.6	44.0	50.9	57.8
	62		TC	63.4	63.4	63.4	59.9	59.9	59.9	54.4	54.4	64.1	51.0	51.0	60.2	
			SHC	44.8	52.2	59.6	43.4	51.2	59.0	44.7	54.4	64.1	41.7	51.0	60.2	
	67		TC	66.7	66.7	66.7	63.0	63.0	63.0	59.0	59.0	59.0	54.6	54.6	54.7	
			SHC	39.7	50.2	60.7	37.8	48.3	58.8	35.9	46.4	56.8	33.8	44.3	54.7	
	72	TC	73.3	73.3	73.3	69.3	69.3	69.3	64.9	64.9	64.9	60.3	60.3	60.3		
		SHC	29.4	40.0	50.5	27.6	38.2	48.7	25.7	36.2	46.7	23.7	34.2	44.7		
	76	TC	—	78.8	78.8	—	74.6	74.6	—	70.0	70.0	—	65.0	65.0		
		SHC	—	31.8	42.5	—	29.9	40.6	—	28.0	38.7	—	26.0	36.6		
	2250 Cfm	EAT (wb)	58	TC	62.7	62.7	70.9	59.6	59.6	67.5	56.3	56.3	63.9	52.7	52.7	59.9
				SHC	54.5	62.7	70.9	51.7	59.6	67.5	48.8	56.3	63.9	45.6	52.7	59.9
62			TC	63.8	63.8	69.8	59.7	59.7	70.2	56.4	56.4	66.4	52.8	52.8	62.3	
			SHC	50.0	59.9	69.8	49.2	59.7	70.2	46.3	56.4	66.4	43.3	52.8	62.3	
67			TC	67.9	67.9	67.9	64.1	64.1	64.1	59.9	59.9	61.3	55.5	55.5	59.1	
			SHC	41.8	53.5	65.2	39.9	51.6	63.3	37.9	49.6	61.3	35.8	47.5	59.1	
72		TC	74.5	74.5	74.5	70.4	70.4	70.4	65.9	65.9	65.9	61.2	61.2	61.2		
		SHC	30.4	42.1	53.8	28.5	40.2	51.9	26.6	38.3	50.0	24.6	36.2	47.9		
76		TC	—	80.1	80.1	—	75.8	75.8	—	71.0	71.0	—	65.9	65.9		
		SHC	—	32.9	44.8	—	31.1	42.9	—	29.1	40.9	—	27.0	38.7		
2500 Cfm		EAT (wb)	58	TC	64.6	64.6	73.1	61.5	61.5	69.6	58.0	58.0	65.7	54.3	54.3	61.6
				SHC	56.2	64.6	73.1	53.4	61.5	69.6	50.3	58.0	65.7	47.0	54.3	61.6
	62		TC	64.7	64.7	75.9	61.5	61.5	72.3	58.1	58.1	68.4	54.3	54.3	64.1	
			SHC	53.4	64.7	75.9	50.7	61.5	72.3	47.8	58.1	68.4	44.6	54.3	64.1	
	67		TC	68.8	68.8	69.5	64.9	64.9	67.6	60.7	60.7	65.5	56.2	56.2	63.3	
			SHC	43.8	56.7	69.5	41.9	54.7	67.6	39.9	52.7	65.5	37.8	50.5	63.3	
	72	TC	75.5	75.5	75.5	71.3	71.3	71.3	66.7	66.7	66.7	61.9	61.9	61.9		
		SHC	31.2	44.1	57.0	29.4	42.2	55.1	27.4	40.3	53.1	25.4	38.2	51.0		
	76	TC	—	81.2	81.2	—	76.7	76.7	—	71.8	71.8	—	66.6	66.6		
		SHC	—	34.0	47.0	—	32.1	45.0	—	30.1	42.9	—	28.0	40.7		

LEGEND

- Do Not Operate
- Cfm** — Cubic Feet Per Minute (Supply Air)
- EAT (db)** — Entering Air Temperature (dry bulb)
- EAT (wb)** — Entering Air Temperature (wet bulb)
- SHC** — Sensible Heat Capacity (1000 Btuh) Gross
- TC** — Total Capacity (1000 Btuh) Gross

NOTE: See minimum-maximum airflow ratings on page 8.

48/50GC**06 LOW STAGE COOLING CAPACITIES

48/50GC**06				AMBIENT TEMPERATURE (F)												
				85			95			105			115			
				EAT (db)			EAT (db)			EAT (db)			EAT (db)			
				75	80	85	75	80	85	75	80	85	75	80	85	
1000 Cfm	EAT (wb)	58	TC	35.3	35.3	40.2	32.8	32.8	37.5	30.1	30.1	34.5	27.3	27.3	31.4	
			SHC	30.4	35.3	40.2	28.2	32.8	37.5	25.7	30.1	34.5	23.2	27.3	31.4	
		62	TC	37.6	37.6	38.3	34.5	34.5	36.4	31.1	31.1	34.5	28.9	28.9	29.5	
			SHC	27.4	32.8	38.3	25.6	31.0	36.4	23.7	29.1	34.5	20.5	25.0	29.5	
		67	TC	42.2	42.2	42.2	38.9	38.9	38.9	35.4	35.4	35.4	31.7	31.7	31.7	
			SHC	22.6	28.1	33.5	20.8	26.2	31.7	18.9	24.4	29.8	17.0	22.4	27.8	
	72	TC	47.1	47.1	47.1	43.7	43.7	43.7	40.0	40.0	40.0	36.0	36.0	36.0		
		SHC	17.7	23.1	28.6	15.9	21.3	26.8	14.1	19.5	24.9	12.1	17.6	23.0		
	76	TC	—	51.2	51.2	—	47.7	47.7	—	43.8	43.8	—	39.7	39.7		
		SHC	—	19.0	24.5	—	17.3	22.8	—	15.5	21.0	—	13.6	19.1		
	1150 Cfm	EAT (wb)	58	TC	37.6	37.6	42.7	34.9	34.9	39.8	32.1	32.1	36.7	29.1	29.1	33.4
				SHC	32.4	37.6	42.7	30.0	34.9	39.8	27.4	32.1	36.7	24.7	29.1	33.4
62			TC	38.9	38.9	42.1	35.7	35.7	40.2	32.3	32.3	38.1	29.1	29.1	34.9	
			SHC	29.7	35.9	42.1	27.9	34.0	40.2	25.8	31.9	38.1	23.3	29.1	34.9	
67			TC	43.6	43.6	43.6	40.1	40.1	40.1	36.5	36.5	36.5	32.6	32.6	32.6	
			SHC	24.2	30.3	36.5	22.3	28.5	34.7	20.4	26.6	32.8	18.4	24.6	30.8	
72		TC	48.5	48.5	48.5	44.9	44.9	44.9	41.1	41.1	41.1	37.0	37.0	37.0		
		SHC	18.4	24.6	30.8	16.6	22.8	29.0	14.7	20.9	27.1	12.7	19.0	25.2		
76		TC	—	52.6	52.6	—	49.1	49.1	—	45.0	45.0	—	40.7	40.7		
		SHC	—	19.9	26.2	—	17.8	23.4	—	16.3	22.6	—	14.4	20.7		
1350 Cfm		EAT (wb)	58	TC	40.0	40.0	45.4	37.2	37.2	42.4	34.2	34.2	39.1	31.0	31.0	35.5
				SHC	34.5	40.0	45.4	32.0	37.2	42.4	29.3	34.2	39.1	26.4	31.0	35.5
	62		TC	41.8	41.8	42.1	37.2	37.2	44.2	34.2	34.2	40.8	31.0	31.0	37.1	
			SHC	30.5	36.3	42.1	30.3	37.2	44.2	27.7	34.2	40.8	24.9	31.0	37.1	
	67		TC	44.8	44.8	44.8	41.3	41.3	41.3	37.5	37.5	37.5	33.4	33.4	34.5	
			SHC	26.0	33.2	40.4	24.1	31.3	38.6	22.1	29.4	36.6	20.1	27.3	34.5	
	72	TC	49.8	49.8	49.8	46.1	46.1	46.1	42.1	42.1	42.1	37.9	37.9	37.9		
		SHC	19.1	26.4	33.7	17.3	24.6	31.8	15.4	22.6	29.9	13.4	20.7	27.9		
	76	TC	—	54.0	54.0	—	50.1	50.1	—	46.0	46.0	—	41.6	41.6		
		SHC	—	20.8	28.2	—	19.1	26.5	—	17.2	24.5	—	15.2	22.6		
	1500 Cfm	EAT (wb)	58	TC	41.5	41.5	47.1	38.6	38.6	43.9	35.4	35.4	40.5	32.1	32.1	36.8
				SHC	35.8	41.5	47.1	33.2	38.6	43.9	30.4	35.4	40.5	27.4	32.1	36.8
62			TC	41.5	41.5	49.1	38.6	38.6	45.8	35.5	35.5	42.2	32.2	32.2	38.5	
			SHC	34.0	41.5	49.1	31.5	38.6	45.8	28.7	35.5	42.2	25.8	32.2	38.5	
67			TC	45.5	45.5	45.5	41.9	41.9	41.9	38.0	38.0	39.3	33.9	33.9	37.2	
			SHC	27.2	35.2	43.2	25.3	33.3	41.3	23.3	31.3	39.3	21.3	29.3	37.2	
72		TC	50.5	50.5	50.5	46.7	46.7	46.7	42.6	42.6	42.6	38.3	38.3	38.3		
		SHC	19.6	27.6	35.7	17.8	25.8	33.8	15.8	23.9	31.9	13.8	21.9	29.9		
76		TC	—	54.7	54.7	—	50.8	50.8	—	46.6	46.6	—	42.1	42.1		
		SHC	—	21.4	29.6	—	19.7	27.8	—	17.8	25.9	—	15.8	23.9		
1650 Cfm		EAT (wb)	58	TC	42.7	42.7	48.5	39.7	39.7	45.2	36.5	36.5	41.7	33.0	33.0	37.9
				SHC	36.9	42.7	48.5	34.2	39.7	45.2	31.3	36.5	41.7	28.2	33.0	37.9
	62		TC	42.8	42.8	50.5	39.8	39.8	47.1	36.5	36.5	43.4	33.1	33.1	39.5	
			SHC	35.0	42.8	50.5	32.4	39.8	47.1	29.6	36.5	43.4	26.6	33.1	39.5	
	67		TC	46.0	46.0	46.0	42.3	42.3	44.0	38.3	38.3	41.9	34.2	34.2	39.8	
			SHC	28.4	37.1	45.9	26.5	35.2	44.0	24.5	33.2	41.9	22.4	31.1	39.8	
	72	TC	51.0	51.0	51.0	47.1	47.1	47.1	42.9	42.9	42.9	38.6	38.6	38.6		
		SHC	20.0	28.8	37.6	18.1	26.9	35.7	16.2	25.0	33.8	14.2	23.0	31.7		
	76	TC	—	55.2	55.2	—	51.2	51.2	—	47.0	47.0	—	42.4	42.4		
		SHC	—	22.0	30.9	—	20.2	29.1	—	18.3	27.2	—	16.3	25.2		

LEGEND

- Do Not Operate
- Cfm** — Cubic Feet Per Minute (Supply Air)
- EAT (db)** — Entering Air Temperature (dry bulb)
- EAT (wb)** — Entering Air Temperature (wet bulb)
- SHC** — Sensible Heat Capacity (1000 Btuh) Gross
- TC** — Total Capacity (1000 Btuh) Gross

NOTE: See minimum-maximum airflow ratings on page 8.

48/50GC*N06 — UNIT WITH HUMIDI-MIZER® SYSTEM IN SUBCOOLING MODE — COOLING CAPACITIES

TEMP (F) AIR ENTERING CONDENSER (Edb)		AIR ENTERING EVAPORATOR — SCFM/BF								
		1500 / 0.01			2000 / 0.02			2500 / 0.03		
		Air Entering Evaporator — Ewb (F)								
		72	67	62	72	67	62	72	67	62
75	TC	67.6	60.9	55.4	71.7	65.0	59.2	74.2	67.6	62.2
	SHC	26.1	34.5	43.4	30.9	42.1	53.2	35.3	49.1	61.8
	kW	3.11	3.06	3.03	3.05	3.09	3.16	3.16	3.11	3.07
85	TC	63.0	57.1	51.7	67.0	60.7	55.3	68.8	62.9	58.1
	SHC	21.7	30.9	40.0	26.4	38.0	49.5	30.2	44.7	57.8
	kW	3.47	3.43	3.39	3.42	3.46	3.51	3.52	3.48	3.44
95	TC	58.4	52.8	47.8	61.9	56.1	51.1	64.1	58.2	53.7
	SHC	17.4	26.9	36.3	21.7	33.7	45.5	25.8	40.3	53.7
	kW	3.89	3.85	3.80	3.83	3.88	3.93	3.95	3.90	3.86
105	TC	53.4	48.0	43.3	55.9	50.5	45.8	58.6	52.7	48.4
	SHC	12.7	22.3	32.0	16.0	28.4	40.5	20.6	35.1	48.4
	kW	4.36	4.31	4.26	4.29	4.33	4.38	4.42	4.36	4.32
115	TC	47.9	43.2	39.0	50.6	45.6	41.5	52.4	47.6	43.8
	SHC	7.5	17.9	28.0	11.1	23.9	36.5	14.8	30.3	43.8
	kW	4.88	4.83	4.78	4.81	4.86	4.91	4.93	4.88	4.84
125	TC	42.0	37.9	34.1	44.5	40.1	36.1	46.3	41.7	38.4
	SHC	2.1	12.9	23.5	5.3	18.7	31.5	9.2	24.9	38.4
	kW	5.44	5.39	5.35	5.37	5.42	5.47	5.49	5.44	5.40

48/50GC*N06 — UNIT WITH HUMIDI-MIZER SYSTEM IN HOT GAS REHEAT MODE — COOLING CAPACITIES

TEMP (F) AIR ENTERING CONDENSER (Edb)		AIR ENTERING EVAPORATOR — Ewb (F)								
		75 Dry Bulb 62.5 Wet Bulb (50% Relative)			75 Dry Bulb 64 Wet Bulb (56% Relative)			75 Dry Bulb 65.3 Wet Bulb (60% Relative)		
		Air Entering Evaporator — Cfm								
		1500	2000	2500	1500	2000	2500	1500	2000	2500
80	TC	18.64	19.95	20.78	19.35	20.71	21.51	20.00	21.37	22.33
	SHC	0.78	4.36	8.24	-1.95	1.01	4.29	-4.33	-1.91	0.99
	kW	2.66	2.68	2.69	2.67	2.69	2.69	2.68	2.69	2.68
75	TC	19.37	21.21	22.15	20.47	21.97	22.92	21.15	22.78	23.65
	SHC	1.48	5.52	9.49	-0.91	2.18	5.57	-3.26	-0.61	2.20
	kW	2.62	2.54	2.54	2.56	2.55	2.55	2.56	2.55	2.56
70	TC	19.92	21.63	22.64	20.77	22.52	23.61	21.70	23.39	24.26
	SHC	2.01	5.94	9.98	-0.61	2.70	6.23	-2.72	-0.02	2.78
	kW	2.60	2.56	2.54	2.58	2.54	2.53	2.54	2.52	2.54
60	TC	20.11	21.27	22.23	20.75	23.15	23.43	22.49	23.78	24.55
	SHC	2.24	5.70	9.70	-0.57	3.35	6.15	-1.95	0.40	3.13
	kW	2.69	2.74	2.73	2.72	2.58	2.68	2.56	2.60	2.63
50	TC	21.56	22.70	23.37	22.18	23.33	24.01	22.75	23.90	25.40
	SHC	3.61	7.03	10.76	0.78	3.57	6.73	-1.67	0.57	3.96
	kW	2.57	2.63	2.66	2.60	2.66	2.69	2.63	2.69	2.62
40	TC	21.67	23.23	24.04	22.76	23.82	25.57	23.28	24.34	26.13
	SHC	3.74	7.56	9.89	1.35	4.06	8.17	-1.15	1.01	4.67
	kW	2.64	2.64	2.69	2.61	2.67	2.58	2.64	2.70	2.61

LEGEND

- Edb** — Entering Dry Bulb
- Ewb** — Entering Wet Bulb
- kW** — Compressor Power Input
- SCFM/BF** — Standard Cubic Feet per Minute/Bypass Factor
- SHC** — Sensible Heat Capacity (1000 Btuh) Gross
- TC** — Total Capacity (1000 Btuh) Gross

PRESSURE DROPS FOR GAS AND ELECTRIC HEATING UNITS

PRESSURE DROP FOR ELECTRIC HEAT 3 TON UNITS - 1 STAGE HEAT

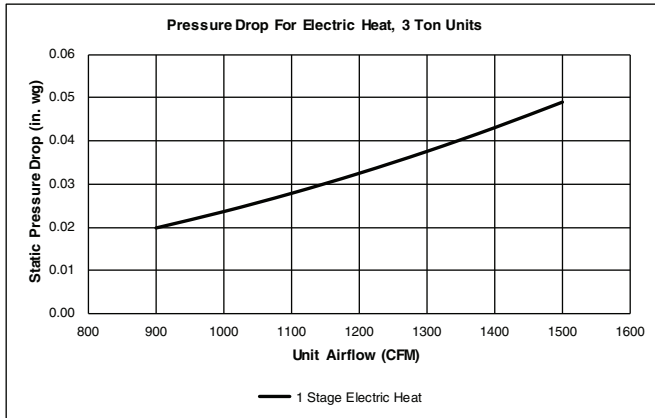

PRESSURE DROP FOR ELECTRIC HEAT 4 AND 5 TON UNITS - 1 AND 2 STAGE HEAT

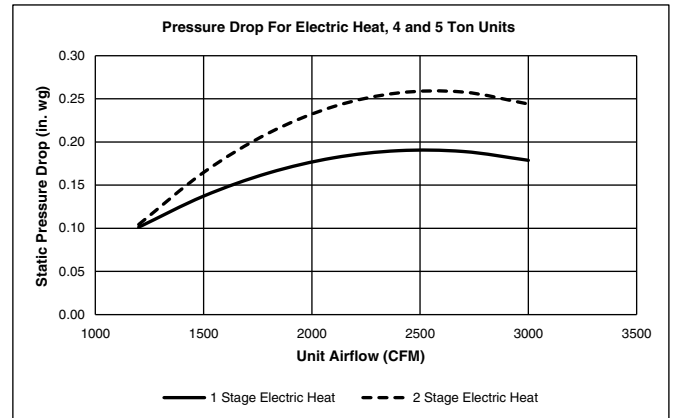

SINGLE PHASE GAS HEAT STAGES

UNIT SIZE	HEAT SIZE		
	Low	Med	High
1 Phase			
04	1	1	—
05	1	1	1
06	1	1	1

THREE PHASE GAS HEAT STAGES

UNIT SIZE	HEAT SIZE		
	Low	Med	High
3 Phase			
04	2	2	—
05	2	2	2
06	2	2	2

GAS HEAT STATIC PRESSURE DEDUCTIONS - 3 TON UNITS

CFM	900	1000	1100	1200	1300	1400	1500
Low Gas Heat	0.01	0.01	0.02	0.03	0.03	0.04	0.04

GAS HEAT STATIC PRESSURE DEDUCTIONS - 4 TO 5 TON UNITS

CFM	1200	1500	1800	2100	2400	2700	3000
Medium Gas Heat	0.01	0.05	0.08	0.12	0.15	0.18	0.20
Low Gas Heat	0.03	0.10	0.17	0.23	0.29	0.36	0.42

FACTORY-INSTALLED ELECTRIC HEAT STAGES FOR 50GC 208/230-3-60 VOLTAGE UNITS

UNIT SIZE	HEAT SIZE		
	Low	Medium	High
04	1	1	1
05	1	1	2
06	1	2	2

FACTORY-INSTALLED ELECTRIC HEAT STAGES FOR 50GC 460-3-60 VOLTAGE UNITS

UNIT SIZE	HEAT SIZE		
	Low	Medium	High
04	1	1	1
05	1	1	1
06	1	1	2

FACTORY-INSTALLED ELECTRIC HEATER STAGING DATA FOR 50GC UNITS

UNIT	VOLT-PH-HZ	HEAT SIZE	FIOP HEATER NO.	NOMINAL kW	STAGES
50GC**04	208/230-3-60	Low	CRHEATER323A00	4.4	1
		Medium	CRHEATER326A00	10.5	1
		High	CRHEATER328A00	15.5	1
	460-3-60	Low	CRHEATER333A00	6.0	1
		Medium	CRHEATER335A00	11.5	1
		High	CRHEATER336A00	14.0	1
50GC**05	208/230-3-60	Low	CRHEATER323A00	4.4	1
		Medium	CRHEATER326A00	10.5	1
		High	CRHEATER329A00	17.4	2
	460-3-60	Low	CRHEATER333A00	6.0	1
		Medium	CRHEATER335A00	11.5	1
		High	CRHEATER336A00	14.0	1
50GC**06	208/230-3-60	Low	CRHEATER324A00	6.5	1
		Medium	CRHEATER329A00	17.4	2
		High	CRHEATER332A00	24.5	2
	460-3-60	Low	CRHEATER333A00	6.0	1
		Medium	CRHEATER335A00	11.5	1
		High	CRHEATER338A00	24.0	2

FIELD-INSTALLED ACCESSORY ELECTRIC HEATER DATA

50GC UNIT SIZE	VOLTAGE	HEATER MODEL NUMBER*	NUMBER OF STAGES
04	208/230	CRHEATER323A00	1
		CRHEATER324A00	1
		CRHEATER325A00	1
		CRHEATER326A00	1
		CRHEATER327A00	2
		CRHEATER328A00	1
	460	CRHEATER333A00	1
		CRHEATER334A00	1
		CRHEATER335A00	1
		CRHEATER336A00	1
	575	CRHEATER339A00	1
		CRHEATER340A00	1
05	208/230	CRHEATER323A00	1
		CRHEATER324A00	1
		CRHEATER325A00	1
		CRHEATER326A00	1
		CRHEATER327A00	2
		CRHEATER328A00	1
		CRHEATER329A00	2
		CRHEATER330A00†	2
		CRHEATER331A00**	2
	460	CRHEATER333A00	1
		CRHEATER335A00	1
		CRHEATER336A00	1
		CRHEATER337A00	2
	575	CRHEATER339A00	1
		CRHEATER340A00	1
06	208/230	CRHEATER324A00	1
		CRHEATER325A00	1
		CRHEATER326A00	1
		CRHEATER327A00	2
		CRHEATER328A00	1
		CRHEATER329A00	2
		CRHEATER331A00	2
		CRHEATER332A00	2
	460	CRHEATER333A00	1
		CRHEATER335A00	1
		CRHEATER336A00	1
		CRHEATER337A00	2
	575	CRHEATER338A00	2
		CRHEATER340A00	1
		CRHEATER341A00	2

*Check heater nameplate for model number.

**Do not use with size 05 vertical supply duct configuration units.

†Do not use with size 05 horizontal supply duct configuration units.

USE OF CRHEATER330A00 FOR 50GC UNITS (WITH OR WITHOUT NON-FUSED DISCONNECT)

DUCT CONFIGURATION	50GC UNIT SIZE		
	04	05	06
Vertical Supply	Not available	Available	Not available
Horizontal Supply	Not available	Not available	Not available

USE OF CRHEATER331A00 FOR 50GC UNITS (WITH OR WITHOUT NON-FUSED DISCONNECT)

DUCT CONFIGURATION	50GC UNIT SIZE		
	04	05	06
Vertical Supply	Not available	Not available	Available
Horizontal Supply	Not available	Available	Available

ECONOMIZER BAROMETRIC RELIEF AND STATIC PRESSURE

HORIZONTAL ECONOMIZER BAROMETRIC RELIEF

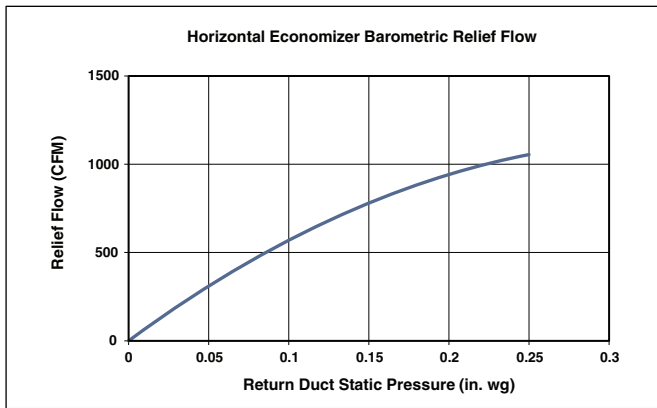

VERTICAL ECONOMIZER BAROMETRIC RELIEF

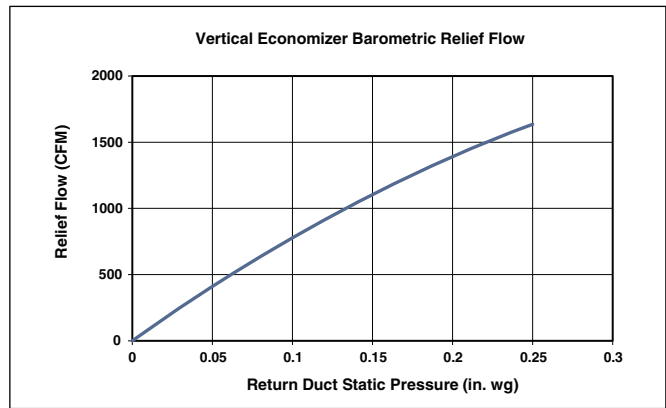

HORIZONTAL ECONOMIZER DAMPER LEAKAGE

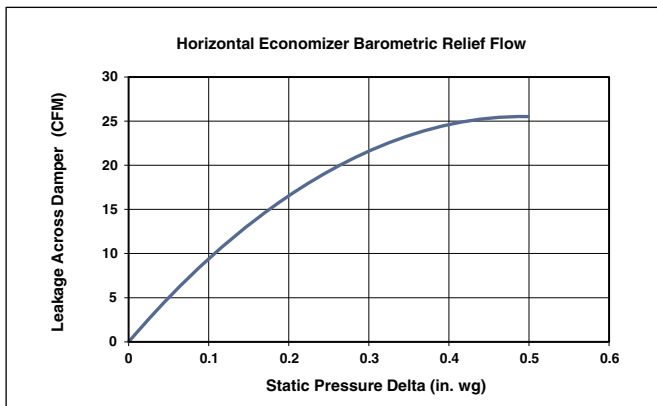

VERTICAL ECONOMIZER DAMPER LEAKAGE

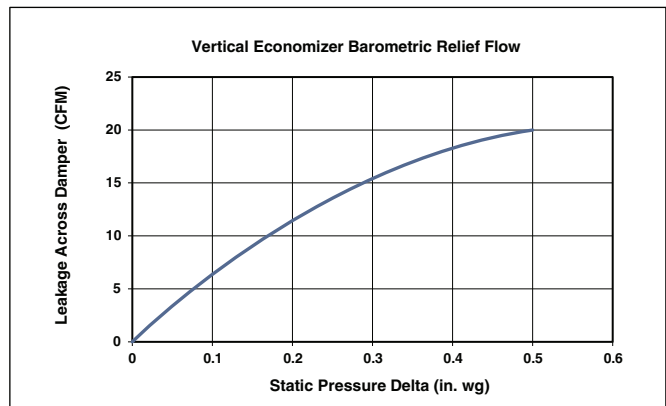

HUMIDI-MIZER® COIL PRESSURE DROPS

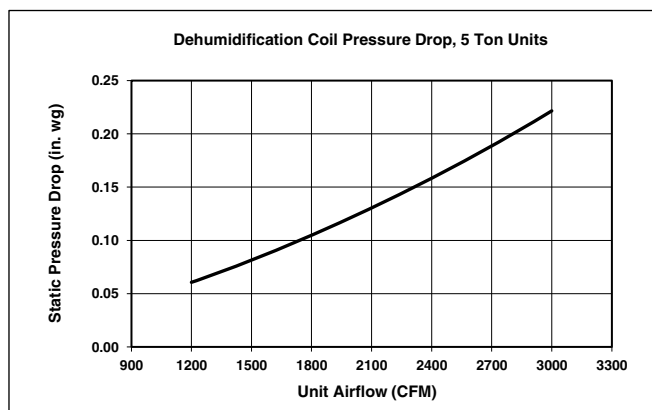
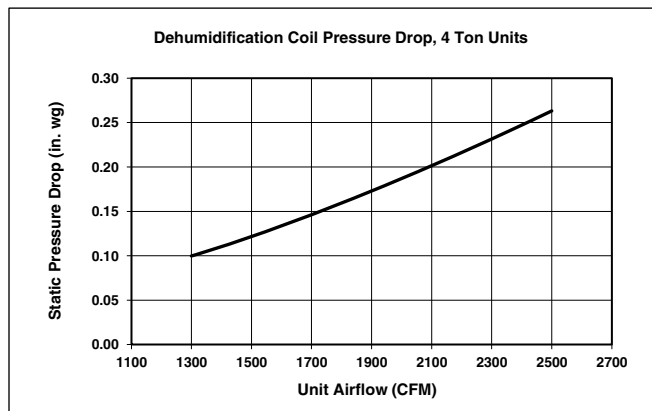
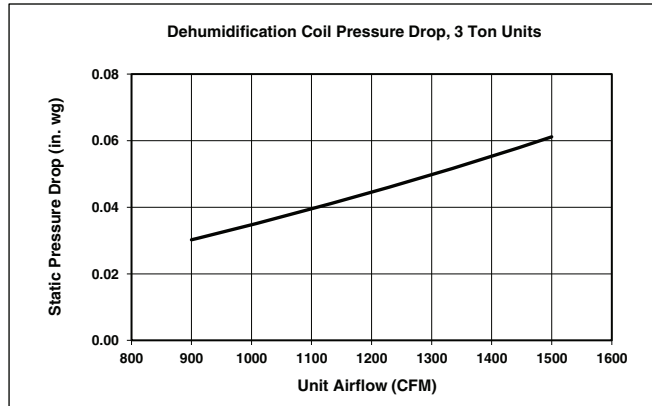

MERV-8 filters pressure drop

NOTE: For factory-installed MERV-8 filters, no additional pressure drop adjustments are necessary. The standard fan tables accommodate usage.

48GC04 SINGLE PHASE — 3 TON VERTICAL SUPPLY (RPM - BHP)**

CFM	AVAILABLE EXTERNAL STATIC PRESSURE (in. wg)									
	0.2		0.4		0.6		0.8		1.0	
	RPM	BHP	RPM	BHP	RPM	BHP	RPM	BHP	RPM	BHP
900	1129	0.10	1356	0.17	1544	0.26	1708	0.35	1857	0.45
975	1182	0.11	1402	0.19	1586	0.28	1748	0.37	1894	0.47
1050	1236	0.13	1449	0.21	1630	0.30	1789	0.40	1933	0.50
1125	1290	0.15	1498	0.23	1675	0.33	1831	0.43	1973	0.53
1200	1346	0.17	1547	0.26	1721	0.35	1874	0.46	2014	0.57
1275	1403	0.19	1598	0.28	1768	0.38	1919	0.49	2057	0.61
1350	1460	0.22	1651	0.31	1816	0.42	1965	0.53	2100	0.64
1425	1519	0.24	1703	0.34	1865	0.45	2012	0.57	2145	0.69
1500	1579	0.27	1757	0.38	1916	0.49	2059	0.61	2191	0.73

CFM	AVAILABLE EXTERNAL STATIC PRESSURE (in. wg)									
	1.2		1.4		1.6		1.8		2.0	
	RPM	BHP	RPM	BHP	RPM	BHP	RPM	BHP	RPM	BHP
900	1994	0.55	2121	0.66	2241	0.78	2354	0.91	2461	1.04
975	2029	0.58	2155	0.70	2274	0.82	2386	0.95	—	—
1050	2066	0.61	2190	0.73	2307	0.86	2419	0.99	—	—
1125	2104	0.65	2227	0.77	2343	0.90	2453	1.03	—	—
1200	2144	0.69	2265	0.81	2379	0.94	2488	1.07	—	—
1275	2184	0.73	2304	0.85	2417	0.98	—	—	—	—
1350	2226	0.77	2345	0.90	2456	1.03	—	—	—	—
1425	2269	0.81	2386	0.95	—	—	—	—	—	—
1500	2313	0.86	2429	1.00	—	—	—	—	—	—

- Standard Static 1129-1890 RPM, 0.44 Max BHP
- Medium Static 1129-2190 RPM, 0.71 Max BHP
- High Static 1129-2490 RPM, 1.07 Max BHP

NOTE: Fan tables include highest gas heat. Utilize static pressure gain tables for lower gas heat capacities.

48GC04 SINGLE PHASE - STANDARD STATIC — 3 TON VERTICAL SUPPLY (RPM - VDC)**

CFM	AVAILABLE EXTERNAL STATIC PRESSURE (in. wg)									
	0.2		0.4		0.6		0.8		1.0	
	RPM	Vdc	RPM	Vdc	RPM	Vdc	RPM	Vdc	RPM	Vdc
900	1129	6.0	1356	7.2	1544	8.2	1708	9.0	—	—
975	1182	6.3	1402	7.4	1586	8.4	1748	9.2	—	—
1050	1236	6.5	1449	7.7	1630	8.6	1789	9.5	—	—
1125	1290	6.8	1498	7.9	1675	8.9	1831	9.7	—	—
1200	1346	7.1	1547	8.2	1721	9.1	—	—	—	—
1275	1403	7.4	1598	8.5	1768	9.4	—	—	—	—
1350	1460	7.7	1651	8.7	1816	9.6	—	—	—	—
1425	1519	8.0	1703	9.0	—	—	—	—	—	—
1500	1579	8.4	1757	9.3	—	—	—	—	—	—

CFM	AVAILABLE EXTERNAL STATIC PRESSURE (in. wg)									
	1.2		1.4		1.6		1.8		2.0	
	RPM	Vdc	RPM	Vdc	RPM	Vdc	RPM	Vdc	RPM	Vdc
900	—	—	—	—	—	—	—	—	—	—
975	—	—	—	—	—	—	—	—	—	—
1050	—	—	—	—	—	—	—	—	—	—
1125	—	—	—	—	—	—	—	—	—	—
1200	—	—	—	—	—	—	—	—	—	—
1275	—	—	—	—	—	—	—	—	—	—
1350	—	—	—	—	—	—	—	—	—	—
1425	—	—	—	—	—	—	—	—	—	—
1500	—	—	—	—	—	—	—	—	—	—

- Standard Static 1129-1890 RPM

NOTE: Fan tables include highest gas heat. Utilize static pressure gain tables for lower gas heat capacities.

48GC**04 SINGLE PHASE - MEDIUM STATIC — 3 TON VERTICAL SUPPLY (RPM - VDC)

CFM	AVAILABLE EXTERNAL STATIC PRESSURE (in. wg)									
	0.2		0.4		0.6		0.8		1.0	
	RPM	Vdc	RPM	Vdc	RPM	Vdc	RPM	Vdc	RPM	Vdc
900	1129	5.2	1356	6.2	1544	7.1	1708	7.8	1857	8.5
975	1182	5.4	1402	6.4	1586	7.2	1748	8.0	1894	8.6
1050	1236	5.6	1449	6.6	1630	7.4	1789	8.2	1933	8.8
1125	1290	5.9	1498	6.8	1675	7.6	1831	8.4	1973	9.0
1200	1346	6.1	1547	7.1	1721	7.9	1874	8.6	2014	9.2
1275	1403	6.4	1598	7.3	1768	8.1	1919	8.8	2057	9.4
1350	1460	6.7	1651	7.5	1816	8.3	1965	9.0	2100	9.6
1425	1519	6.9	1703	7.8	1865	8.5	2012	9.2	2145	9.8
1500	1579	7.2	1757	8.0	1916	8.7	2059	9.4	—	—

CFM	AVAILABLE EXTERNAL STATIC PRESSURE (in. wg)									
	1.2		1.4		1.6		1.8		2.0	
	RPM	Vdc	RPM	Vdc	RPM	Vdc	RPM	Vdc	RPM	Vdc
900	1994	9.1	2121	9.7	—	—	—	—	—	—
975	2029	9.3	2155	9.8	—	—	—	—	—	—
1050	2066	9.4	—	—	—	—	—	—	—	—
1125	2104	9.6	—	—	—	—	—	—	—	—
1200	2144	9.8	—	—	—	—	—	—	—	—
1275	—	—	—	—	—	—	—	—	—	—
1350	—	—	—	—	—	—	—	—	—	—
1425	—	—	—	—	—	—	—	—	—	—
1500	—	—	—	—	—	—	—	—	—	—

Medium Static 1129-2190 RPM

NOTE: Fan tables include highest gas heat. Utilize static pressure gain tables for lower gas heat capacities.

48GC**04 SINGLE PHASE - HIGH STATIC — 3 TON VERTICAL SUPPLY (RPM - VDC)

CFM	AVAILABLE EXTERNAL STATIC PRESSURE (in. wg)									
	0.2		0.4		0.6		0.8		1.0	
	RPM	Vdc	RPM	Vdc	RPM	Vdc	RPM	Vdc	RPM	Vdc
900	1129	4.5	1356	5.4	1544	6.2	1708	6.9	1857	7.5
975	1182	4.7	1402	5.6	1586	6.4	1748	7.0	1894	7.6
1050	1236	5.0	1449	5.8	1630	6.5	1789	7.2	1933	7.8
1125	1290	5.2	1498	6.0	1675	6.7	1831	7.4	1973	7.9
1200	1346	5.4	1547	6.2	1721	6.9	1874	7.5	2014	8.1
1275	1403	5.6	1598	6.4	1768	7.1	1919	7.7	2057	8.3
1350	1460	5.9	1651	6.6	1816	7.3	1965	7.9	2100	8.4
1425	1519	6.1	1703	6.8	1865	7.5	2012	8.1	2145	8.6
1500	1579	6.3	1757	7.1	1916	7.7	2059	8.3	2191	8.8

CFM	AVAILABLE EXTERNAL STATIC PRESSURE (in. wg)									
	1.2		1.4		1.6		1.8		2.0	
	RPM	Vdc	RPM	Vdc	RPM	Vdc	RPM	Vdc	RPM	Vdc
900	1994	8.0	2121	8.5	2241	9.0	2354	9.5	2461	9.9
975	2029	8.1	2155	8.7	2274	9.1	2386	9.6	—	—
1050	2066	8.3	2190	8.8	2307	9.3	2419	9.7	—	—
1125	2104	8.4	2227	8.9	2343	9.4	2453	9.9	—	—
1200	2144	8.6	2265	9.1	2379	9.6	2488	10.0	—	—
1275	2184	8.8	2304	9.3	2417	9.7	—	—	—	—
1350	2226	8.9	2345	9.4	2456	9.9	—	—	—	—
1425	2269	9.1	2386	9.6	—	—	—	—	—	—
1500	2313	9.3	2429	9.8	—	—	—	—	—	—

High Static 1129-2490 RPM

NOTE: Fan tables include highest gas heat. Utilize static pressure gain tables for lower gas heat capacities.

48GC**04 THREE PHASE — 3 TON VERTICAL SUPPLY (RPM - BHP)

CFM	AVAILABLE EXTERNAL STATIC PRESSURE (in. wg)									
	0.2		0.4		0.6		0.8		1.0	
	RPM	BHP	RPM	BHP	RPM	BHP	RPM	BHP	RPM	BHP
900	1129	0.10	1356	0.17	1544	0.26	1708	0.35	1857	0.45
975	1182	0.11	1402	0.19	1586	0.28	1748	0.37	1894	0.47
1050	1236	0.13	1449	0.21	1630	0.30	1789	0.40	1933	0.50
1125	1290	0.15	1498	0.23	1675	0.33	1831	0.43	1973	0.53
1200	1346	0.17	1547	0.26	1721	0.35	1874	0.46	2014	0.57
1275	1403	0.19	1598	0.28	1768	0.38	1919	0.49	2057	0.61
1350	1460	0.22	1651	0.31	1816	0.42	1965	0.53	2100	0.64
1425	1519	0.24	1703	0.34	1865	0.45	2012	0.57	2145	0.69
1500	1579	0.27	1757	0.38	1916	0.49	2059	0.61	2191	0.73

CFM	AVAILABLE EXTERNAL STATIC PRESSURE (in. wg)									
	1.2		1.4		1.6		1.8		2.0	
	RPM	BHP	RPM	BHP	RPM	BHP	RPM	BHP	RPM	BHP
900	1994	0.55	2121	0.66	2241	0.78	2354	0.91	2461	1.04
975	2029	0.58	2155	0.70	2274	0.82	2386	0.95	—	—
1050	2066	0.61	2190	0.73	2307	0.86	2419	0.99	—	—
1125	2104	0.65	2227	0.77	2343	0.90	2453	1.03	—	—
1200	2144	0.69	2265	0.81	2379	0.94	2488	1.07	—	—
1275	2184	0.73	2304	0.85	2417	0.98	—	—	—	—
1350	2226	0.77	2345	0.90	2456	1.03	—	—	—	—
1425	2269	0.81	2386	0.95	—	—	—	—	—	—
1500	2313	0.86	2429	1.00	—	—	—	—	—	—

- Standard Static 1129-1890 RPM, 0.44 Max BHP
- Medium Static 1129-2190 RPM, 0.71 Max BHP
- High Static 1129-2490 RPM, 1.07 Max BHP

NOTE: Fan tables include highest gas heat. Utilize static pressure gain tables for lower gas heat capacities.

48GC**04 THREE PHASE - STANDARD STATIC — 3 TON VERTICAL SUPPLY (RPM - VDC)

CFM	AVAILABLE EXTERNAL STATIC PRESSURE (in. wg)									
	0.2		0.4		0.6		0.8		1.0	
	RPM	Vdc	RPM	Vdc	RPM	Vdc	RPM	Vdc	RPM	Vdc
900	1129	6.0	1356	7.2	1544	8.2	1708	9.0	—	—
975	1182	6.3	1402	7.4	1586	8.4	1748	9.2	—	—
1050	1236	6.5	1449	7.7	1630	8.6	1789	9.5	—	—
1125	1290	6.8	1498	7.9	1675	8.9	1831	9.7	—	—
1200	1346	7.1	1547	8.2	1721	9.1	—	—	—	—
1275	1403	7.4	1598	8.5	1768	9.4	—	—	—	—
1350	1460	7.7	1651	8.7	1816	9.6	—	—	—	—
1425	1519	8.0	1703	9.0	—	—	—	—	—	—
1500	1579	8.4	1757	9.3	—	—	—	—	—	—

CFM	AVAILABLE EXTERNAL STATIC PRESSURE (in. wg)									
	1.2		1.4		1.6		1.8		2.0	
	RPM	Vdc	RPM	Vdc	RPM	Vdc	RPM	Vdc	RPM	Vdc
900	—	—	—	—	—	—	—	—	—	—
975	—	—	—	—	—	—	—	—	—	—
1050	—	—	—	—	—	—	—	—	—	—
1125	—	—	—	—	—	—	—	—	—	—
1200	—	—	—	—	—	—	—	—	—	—
1275	—	—	—	—	—	—	—	—	—	—
1350	—	—	—	—	—	—	—	—	—	—
1425	—	—	—	—	—	—	—	—	—	—
1500	—	—	—	—	—	—	—	—	—	—

- Standard Static 1129-1890 RPM

NOTE: Fan tables include highest gas heat. Utilize static pressure gain tables for lower gas heat capacities.

48GC**04 THREE PHASE - MEDIUM STATIC — 3 TON VERTICAL SUPPLY (RPM - VDC)

CFM	AVAILABLE EXTERNAL STATIC PRESSURE (in. wg)									
	0.2		0.4		0.6		0.8		1.0	
	RPM	Vdc	RPM	Vdc	RPM	Vdc	RPM	Vdc	RPM	Vdc
900	1129	5.2	1356	6.2	1544	7.1	1708	7.8	1857	8.5
975	1182	5.4	1402	6.4	1586	7.2	1748	8.0	1894	8.6
1050	1236	5.6	1449	6.6	1630	7.4	1789	8.2	1933	8.8
1125	1290	5.9	1498	6.8	1675	7.6	1831	8.4	1973	9.0
1200	1346	6.1	1547	7.1	1721	7.9	1874	8.6	2014	9.2
1275	1403	6.4	1598	7.3	1768	8.1	1919	8.8	2057	9.4
1350	1460	6.7	1651	7.5	1816	8.3	1965	9.0	2100	9.6
1425	1519	6.9	1703	7.8	1865	8.5	2012	9.2	2145	9.8
1500	1579	7.2	1757	8.0	1916	8.7	2059	9.4	—	—

CFM	AVAILABLE EXTERNAL STATIC PRESSURE (in. wg)									
	1.2		1.4		1.6		1.8		2.0	
	RPM	Vdc	RPM	Vdc	RPM	Vdc	RPM	Vdc	RPM	Vdc
900	1994	9.1	2121	9.7	—	—	—	—	—	—
975	2029	9.3	2155	9.8	—	—	—	—	—	—
1050	2066	9.4	—	—	—	—	—	—	—	—
1125	2104	9.6	—	—	—	—	—	—	—	—
1200	2144	9.8	—	—	—	—	—	—	—	—
1275	—	—	—	—	—	—	—	—	—	—
1350	—	—	—	—	—	—	—	—	—	—
1425	—	—	—	—	—	—	—	—	—	—
1500	—	—	—	—	—	—	—	—	—	—

Medium Static 1129-2190 RPM

NOTE: Fan tables include highest gas heat. Utilize static pressure gain tables for lower gas heat capacities.

48GC**04 THREE PHASE - HIGH STATIC — 3 TON VERTICAL SUPPLY (RPM - VDC)

CFM	AVAILABLE EXTERNAL STATIC PRESSURE (in. wg)									
	0.2		0.4		0.6		0.8		1.0	
	RPM	Vdc	RPM	Vdc	RPM	Vdc	RPM	Vdc	RPM	Vdc
900	1129	4.5	1356	5.4	1544	6.2	1708	6.9	1857	7.5
975	1182	4.7	1402	5.6	1586	6.4	1748	7.0	1894	7.6
1050	1236	5.0	1449	5.8	1630	6.5	1789	7.2	1933	7.8
1125	1290	5.2	1498	6.0	1675	6.7	1831	7.4	1973	7.9
1200	1346	5.4	1547	6.2	1721	6.9	1874	7.5	2014	8.1
1275	1403	5.6	1598	6.4	1768	7.1	1919	7.7	2057	8.3
1350	1460	5.9	1651	6.6	1816	7.3	1965	7.9	2100	8.4
1425	1519	6.1	1703	6.8	1865	7.5	2012	8.1	2145	8.6
1500	1579	6.3	1757	7.1	1916	7.7	2059	8.3	2191	8.8

CFM	AVAILABLE EXTERNAL STATIC PRESSURE (in. wg)									
	1.2		1.4		1.6		1.8		2.0	
	RPM	Vdc	RPM	Vdc	RPM	Vdc	RPM	Vdc	RPM	Vdc
900	1994	8.0	2121	8.5	2241	9.0	2354	9.5	2461	9.9
975	2029	8.1	2155	8.7	2274	9.1	2386	9.6	—	—
1050	2066	8.3	2190	8.8	2307	9.3	2419	9.7	—	—
1125	2104	8.4	2227	8.9	2343	9.4	2453	9.9	—	—
1200	2144	8.6	2265	9.1	2379	9.6	2488	10.0	—	—
1275	2184	8.8	2304	9.3	2417	9.7	—	—	—	—
1350	2226	8.9	2345	9.4	2456	9.9	—	—	—	—
1425	2269	9.1	2386	9.6	—	—	—	—	—	—
1500	2313	9.3	2429	9.8	—	—	—	—	—	—

High Static 1129-2490 RPM

NOTE: Fan tables include highest gas heat. Utilize static pressure gain tables for lower gas heat capacities.

48GC**05 SINGLE PHASE — 4 TON VERTICAL SUPPLY (RPM - BHP)

CFM	AVAILABLE EXTERNAL STATIC PRESSURE (in. wg)									
	0.2		0.4		0.6		0.8		1.0	
	RPM	BHP	RPM	BHP	RPM	BHP	RPM	BHP	RPM	BHP
1200	1262	0.21	1453	0.33	1614	0.45	1757	0.58	1888	0.72
1300	1333	0.25	1517	0.37	1674	0.50	1813	0.63	1942	0.78
1400	1405	0.29	1583	0.42	1735	0.55	1872	0.70	1997	0.84
1500	1478	0.34	1650	0.48	1799	0.62	1932	0.76	2055	0.92
1600	1552	0.40	1718	0.54	1863	0.68	1994	0.84	2114	1.00
1700	1627	0.46	1787	0.60	1929	0.76	2057	0.92	2174	1.09
1800	1704	0.52	1857	0.68	1995	0.84	2121	1.01	2236	1.18
1900	1781	0.60	1929	0.76	2063	0.93	2186	1.10	2299	1.28
2000	1859	0.68	2001	0.85	2132	1.02	2252	1.21	2363	1.39

CFM	AVAILABLE EXTERNAL STATIC PRESSURE (in. wg)									
	1.2		1.4		1.6		1.8		2.0	
	RPM	BHP	RPM	BHP	RPM	BHP	RPM	BHP	RPM	BHP
1200	2011	0.87	2126	1.02	2236	1.19	2341	1.37	2442	1.56
1300	2061	0.93	2174	1.09	2281	1.26	2383	1.44	—	—
1400	2114	1.00	2224	1.17	2329	1.34	2429	1.52	—	—
1500	2169	1.08	2277	1.25	2379	1.43	—	—	—	—
1600	2226	1.17	2331	1.34	2432	1.52	—	—	—	—
1700	2284	1.26	2388	1.44	—	—	—	—	—	—
1800	2344	1.36	2446	1.55	—	—	—	—	—	—
1900	2405	1.47	—	—	—	—	—	—	—	—
2000	—	—	—	—	—	—	—	—	—	—

- Standard Static 1262-1900 RPM, 0.72 Max BHP
- Medium Static 1262-2170 RPM, 1.06 Max BHP
- High Static 1262-2460 RPM, 1.53 Max BHP

NOTE: Fan tables include highest gas heat. Utilize static pressure gain tables for lower gas heat capacities.

48GC**05 SINGLE PHASE - STANDARD STATIC — 4 TON VERTICAL SUPPLY (RPM - VDC)

CFM	AVAILABLE EXTERNAL STATIC PRESSURE (in. wg)									
	0.2		0.4		0.6		0.8		1.0	
	RPM	Vdc	RPM	Vdc	RPM	Vdc	RPM	Vdc	RPM	Vdc
1200	1262	6.6	1453	7.6	1614	8.5	1757	9.2	1888	9.9
1300	1333	7.0	1517	8.0	1674	8.8	1813	9.5	—	—
1400	1405	7.4	1583	8.3	1735	9.1	1872	9.9	—	—
1500	1478	7.8	1650	8.7	1799	9.5	—	—	—	—
1600	1552	8.2	1718	9.0	1863	9.8	—	—	—	—
1700	1627	8.6	1787	9.4	—	—	—	—	—	—
1800	1704	9.0	1857	9.8	—	—	—	—	—	—
1900	1781	9.4	—	—	—	—	—	—	—	—
2000	1859	9.8	—	—	—	—	—	—	—	—

CFM	AVAILABLE EXTERNAL STATIC PRESSURE (in. wg)									
	1.2		1.4		1.6		1.8		2.0	
	RPM	Vdc	RPM	Vdc	RPM	Vdc	RPM	Vdc	RPM	Vdc
1200	—	—	—	—	—	—	—	—	—	—
1300	—	—	—	—	—	—	—	—	—	—
1400	—	—	—	—	—	—	—	—	—	—
1500	—	—	—	—	—	—	—	—	—	—
1600	—	—	—	—	—	—	—	—	—	—
1700	—	—	—	—	—	—	—	—	—	—
1800	—	—	—	—	—	—	—	—	—	—
1900	—	—	—	—	—	—	—	—	—	—
2000	—	—	—	—	—	—	—	—	—	—

- Standard Static 1262-1900 RPM

NOTE: Fan tables include highest gas heat. Utilize static pressure gain tables for lower gas heat capacities.

48GC**05 SINGLE PHASE - MEDIUM STATIC — 4 TON VERTICAL SUPPLY (RPM - VDC)

CFM	AVAILABLE EXTERNAL STATIC PRESSURE (in. wg)									
	0.2		0.4		0.6		0.8		1.0	
	RPM	Vdc	RPM	Vdc	RPM	Vdc	RPM	Vdc	RPM	Vdc
1200	1262	5.8	1453	6.7	1614	7.4	1757	8.1	1888	8.7
1300	1333	6.1	1517	7.0	1674	7.7	1813	8.4	1942	8.9
1400	1405	6.5	1583	7.3	1735	8.0	1872	8.6	1997	9.2
1500	1478	6.8	1650	7.6	1799	8.3	1932	8.9	2055	9.5
1600	1552	7.2	1718	7.9	1863	8.6	1994	9.2	2114	9.7
1700	1627	7.5	1787	8.2	1929	8.9	2057	9.5	—	—
1800	1704	7.9	1857	8.6	1995	9.2	2121	9.8	—	—
1900	1781	8.2	1929	8.9	2063	9.5	—	—	—	—
2000	1859	8.6	2001	9.2	2132	9.8	—	—	—	—

CFM	AVAILABLE EXTERNAL STATIC PRESSURE (in. wg)									
	1.2		1.4		1.6		1.8		2.0	
	RPM	Vdc	RPM	Vdc	RPM	Vdc	RPM	Vdc	RPM	Vdc
1200	2011	9.3	2126	9.8	—	—	—	—	—	—
1300	2061	9.5	—	—	—	—	—	—	—	—
1400	2114	9.7	—	—	—	—	—	—	—	—
1500	—	—	—	—	—	—	—	—	—	—
1600	—	—	—	—	—	—	—	—	—	—
1700	—	—	—	—	—	—	—	—	—	—
1800	—	—	—	—	—	—	—	—	—	—
1900	—	—	—	—	—	—	—	—	—	—
2000	—	—	—	—	—	—	—	—	—	—

Medium Static 1262-2170 RPM

NOTE: Fan tables include highest gas heat. Utilize static pressure gain tables for lower gas heat capacities.

48GC**05 SINGLE PHASE - HIGH STATIC — 4 TON VERTICAL SUPPLY (RPM - VDC)

CFM	AVAILABLE EXTERNAL STATIC PRESSURE (in. wg)									
	0.2		0.4		0.6		0.8		1.0	
	RPM	Vdc	RPM	Vdc	RPM	Vdc	RPM	Vdc	RPM	Vdc
1200	1262	5.1	1453	5.9	1614	6.6	1757	7.1	1888	7.7
1300	1333	5.4	1517	6.2	1674	6.8	1813	7.4	1942	7.9
1400	1405	5.7	1583	6.4	1735	7.1	1872	7.6	1997	8.1
1500	1478	6.0	1650	6.7	1799	7.3	1932	7.9	2055	8.4
1600	1552	6.3	1718	7.0	1863	7.6	1994	8.1	2114	8.6
1700	1627	6.6	1787	7.3	1929	7.8	2057	8.4	2174	8.8
1800	1704	6.9	1857	7.5	1995	8.1	2121	8.6	2236	9.1
1900	1781	7.2	1929	7.8	2063	8.4	2186	8.9	2299	9.3
2000	1859	7.6	2001	8.1	2132	8.7	2252	9.2	2363	9.6

CFM	AVAILABLE EXTERNAL STATIC PRESSURE (in. wg)									
	1.2		1.4		1.6		1.8		2.0	
	RPM	Vdc	RPM	Vdc	RPM	Vdc	RPM	Vdc	RPM	Vdc
1200	2011	8.2	2126	8.6	2236	9.1	2341	9.5	2442	9.9
1300	2061	8.4	2174	8.8	2281	9.3	2383	9.7	—	—
1400	2114	8.6	2224	9.0	2329	9.5	2429	9.9	—	—
1500	2169	8.8	2277	9.3	2379	9.7	—	—	—	—
1600	2226	9.0	2331	9.5	2432	9.9	—	—	—	—
1700	2284	9.3	2388	9.7	—	—	—	—	—	—
1800	2344	9.5	2446	9.9	—	—	—	—	—	—
1900	2405	9.8	—	—	—	—	—	—	—	—
2000	—	—	—	—	—	—	—	—	—	—

High Static 1262-2460 RPM

NOTE: Fan tables include highest gas heat. Utilize static pressure gain tables for lower gas heat capacities.

48GC**05 THREE PHASE — 4 TON VERTICAL SUPPLY (RPM - BHP)

CFM	AVAILABLE EXTERNAL STATIC PRESSURE (in. wg)									
	0.2		0.4		0.6		0.8		1.0	
	RPM	BHP	RPM	BHP	RPM	BHP	RPM	BHP	RPM	BHP
1200	1262	0.21	1452	0.33	1614	0.45	1757	0.58	1888	0.72
1300	1333	0.25	1516	0.37	1674	0.50	1813	0.63	1942	0.78
1400	1405	0.29	1583	0.42	1735	0.55	1872	0.70	1997	0.84
1500	1478	0.34	1650	0.48	1798	0.62	1932	0.76	2054	0.92
1600	1552	0.40	1718	0.54	1863	0.68	1993	0.84	2114	1.00
1700	1627	0.46	1787	0.60	1928	0.76	2057	0.92	2174	1.09
1800	1704	0.52	1857	0.68	1995	0.84	2121	1.01	2236	1.18
1900	1781	0.60	1929	0.76	2063	0.93	2185	1.10	2299	1.28
2000	1859	0.68	2001	0.85	2132	1.02	2252	1.21	2363	1.39

CFM	AVAILABLE EXTERNAL STATIC PRESSURE (in. wg)									
	1.2		1.4		1.6		1.8		2.0	
	RPM	BHP	RPM	BHP	RPM	BHP	RPM	BHP	RPM	BHP
1200	2011	0.87	2126	1.02	2236	1.19	2341	1.37	2442	1.55
1300	2061	0.93	2174	1.09	2281	1.26	2384	1.44	2482	1.62
1400	2114	1.00	2224	1.17	2329	1.34	2429	1.52	2526	1.71
1500	2169	1.08	2277	1.25	2379	1.43	2477	1.61	2572	1.80
1600	2226	1.17	2331	1.34	2432	1.52	2528	1.71	2621	1.91
1700	2284	1.26	2388	1.44	2486	1.63	2581	1.82	—	—
1800	2344	1.36	2446	1.55	2543	1.74	2636	1.94	—	—
1900	2405	1.47	2505	1.66	2600	1.86	—	—	—	—
2000	2467	1.59	2565	1.78	2659	1.99	—	—	—	—

- Standard Static 1262-1900 RPM, 0.72 Max BHP
- Medium Static 1262-2170 RPM, 1.06 Max BHP
- High Static 1262-2660 RPM, 1.96 Max BHP

NOTE: Fan tables include highest gas heat. Utilize static pressure gain tables for lower gas heat capacities.

48GC**05 THREE PHASE - STANDARD STATIC — 4 TON VERTICAL SUPPLY (RPM - VDC)

CFM	AVAILABLE EXTERNAL STATIC PRESSURE (in. wg)									
	0.2		0.4		0.6		0.8		1.0	
	RPM	Vdc	RPM	Vdc	RPM	Vdc	RPM	Vdc	RPM	Vdc
1200	1262	6.6	1453	7.6	1614	8.5	1757	9.2	1888	9.9
1300	1333	7.0	1517	8.0	1674	8.8	1813	9.5	—	—
1400	1405	7.4	1583	8.3	1735	9.1	1872	9.9	—	—
1500	1478	7.8	1650	8.7	1799	9.5	—	—	—	—
1600	1552	8.2	1718	9.0	1863	9.8	—	—	—	—
1700	1627	8.6	1787	9.4	—	—	—	—	—	—
1800	1704	9.0	1857	9.8	—	—	—	—	—	—
1900	1781	9.4	—	—	—	—	—	—	—	—
2000	1859	9.8	—	—	—	—	—	—	—	—

CFM	AVAILABLE EXTERNAL STATIC PRESSURE (in. wg)									
	1.2		1.4		1.6		1.8		2.0	
	RPM	Vdc	RPM	Vdc	RPM	Vdc	RPM	Vdc	RPM	Vdc
1200	—	—	—	—	—	—	—	—	—	—
1300	—	—	—	—	—	—	—	—	—	—
1400	—	—	—	—	—	—	—	—	—	—
1500	—	—	—	—	—	—	—	—	—	—
1600	—	—	—	—	—	—	—	—	—	—
1700	—	—	—	—	—	—	—	—	—	—
1800	—	—	—	—	—	—	—	—	—	—
1900	—	—	—	—	—	—	—	—	—	—
2000	—	—	—	—	—	—	—	—	—	—

- Standard Static 1262-1900 RPM

NOTE: Fan tables include highest gas heat. Utilize static pressure gain tables for lower gas heat capacities.

48GC**05 THREE PHASE - MEDIUM STATIC — 4 TON VERTICAL SUPPLY (RPM - VDC)

CFM	AVAILABLE EXTERNAL STATIC PRESSURE (in. wg)									
	0.2		0.4		0.6		0.8		1.0	
	RPM	Vdc	RPM	Vdc	RPM	Vdc	RPM	Vdc	RPM	Vdc
1200	1262	5.8	1453	6.7	1614	7.4	1757	8.1	1888	8.7
1300	1333	6.1	1517	7.0	1674	7.7	1813	8.4	1942	8.9
1400	1405	6.5	1583	7.3	1735	8.0	1872	8.6	1997	9.2
1500	1478	6.8	1650	7.6	1799	8.3	1932	8.9	2055	9.5
1600	1552	7.2	1718	7.9	1863	8.6	1994	9.2	2114	9.7
1700	1627	7.5	1787	8.2	1929	8.9	2057	9.5	—	—
1800	1704	7.9	1857	8.6	1995	9.2	2121	9.8	—	—
1900	1781	8.2	1929	8.9	2063	9.5	—	—	—	—
2000	1859	8.6	2001	9.2	2132	9.8	—	—	—	—

CFM	AVAILABLE EXTERNAL STATIC PRESSURE (in. wg)									
	1.2		1.4		1.6		1.8		2.0	
	RPM	Vdc	RPM	Vdc	RPM	Vdc	RPM	Vdc	RPM	Vdc
1200	2011	9.3	2126	9.8	—	—	—	—	—	—
1300	2061	9.5	—	—	—	—	—	—	—	—
1400	2114	9.7	—	—	—	—	—	—	—	—
1500	—	—	—	—	—	—	—	—	—	—
1600	—	—	—	—	—	—	—	—	—	—
1700	—	—	—	—	—	—	—	—	—	—
1800	—	—	—	—	—	—	—	—	—	—
1900	—	—	—	—	—	—	—	—	—	—
2000	—	—	—	—	—	—	—	—	—	—

Medium Static 1262-2170 RPM

NOTE: Fan tables include highest gas heat. Utilize static pressure gain tables for lower gas heat capacities.

48GC**05 THREE PHASE - HIGH STATIC — 4 TON VERTICAL SUPPLY (RPM - VDC)

CFM	AVAILABLE EXTERNAL STATIC PRESSURE (in. wg)									
	0.2		0.4		0.6		0.8		1.0	
	RPM	Vdc	RPM	Vdc	RPM	Vdc	RPM	Vdc	RPM	Vdc
1200	1262	4.7	1452	5.5	1614	6.1	1757	6.6	1888	7.1
1300	1333	5.0	1516	5.7	1674	6.3	1813	6.8	1942	7.3
1400	1405	5.3	1583	6.0	1735	6.5	1872	7.0	1997	7.5
1500	1478	5.6	1650	6.2	1798	6.8	1932	7.3	2054	7.7
1600	1552	5.8	1718	6.5	1863	7.0	1993	7.5	2114	7.9
1700	1627	6.1	1787	6.7	1928	7.2	2057	7.7	2174	8.2
1800	1704	6.4	1857	7.0	1995	7.5	2121	8.0	2236	8.4
1900	1781	6.7	1929	7.3	2063	7.8	2185	8.2	2299	8.6
2000	1859	7.0	2001	7.5	2132	8.0	2252	8.5	2363	8.9

CFM	AVAILABLE EXTERNAL STATIC PRESSURE (in. wg)									
	1.2		1.4		1.6		1.8		2.0	
	RPM	Vdc	RPM	Vdc	RPM	Vdc	RPM	Vdc	RPM	Vdc
1200	2011	7.6	2126	8.0	2236	8.4	2341	8.8	2442	9.2
1300	2061	7.7	2174	8.2	2281	8.6	2384	9.0	2482	9.3
1400	2114	7.9	2224	8.4	2329	8.8	2429	9.1	2526	9.5
1500	2169	8.2	2277	8.6	2379	8.9	2477	9.3	2572	9.7
1600	2226	8.4	2331	8.8	2432	9.1	2528	9.5	2621	9.9
1700	2284	8.6	2388	9.0	2486	9.3	2581	9.7	—	—
1800	2344	8.8	2446	9.2	2543	9.6	2623	9.9	—	—
1900	2405	9.0	2505	9.4	2600	9.8	—	—	—	—
2000	2467	9.3	2565	9.6	2659	10.0	—	—	—	—

High Static 1262-2660 RPM

NOTE: Fan tables include highest gas heat. Utilize static pressure gain tables for lower gas heat capacities.

48GC**06 SINGLE PHASE — 5 TON VERTICAL SUPPLY (RPM - BHP)

CFM	AVAILABLE EXTERNAL STATIC PRESSURE (in. wg)									
	0.2		0.4		0.6		0.8		1.0	
	RPM	BHP	RPM	BHP	RPM	BHP	RPM	BHP	RPM	BHP
1500	1387	0.28	1561	0.40	1711	0.53	1845	0.66	1966	0.80
1625	1473	0.34	1638	0.46	1784	0.60	1914	0.74	2034	0.89
1750	1560	0.40	1717	0.53	1859	0.68	1986	0.83	2103	0.98
1875	1650	0.47	1798	0.61	1935	0.77	2059	0.92	2174	1.08
2000	1741	0.56	1881	0.70	2012	0.86	2134	1.03	2246	1.20
2125	1832	0.65	1965	0.80	2091	0.97	2209	1.14	2320	1.32
2250	1925	0.75	2050	0.91	2172	1.08	2286	1.26	—	—
2375	2018	0.87	2137	1.03	2254	1.21	2365	1.40	—	—
2500	2113	1.00	2225	1.16	2337	1.35	—	—	—	—

CFM	AVAILABLE EXTERNAL STATIC PRESSURE (in. wg)									
	1.2		1.4		1.6		1.8		2.0	
	RPM	BHP	RPM	BHP	RPM	BHP	RPM	BHP	RPM	BHP
1500	2079	0.95	2185	1.10	2285	1.26	2381	1.43	—	—
1625	2144	1.04	2248	1.20	2346	1.36	—	—	—	—
1750	2211	1.14	2313	1.31	—	—	—	—	—	—
1875	2281	1.25	2380	1.42	—	—	—	—	—	—
2000	2351	1.37	—	—	—	—	—	—	—	—
2125	—	—	—	—	—	—	—	—	—	—
2250	—	—	—	—	—	—	—	—	—	—
2375	—	—	—	—	—	—	—	—	—	—
2500	—	—	—	—	—	—	—	—	—	—

Standard Static 1387-2150 RPM, 1.06 Max BHP

Medium Static 1387-2390 RPM, 1.44 Max BHP

NOTE: Fan tables include highest gas heat. Utilize static pressure gain tables for lower gas heat capacities.

48GC**06 SINGLE PHASE - STANDARD STATIC — 5 TON VERTICAL SUPPLY (RPM - VDC)

CFM	AVAILABLE EXTERNAL STATIC PRESSURE (in. wg)									
	0.2		0.4		0.6		0.8		1.0	
	RPM	Vdc	RPM	Vdc	RPM	Vdc	RPM	Vdc	RPM	Vdc
1500	1387	6.5	1561	7.3	1711	8.0	1845	8.6	1966	9.1
1625	1473	6.9	1638	7.6	1784	8.3	1914	8.9	2034	9.5
1750	1560	7.3	1717	8.0	1859	8.6	1986	9.2	2103	9.8
1875	1650	7.7	1798	8.4	1935	9.0	2059	9.6	—	—
2000	1741	8.1	1881	8.7	2012	9.4	2134	9.9	—	—
2125	1832	8.5	1965	9.1	2091	9.7	—	—	—	—
2250	1925	9.0	2050	9.5	—	—	—	—	—	—
2375	2018	9.4	2137	9.9	—	—	—	—	—	—
2500	2113	9.8	—	—	—	—	—	—	—	—

CFM	AVAILABLE EXTERNAL STATIC PRESSURE (in. wg)									
	1.2		1.4		1.6		1.8		2.0	
	RPM	Vdc	RPM	Vdc	RPM	Vdc	RPM	Vdc	RPM	Vdc
1500	2079	9.7	—	—	—	—	—	—	—	—
1625	2144	10.0	—	—	—	—	—	—	—	—
1750	—	—	—	—	—	—	—	—	—	—
1875	—	—	—	—	—	—	—	—	—	—
2000	—	—	—	—	—	—	—	—	—	—
2125	—	—	—	—	—	—	—	—	—	—
2250	—	—	—	—	—	—	—	—	—	—
2375	—	—	—	—	—	—	—	—	—	—
2500	—	—	—	—	—	—	—	—	—	—

Standard Static 1387-2150 RPM

NOTE: Fan tables include highest gas heat. Utilize static pressure gain tables for lower gas heat capacities.

48GC**06 SINGLE PHASE - MEDIUM STATIC — 5 TON VERTICAL SUPPLY (RPM - VDC)

CFM	AVAILABLE EXTERNAL STATIC PRESSURE (in. wg)									
	0.2		0.4		0.6		0.8		1.0	
	RPM	Vdc	RPM	Vdc	RPM	Vdc	RPM	Vdc	RPM	Vdc
1500	1387	5.8	1561	6.5	1711	7.2	1845	7.7	1966	8.2
1625	1473	6.2	1638	6.9	1784	7.5	1914	8.0	2034	8.5
1750	1560	6.5	1717	7.2	1859	7.8	1986	8.3	2103	8.8
1875	1650	6.9	1798	7.5	1935	8.1	2059	8.6	2174	9.1
2000	1741	7.3	1881	7.9	2012	8.4	2134	8.9	2246	9.4
2125	1832	7.7	1965	8.2	2091	8.7	2209	9.2	2320	9.7
2250	1925	8.1	2050	8.6	2172	9.1	2286	9.6	—	—
2375	2018	8.4	2137	8.9	2254	9.4	2365	9.9	—	—
2500	2113	8.8	2225	9.3	2337	9.8	—	—	—	—

CFM	AVAILABLE EXTERNAL STATIC PRESSURE (in. wg)									
	1.2		1.4		1.6		1.8		2.0	
	RPM	Vdc	RPM	Vdc	RPM	Vdc	RPM	Vdc	RPM	Vdc
1500	2079	8.7	2185	9.1	2285	9.6	2381	10.0	—	—
1625	2144	9.0	2248	9.4	2346	9.8	—	—	—	—
1750	2211	9.3	2313	9.7	—	—	—	—	—	—
1875	2281	9.5	2380	10.0	—	—	—	—	—	—
2000	2351	9.8	—	—	—	—	—	—	—	—
2125	—	—	—	—	—	—	—	—	—	—
2250	—	—	—	—	—	—	—	—	—	—
2375	—	—	—	—	—	—	—	—	—	—
2500	—	—	—	—	—	—	—	—	—	—

Medium Static 1387-2390 RPM

NOTE: Fan tables include highest gas heat. Utilize static pressure gain tables for lower gas heat capacities.

48GC**06 THREE PHASE — 5 TON VERTICAL SUPPLY (RPM - BHP)

CFM	AVAILABLE EXTERNAL STATIC PRESSURE (in. wg)									
	0.2		0.4		0.6		0.8		1.0	
	RPM	BHP	RPM	BHP	RPM	BHP	RPM	BHP	RPM	BHP
1500	1387	0.28	1560	0.40	1711	0.53	1845	0.66	1966	0.80
1625	1473	0.34	1638	0.46	1784	0.60	1915	0.74	2034	0.89
1750	1561	0.40	1717	0.53	1858	0.68	1986	0.83	2103	0.98
1875	1650	0.47	1798	0.61	1934	0.76	2059	0.92	2174	1.08
2000	1741	0.56	1881	0.70	2012	0.86	2133	1.02	2246	1.20
2125	1832	0.65	1965	0.80	2091	0.97	2209	1.14	2319	1.32
2250	1925	0.75	2050	0.91	2172	1.08	2286	1.26	2394	1.45
2375	2018	0.87	2137	1.03	2254	1.21	2364	1.40	2469	1.59
2500	2113	1.00	2225	1.16	2337	1.35	2444	1.54	2547	1.75

CFM	AVAILABLE EXTERNAL STATIC PRESSURE (in. wg)									
	1.2		1.4		1.6		1.8		2.0	
	RPM	BHP	RPM	BHP	RPM	BHP	RPM	BHP	RPM	BHP
1500	2079	0.95	2185	1.10	2285	1.26	2381	1.43	2473	1.60
1625	2144	1.04	2248	1.20	2346	1.36	2440	1.53	2530	1.71
1750	2212	1.14	2313	1.31	2410	1.48	2502	1.65	2590	1.83
1875	2281	1.25	2381	1.43	2475	1.60	2566	1.78	2653	1.97
2000	2351	1.37	2449	1.55	2543	1.74	2632	1.93	2717	2.12
2125	2422	1.50	2519	1.69	2611	1.88	2699	2.08	2783	2.28
2250	2495	1.64	2590	1.84	2681	2.04	2767	2.24	—	—
2375	2569	1.79	2663	2.00	2752	2.20	—	—	—	—
2500	2643	1.95	2736	2.17	2824	2.38	—	—	—	—

- Standard Static 1387-2150 RPM, 1.06 Max BHP
- Medium Static 1387-2390 RPM, 1.44 Max BHP
- High Static 1387-2836 RPM, 2.43 Max BHP

NOTE: Fan tables include highest gas heat. Utilize static pressure gain tables for lower gas heat capacities.

48GC**06 THREE PHASE — STANDARD STATIC — 5 TON VERTICAL SUPPLY (RPM - VDC)

CFM	AVAILABLE EXTERNAL STATIC PRESSURE (in. wg)									
	0.2		0.4		0.6		0.8		1.0	
	RPM	Vdc	RPM	Vdc	RPM	Vdc	RPM	Vdc	RPM	Vdc
1500	1387	6.5	1560	7.3	1711	8.0	1845	8.6	1966	9.1
1625	1473	6.9	1638	7.6	1784	8.3	1915	8.9	2034	9.5
1750	1561	7.3	1717	8.0	1858	8.6	1986	9.2	2103	9.8
1875	1650	7.7	1798	8.4	1934	9.0	2059	9.6	—	—
2000	1741	8.1	1881	8.7	2012	9.4	2133	9.9	—	—
2125	1832	8.5	1965	9.1	2091	9.7	—	—	—	—
2250	1925	9.0	2050	9.5	—	—	—	—	—	—
2375	2018	9.4	2137	9.9	—	—	—	—	—	—
2500	2113	9.8	—	—	—	—	—	—	—	—

CFM	AVAILABLE EXTERNAL STATIC PRESSURE (in. wg)									
	1.2		1.4		1.6		1.8		2.0	
	RPM	Vdc	RPM	Vdc	RPM	Vdc	RPM	Vdc	RPM	Vdc
1500	2079	9.7	—	—	—	—	—	—	—	—
1625	2144	10.0	—	—	—	—	—	—	—	—
1750	—	—	—	—	—	—	—	—	—	—
1875	—	—	—	—	—	—	—	—	—	—
2000	—	—	—	—	—	—	—	—	—	—
2125	—	—	—	—	—	—	—	—	—	—
2250	—	—	—	—	—	—	—	—	—	—
2375	—	—	—	—	—	—	—	—	—	—
2500	—	—	—	—	—	—	—	—	—	—

- Standard Static 1387-2150 RPM

NOTE: Fan tables include highest gas heat. Utilize static pressure gain tables for lower gas heat capacities.

48GC**06 THREE PHASE - MEDIUM STATIC — 5 TON VERTICAL SUPPLY (RPM - VDC)

CFM	AVAILABLE EXTERNAL STATIC PRESSURE (in. wg)									
	0.2		0.4		0.6		0.8		1.0	
	RPM	Vdc	RPM	Vdc	RPM	Vdc	RPM	Vdc	RPM	Vdc
1500	1387	5.8	1560	6.5	1711	7.2	1845	7.7	1966	8.2
1625	1473	6.2	1638	6.9	1784	7.5	1915	8.0	2034	8.5
1750	1561	6.5	1717	7.2	1858	7.8	1986	8.3	2103	8.8
1875	1650	6.9	1798	7.5	1934	8.1	2059	8.6	2174	9.1
2000	1741	7.3	1881	7.9	2012	8.4	2133	8.9	2246	9.4
2125	1832	7.7	1965	8.2	2091	8.7	2209	9.2	2319	9.7
2250	1925	8.1	2050	8.6	2172	9.1	2286	9.6	—	—
2375	2018	8.4	2137	8.9	2254	9.4	2364	9.9	—	—
2500	2113	8.8	2225	9.3	2337	9.8	—	—	—	—

CFM	AVAILABLE EXTERNAL STATIC PRESSURE (in. wg)									
	1.2		1.4		1.6		1.8		2.0	
	RPM	Vdc	RPM	Vdc	RPM	Vdc	RPM	Vdc	RPM	Vdc
1500	2079	8.7	2185	9.1	2285	9.6	2381	10.0	—	—
1625	2144	9.0	2248	9.4	2346	9.8	—	—	—	—
1750	2212	9.3	2313	9.7	—	—	—	—	—	—
1875	2281	9.5	2381	10.0	—	—	—	—	—	—
2000	2351	9.8	—	—	—	—	—	—	—	—
2125	—	—	—	—	—	—	—	—	—	—
2250	—	—	—	—	—	—	—	—	—	—
2375	—	—	—	—	—	—	—	—	—	—
2500	—	—	—	—	—	—	—	—	—	—

Medium Static 1387-2390 RPM

NOTE: Fan tables include highest gas heat. Utilize static pressure gain tables for lower gas heat capacities.

48GC**06 THREE PHASE - HIGH STATIC — 5 TON VERTICAL SUPPLY (RPM - VDC)

CFM	AVAILABLE EXTERNAL STATIC PRESSURE (in. wg)									
	0.2		0.4		0.6		0.8		1.0	
	RPM	Vdc	RPM	Vdc	RPM	Vdc	RPM	Vdc	RPM	Vdc
1500	1387	4.9	1560	5.5	1711	6.0	1845	6.5	1966	6.9
1625	1473	5.2	1638	5.8	1784	6.3	1915	6.8	2034	7.2
1750	1561	5.5	1717	6.1	1858	6.6	1986	7.0	2103	7.4
1875	1650	5.8	1798	6.3	1934	6.8	2059	7.3	2174	7.7
2000	1741	6.1	1881	6.6	2012	7.1	2133	7.5	2246	7.9
2125	1832	6.5	1965	6.9	2091	7.4	2209	7.8	2319	8.2
2250	1925	6.8	2050	7.2	2172	7.7	2286	8.1	2394	8.4
2375	2018	7.1	2137	7.5	2254	7.9	2364	8.3	2469	8.7
2500	2113	7.5	2225	7.8	2337	8.2	2444	8.6	2547	9.0

CFM	AVAILABLE EXTERNAL STATIC PRESSURE (in. wg)									
	1.2		1.4		1.6		1.8		2.0	
	RPM	Vdc	RPM	Vdc	RPM	Vdc	RPM	Vdc	RPM	Vdc
1500	2079	7.3	2185	7.7	2285	8.1	2381	8.4	2473	8.7
1625	2144	7.6	2248	7.9	2346	8.3	2440	8.6	2530	8.9
1750	2212	7.8	2313	8.2	2410	8.5	2502	8.8	2590	9.1
1875	2281	8.0	2381	8.4	2475	8.7	2566	9.0	2653	9.4
2000	2351	8.3	2449	8.6	2543	9.0	2632	9.3	2717	9.6
2125	2422	8.5	2519	8.9	2611	9.2	2699	9.5	2783	9.8
2250	2495	8.8	2590	9.1	2681	9.5	2767	9.8	—	—
2375	2569	9.1	2663	9.4	2752	9.7	—	—	—	—
2500	2643	9.3	2736	9.6	2824	10.0	—	—	—	—

High Static 1387-2836 RPM

NOTE: Fan tables include highest gas heat. Utilize static pressure gain tables for lower gas heat capacities.

48GC**04 SINGLE PHASE — 3 TON HORIZONTAL SUPPLY (RPM - BHP)

CFM	AVAILABLE EXTERNAL STATIC PRESSURE (in. wg)									
	0.2		0.4		0.6		0.8		1.0	
	RPM	BHP	RPM	BHP	RPM	BHP	RPM	BHP	RPM	BHP
900	1097	0.09	1331	0.16	1524	0.25	1692	0.34	1842	0.44
975	1146	0.10	1373	0.18	1562	0.27	1728	0.36	1877	0.46
1050	1197	0.12	1416	0.20	1601	0.29	1765	0.38	1912	0.49
1125	1249	0.14	1460	0.22	1642	0.31	1803	0.41	1949	0.52
1200	1303	0.15	1506	0.24	1684	0.33	1842	0.44	1986	0.55
1275	1359	0.17	1553	0.26	1727	0.36	1883	0.46	2025	0.58
1350	1415	0.20	1602	0.29	1771	0.39	1925	0.50	2064	0.61
1425	1472	0.22	1652	0.31	1817	0.42	1967	0.53	2105	0.65
1500	1530	0.25	1703	0.34	1863	0.45	2010	0.57	2147	0.69

CFM	AVAILABLE EXTERNAL STATIC PRESSURE (in. wg)									
	1.2		1.4		1.6		1.8		2.0	
	RPM	BHP	RPM	BHP	RPM	BHP	RPM	BHP	RPM	BHP
900	1980	0.54	2107	0.65	2225	0.77	2337	0.89	2443	1.02
975	2013	0.57	2139	0.68	2258	0.80	2369	0.93	2475	1.06
1050	2048	0.60	2173	0.71	2291	0.84	2401	0.96	—	—
1125	2083	0.63	2207	0.75	2324	0.87	2435	1.01	—	—
1200	2119	0.66	2242	0.78	2359	0.91	2468	1.05	—	—
1275	2156	0.70	2278	0.82	2394	0.96	—	—	—	—
1350	2194	0.74	2315	0.86	2429	1.00	—	—	—	—
1425	2233	0.78	2353	0.91	2466	1.04	—	—	—	—
1500	2273	0.82	2391	0.95	—	—	—	—	—	—

- Standard Static 1097-1890 RPM, 0.44 Max BHP
- Medium Static 1097-2190 RPM, 0.71 Max BHP
- High Static 1097-2490 RPM, 1.07 Max BHP

NOTE: Fan tables include highest gas heat. Utilize static pressure gain tables for lower gas heat capacities.

48GC**04 SINGLE PHASE - STANDARD STATIC — 3 TON HORIZONTAL SUPPLY (RPM - VDC)

CFM	AVAILABLE EXTERNAL STATIC PRESSURE (in. wg)									
	0.2		0.4		0.6		0.8		1.0	
	RPM	Vdc	RPM	Vdc	RPM	Vdc	RPM	Vdc	RPM	Vdc
900	1097	5.8	1331	7.0	1524	8.1	1692	9.0	1842	9.7
975	1146	6.1	1373	7.3	1562	8.3	1728	9.1	—	—
1050	1197	6.3	1416	7.5	1601	8.5	1765	9.3	—	—
1125	1249	6.6	1460	7.7	1642	8.7	1803	9.5	—	—
1200	1303	6.9	1506	8.0	1684	8.9	1842	9.7	—	—
1275	1359	7.2	1553	8.2	1727	9.1	—	—	—	—
1350	1415	7.5	1602	8.5	1771	9.4	—	—	—	—
1425	1472	7.8	1652	8.7	1817	9.6	—	—	—	—
1500	1530	8.1	1703	9.0	—	—	—	—	—	—

CFM	AVAILABLE EXTERNAL STATIC PRESSURE (in. wg)									
	1.2		1.4		1.6		1.8		2.0	
	RPM	Vdc	RPM	Vdc	RPM	Vdc	RPM	Vdc	RPM	Vdc
900	—	—	—	—	—	—	—	—	—	—
975	—	—	—	—	—	—	—	—	—	—
1050	—	—	—	—	—	—	—	—	—	—
1125	—	—	—	—	—	—	—	—	—	—
1200	—	—	—	—	—	—	—	—	—	—
1275	—	—	—	—	—	—	—	—	—	—
1350	—	—	—	—	—	—	—	—	—	—
1425	—	—	—	—	—	—	—	—	—	—
1500	—	—	—	—	—	—	—	—	—	—

- Standard Static 1097-1890 RPM

NOTE: Fan tables include highest gas heat. Utilize static pressure gain tables for lower gas heat capacities.

48GC**04 SINGLE PHASE - MEDIUM STATIC — 3 TON HORIZONTAL SUPPLY (RPM - VDC)

CFM	AVAILABLE EXTERNAL STATIC PRESSURE (in. wg)									
	0.2		0.4		0.6		0.8		1.0	
	RPM	Vdc	RPM	Vdc	RPM	Vdc	RPM	Vdc	RPM	Vdc
900	1097	5.0	1331	6.1	1524	7.0	1692	7.7	1842	8.4
975	1146	5.2	1373	6.3	1562	7.1	1728	7.9	1877	8.6
1050	1197	5.5	1416	6.5	1601	7.3	1765	8.1	1912	8.7
1125	1249	5.7	1460	6.7	1642	7.5	1803	8.2	1949	8.9
1200	1303	5.9	1506	6.9	1684	7.7	1842	8.4	1986	9.1
1275	1359	6.2	1553	7.1	1727	7.9	1883	8.6	2025	9.2
1350	1415	6.5	1602	7.3	1771	8.1	1925	8.8	2064	9.4
1425	1472	6.7	1652	7.5	1817	8.3	1967	9.0	2105	9.6
1500	1530	7.0	1703	7.8	1863	8.5	2010	9.2	2147	9.8

CFM	AVAILABLE EXTERNAL STATIC PRESSURE (in. wg)									
	1.2		1.4		1.6		1.8		2.0	
	RPM	Vdc	RPM	Vdc	RPM	Vdc	RPM	Vdc	RPM	Vdc
900	1980	9.0	2107	9.6	—	—	—	—	—	—
975	2013	9.2	2139	9.8	—	—	—	—	—	—
1050	2048	9.4	2173	9.9	—	—	—	—	—	—
1125	2083	9.5	—	—	—	—	—	—	—	—
1200	2119	9.7	—	—	—	—	—	—	—	—
1275	2156	9.8	—	—	—	—	—	—	—	—
1350	—	—	—	—	—	—	—	—	—	—
1425	—	—	—	—	—	—	—	—	—	—
1500	—	—	—	—	—	—	—	—	—	—

Medium Static 1097-2190 RPM

NOTE: Fan tables include highest gas heat. Utilize static pressure gain tables for lower gas heat capacities.

48GC**04 SINGLE PHASE - HIGH STATIC — 3 TON HORIZONTAL SUPPLY (RPM - VDC)

CFM	AVAILABLE EXTERNAL STATIC PRESSURE (in. wg)									
	0.2		0.4		0.6		0.8		1.0	
	RPM	Vdc	RPM	Vdc	RPM	Vdc	RPM	Vdc	RPM	Vdc
900	1097	4.4	1331	5.3	1524	6.1	1692	6.8	1842	7.4
975	1146	4.6	1373	5.5	1562	6.3	1728	6.9	1877	7.5
1050	1197	4.8	1416	5.7	1601	6.4	1765	7.1	1912	7.7
1125	1249	5.0	1460	5.9	1642	6.6	1803	7.2	1949	7.8
1200	1303	5.2	1506	6.0	1684	6.8	1842	7.4	1986	8.0
1275	1359	5.5	1553	6.2	1727	6.9	1883	7.6	2025	8.1
1350	1415	5.7	1602	6.4	1771	7.1	1925	7.7	2064	8.3
1425	1472	5.9	1652	6.6	1817	7.3	1967	7.9	2105	8.5
1500	1530	6.1	1703	6.8	1863	7.5	2010	8.1	2147	8.6

CFM	AVAILABLE EXTERNAL STATIC PRESSURE (in. wg)									
	1.2		1.4		1.6		1.8		2.0	
	RPM	Vdc	RPM	Vdc	RPM	Vdc	RPM	Vdc	RPM	Vdc
900	1980	8.0	2107	8.5	2225	8.9	2337	9.4	2443	9.8
975	2013	8.1	2139	8.6	2258	9.1	2369	9.5	2475	9.9
1050	2048	8.2	2173	8.7	2291	9.2	2401	9.6	—	—
1125	2083	8.4	2207	8.9	2324	9.3	2435	9.8	—	—
1200	2119	8.5	2242	9.0	2359	9.5	2468	9.9	—	—
1275	2156	8.7	2278	9.1	2394	9.6	—	—	—	—
1350	2194	8.8	2315	9.3	2429	9.8	—	—	—	—
1425	2233	9.0	2353	9.4	2466	9.9	—	—	—	—
1500	2273	9.1	2391	9.6	—	—	—	—	—	—

High Static 1097-2490 RPM

NOTE: Fan tables include highest gas heat. Utilize static pressure gain tables for lower gas heat capacities.

48GC**04 THREE PHASE — 3 TON HORIZONTAL SUPPLY (RPM - BHP)

CFM	AVAILABLE EXTERNAL STATIC PRESSURE (in. wg)									
	0.2		0.4		0.6		0.8		1.0	
	RPM	BHP	RPM	BHP	RPM	BHP	RPM	BHP	RPM	BHP
900	1097	0.09	1331	0.16	1524	0.25	1692	0.34	1842	0.44
975	1146	0.10	1373	0.18	1562	0.27	1728	0.36	1877	0.46
1050	1197	0.12	1416	0.20	1601	0.29	1765	0.38	1912	0.49
1125	1249	0.14	1460	0.22	1642	0.31	1803	0.41	1949	0.52
1200	1303	0.15	1506	0.24	1684	0.33	1842	0.44	1986	0.55
1275	1359	0.17	1553	0.26	1727	0.36	1883	0.46	2025	0.58
1350	1415	0.20	1602	0.29	1771	0.39	1925	0.50	2064	0.61
1425	1472	0.22	1652	0.31	1817	0.42	1967	0.53	2105	0.65
1500	1530	0.25	1703	0.34	1863	0.45	2010	0.57	2147	0.69

CFM	AVAILABLE EXTERNAL STATIC PRESSURE (in. wg)									
	1.2		1.4		1.6		1.8		2.0	
	RPM	BHP	RPM	BHP	RPM	BHP	RPM	BHP	RPM	BHP
900	1980	0.54	2107	0.65	2225	0.77	2337	0.89	2443	1.02
975	2013	0.57	2139	0.68	2258	0.80	2369	0.93	2475	1.06
1050	2048	0.60	2173	0.71	2291	0.84	2401	0.96	—	—
1125	2083	0.63	2207	0.75	2324	0.87	2435	1.01	—	—
1200	2119	0.66	2242	0.78	2359	0.91	2468	1.05	—	—
1275	2156	0.70	2278	0.82	2394	0.96	—	—	—	—
1350	2194	0.74	2315	0.86	2429	1.00	—	—	—	—
1425	2233	0.78	2353	0.91	2466	1.04	—	—	—	—
1500	2273	0.82	2391	0.95	—	—	—	—	—	—

- Standard Static 1097-1890 RPM, 0.44 Max BHP
- Medium Static 1097-2190 RPM, 0.71 Max BHP
- High Static 1097-2490 RPM, 1.07 Max BHP

NOTE: Fan tables include highest gas heat. Utilize static pressure gain tables for lower gas heat capacities.

48GC**04 THREE PHASE - STANDARD STATIC — 3 TON HORIZONTAL SUPPLY (RPM - VDC)

CFM	AVAILABLE EXTERNAL STATIC PRESSURE (in. wg)									
	0.2		0.4		0.6		0.8		1.0	
	RPM	Vdc	RPM	Vdc	RPM	Vdc	RPM	Vdc	RPM	Vdc
900	1097	5.8	1331	7.0	1524	8.1	1692	9.0	1842	9.7
975	1146	6.1	1373	7.3	1562	8.3	1728	9.1	—	—
1050	1197	6.3	1416	7.5	1601	8.5	1765	9.3	—	—
1125	1249	6.6	1460	7.7	1642	8.7	1803	9.5	—	—
1200	1303	6.9	1506	8.0	1684	8.9	1842	9.7	—	—
1275	1359	7.2	1553	8.2	1727	9.1	—	—	—	—
1350	1415	7.5	1602	8.5	1771	9.4	—	—	—	—
1425	1472	7.8	1652	8.7	1817	9.6	—	—	—	—
1500	1530	8.1	1703	9.0	—	—	—	—	—	—

CFM	AVAILABLE EXTERNAL STATIC PRESSURE (in. wg)									
	1.2		1.4		1.6		1.8		2.0	
	RPM	Vdc	RPM	Vdc	RPM	Vdc	RPM	Vdc	RPM	Vdc
900	—	—	—	—	—	—	—	—	—	—
975	—	—	—	—	—	—	—	—	—	—
1050	—	—	—	—	—	—	—	—	—	—
1125	—	—	—	—	—	—	—	—	—	—
1200	—	—	—	—	—	—	—	—	—	—
1275	—	—	—	—	—	—	—	—	—	—
1350	—	—	—	—	—	—	—	—	—	—
1425	—	—	—	—	—	—	—	—	—	—
1500	—	—	—	—	—	—	—	—	—	—

- Standard Static 1097-1890 RPM

NOTE: Fan tables include highest gas heat. Utilize static pressure gain tables for lower gas heat capacities.

48GC**04 THREE PHASE - MEDIUM STATIC — 3 TON HORIZONTAL SUPPLY (RPM - VDC)

CFM	AVAILABLE EXTERNAL STATIC PRESSURE (in. wg)									
	0.2		0.4		0.6		0.8		1.0	
	RPM	Vdc	RPM	Vdc	RPM	Vdc	RPM	Vdc	RPM	Vdc
900	1097	5.0	1331	6.1	1524	7.0	1692	7.7	1842	8.4
975	1146	5.2	1373	6.3	1562	7.1	1728	7.9	1877	8.6
1050	1197	5.5	1416	6.5	1601	7.3	1765	8.1	1912	8.7
1125	1249	5.7	1460	6.7	1642	7.5	1803	8.2	1949	8.9
1200	1303	5.9	1506	6.9	1684	7.7	1842	8.4	1986	9.1
1275	1359	6.2	1553	7.1	1727	7.9	1883	8.6	2025	9.2
1350	1415	6.5	1602	7.3	1771	8.1	1925	8.8	2064	9.4
1425	1472	6.7	1652	7.5	1817	8.3	1967	9.0	2105	9.6
1500	1530	7.0	1703	7.8	1863	8.5	2010	9.2	2147	9.8

CFM	AVAILABLE EXTERNAL STATIC PRESSURE (in. wg)									
	1.2		1.4		1.6		1.8		2.0	
	RPM	Vdc	RPM	Vdc	RPM	Vdc	RPM	Vdc	RPM	Vdc
900	1980	9.0	2107	9.6	—	—	—	—	—	—
975	2013	9.2	2139	9.8	—	—	—	—	—	—
1050	2048	9.4	2173	9.9	—	—	—	—	—	—
1125	2083	9.5	—	—	—	—	—	—	—	—
1200	2119	9.7	—	—	—	—	—	—	—	—
1275	2156	9.8	—	—	—	—	—	—	—	—
1350	—	—	—	—	—	—	—	—	—	—
1425	—	—	—	—	—	—	—	—	—	—
1500	—	—	—	—	—	—	—	—	—	—

Medium Static 1097-2190 RPM

NOTE: Fan tables include highest gas heat. Utilize static pressure gain tables for lower gas heat capacities.

48GC**04 THREE PHASE - HIGH STATIC — 3 TON HORIZONTAL SUPPLY (RPM - VDC)

CFM	AVAILABLE EXTERNAL STATIC PRESSURE (in. wg)									
	0.2		0.4		0.6		0.8		1.0	
	RPM	Vdc	RPM	Vdc	RPM	Vdc	RPM	Vdc	RPM	Vdc
900	1097	4.4	1331	5.3	1524	6.1	1692	6.8	1842	7.4
975	1146	4.6	1373	5.5	1562	6.3	1728	6.9	1877	7.5
1050	1197	4.8	1416	5.7	1601	6.4	1765	7.1	1912	7.7
1125	1249	5.0	1460	5.9	1642	6.6	1803	7.2	1949	7.8
1200	1303	5.2	1506	6.0	1684	6.8	1842	7.4	1986	8.0
1275	1359	5.5	1553	6.2	1727	6.9	1883	7.6	2025	8.1
1350	1415	5.7	1602	6.4	1771	7.1	1925	7.7	2064	8.3
1425	1472	5.9	1652	6.6	1817	7.3	1967	7.9	2105	8.5
1500	1530	6.1	1703	6.8	1863	7.5	2010	8.1	2147	8.6

CFM	AVAILABLE EXTERNAL STATIC PRESSURE (in. wg)									
	1.2		1.4		1.6		1.8		2.0	
	RPM	Vdc	RPM	Vdc	RPM	Vdc	RPM	Vdc	RPM	Vdc
900	1980	8.0	2107	8.5	2225	8.9	2337	9.4	2443	9.8
975	2013	8.1	2139	8.6	2258	9.1	2369	9.5	2475	9.9
1050	2048	8.2	2173	8.7	2291	9.2	2401	9.6	—	—
1125	2083	8.4	2207	8.9	2324	9.3	2435	9.8	—	—
1200	2119	8.5	2242	9.0	2359	9.5	2468	9.9	—	—
1275	2156	8.7	2278	9.1	2394	9.6	—	—	—	—
1350	2194	8.8	2315	9.3	2429	9.8	—	—	—	—
1425	2233	9.0	2353	9.4	2466	9.9	—	—	—	—
1500	2273	9.1	2391	9.6	—	—	—	—	—	—

High Static 1097-2490 RPM

NOTE: Fan tables include highest gas heat. Utilize static pressure gain tables for lower gas heat capacities.

48GC**05 SINGLE PHASE — 4 TON HORIZONTAL SUPPLY (RPM - BHP)

CFM	AVAILABLE EXTERNAL STATIC PRESSURE (in. wg)									
	0.2		0.4		0.6		0.8		1.0	
	RPM	BHP	RPM	BHP	RPM	BHP	RPM	BHP	RPM	BHP
1200	1217	0.19	1411	0.30	1576	0.42	1722	0.55	1855	0.68
1300	1283	0.23	1470	0.34	1631	0.46	1774	0.60	1904	0.74
1400	1351	0.26	1531	0.38	1688	0.51	1827	0.65	1955	0.80
1500	1420	0.31	1593	0.43	1746	0.57	1883	0.71	2008	0.86
1600	1491	0.35	1657	0.48	1805	0.63	1939	0.78	2062	0.93
1700	1563	0.41	1722	0.54	1866	0.69	1997	0.85	2118	1.01
1800	1635	0.46	1789	0.61	1928	0.76	2056	0.92	2174	1.09
1900	1709	0.53	1856	0.68	1991	0.84	2116	1.01	2232	1.18
2000	1784	0.60	1925	0.76	2056	0.92	2178	1.10	2291	1.28

CFM	AVAILABLE EXTERNAL STATIC PRESSURE (in. wg)									
	1.2		1.4		1.6		1.8		2.0	
	RPM	BHP	RPM	BHP	RPM	BHP	RPM	BHP	RPM	BHP
1200	1978	0.83	2094	0.98	2204	1.15	2308	1.32	2409	1.50
1300	2025	0.89	2138	1.05	2246	1.21	2349	1.39	2447	1.57
1400	2074	0.95	2185	1.11	2291	1.28	2391	1.46	—	—
1500	2124	1.02	2234	1.19	2338	1.36	2436	1.54	—	—
1600	2176	1.10	2284	1.27	2386	1.45	—	—	—	—
1700	2230	1.18	2336	1.36	2436	1.54	—	—	—	—
1800	2285	1.27	2389	1.45	—	—	—	—	—	—
1900	2341	1.36	2444	1.55	—	—	—	—	—	—
2000	2398	1.46	—	—	—	—	—	—	—	—

- Standard Static 1217-1900 RPM, 0.72 Max BHP
- Medium Static 1217-2170 RPM, 1.06 Max BHP
- High Static 1217-2460 RPM, 1.53, Max BHP

NOTE: Fan tables include highest gas heat. Utilize static pressure gain tables for lower gas heat capacities.

48GC**05 SINGLE PHASE - STANDARD STATIC — 4 TON HORIZONTAL SUPPLY (RPM - VDC)

CFM	AVAILABLE EXTERNAL STATIC PRESSURE (in. wg)									
	0.2		0.4		0.6		0.8		1.0	
	RPM	Vdc	RPM	Vdc	RPM	Vdc	RPM	Vdc	RPM	Vdc
1200	1217	6.4	1411	7.4	1576	8.3	1722	9.1	1855	9.8
1300	1283	6.8	1470	7.7	1631	8.6	1774	9.3	—	—
1400	1351	7.1	1531	8.1	1688	8.9	1827	9.6	—	—
1500	1420	7.5	1593	8.4	1746	9.2	1883	9.9	—	—
1600	1491	7.8	1657	8.7	1805	9.5	—	—	—	—
1700	1563	8.2	1722	9.1	1866	9.8	—	—	—	—
1800	1635	8.6	1789	9.4	—	—	—	—	—	—
1900	1709	9.0	1856	9.8	—	—	—	—	—	—
2000	1784	9.4	—	—	—	—	—	—	—	—

CFM	AVAILABLE EXTERNAL STATIC PRESSURE (in. wg)									
	1.2		1.4		1.6		1.8		2.0	
	RPM	Vdc	RPM	Vdc	RPM	Vdc	RPM	Vdc	RPM	Vdc
1200	—	—	—	—	—	—	—	—	—	—
1300	—	—	—	—	—	—	—	—	—	—
1400	—	—	—	—	—	—	—	—	—	—
1500	—	—	—	—	—	—	—	—	—	—
1600	—	—	—	—	—	—	—	—	—	—
1700	—	—	—	—	—	—	—	—	—	—
1800	—	—	—	—	—	—	—	—	—	—
1900	—	—	—	—	—	—	—	—	—	—
2000	—	—	—	—	—	—	—	—	—	—

- Standard Static 1217-1990 RPM

NOTE: Fan tables include highest gas heat. Utilize static pressure gain tables for lower gas heat capacities.

48GC**05 SINGLE PHASE - MEDIUM STATIC — 4 TON HORIZONTAL SUPPLY (RPM - VDC)

CFM	AVAILABLE EXTERNAL STATIC PRESSURE (in. wg)									
	0.2		0.4		0.6		0.8		1.0	
	RPM	Vdc	RPM	Vdc	RPM	Vdc	RPM	Vdc	RPM	Vdc
1200	1217	5.6	1411	6.5	1576	7.3	1722	7.9	1855	8.5
1300	1283	5.9	1470	6.8	1631	7.5	1774	8.2	1904	8.8
1400	1351	6.2	1531	7.1	1688	7.8	1827	8.4	1955	9.0
1500	1420	6.5	1593	7.3	1746	8.0	1883	8.7	2008	9.3
1600	1491	6.9	1657	7.6	1805	8.3	1939	8.9	2062	9.5
1700	1563	7.2	1722	7.9	1866	8.6	1997	9.2	2118	9.8
1800	1635	7.5	1789	8.2	1928	8.9	2056	9.5	—	—
1900	1709	7.9	1856	8.6	1991	9.2	2116	9.8	—	—
2000	1784	8.2	1925	8.9	2056	9.5	—	—	—	—

CFM	AVAILABLE EXTERNAL STATIC PRESSURE (in. wg)									
	1.2		1.4		1.6		1.8		2.0	
	RPM	Vdc	RPM	Vdc	RPM	Vdc	RPM	Vdc	RPM	Vdc
1200	1978	9.1	2094	9.6	—	—	—	—	—	—
1300	2025	9.3	2138	9.9	—	—	—	—	—	—
1400	2074	9.6	—	—	—	—	—	—	—	—
1500	2124	9.8	—	—	—	—	—	—	—	—
1600	—	—	—	—	—	—	—	—	—	—
1700	—	—	—	—	—	—	—	—	—	—
1800	—	—	—	—	—	—	—	—	—	—
1900	—	—	—	—	—	—	—	—	—	—
2000	—	—	—	—	—	—	—	—	—	—

Medium Static 1217-2170 RPM, 1.06 Max BHP

NOTE: Fan tables include highest gas heat. Utilize static pressure gain tables for lower gas heat capacities.

48GC**05 SINGLE PHASE - HIGH STATIC — 4 TON HORIZONTAL SUPPLY (RPM - VDC)

CFM	AVAILABLE EXTERNAL STATIC PRESSURE (in. wg)									
	0.2		0.4		0.6		0.8		1.0	
	RPM	Vdc	RPM	Vdc	RPM	Vdc	RPM	Vdc	RPM	Vdc
1200	1217	4.9	1411	5.7	1576	6.4	1722	7.0	1855	7.5
1300	1283	5.2	1470	6.0	1631	6.6	1774	7.2	1904	7.7
1400	1351	5.5	1531	6.2	1688	6.9	1827	7.4	1955	7.9
1500	1420	5.8	1593	6.5	1746	7.1	1883	7.7	2008	8.2
1600	1491	6.1	1657	6.7	1805	7.3	1939	7.9	2062	8.4
1700	1563	6.4	1722	7.0	1866	7.6	1997	8.1	2118	8.6
1800	1635	6.6	1789	7.3	1928	7.8	2056	8.4	2174	8.8
1900	1709	6.9	1856	7.5	1991	8.1	2116	8.6	2232	9.1
2000	1784	7.3	1925	7.8	2056	8.4	2178	8.9	2291	9.3

CFM	AVAILABLE EXTERNAL STATIC PRESSURE (in. wg)									
	1.2		1.4		1.6		1.8		2.0	
	RPM	Vdc	RPM	Vdc	RPM	Vdc	RPM	Vdc	RPM	Vdc
1200	1978	8.0	2094	8.5	2204	9.0	2308	9.4	2409	9.8
1300	2025	8.2	2138	8.7	2246	9.1	2349	9.5	2447	9.9
1400	2074	8.4	2185	8.9	2291	9.3	2391	9.7	—	—
1500	2124	8.6	2234	9.1	2338	9.5	2436	9.9	—	—
1600	2176	8.8	2284	9.3	2386	9.7	—	—	—	—
1700	2230	9.1	2336	9.5	2436	9.9	—	—	—	—
1800	2285	9.3	2389	9.7	—	—	—	—	—	—
1900	2341	9.5	2444	9.9	—	—	—	—	—	—
2000	2398	9.7	—	—	—	—	—	—	—	—

High Static 1217-2460 RPM1.53, Max BHP

NOTE: Fan tables include highest gas heat. Utilize static pressure gain tables for lower gas heat capacities.

48GC**05 THREE PHASE — 4 TON HORIZONTAL SUPPLY (RPM - BHP)

CFM	AVAILABLE EXTERNAL STATIC PRESSURE (in. wg)									
	0.2		0.4		0.6		0.8		1.0	
	RPM	BHP	RPM	BHP	RPM	BHP	RPM	BHP	RPM	BHP
1200	1216	0.19	1411	0.30	1576	0.42	1722	0.55	1855	0.68
1300	1283	0.23	1470	0.34	1631	0.46	1774	0.60	1904	0.74
1400	1351	0.26	1531	0.38	1687	0.51	1827	0.65	1955	0.80
1500	1420	0.31	1593	0.43	1746	0.57	1882	0.71	2008	0.86
1600	1491	0.35	1657	0.48	1806	0.63	1939	0.78	2062	0.93
1700	1562	0.41	1722	0.54	1866	0.69	1998	0.85	2117	1.01
1800	1636	0.47	1788	0.61	1928	0.76	2056	0.92	2175	1.09
1900	1710	0.53	1856	0.68	1991	0.84	2117	1.01	2233	1.18
2000	1784	0.60	1924	0.76	2055	0.92	2178	1.10	2292	1.28

CFM	AVAILABLE EXTERNAL STATIC PRESSURE (in. wg)									
	1.2		1.4		1.6		1.8		2.0	
	RPM	BHP	RPM	BHP	RPM	BHP	RPM	BHP	RPM	BHP
1200	1978	0.83	2094	0.98	2204	1.15	2308	1.32	2409	1.50
1300	2025	0.89	2138	1.05	2246	1.21	2349	1.39	2447	1.57
1400	2073	0.95	2185	1.11	2291	1.28	2392	1.46	2488	1.64
1500	2124	1.02	2233	1.19	2338	1.36	2437	1.54	2532	1.73
1600	2176	1.10	2284	1.27	2386	1.45	2483	1.63	2577	1.82
1700	2230	1.18	2336	1.36	2436	1.54	2532	1.73	2624	1.92
1800	2285	1.27	2389	1.45	2488	1.64	2582	1.83	—	—
1900	2341	1.36	2443	1.55	2541	1.74	2634	1.94	—	—
2000	2399	1.46	2499	1.66	2595	1.85	—	—	—	—

- Standard Static 1216-1900 RPM, 0.72 Max BHP
- Medium Static 1216-2170 RPM, 1.06 Max BHP
- High Static 1216-2660 RPM, 1.96 Max BHP

NOTE: Fan tables include highest gas heat. Utilize static pressure gain tables for lower gas heat capacities.

48GC**05 THREE PHASE - STANDARD STATIC — 4 TON HORIZONTAL SUPPLY (RPM - VDC)

CFM	AVAILABLE EXTERNAL STATIC PRESSURE (in. wg)									
	0.2		0.4		0.6		0.8		1.0	
	RPM	Vdc	RPM	Vdc	RPM	Vdc	RPM	Vdc	RPM	Vdc
1200	1216	6.4	1411	7.4	1576	8.3	1722	9.1	1855	9.8
1300	1283	6.8	1470	7.7	1631	8.6	1774	9.3	—	—
1400	1351	7.1	1531	8.1	1687	8.9	1827	9.6	—	—
1500	1420	7.5	1593	8.4	1746	9.2	1882	9.9	—	—
1600	1491	7.8	1657	8.7	1806	9.5	—	—	—	—
1700	1562	8.2	1722	9.1	1866	9.8	—	—	—	—
1800	1636	8.6	1788	9.4	—	—	—	—	—	—
1900	1710	9.0	1856	9.8	—	—	—	—	—	—
2000	1784	9.4	—	—	—	—	—	—	—	—

CFM	AVAILABLE EXTERNAL STATIC PRESSURE (in. wg)									
	1.2		1.4		1.6		1.8		2.0	
	RPM	Vdc	RPM	Vdc	RPM	Vdc	RPM	Vdc	RPM	Vdc
1200	—	—	—	—	—	—	—	—	—	—
1300	—	—	—	—	—	—	—	—	—	—
1400	—	—	—	—	—	—	—	—	—	—
1500	—	—	—	—	—	—	—	—	—	—
1600	—	—	—	—	—	—	—	—	—	—
1700	—	—	—	—	—	—	—	—	—	—
1800	—	—	—	—	—	—	—	—	—	—
1900	—	—	—	—	—	—	—	—	—	—
2000	—	—	—	—	—	—	—	—	—	—

- Standard Static 1216-1900 RPM

NOTE: Fan tables include highest gas heat. Utilize static pressure gain tables for lower gas heat capacities.

48GC**05 THREE PHASE - MEDIUM STATIC — 4 TON HORIZONTAL SUPPLY (RPM - VDC)

CFM	AVAILABLE EXTERNAL STATIC PRESSURE (in. wg)									
	0.2		0.4		0.6		0.8		1.0	
	RPM	Vdc	RPM	Vdc	RPM	Vdc	RPM	Vdc	RPM	Vdc
1200	1216	5.6	1411	6.5	1576	7.3	1722	7.9	1855	8.5
1300	1283	5.9	1470	6.8	1631	7.5	1774	8.2	1904	8.8
1400	1351	6.2	1531	7.1	1687	7.8	1827	8.4	1955	9.0
1500	1420	6.5	1593	7.3	1746	8.0	1882	8.7	2008	9.3
1600	1491	6.9	1657	7.6	1806	8.3	1939	8.9	2062	9.5
1700	1562	7.2	1722	7.9	1866	8.6	1998	9.2	2117	9.8
1800	1636	7.5	1788	8.2	1928	8.9	2056	9.5	—	—
1900	1710	7.9	1856	8.6	1991	9.2	2117	9.8	—	—
2000	1784	8.2	1924	8.9	2055	9.5	—	—	—	—

CFM	AVAILABLE EXTERNAL STATIC PRESSURE (in. wg)									
	1.2		1.4		1.6		1.8		2.0	
	RPM	Vdc	RPM	Vdc	RPM	Vdc	RPM	Vdc	RPM	Vdc
1200	1978	9.1	2094	9.6	—	—	—	—	—	—
1300	2025	9.3	2138	9.9	—	—	—	—	—	—
1400	2073	9.6	—	—	—	—	—	—	—	—
1500	2124	9.8	—	—	—	—	—	—	—	—
1600	—	—	—	—	—	—	—	—	—	—
1700	—	—	—	—	—	—	—	—	—	—
1800	—	—	—	—	—	—	—	—	—	—
1900	—	—	—	—	—	—	—	—	—	—
2000	—	—	—	—	—	—	—	—	—	—

Medium Static 1216-2170 RPM

NOTE: Fan tables include highest gas heat. Utilize static pressure gain tables for lower gas heat capacities.

48GC**05 THREE PHASE - HIGH STATIC — 4 TON HORIZONTAL SUPPLY (RPM - VDC)

CFM	AVAILABLE EXTERNAL STATIC PRESSURE (in. wg)									
	0.2		0.4		0.6		0.8		1.0	
	RPM	Vdc	RPM	Vdc	RPM	Vdc	RPM	Vdc	RPM	Vdc
1200	1216	4.6	1411	5.3	1576	5.9	1722	6.5	1855	7.0
1300	1283	4.8	1470	5.5	1631	6.1	1774	6.7	1904	7.2
1400	1351	5.1	1531	5.8	1687	6.3	1827	6.9	1955	7.3
1500	1420	5.3	1593	6.0	1746	6.6	1882	7.1	2008	7.5
1600	1491	5.6	1657	6.2	1806	6.8	1939	7.3	2062	7.8
1700	1562	5.9	1722	6.5	1866	7.0	1998	7.5	2117	8.0
1800	1636	6.2	1788	6.7	1928	7.2	2056	7.7	2175	8.2
1900	1710	6.4	1856	7.0	1991	7.5	2117	8.0	2233	8.4
2000	1784	6.7	1924	7.2	2055	7.7	2178	8.2	2292	8.6

CFM	AVAILABLE EXTERNAL STATIC PRESSURE (in. wg)									
	1.2		1.4		1.6		1.8		2.0	
	RPM	Vdc	RPM	Vdc	RPM	Vdc	RPM	Vdc	RPM	Vdc
1200	1978	7.4	2094	7.9	2204	8.3	2308	8.7	2409	9.1
1300	2025	7.6	2138	8.0	2246	8.4	2349	8.8	2447	9.2
1400	2073	7.8	2185	8.2	2291	8.6	2392	9.0	2488	9.4
1500	2124	8.0	2233	8.4	2338	8.8	2437	9.2	2532	9.5
1600	2176	8.2	2284	8.6	2386	9.0	2483	9.3	2577	9.7
1700	2230	8.4	2336	8.8	2436	9.2	2532	9.5	2624	9.9
1800	2285	8.6	2389	9.0	2488	9.4	2582	9.7	—	—
1900	2341	8.8	2443	9.2	2541	9.6	2634	9.9	—	—
2000	2399	9.0	2499	9.4	2595	9.8	—	—	—	—

High Static 1216-2660 RPM

NOTE: Fan tables include highest gas heat. Utilize static pressure gain tables for lower gas heat capacities.

48GC**06 SINGLE PHASE — 5 TON HORIZONTAL SUPPLY (RPM - BHP)

CFM	AVAILABLE EXTERNAL STATIC PRESSURE (in. wg)									
	0.2		0.4		0.6		0.8		1.0	
	RPM	BHP	RPM	BHP	RPM	BHP	RPM	BHP	RPM	BHP
1500	1335	0.25	1507	0.36	1660	0.49	1796	0.61	1921	0.75
1625	1417	0.30	1580	0.42	1727	0.55	1860	0.68	1982	0.82
1750	1502	0.36	1654	0.48	1796	0.61	1926	0.76	2046	0.91
1875	1589	0.42	1731	0.55	1867	0.69	1993	0.84	2110	0.99
2000	1677	0.50	1810	0.63	1940	0.77	2062	0.92	2177	1.09
2125	1765	0.58	1890	0.71	2015	0.86	2133	1.02	2244	1.19
2250	1855	0.67	1972	0.81	2091	0.96	2206	1.13	2314	1.31
2375	1946	0.78	2057	0.92	2169	1.07	2279	1.25	2385	1.43
2500	2038	0.89	2142	1.03	2249	1.20	2355	1.37	—	—

CFM	AVAILABLE EXTERNAL STATIC PRESSURE (in. wg)									
	1.2		1.4		1.6		1.8		2.0	
	RPM	BHP	RPM	BHP	RPM	BHP	RPM	BHP	RPM	BHP
1500	2036	0.89	2143	1.04	2245	1.20	2342	1.36	—	—
1625	2095	0.97	2201	1.13	2301	1.29	—	—	—	—
1750	2157	1.06	2261	1.22	2359	1.39	—	—	—	—
1875	2219	1.15	2322	1.32	—	—	—	—	—	—
2000	2284	1.26	2384	1.43	—	—	—	—	—	—
2125	2349	1.37	—	—	—	—	—	—	—	—
2250	—	—	—	—	—	—	—	—	—	—
2375	—	—	—	—	—	—	—	—	—	—
2500	—	—	—	—	—	—	—	—	—	—

Standard Static 1335-2150 RPM, 1.06 Max BHP

Medium Static 1335-2390 RPM, 1.44 Max BHP

NOTE: Fan tables include highest gas heat. Utilize static pressure gain tables for lower gas heat capacities.

48GC**06 SINGLE PHASE - STANDARD STATIC — 5 TON HORIZONTAL SUPPLY (RPM - VDC)

CFM	AVAILABLE EXTERNAL STATIC PRESSURE (in. wg)									
	0.2		0.4		0.6		0.8		1.0	
	RPM	Vdc	RPM	Vdc	RPM	Vdc	RPM	Vdc	RPM	Vdc
1500	1335	6.2	1507	7.0	1660	7.7	1796	8.4	1921	8.9
1625	1417	6.6	1580	7.3	1727	8.0	1860	8.7	1982	9.2
1750	1502	7.0	1654	7.7	1796	8.4	1926	9.0	2046	9.5
1875	1589	7.4	1731	8.1	1867	8.7	1993	9.3	2110	9.8
2000	1677	7.8	1810	8.4	1940	9.0	2062	9.6	—	—
2125	1765	8.2	1890	8.8	2015	9.4	2133	9.9	—	—
2250	1855	8.6	1972	9.2	2091	9.7	—	—	—	—
2375	1946	9.1	2057	9.6	—	—	—	—	—	—
2500	2038	9.5	2142	10.0	—	—	—	—	—	—

CFM	AVAILABLE EXTERNAL STATIC PRESSURE (in. wg)									
	1.2		1.4		1.6		1.8		2.0	
	RPM	Vdc	RPM	Vdc	RPM	Vdc	RPM	Vdc	RPM	Vdc
1500	2036	9.5	2143	10.0	—	—	—	—	—	—
1625	2095	9.7	—	—	—	—	—	—	—	—
1750	—	—	—	—	—	—	—	—	—	—
1875	—	—	—	—	—	—	—	—	—	—
2000	—	—	—	—	—	—	—	—	—	—
2125	—	—	—	—	—	—	—	—	—	—
2250	—	—	—	—	—	—	—	—	—	—
2375	—	—	—	—	—	—	—	—	—	—
2500	—	—	—	—	—	—	—	—	—	—

Standard Static 1335-2150 RPM

NOTE: Fan tables include highest gas heat. Utilize static pressure gain tables for lower gas heat capacities.

48GC**06 SINGLE PHASE - MEDIUM STATIC — 5 TON HORIZONTAL SUPPLY (RPM - VDC)

CFM	AVAILABLE EXTERNAL STATIC PRESSURE (in. wg)									
	0.2		0.4		0.6		0.8		1.0	
	RPM	Vdc	RPM	Vdc	RPM	Vdc	RPM	Vdc	RPM	Vdc
1500	1335	5.6	1507	6.3	1660	6.9	1796	7.5	1921	8.0
1625	1417	5.9	1580	6.6	1727	7.2	1860	7.8	1982	8.3
1750	1502	6.3	1654	6.9	1796	7.5	1926	8.1	2046	8.6
1875	1589	6.6	1731	7.2	1867	7.8	1993	8.3	2110	8.8
2000	1677	7.0	1810	7.6	1940	8.1	2062	8.6	2177	9.1
2125	1765	7.4	1890	7.9	2015	8.4	2133	8.9	2244	9.4
2250	1855	7.8	1972	8.3	2091	8.7	2206	9.2	2314	9.7
2375	1946	8.1	2057	8.6	2169	9.1	2279	9.5	2385	10.0
2500	2038	8.5	2142	9.0	2249	9.4	2355	9.9	—	—

CFM	AVAILABLE EXTERNAL STATIC PRESSURE (in. wg)									
	1.2		1.4		1.6		1.8		2.0	
	RPM	Vdc	RPM	Vdc	RPM	Vdc	RPM	Vdc	RPM	Vdc
1500	2036	8.5	2143	9.0	2245	9.4	2342	9.8	—	—
1625	2095	8.8	2201	9.2	2301	9.6	—	—	—	—
1750	2157	9.0	2261	9.5	2359	9.9	—	—	—	—
1875	2219	9.3	2322	9.7	—	—	—	—	—	—
2000	2284	9.6	2384	10.0	—	—	—	—	—	—
2125	2349	9.8	—	—	—	—	—	—	—	—
2250	—	—	—	—	—	—	—	—	—	—
2375	—	—	—	—	—	—	—	—	—	—
2500	—	—	—	—	—	—	—	—	—	—

Medium Static 1335-2390 RPM

NOTE: Fan tables include highest gas heat. Utilize static pressure gain tables for lower gas heat capacities.

48GC**06 THREE PHASE — 5 TON HORIZONTAL SUPPLY (RPM - BHP)

CFM	AVAILABLE EXTERNAL STATIC PRESSURE (in. wg)									
	0.2		0.4		0.6		0.8		1.0	
	RPM	BHP	RPM	BHP	RPM	BHP	RPM	BHP	RPM	BHP
1500	1335	0.25	1507	0.36	1660	0.49	1796	0.61	1921	0.75
1625	1418	0.30	1579	0.42	1727	0.55	1860	0.68	1982	0.82
1750	1502	0.36	1654	0.48	1797	0.61	1927	0.76	2046	0.91
1875	1589	0.42	1731	0.55	1867	0.69	1994	0.84	2111	0.99
2000	1676	0.50	1810	0.63	1940	0.77	2063	0.93	2177	1.09
2125	1765	0.58	1890	0.71	2015	0.86	2133	1.02	2245	1.19
2250	1855	0.67	1973	0.81	2091	0.96	2206	1.13	2314	1.31
2375	1946	0.78	2057	0.92	2169	1.07	2279	1.25	2385	1.43
2500	2038	0.89	2142	1.03	2249	1.20	2355	1.37	2457	1.56

CFM	AVAILABLE EXTERNAL STATIC PRESSURE (in. wg)									
	1.2		1.4		1.6		1.8		2.0	
	RPM	BHP	RPM	BHP	RPM	BHP	RPM	BHP	RPM	BHP
1500	2036	0.89	2144	1.05	2245	1.20	2342	1.36	2435	1.53
1625	2095	0.97	2201	1.13	2301	1.29	2396	1.46	2487	1.63
1750	2157	1.06	2261	1.22	2359	1.39	2453	1.56	2543	1.74
1875	2219	1.15	2322	1.32	2419	1.49	2511	1.67	2599	1.85
2000	2284	1.26	2384	1.43	2480	1.61	2571	1.79	2658	1.98
2125	2350	1.37	2449	1.55	2542	1.73	2632	1.92	2718	2.12
2250	2417	1.49	2514	1.67	2607	1.87	2695	2.06	2779	2.26
2375	2485	1.62	2581	1.81	2672	2.01	2759	2.21	—	—
2500	2555	1.76	2648	1.95	2738	2.16	2824	2.37	—	—

- Standard Static 1335-2150 RPM, 1.06 Max BHP
- Medium Static 1335-2390 RPM, 1.44 Max BHP
- High Static 1335-2836 RPM, 2.43 Max BHP

NOTE: Fan tables include highest gas heat. Utilize static pressure gain tables for lower gas heat capacities.

48GC**06 THREE PHASE - STANDARD STATIC — 5 TON HORIZONTAL SUPPLY (RPM - VDC)

CFM	AVAILABLE EXTERNAL STATIC PRESSURE (in. wg)									
	0.2		0.4		0.6		0.8		1.0	
	RPM	Vdc	RPM	Vdc	RPM	Vdc	RPM	Vdc	RPM	Vdc
1500	1335	6.2	1507	7.0	1660	7.7	1796	8.4	1921	8.9
1625	1418	6.6	1579	7.3	1727	8.0	1860	8.7	1982	9.2
1750	1502	7.0	1654	7.7	1797	8.4	1927	9.0	2046	9.5
1875	1589	7.4	1731	8.1	1867	8.7	1994	9.3	2111	9.8
2000	1676	7.8	1810	8.4	1940	9.0	2063	9.6	—	—
2125	1765	8.2	1890	8.8	2015	9.4	2133	9.9	—	—
2250	1855	8.6	1973	9.2	2091	9.7	—	—	—	—
2375	1946	9.1	2057	9.6	—	—	—	—	—	—
2500	2038	9.5	2142	10.0	—	—	—	—	—	—

CFM	AVAILABLE EXTERNAL STATIC PRESSURE (in. wg)									
	1.2		1.4		1.6		1.8		2.0	
	RPM	Vdc	RPM	Vdc	RPM	Vdc	RPM	Vdc	RPM	Vdc
1500	2036	9.5	2144	10.0	—	—	—	—	—	—
1625	2095	9.7	—	—	—	—	—	—	—	—
1750	—	—	—	—	—	—	—	—	—	—
1875	—	—	—	—	—	—	—	—	—	—
2000	—	—	—	—	—	—	—	—	—	—
2125	—	—	—	—	—	—	—	—	—	—
2250	—	—	—	—	—	—	—	—	—	—
2375	—	—	—	—	—	—	—	—	—	—
2500	—	—	—	—	—	—	—	—	—	—

- Standard Static 1335-2150 RPM

NOTE: Fan tables include highest gas heat. Utilize static pressure gain tables for lower gas heat capacities.

48GC**06 THREE PHASE - MEDIUM STATIC — 5 TON HORIZONTAL SUPPLY (RPM - VDC)

CFM	AVAILABLE EXTERNAL STATIC PRESSURE (in. wg)									
	0.2		0.4		0.6		0.8		1.0	
	RPM	Vdc	RPM	Vdc	RPM	Vdc	RPM	Vdc	RPM	Vdc
1500	1335	5.6	1507	6.3	1660	6.9	1796	7.5	1921	8.0
1625	1418	5.9	1579	6.6	1727	7.2	1860	7.8	1982	8.3
1750	1502	6.3	1654	6.9	1797	7.5	1927	8.1	2046	8.6
1875	1589	6.6	1731	7.2	1867	7.8	1994	8.3	2111	8.8
2000	1676	7.0	1810	7.6	1940	8.1	2063	8.6	2177	9.1
2125	1765	7.4	1890	7.9	2015	8.4	2133	8.9	2245	9.4
2250	1855	7.8	1973	8.3	2091	8.7	2206	9.2	2314	9.7
2375	1946	8.1	2057	8.6	2169	9.1	2279	9.5	2385	10.0
2500	2038	8.5	2142	9.0	2249	9.4	2355	9.9	—	—

CFM	AVAILABLE EXTERNAL STATIC PRESSURE (in. wg)									
	1.2		1.4		1.6		1.8		2.0	
	RPM	Vdc	RPM	Vdc	RPM	Vdc	RPM	Vdc	RPM	Vdc
1500	2036	8.5	2144	9.0	2245	9.4	2342	9.8	—	—
1625	2095	8.8	2201	9.2	2301	9.6	—	—	—	—
1750	2157	9.0	2261	9.5	2359	9.9	—	—	—	—
1875	2219	9.3	2322	9.7	—	—	—	—	—	—
2000	2284	9.6	2384	10.0	—	—	—	—	—	—
2125	2350	9.8	—	—	—	—	—	—	—	—
2250	—	—	—	—	—	—	—	—	—	—
2375	—	—	—	—	—	—	—	—	—	—
2500	—	—	—	—	—	—	—	—	—	—

Medium Static 1335-2390 RPM

NOTE: Fan tables include highest gas heat. Utilize static pressure gain tables for lower gas heat capacities.

48GC**06 THREE PHASE - HIGH STATIC — 5 TON HORIZONTAL SUPPLY (RPM - VDC)

CFM	AVAILABLE EXTERNAL STATIC PRESSURE (in. wg)									
	0.2		0.4		0.6		0.8		1.0	
	RPM	Vdc	RPM	Vdc	RPM	Vdc	RPM	Vdc	RPM	Vdc
1500	1335	4.7	1507	5.3	1660	5.9	1796	6.3	1921	6.8
1625	1418	5.0	1579	5.6	1727	6.1	1860	6.6	1982	7.0
1750	1502	5.3	1654	5.8	1797	6.3	1927	6.8	2046	7.2
1875	1589	5.6	1731	6.1	1867	6.6	1994	7.0	2111	7.4
2000	1676	5.9	1810	6.4	1940	6.8	2063	7.3	2177	7.7
2125	1765	6.2	1890	6.7	2015	7.1	2133	7.5	2245	7.9
2250	1855	6.5	1973	7.0	2091	7.4	2206	7.8	2314	8.2
2375	1946	6.9	2057	7.3	2169	7.6	2279	8.0	2385	8.4
2500	2038	7.2	2142	7.6	2249	7.9	2355	8.3	2457	8.7

CFM	AVAILABLE EXTERNAL STATIC PRESSURE (in. wg)									
	1.2		1.4		1.6		1.8		2.0	
	RPM	Vdc	RPM	Vdc	RPM	Vdc	RPM	Vdc	RPM	Vdc
1500	2036	7.2	2144	7.6	2245	7.9	2342	8.3	2435	8.6
1625	2095	7.4	2201	7.8	2301	8.1	2396	8.4	2487	8.8
1750	2157	7.6	2261	8.0	2359	8.3	2453	8.6	2543	9.0
1875	2219	7.8	2322	8.2	2419	8.5	2511	8.9	2599	9.2
2000	2284	8.1	2384	8.4	2480	8.7	2571	9.1	2658	9.4
2125	2350	8.3	2449	8.6	2542	9.0	2632	9.3	2718	9.6
2250	2417	8.5	2514	8.9	2607	9.2	2695	9.5	2779	9.8
2375	2485	8.8	2581	9.1	2672	9.4	2759	9.7	—	—
2500	2555	9.0	2648	9.3	2738	9.7	2824	10.0	—	—

High Static 1335-2836 RPM

NOTE: Fan tables include highest gas heat. Utilize static pressure gain tables for lower gas heat capacities.

50GC**04 SINGLE PHASE — 3 TON VERTICAL SUPPLY (RPM - BHP)

CFM	AVAILABLE EXTERNAL STATIC PRESSURE (in. wg)									
	0.2		0.4		0.6		0.8		1.0	
	RPM	BHP	RPM	BHP	RPM	BHP	RPM	BHP	RPM	BHP
900	1060	0.08	1325	0.16	1541	0.25	1718	0.35	1870	0.46
975	1103	0.09	1356	0.17	1572	0.27	1752	0.37	1906	0.48
1050	1149	0.11	1388	0.19	1602	0.29	1784	0.40	1941	0.51
1125	1198	0.12	1423	0.20	1632	0.30	1815	0.42	1973	0.53
1200	1249	0.14	1460	0.22	1663	0.32	1845	0.44	2005	0.56
1275	1302	0.15	1500	0.24	1694	0.34	1875	0.46	2036	0.59
1350	1356	0.17	1542	0.26	1728	0.36	1905	0.48	2066	0.61
1425	1412	0.20	1587	0.28	1764	0.38	1936	0.51	2096	0.64
1500	1469	0.22	1634	0.30	1803	0.41	1968	0.53	2126	0.67

CFM	AVAILABLE EXTERNAL STATIC PRESSURE (in. wg)									
	1.2		1.4		1.6		1.8		2.0	
	RPM	BHP	RPM	BHP	RPM	BHP	RPM	BHP	RPM	BHP
900	2006	0.56	2130	0.67	2244	0.79	2352	0.91	2453	1.03
975	2044	0.59	2168	0.71	2283	0.83	2391	0.95	—	—
1050	2080	0.63	2206	0.75	2322	0.87	2430	1.00	—	—
1125	2115	0.66	2242	0.78	2359	0.91	2468	1.05	—	—
1200	2148	0.69	2277	0.82	2396	0.96	—	—	—	—
1275	2180	0.72	2311	0.86	2431	1.00	—	—	—	—
1350	2211	0.75	2343	0.90	2465	1.04	—	—	—	—
1425	2241	0.78	2375	0.93	—	—	—	—	—	—
1500	2271	0.82	2405	0.97	—	—	—	—	—	—

Standard Static 1060-1890 RPM, 0.44 Max BHP

Medium Static 1060-2190 RPM, 0.71 Max BHP

High Static 1060-2490 RPM, 1.07 Max BHP

50GC**04 SINGLE PHASE - STANDARD STATIC — 3 TON VERTICAL SUPPLY (RPM - VDC)

CFM	AVAILABLE EXTERNAL STATIC PRESSURE (in. wg)									
	0.2		0.4		0.6		0.8		1.0	
	RPM	Vdc	RPM	Vdc	RPM	Vdc	RPM	Vdc	RPM	Vdc
900	1060	5.6	1325	7.0	1541	8.2	1718	9.1	—	—
975	1103	5.8	1356	7.2	1572	8.3	1752	9.3	—	—
1050	1149	6.1	1388	7.3	1602	8.5	1784	9.4	—	—
1125	1198	6.3	1423	7.5	1632	8.6	1815	9.6	—	—
1200	1249	6.6	1460	7.7	1663	8.8	1845	9.8	—	—
1275	1302	6.9	1500	7.9	1694	9.0	—	—	—	—
1350	1356	7.2	1542	8.2	1728	9.1	—	—	—	—
1425	1412	7.5	1587	8.4	1764	9.3	—	—	—	—
1500	1469	7.8	1634	8.6	1803	9.5	—	—	—	—

CFM	AVAILABLE EXTERNAL STATIC PRESSURE (in. wg)									
	1.2		1.4		1.6		1.8		2.0	
	RPM	Vdc	RPM	Vdc	RPM	Vdc	RPM	Vdc	RPM	Vdc
900	—	—	—	—	—	—	—	—	—	—
975	—	—	—	—	—	—	—	—	—	—
1050	—	—	—	—	—	—	—	—	—	—
1125	—	—	—	—	—	—	—	—	—	—
1200	—	—	—	—	—	—	—	—	—	—
1275	—	—	—	—	—	—	—	—	—	—
1350	—	—	—	—	—	—	—	—	—	—
1425	—	—	—	—	—	—	—	—	—	—
1500	—	—	—	—	—	—	—	—	—	—

Standard Static 1060-1890 RPM

50GC**04 SINGLE PHASE - MEDIUM STATIC — 3 TON VERTICAL SUPPLY (RPM - VDC)

CFM	AVAILABLE EXTERNAL STATIC PRESSURE (in. wg)									
	0.2		0.4		0.6		0.8		1.0	
	RPM	Vdc	RPM	Vdc	RPM	Vdc	RPM	Vdc	RPM	Vdc
900	1060	4.8	1325	6.1	1541	7.0	1718	7.8	1870	8.5
975	1103	5.0	1356	6.2	1572	7.2	1752	8.0	1906	8.7
1050	1149	5.2	1388	6.3	1602	7.3	1784	8.1	1941	8.9
1125	1198	5.5	1423	6.5	1632	7.5	1815	8.3	1973	9.0
1200	1249	5.7	1460	6.7	1663	7.6	1845	8.4	2005	9.2
1275	1302	5.9	1500	6.8	1694	7.7	1875	8.6	2036	9.3
1350	1356	6.2	1542	7.0	1728	7.9	1905	8.7	2066	9.4
1425	1412	6.4	1587	7.2	1764	8.1	1936	8.8	2096	9.6
1500	1469	6.7	1634	7.5	1803	8.2	1968	9.0	2126	9.7

CFM	AVAILABLE EXTERNAL STATIC PRESSURE (in. wg)									
	1.2		1.4		1.6		1.8		2.0	
	RPM	Vdc	RPM	Vdc	RPM	Vdc	RPM	Vdc	RPM	Vdc
900	2006	9.2	2130	9.7	—	—	—	—	—	—
975	2044	9.3	2168	9.9	—	—	—	—	—	—
1050	2080	9.5	—	—	—	—	—	—	—	—
1125	2115	9.7	—	—	—	—	—	—	—	—
1200	2148	9.8	—	—	—	—	—	—	—	—
1275	2180	10.0	—	—	—	—	—	—	—	—
1350	—	—	—	—	—	—	—	—	—	—
1425	—	—	—	—	—	—	—	—	—	—
1500	—	—	—	—	—	—	—	—	—	—

Medium Static 1060-2190 RPM

50GC**04 SINGLE PHASE - HIGH STATIC — 3 TON VERTICAL SUPPLY (RPM - VDC)

CFM	AVAILABLE EXTERNAL STATIC PRESSURE (in. wg)									
	0.2		0.4		0.6		0.8		1.0	
	RPM	Vdc	RPM	Vdc	RPM	Vdc	RPM	Vdc	RPM	Vdc
900	1060	4.3	1325	5.3	1541	6.2	1718	6.9	1870	7.5
975	1103	4.4	1356	5.4	1572	6.3	1752	7.0	1906	7.7
1050	1149	4.6	1388	5.6	1602	6.4	1784	7.2	1941	7.8
1125	1198	4.8	1423	5.7	1632	6.6	1815	7.3	1973	7.9
1200	1249	5.0	1460	5.9	1663	6.7	1845	7.4	2005	8.1
1275	1302	5.2	1500	6.0	1694	6.8	1875	7.5	2036	8.2
1350	1356	5.4	1542	6.2	1728	6.9	1905	7.7	2066	8.3
1425	1412	5.7	1587	6.4	1764	7.1	1936	7.8	2096	8.4
1500	1469	5.9	1634	6.6	1803	7.2	1968	7.9	2126	8.5

CFM	AVAILABLE EXTERNAL STATIC PRESSURE (in. wg)									
	1.2		1.4		1.6		1.8		2.0	
	RPM	Vdc	RPM	Vdc	RPM	Vdc	RPM	Vdc	RPM	Vdc
900	2006	8.1	2130	8.6	2244	9.0	2352	9.4	2453	9.9
975	2044	8.2	2168	8.7	2283	9.2	2391	9.6	—	—
1050	2080	8.4	2206	8.9	2322	9.3	2430	9.8	—	—
1125	2115	8.5	2242	9.0	2359	9.5	2468	9.9	—	—
1200	2148	8.6	2277	9.1	2396	9.6	—	—	—	—
1275	2180	8.8	2311	9.3	2431	9.8	—	—	—	—
1350	2211	8.9	2343	9.4	2465	9.9	—	—	—	—
1425	2241	9.0	2375	9.5	—	—	—	—	—	—
1500	2271	9.1	2405	9.7	—	—	—	—	—	—

High Static 1060-2490 RPM

50GC**04 THREE PHASE — 3 TON VERTICAL SUPPLY (RPM - BHP)

CFM	AVAILABLE EXTERNAL STATIC PRESSURE (in. wg)									
	0.2		0.4		0.6		0.8		1.0	
	RPM	BHP	RPM	BHP	RPM	BHP	RPM	BHP	RPM	BHP
900	1060	0.08	1325	0.16	1541	0.25	1718	0.35	1870	0.46
975	1103	0.09	1356	0.17	1572	0.27	1752	0.37	1906	0.48
1050	1149	0.11	1388	0.19	1602	0.29	1784	0.40	1941	0.51
1125	1198	0.12	1423	0.20	1632	0.30	1815	0.42	1973	0.53
1200	1249	0.14	1460	0.22	1663	0.32	1845	0.44	2005	0.56
1275	1302	0.15	1500	0.24	1694	0.34	1875	0.46	2036	0.59
1350	1356	0.17	1542	0.26	1728	0.36	1905	0.48	2066	0.61
1425	1412	0.20	1587	0.28	1764	0.38	1936	0.51	2096	0.64
1500	1469	0.22	1634	0.30	1803	0.41	1968	0.53	2126	0.67

CFM	AVAILABLE EXTERNAL STATIC PRESSURE (in. wg)									
	1.2		1.4		1.6		1.8		2.0	
	RPM	BHP	RPM	BHP	RPM	BHP	RPM	BHP	RPM	BHP
900	2006	0.56	2130	0.67	2244	0.79	2352	0.91	2453	1.03
975	2044	0.59	2168	0.71	2283	0.83	2391	0.95	—	—
1050	2080	0.63	2206	0.75	2322	0.87	2430	1.00	—	—
1125	2115	0.66	2242	0.78	2359	0.91	2468	1.05	—	—
1200	2148	0.69	2277	0.82	2396	0.96	—	—	—	—
1275	2180	0.72	2311	0.86	2431	1.00	—	—	—	—
1350	2211	0.75	2343	0.90	2465	1.04	—	—	—	—
1425	2241	0.78	2375	0.93	—	—	—	—	—	—
1500	2271	0.82	2405	0.97	—	—	—	—	—	—

Standard Static 1060-1890 RPM, 0.44 Max BHP

Medium Static 1060-2190 RPM, 0.71 Max BHP

High Static 1060-2490 RPM, 1.07 Max BHP

50GC**04 THREE PHASE - STANDARD STATIC — 3 TON VERTICAL SUPPLY (RPM - VDC)

CFM	AVAILABLE EXTERNAL STATIC PRESSURE (in. wg)									
	0.2		0.4		0.6		0.8		1.0	
	RPM	Vdc	RPM	Vdc	RPM	Vdc	RPM	Vdc	RPM	Vdc
900	1060	5.6	1325	7.0	1541	8.2	1718	9.1	—	—
975	1103	5.8	1356	7.2	1572	8.3	1752	9.3	—	—
1050	1149	6.1	1388	7.3	1602	8.5	1784	9.4	—	—
1125	1198	6.3	1423	7.5	1632	8.6	1815	9.6	—	—
1200	1249	6.6	1460	7.7	1663	8.8	1845	9.8	—	—
1275	1302	6.9	1500	7.9	1694	9.0	—	—	—	—
1350	1356	7.2	1542	8.2	1728	9.1	—	—	—	—
1425	1412	7.5	1587	8.4	1764	9.3	—	—	—	—
1500	1469	7.8	1634	8.6	1803	9.5	—	—	—	—

CFM	AVAILABLE EXTERNAL STATIC PRESSURE (in. wg)									
	1.2		1.4		1.6		1.8		2.0	
	RPM	Vdc	RPM	Vdc	RPM	Vdc	RPM	Vdc	RPM	Vdc
900	—	—	—	—	—	—	—	—	—	—
975	—	—	—	—	—	—	—	—	—	—
1050	—	—	—	—	—	—	—	—	—	—
1125	—	—	—	—	—	—	—	—	—	—
1200	—	—	—	—	—	—	—	—	—	—
1275	—	—	—	—	—	—	—	—	—	—
1350	—	—	—	—	—	—	—	—	—	—
1425	—	—	—	—	—	—	—	—	—	—
1500	—	—	—	—	—	—	—	—	—	—

Standard Static 1060-1890 RPM

50GC**04 THREE PHASE - MEDIUM STATIC — 3 TON VERTICAL SUPPLY (RPM - VDC)

CFM	AVAILABLE EXTERNAL STATIC PRESSURE (in. wg)									
	0.2		0.4		0.6		0.8		1.0	
	RPM	Vdc	RPM	Vdc	RPM	Vdc	RPM	Vdc	RPM	Vdc
900	1060	4.8	1325	6.1	1541	7.0	1718	7.8	1870	8.5
975	1103	5.0	1356	6.2	1572	7.2	1752	8.0	1906	8.7
1050	1149	5.2	1388	6.3	1602	7.3	1784	8.1	1941	8.9
1125	1198	5.5	1423	6.5	1632	7.5	1815	8.3	1973	9.0
1200	1249	5.7	1460	6.7	1663	7.6	1845	8.4	2005	9.2
1275	1302	5.9	1500	6.8	1694	7.7	1875	8.6	2036	9.3
1350	1356	6.2	1542	7.0	1728	7.9	1905	8.7	2066	9.4
1425	1412	6.4	1587	7.2	1764	8.1	1936	8.8	2096	9.6
1500	1469	6.7	1634	7.5	1803	8.2	1968	9.0	2126	9.7

CFM	AVAILABLE EXTERNAL STATIC PRESSURE (in. wg)									
	1.2		1.4		1.6		1.8		2.0	
	RPM	Vdc	RPM	Vdc	RPM	Vdc	RPM	Vdc	RPM	Vdc
900	2006	9.2	2130	9.7	—	—	—	—	—	—
975	2044	9.3	2168	9.9	—	—	—	—	—	—
1050	2080	9.5	—	—	—	—	—	—	—	—
1125	2115	9.7	—	—	—	—	—	—	—	—
1200	2148	9.8	—	—	—	—	—	—	—	—
1275	2180	10.0	—	—	—	—	—	—	—	—
1350	—	—	—	—	—	—	—	—	—	—
1425	—	—	—	—	—	—	—	—	—	—
1500	—	—	—	—	—	—	—	—	—	—

Medium Static 1060-2190 RPM

50GC**04 THREE PHASE - HIGH STATIC — 3 TON VERTICAL SUPPLY (RPM - VDC)

CFM	AVAILABLE EXTERNAL STATIC PRESSURE (in. wg)									
	0.2		0.4		0.6		0.8		1.0	
	RPM	Vdc	RPM	Vdc	RPM	Vdc	RPM	Vdc	RPM	Vdc
900	1060	4.3	1325	5.3	1541	6.2	1718	6.9	1870	7.5
975	1103	4.4	1356	5.4	1572	6.3	1752	7.0	1906	7.7
1050	1149	4.6	1388	5.6	1602	6.4	1784	7.2	1941	7.8
1125	1198	4.8	1423	5.7	1632	6.6	1815	7.3	1973	7.9
1200	1249	5.0	1460	5.9	1663	6.7	1845	7.4	2005	8.1
1275	1302	5.2	1500	6.0	1694	6.8	1875	7.5	2036	8.2
1350	1356	5.4	1542	6.2	1728	6.9	1905	7.7	2066	8.3
1425	1412	5.7	1587	6.4	1764	7.1	1936	7.8	2096	8.4
1500	1469	5.9	1634	6.6	1803	7.2	1968	7.9	2126	8.5

CFM	AVAILABLE EXTERNAL STATIC PRESSURE (in. wg)									
	1.2		1.4		1.6		1.8		2.0	
	RPM	Vdc	RPM	Vdc	RPM	Vdc	RPM	Vdc	RPM	Vdc
900	2006	8.1	2130	8.6	2244	9.0	2352	9.4	2453	9.9
975	2044	8.2	2168	8.7	2283	9.2	2391	9.6	—	—
1050	2080	8.4	2206	8.9	2322	9.3	2430	9.8	—	—
1125	2115	8.5	2242	9.0	2359	9.5	2468	9.9	—	—
1200	2148	8.6	2277	9.1	2396	9.6	—	—	—	—
1275	2180	8.8	2311	9.3	2431	9.8	—	—	—	—
1350	2211	8.9	2343	9.4	2465	9.9	—	—	—	—
1425	2241	9.0	2375	9.5	—	—	—	—	—	—
1500	2271	9.1	2405	9.7	—	—	—	—	—	—

High Static 1060-2490 RPM

50GC**05 SINGLE PHASE — 4 TON VERTICAL SUPPLY (RPM - BHP)

CFM	AVAILABLE EXTERNAL STATIC PRESSURE (in. wg)									
	0.2		0.4		0.6		0.8		1.0	
	RPM	BHP	RPM	BHP	RPM	BHP	RPM	BHP	RPM	BHP
1200	1121	0.15	1327	0.25	1507	0.37	1667	0.50	1814	0.65
1300	1179	0.18	1375	0.28	1549	0.40	1705	0.54	1849	0.69
1400	1239	0.21	1425	0.31	1593	0.44	1746	0.58	1886	0.73
1500	1301	0.24	1477	0.35	1639	0.47	1788	0.62	1925	0.77
1600	1365	0.27	1531	0.39	1688	0.52	1832	0.66	1966	0.82
1700	1430	0.31	1587	0.43	1738	0.56	1878	0.71	2009	0.87
1800	1496	0.36	1644	0.48	1789	0.61	1926	0.76	2053	0.93
1900	1565	0.41	1703	0.53	1842	0.67	1975	0.82	2099	0.99
2000	1633	0.46	1764	0.59	1897	0.73	2025	0.89	2147	1.06

CFM	AVAILABLE EXTERNAL STATIC PRESSURE (in. wg)									
	1.2		1.4		1.6		1.8		2.0	
	RPM	BHP	RPM	BHP	RPM	BHP	RPM	BHP	RPM	BHP
1200	1950	0.81	2077	0.97	2195	1.15	2306	1.33	2411	1.52
1300	1983	0.85	2108	1.02	2226	1.20	2337	1.38	—	—
1400	2017	0.89	2140	1.06	2257	1.24	2367	1.43	—	—
1500	2053	0.93	2174	1.11	2289	1.29	2398	1.49	—	—
1600	2092	0.98	2210	1.16	2323	1.35	—	—	—	—
1700	2132	1.04	2248	1.22	2359	1.41	—	—	—	—
1800	2174	1.10	2288	1.28	2397	1.47	—	—	—	—
1900	2217	1.16	2329	1.35	—	—	—	—	—	—
2000	2262	1.23	2372	1.42	—	—	—	—	—	—

Standard Static 1121-1900 RPM, 0.72 Max BHP

Medium Static 1121-2170 RPM, 1.06 Max BHP

High Static 1121-2460 RPM, 1.53 Max BHP

50GC**05 SINGLE PHASE - STANDARD STATIC — 4 TON VERTICAL SUPPLY (RPM - VDC)

CFM	AVAILABLE EXTERNAL STATIC PRESSURE (in. wg)									
	0.2		0.4		0.6		0.8		1.0	
	RPM	Vdc	RPM	Vdc	RPM	Vdc	RPM	Vdc	RPM	Vdc
1200	1121	5.9	1327	7.0	1507	7.9	1667	8.8	1814	9.5
1300	1179	6.2	1375	7.2	1549	8.2	1705	9.0	1849	9.7
1400	1239	6.5	1425	7.5	1593	8.4	1746	9.2	1886	9.9
1500	1301	6.8	1477	7.8	1639	8.6	1788	9.4	—	—
1600	1365	7.2	1531	8.1	1688	8.9	1832	9.6	—	—
1700	1430	7.5	1587	8.4	1738	9.1	1878	9.9	—	—
1800	1496	7.9	1644	8.7	1789	9.4	—	—	—	—
1900	1565	8.2	1703	9.0	1842	9.7	—	—	—	—
2000	1633	8.6	1764	9.3	1897	10.0	—	—	—	—

CFM	AVAILABLE EXTERNAL STATIC PRESSURE (in. wg)									
	1.2		1.4		1.6		1.8		2.0	
	RPM	Vdc	RPM	Vdc	RPM	Vdc	RPM	Vdc	RPM	Vdc
1200	—	—	—	—	—	—	—	—	—	—
1300	—	—	—	—	—	—	—	—	—	—
1400	—	—	—	—	—	—	—	—	—	—
1500	—	—	—	—	—	—	—	—	—	—
1600	—	—	—	—	—	—	—	—	—	—
1700	—	—	—	—	—	—	—	—	—	—
1800	—	—	—	—	—	—	—	—	—	—
1900	—	—	—	—	—	—	—	—	—	—
2000	—	—	—	—	—	—	—	—	—	—

Standard Static 1121-1900 RPM

50GC**05 SINGLE PHASE - MEDIUM STATIC — 4 TON VERTICAL SUPPLY (RPM - VDC)

CFM	AVAILABLE EXTERNAL STATIC PRESSURE (in. wg)									
	0.2		0.4		0.6		0.8		1.0	
	RPM	Vdc	RPM	Vdc	RPM	Vdc	RPM	Vdc	RPM	Vdc
1200	1121	5.2	1327	6.1	1507	6.9	1667	7.7	1814	8.4
1300	1179	5.4	1375	6.3	1549	7.1	1705	7.9	1849	8.5
1400	1239	5.7	1425	6.6	1593	7.3	1746	8.0	1886	8.7
1500	1301	6.0	1477	6.8	1639	7.6	1788	8.2	1925	8.9
1600	1365	6.3	1531	7.1	1688	7.8	1832	8.4	1966	9.1
1700	1430	6.6	1587	7.3	1738	8.0	1878	8.7	2009	9.3
1800	1496	6.9	1644	7.6	1789	8.2	1926	8.9	2053	9.5
1900	1565	7.2	1703	7.8	1842	8.5	1975	9.1	2099	9.7
2000	1633	7.5	1764	8.1	1897	8.7	2025	9.3	2147	9.9

CFM	AVAILABLE EXTERNAL STATIC PRESSURE (in. wg)									
	1.2		1.4		1.6		1.8		2.0	
	RPM	Vdc	RPM	Vdc	RPM	Vdc	RPM	Vdc	RPM	Vdc
1200	1950	9.0	2077	9.6	—	—	—	—	—	—
1300	1983	9.1	2108	9.7	—	—	—	—	—	—
1400	2017	9.3	2140	9.9	—	—	—	—	—	—
1500	2053	9.5	—	—	—	—	—	—	—	—
1600	2092	9.6	—	—	—	—	—	—	—	—
1700	2132	9.8	—	—	—	—	—	—	—	—
1800	—	—	—	—	—	—	—	—	—	—
1900	—	—	—	—	—	—	—	—	—	—
2000	—	—	—	—	—	—	—	—	—	—

Medium Static 1121-2170 RPM

50GC**05 SINGLE PHASE - HIGH STATIC — 4 TON VERTICAL SUPPLY (RPM - VDC)

CFM	AVAILABLE EXTERNAL STATIC PRESSURE (in. wg)									
	0.2		0.4		0.6		0.8		1.0	
	RPM	Vdc	RPM	Vdc	RPM	Vdc	RPM	Vdc	RPM	Vdc
1200	1121	4.6	1327	5.4	1507	6.1	1667	6.8	1814	7.4
1300	1179	4.8	1375	5.6	1549	6.3	1705	6.9	1849	7.5
1400	1239	5.0	1425	5.8	1593	6.5	1746	7.1	1886	7.7
1500	1301	5.3	1477	6.0	1639	6.7	1788	7.3	1925	7.8
1600	1365	5.5	1531	6.2	1688	6.9	1832	7.4	1966	8.0
1700	1430	5.8	1587	6.5	1738	7.1	1878	7.6	2009	8.2
1800	1496	6.1	1644	6.7	1789	7.3	1926	7.8	2053	8.3
1900	1565	6.4	1703	6.9	1842	7.5	1975	8.0	2099	8.5
2000	1633	6.6	1764	7.2	1897	7.7	2025	8.2	2147	8.7

CFM	AVAILABLE EXTERNAL STATIC PRESSURE (in. wg)									
	1.2		1.4		1.6		1.8		2.0	
	RPM	Vdc	RPM	Vdc	RPM	Vdc	RPM	Vdc	RPM	Vdc
1200	1950	7.9	2077	8.4	2195	8.9	2306	9.4	2411	9.8
1300	1983	8.1	2108	8.6	2226	9.0	2337	9.5	—	—
1400	2017	8.2	2140	8.7	2257	9.2	2367	9.6	—	—
1500	2053	8.3	2174	8.8	2289	9.3	2398	9.7	—	—
1600	2092	8.5	2210	9.0	2323	9.4	—	—	—	—
1700	2132	8.7	2248	9.1	2359	9.6	—	—	—	—
1800	2174	8.8	2288	9.3	2397	9.7	—	—	—	—
1900	2217	9.0	2329	9.5	—	—	—	—	—	—
2000	2262	9.2	2372	9.6	—	—	—	—	—	—

High Static 1121-2460 RPM

50GC**05 THREE PHASE — 4 TON VERTICAL SUPPLY (RPM - BHP)

CFM	AVAILABLE EXTERNAL STATIC PRESSURE (in. wg)									
	0.2		0.4		0.6		0.8		1.0	
	RPM	BHP	RPM	BHP	RPM	BHP	RPM	BHP	RPM	BHP
1200	1120	0.15	1327	0.25	1506	0.37	1667	0.50	1814	0.65
1300	1178	0.18	1375	0.28	1549	0.40	1705	0.54	1849	0.69
1400	1238	0.21	1424	0.31	1593	0.44	1745	0.57	1886	0.73
1500	1300	0.24	1476	0.35	1639	0.47	1788	0.62	1925	0.77
1600	1365	0.27	1530	0.39	1687	0.52	1832	0.66	1966	0.82
1700	1430	0.31	1586	0.43	1737	0.56	1878	0.71	2009	0.87
1800	1497	0.36	1644	0.48	1789	0.61	1925	0.76	2053	0.93
1900	1565	0.41	1703	0.53	1842	0.67	1974	0.82	2099	0.99
2000	1633	0.46	1764	0.59	1897	0.73	2025	0.89	2146	1.05

CFM	AVAILABLE EXTERNAL STATIC PRESSURE (in. wg)									
	1.2		1.4		1.6		1.8		2.0	
	RPM	BHP	RPM	BHP	RPM	BHP	RPM	BHP	RPM	BHP
1200	1950	0.81	2077	0.97	2195	1.15	2306	1.33	2411	1.52
1300	1983	0.85	2108	1.02	2225	1.19	2336	1.38	2442	1.58
1400	2017	0.89	2140	1.06	2257	1.24	2367	1.43	2472	1.63
1500	2053	0.93	2174	1.11	2289	1.29	2398	1.49	2502	1.69
1600	2091	0.98	2210	1.16	2323	1.35	2431	1.55	2534	1.75
1700	2132	1.04	2248	1.22	2359	1.41	2465	1.61	2567	1.82
1800	2174	1.10	2288	1.28	2397	1.47	2501	1.67	2601	1.88
1900	2217	1.16	2329	1.35	2436	1.54	2539	1.75	2637	1.96
2000	2262	1.23	2372	1.42	2477	1.62	2578	1.83	—	—

Standard Static 1120-1900 RPM, 0.72 Max BHP

Medium Static 1120-2170 RPM, 1.06 Max BHP

High Static 1120-2660 RPM, 1.96 Max BHP

50GC**05 THREE PHASE - STANDARD STATIC — 4 TON VERTICAL SUPPLY (RPM - VDC)

CFM	AVAILABLE EXTERNAL STATIC PRESSURE (in. wg)									
	0.2		0.4		0.6		0.8		1.0	
	RPM	Vdc	RPM	Vdc	RPM	Vdc	RPM	Vdc	RPM	Vdc
1200	1120	5.9	1327	7.0	1506	7.9	1667	8.8	1814	9.5
1300	1178	6.2	1375	7.2	1549	8.2	1705	9.0	1849	9.7
1400	1238	6.5	1424	7.5	1593	8.4	1745	9.2	1886	9.9
1500	1300	6.8	1476	7.8	1639	8.6	1788	9.4	—	—
1600	1365	7.2	1530	8.1	1687	8.9	1832	9.6	—	—
1700	1430	7.5	1586	8.3	1737	9.1	1878	9.9	—	—
1800	1497	7.9	1644	8.7	1789	9.4	—	—	—	—
1900	1565	8.2	1703	9.0	1842	9.7	—	—	—	—
2000	1633	8.6	1764	9.3	1897	10.0	—	—	—	—

CFM	AVAILABLE EXTERNAL STATIC PRESSURE (in. wg)									
	1.2		1.4		1.6		1.8		2.0	
	RPM	Vdc	RPM	Vdc	RPM	Vdc	RPM	Vdc	RPM	Vdc
1200	—	—	—	—	—	—	—	—	—	—
1300	—	—	—	—	—	—	—	—	—	—
1400	—	—	—	—	—	—	—	—	—	—
1500	—	—	—	—	—	—	—	—	—	—
1600	—	—	—	—	—	—	—	—	—	—
1700	—	—	—	—	—	—	—	—	—	—
1800	—	—	—	—	—	—	—	—	—	—
1900	—	—	—	—	—	—	—	—	—	—
2000	—	—	—	—	—	—	—	—	—	—

Standard Static 1120-1900 RPM

50GC**05 THREE PHASE - MEDIUM STATIC — 4 TON VERTICAL SUPPLY (RPM - VDC)

CFM	AVAILABLE EXTERNAL STATIC PRESSURE (in. wg)									
	0.2		0.4		0.6		0.8		1.0	
	RPM	Vdc	RPM	Vdc	RPM	Vdc	RPM	Vdc	RPM	Vdc
1200	1120	5.2	1327	6.1	1506	6.9	1667	7.7	1814	8.4
1300	1178	5.4	1375	6.3	1549	7.1	1705	7.9	1849	8.5
1400	1238	5.7	1424	6.6	1593	7.3	1745	8.0	1886	8.7
1500	1300	6.0	1476	6.8	1639	7.6	1788	8.2	1925	8.9
1600	1365	6.3	1530	7.1	1687	7.8	1832	8.4	1966	9.1
1700	1430	6.6	1586	7.3	1737	8.0	1878	8.7	2009	9.3
1800	1497	6.9	1644	7.6	1789	8.2	1925	8.9	2053	9.5
1900	1565	7.2	1703	7.8	1842	8.5	1974	9.1	2099	9.7
2000	1633	7.5	1764	8.1	1897	8.7	2025	9.3	2146	9.9

CFM	AVAILABLE EXTERNAL STATIC PRESSURE (in. wg)									
	1.2		1.4		1.6		1.8		2.0	
	RPM	Vdc	RPM	Vdc	RPM	Vdc	RPM	Vdc	RPM	Vdc
1200	1950	9.0	2077	9.6	—	—	—	—	—	—
1300	1983	9.1	2108	9.7	—	—	—	—	—	—
1400	2017	9.3	2140	9.9	—	—	—	—	—	—
1500	2053	9.5	—	—	—	—	—	—	—	—
1600	2091	9.6	—	—	—	—	—	—	—	—
1700	2132	9.8	—	—	—	—	—	—	—	—
1800	—	—	—	—	—	—	—	—	—	—
1900	—	—	—	—	—	—	—	—	—	—
2000	—	—	—	—	—	—	—	—	—	—

Medium Static 1120-2170 RPM

50GC**05 THREE PHASE - HIGH STATIC — 4 TON VERTICAL SUPPLY (RPM - VDC)

CFM	AVAILABLE EXTERNAL STATIC PRESSURE (in. wg)									
	0.2		0.4		0.6		0.8		1.0	
	RPM	Vdc	RPM	Vdc	RPM	Vdc	RPM	Vdc	RPM	Vdc
1200	1120	4.2	1327	5.0	1506	5.7	1667	6.3	1814	6.8
1300	1178	4.4	1375	5.2	1549	5.8	1705	6.4	1849	7.0
1400	1238	4.7	1424	5.4	1593	6.0	1745	6.6	1886	7.1
1500	1300	4.9	1476	5.5	1639	6.2	1788	6.7	1925	7.2
1600	1365	5.1	1530	5.8	1687	6.3	1832	6.9	1966	7.4
1700	1430	5.4	1586	6.0	1737	6.5	1878	7.1	2009	7.6
1800	1497	5.6	1644	6.2	1789	6.7	1925	7.2	2053	7.7
1900	1565	5.9	1703	6.4	1842	6.9	1974	7.4	2099	7.9
2000	1633	6.1	1764	6.6	1897	7.1	2025	7.6	2146	8.1

CFM	AVAILABLE EXTERNAL STATIC PRESSURE (in. wg)									
	1.2		1.4		1.6		1.8		2.0	
	RPM	Vdc	RPM	Vdc	RPM	Vdc	RPM	Vdc	RPM	Vdc
1200	1950	7.3	2077	7.8	2195	8.3	2306	8.7	2411	9.1
1300	1983	7.5	2108	7.9	2225	8.4	2336	8.8	2442	9.2
1400	2017	7.6	2140	8.0	2257	8.5	2367	8.9	2472	9.3
1500	2053	7.7	2174	8.2	2289	8.6	2398	9.0	2502	9.4
1600	2091	7.9	2210	8.3	2323	8.7	2431	9.1	2534	9.5
1700	2132	8.0	2248	8.5	2359	8.9	2465	9.3	2567	9.7
1800	2174	8.2	2288	8.6	2397	9.0	2501	9.4	2601	9.8
1900	2217	8.3	2329	8.8	2436	9.2	2539	9.5	2637	9.9
2000	2262	8.5	2372	8.9	2477	9.3	2578	9.7	—	—

High Static 1120-2660 RPM

50GC**06 SINGLE PHASE — 5 TON VERTICAL SUPPLY (RPM - BHP)

CFM	AVAILABLE EXTERNAL STATIC PRESSURE (in. wg)									
	0.2		0.4		0.6		0.8		1.0	
	RPM	BHP	RPM	BHP	RPM	BHP	RPM	BHP	RPM	BHP
1500	1228	0.20	1394	0.29	1555	0.40	1701	0.53	1836	0.66
1625	1305	0.24	1457	0.33	1609	0.44	1751	0.57	1882	0.71
1750	1384	0.28	1523	0.37	1666	0.49	1803	0.62	1930	0.76
1875	1466	0.33	1592	0.43	1726	0.54	1857	0.67	1981	0.82
2000	1549	0.39	1664	0.48	1789	0.60	1914	0.74	2034	0.88
2125	1633	0.46	1738	0.55	1855	0.67	1974	0.81	2089	0.95
2250	1718	0.53	1815	0.62	1924	0.74	2036	0.88	2147	1.03
2375	1803	0.61	1894	0.71	1995	0.83	2100	0.97	2206	1.12
2500	1890	0.70	1974	0.80	2068	0.92	2167	1.06	2268	1.21

CFM	AVAILABLE EXTERNAL STATIC PRESSURE (in. wg)									
	1.2		1.4		1.6		1.8		2.0	
	RPM	BHP	RPM	BHP	RPM	BHP	RPM	BHP	RPM	BHP
1500	1961	0.80	2079	0.96	2191	1.12	2297	1.29	—	—
1625	2004	0.85	2120	1.01	2230	1.18	2334	1.35	—	—
1750	2050	0.91	2163	1.07	2270	1.24	2373	1.41	—	—
1875	2098	0.97	2208	1.13	2314	1.31	—	—	—	—
2000	2148	1.04	2256	1.21	2359	1.38	—	—	—	—
2125	2200	1.11	2306	1.28	—	—	—	—	—	—
2250	2254	1.20	2357	1.37	—	—	—	—	—	—
2375	2310	1.28	—	—	—	—	—	—	—	—
2500	2368	1.38	—	—	—	—	—	—	—	—

Standard Static 1228-2150 RPM, 1.06 Max BHP

Medium Static 1228-2390 RPM, 1.44 Max BHP

50GC**06 SINGLE PHASE - STANDARD STATIC — 5 TON VERTICAL SUPPLY (RPM - VDC)

CFM	AVAILABLE EXTERNAL STATIC PRESSURE (in. wg)									
	0.2		0.4		0.6		0.8		1.0	
	RPM	Vdc	RPM	Vdc	RPM	Vdc	RPM	Vdc	RPM	Vdc
1500	1228	5.7	1394	6.5	1555	7.2	1701	7.9	1836	8.5
1625	1305	6.1	1457	6.8	1609	7.5	1751	8.1	1882	8.8
1750	1384	6.4	1523	7.1	1666	7.7	1803	8.4	1930	9.0
1875	1466	6.8	1592	7.4	1726	8.0	1857	8.6	1981	9.2
2000	1549	7.2	1664	7.7	1789	8.3	1914	8.9	2034	9.5
2125	1633	7.6	1738	8.1	1855	8.6	1974	9.2	2089	9.7
2250	1718	8.0	1815	8.4	1924	8.9	2036	9.5	2147	10.0
2375	1803	8.4	1894	8.8	1995	9.3	2100	9.8	—	—
2500	1890	8.8	1974	9.2	2068	9.6	—	—	—	—

CFM	AVAILABLE EXTERNAL STATIC PRESSURE (in. wg)									
	1.2		1.4		1.6		1.8		2.0	
	RPM	Vdc	RPM	Vdc	RPM	Vdc	RPM	Vdc	RPM	Vdc
1500	1961	9.1	2079	9.7	—	—	—	—	—	—
1625	2004	9.3	2120	9.9	—	—	—	—	—	—
1750	2050	9.5	—	—	—	—	—	—	—	—
1875	2098	9.8	—	—	—	—	—	—	—	—
2000	2148	10.0	—	—	—	—	—	—	—	—
2125	—	—	—	—	—	—	—	—	—	—
2250	—	—	—	—	—	—	—	—	—	—
2375	—	—	—	—	—	—	—	—	—	—
2500	—	—	—	—	—	—	—	—	—	—

Standard Static 1228-2150 RPM

50GC**06 SINGLE PHASE - MEDIUM STATIC — 3 TON VERTICAL SUPPLY (RPM - VDC)

CFM	AVAILABLE EXTERNAL STATIC PRESSURE (in. wg)									
	0.2		0.4		0.6		0.8		1.0	
	RPM	Vdc	RPM	Vdc	RPM	Vdc	RPM	Vdc	RPM	Vdc
1500	1228	5.1	1394	5.8	1555	6.5	1701	7.1	1836	7.7
1625	1305	5.5	1457	6.1	1609	6.7	1751	7.3	1882	7.9
1750	1384	5.8	1523	6.4	1666	7.0	1803	7.5	1930	8.1
1875	1466	6.1	1592	6.7	1726	7.2	1857	7.8	1981	8.3
2000	1549	6.5	1664	7.0	1789	7.5	1914	8.0	2034	8.5
2125	1633	6.8	1738	7.3	1855	7.8	1974	8.3	2089	8.7
2250	1718	7.2	1815	7.6	1924	8.1	2036	8.5	2147	9.0
2375	1803	7.5	1894	7.9	1995	8.3	2100	8.8	2206	9.2
2500	1890	7.9	1974	8.3	2068	8.7	2167	9.1	2268	9.5

CFM	AVAILABLE EXTERNAL STATIC PRESSURE (in. wg)									
	1.2		1.4		1.6		1.8		2.0	
	RPM	Vdc	RPM	Vdc	RPM	Vdc	RPM	Vdc	RPM	Vdc
1500	1961	8.2	2079	8.7	2191	9.2	2297	9.6	—	—
1625	2004	8.4	2120	8.9	2230	9.3	2334	9.8	—	—
1750	2050	8.6	2163	9.1	2270	9.5	2373	9.9	—	—
1875	2098	8.8	2208	9.2	2314	9.7	—	—	—	—
2000	2148	9.0	2256	9.4	2359	9.9	—	—	—	—
2125	2200	9.2	2306	9.6	—	—	—	—	—	—
2250	2254	9.4	2357	9.9	—	—	—	—	—	—
2375	2310	9.7	—	—	—	—	—	—	—	—
2500	2368	9.9	—	—	—	—	—	—	—	—

Medium Static 1228-2390 RPM

50GC**06 THREE PHASE — 5 TON VERTICAL SUPPLY (RPM - BHP)

CFM	AVAILABLE EXTERNAL STATIC PRESSURE (in. wg)									
	0.2		0.4		0.6		0.8		1.0	
	RPM	BHP	RPM	BHP	RPM	BHP	RPM	BHP	RPM	BHP
1500	1228	0.20	1394	0.29	1555	0.40	1701	0.53	1836	0.66
1625	1305	0.24	1457	0.33	1609	0.44	1751	0.57	1882	0.71
1750	1384	0.28	1523	0.37	1666	0.49	1803	0.62	1930	0.76
1875	1466	0.33	1592	0.43	1726	0.54	1857	0.67	1981	0.82
2000	1549	0.39	1664	0.48	1789	0.60	1914	0.74	2034	0.88
2125	1633	0.46	1738	0.55	1855	0.67	1974	0.81	2089	0.95
2250	1718	0.53	1815	0.62	1924	0.74	2036	0.88	2147	1.03
2375	1803	0.61	1894	0.71	1995	0.83	2100	0.97	2206	1.12
2500	1890	0.70	1974	0.80	2068	0.92	2167	1.06	2268	1.21

CFM	AVAILABLE EXTERNAL STATIC PRESSURE (in. wg)									
	1.2		1.4		1.6		1.8		2.0	
	RPM	BHP	RPM	BHP	RPM	BHP	RPM	BHP	RPM	BHP
1500	1961	0.80	2079	0.96	2191	1.12	2297	1.29	2399	1.47
1625	2004	0.85	2120	1.01	2230	1.18	2334	1.35	2434	1.53
1750	2050	0.91	2163	1.07	2270	1.24	2373	1.41	2472	1.60
1875	2098	0.97	2208	1.13	2314	1.31	2415	1.48	2511	1.67
2000	2148	1.04	2256	1.21	2359	1.38	2458	1.56	2553	1.75
2125	2200	1.11	2306	1.28	2407	1.46	2504	1.64	2597	1.83
2250	2254	1.20	2357	1.37	2456	1.55	2551	1.73	2643	1.93
2375	2310	1.28	2411	1.46	2507	1.64	2601	1.83	2691	2.03
2500	2368	1.38	2465	1.56	2560	1.75	2651	1.94	2740	2.14

Standard Static 1228-2150 RPM, 1.06 Max BHP

Medium Static 1228-2390 RPM, 1.44 Max BHP

High Static 1228-2836 RPM, 2.43 Max BHP

50GC**06 THREE PHASE - STANDARD STATIC — 5 TON VERTICAL SUPPLY (RPM - Vdc)

CFM	AVAILABLE EXTERNAL STATIC PRESSURE (in. wg)									
	0.2		0.4		0.6		0.8		1.0	
	RPM	Vdc	RPM	Vdc	RPM	Vdc	RPM	Vdc	RPM	Vdc
1500	1228	5.7	1394	6.5	1555	7.2	1701	7.9	1836	8.5
1625	1305	6.1	1457	6.8	1609	7.5	1751	8.1	1882	8.8
1750	1384	6.4	1523	7.1	1666	7.7	1803	8.4	1930	9.0
1875	1466	6.8	1592	7.4	1726	8.0	1857	8.6	1981	9.2
2000	1549	7.2	1664	7.7	1789	8.3	1914	8.9	2034	9.5
2125	1633	7.6	1738	8.1	1855	8.6	1974	9.2	2089	9.7
2250	1718	8.0	1815	8.4	1924	8.9	2036	9.5	2147	10.0
2375	1803	8.4	1894	8.8	1995	9.3	2100	9.8	—	—
2500	1890	8.8	1974	9.2	2068	9.6	—	—	—	—

CFM	AVAILABLE EXTERNAL STATIC PRESSURE (in. wg)									
	1.2		1.4		1.6		1.8		2.0	
	RPM	Vdc	RPM	Vdc	RPM	Vdc	RPM	Vdc	RPM	Vdc
1500	1961	9.1	2079	9.7	—	—	—	—	—	—
1625	2004	9.3	2120	9.9	—	—	—	—	—	—
1750	2050	9.5	—	—	—	—	—	—	—	—
1875	2098	9.8	—	—	—	—	—	—	—	—
2000	2148	10.0	—	—	—	—	—	—	—	—
2125	—	—	—	—	—	—	—	—	—	—
2250	—	—	—	—	—	—	—	—	—	—
2375	—	—	—	—	—	—	—	—	—	—
2500	—	—	—	—	—	—	—	—	—	—

Standard Static 1228-2150 RPM

50GC**06 THREE PHASE - MEDIUM STATIC — 5 TON VERTICAL SUPPLY (RPM - VDC)

CFM	AVAILABLE EXTERNAL STATIC PRESSURE (in. wg)									
	0.2		0.4		0.6		0.8		1.0	
	RPM	Vdc	RPM	Vdc	RPM	Vdc	RPM	Vdc	RPM	Vdc
1500	1228	5.1	1394	5.8	1555	6.5	1701	7.1	1836	7.7
1625	1305	5.5	1457	6.1	1609	6.7	1751	7.3	1882	7.9
1750	1384	5.8	1523	6.4	1666	7.0	1803	7.5	1930	8.1
1875	1466	6.1	1592	6.7	1726	7.2	1857	7.8	1981	8.3
2000	1549	6.5	1664	7.0	1789	7.5	1914	8.0	2034	8.5
2125	1633	6.8	1738	7.3	1855	7.8	1974	8.3	2089	8.7
2250	1718	7.2	1815	7.6	1924	8.1	2036	8.5	2147	9.0
2375	1803	7.5	1894	7.9	1995	8.3	2100	8.8	2206	9.2
2500	1890	7.9	1974	8.3	2068	8.7	2167	9.1	2268	9.5

CFM	AVAILABLE EXTERNAL STATIC PRESSURE (in. wg)									
	1.2		1.4		1.6		1.8		2.0	
	RPM	Vdc	RPM	Vdc	RPM	Vdc	RPM	Vdc	RPM	Vdc
1500	1961	8.2	2079	8.7	2191	9.2	2297	9.6	—	—
1625	2004	8.4	2120	8.9	2230	9.3	2334	9.8	—	—
1750	2050	8.6	2163	9.1	2270	9.5	2373	9.9	—	—
1875	2098	8.8	2208	9.2	2314	9.7	—	—	—	—
2000	2148	9.0	2256	9.4	2359	9.9	—	—	—	—
2125	2200	9.2	2306	9.6	—	—	—	—	—	—
2250	2254	9.4	2357	9.9	—	—	—	—	—	—
2375	2310	9.7	—	—	—	—	—	—	—	—
2500	2368	9.9	—	—	—	—	—	—	—	—

Medium Static 1228-2390 RPM

50GC**06 THREE PHASE - HIGH STATIC — 5 TON VERTICAL SUPPLY (RPM - VDC)

CFM	AVAILABLE EXTERNAL STATIC PRESSURE (in. wg)									
	0.2		0.4		0.6		0.8		1.0	
	RPM	Vdc	RPM	Vdc	RPM	Vdc	RPM	Vdc	RPM	Vdc
1500	1228	4.3	1394	4.9	1555	5.5	1701	6.0	1836	6.5
1625	1305	4.6	1457	5.1	1609	5.7	1751	6.2	1882	6.6
1750	1384	4.9	1523	5.4	1666	5.9	1803	6.4	1930	6.8
1875	1466	5.2	1592	5.6	1726	6.1	1857	6.5	1981	7.0
2000	1549	5.5	1664	5.9	1789	6.3	1914	6.7	2034	7.2
2125	1633	5.8	1738	6.1	1855	6.5	1974	7.0	2089	7.4
2250	1718	6.1	1815	6.4	1924	6.8	2036	7.2	2147	7.6
2375	1803	6.4	1894	6.7	1995	7.0	2100	7.4	2206	7.8
2500	1890	6.7	1974	7.0	2068	7.3	2167	7.6	2268	8.0

CFM	AVAILABLE EXTERNAL STATIC PRESSURE (in. wg)									
	1.2		1.4		1.6		1.8		2.0	
	RPM	Vdc	RPM	Vdc	RPM	Vdc	RPM	Vdc	RPM	Vdc
1500	1961	6.9	2079	7.3	2191	7.7	2297	8.1	2399	8.5
1625	2004	7.1	2120	7.5	2230	7.9	2334	8.2	2434	8.6
1750	2050	7.2	2163	7.6	2270	8.0	2373	8.4	2472	8.7
1875	2098	7.4	2208	7.8	2314	8.2	2415	8.5	2511	8.9
2000	2148	7.6	2256	8.0	2359	8.3	2458	8.7	2553	9.0
2125	2200	7.8	2306	8.1	2407	8.5	2504	8.8	2597	9.2
2250	2254	7.9	2357	8.3	2456	8.7	2551	9.0	2643	9.3
2375	2310	8.1	2411	8.5	2507	8.8	2601	9.2	2691	9.5
2500	2368	8.3	2465	8.7	2560	9.0	2651	9.3	2740	9.7

High Static 1228-2836 RPM

50GC**04 SINGLE PHASE — 3 TON HORIZONTAL SUPPLY (RPM - BHP)

CFM	AVAILABLE EXTERNAL STATIC PRESSURE (in. wg)									
	0.2		0.4		0.6		0.8		1.0	
	RPM	BHP	RPM	BHP	RPM	BHP	RPM	BHP	RPM	BHP
900	1037	0.08	1301	0.15	1517	0.24	1697	0.34	1855	0.44
975	1076	0.09	1331	0.16	1545	0.26	1727	0.36	1885	0.47
1050	1119	0.10	1362	0.18	1573	0.27	1755	0.38	1915	0.49
1125	1164	0.11	1395	0.19	1602	0.29	1783	0.39	1944	0.51
1200	1211	0.12	1429	0.20	1632	0.30	1812	0.41	1972	0.53
1275	1261	0.14	1466	0.22	1663	0.32	1841	0.43	2000	0.56
1350	1313	0.16	1506	0.24	1695	0.34	1870	0.46	2029	0.58
1425	1366	0.18	1548	0.26	1729	0.36	1900	0.48	2058	0.61
1500	1420	0.20	1591	0.28	1765	0.38	1932	0.50	2087	0.63

CFM	AVAILABLE EXTERNAL STATIC PRESSURE (in. wg)									
	1.2		1.4		1.6		1.8		2.0	
	RPM	BHP	RPM	BHP	RPM	BHP	RPM	BHP	RPM	BHP
900	1995	0.55	2123	0.67	2241	0.78	2352	0.91	2455	1.03
975	2027	0.58	2157	0.70	2276	0.82	2387	0.95	—	—
1050	2058	0.61	2189	0.73	2309	0.86	2421	0.99	—	—
1125	2088	0.63	2219	0.76	2341	0.89	2454	1.03	—	—
1200	2117	0.66	2249	0.79	2371	0.93	2485	1.07	—	—
1275	2146	0.69	2278	0.82	2401	0.96	—	—	—	—
1350	2174	0.72	2307	0.86	2431	1.00	—	—	—	—
1425	2202	0.74	2335	0.89	2459	1.04	—	—	—	—
1500	2231	0.77	2364	0.92	2488	1.07	—	—	—	—

Standard Static 1037-1890 RPM, 0.44 Max BHP

Medium Static 1037-2190 RPM, 0.71 Max BHP

High Static 1037-2490 RPM, 1.07 Max BHP

50GC**04 SINGLE PHASE - STANDARD STATIC — 3 TON HORIZONTAL SUPPLY (RPM - VDC)

CFM	AVAILABLE EXTERNAL STATIC PRESSURE (in. wg)									
	0.2		0.4		0.6		0.8		1.0	
	RPM	Vdc	RPM	Vdc	RPM	Vdc	RPM	Vdc	RPM	Vdc
900	1037	5.5	1301	6.9	1517	8.0	1697	9.0	1855	9.8
975	1076	5.7	1331	7.0	1545	8.2	1727	9.1	—	—
1050	1119	5.9	1362	7.2	1573	8.3	1755	9.3	—	—
1125	1164	6.2	1395	7.4	1602	8.5	1783	9.4	—	—
1200	1211	6.4	1429	7.6	1632	8.6	1812	9.6	—	—
1275	1261	6.7	1466	7.8	1663	8.8	1841	9.7	—	—
1350	1313	6.9	1506	8.0	1695	9.0	—	—	—	—
1425	1366	7.2	1548	8.2	1729	9.1	—	—	—	—
1500	1420	7.5	1591	8.4	1765	9.3	—	—	—	—

CFM	AVAILABLE EXTERNAL STATIC PRESSURE (in. wg)									
	1.2		1.4		1.6		1.8		2.0	
	RPM	Vdc	RPM	Vdc	RPM	Vdc	RPM	Vdc	RPM	Vdc
900	—	—	—	—	—	—	—	—	—	—
975	—	—	—	—	—	—	—	—	—	—
1050	—	—	—	—	—	—	—	—	—	—
1125	—	—	—	—	—	—	—	—	—	—
1200	—	—	—	—	—	—	—	—	—	—
1275	—	—	—	—	—	—	—	—	—	—
1350	—	—	—	—	—	—	—	—	—	—
1425	—	—	—	—	—	—	—	—	—	—
1500	—	—	—	—	—	—	—	—	—	—

Standard Static 1037-1890 RPM

50GC**04 SINGLE PHASE - MEDIUM STATIC — 3 TON HORIZONTAL SUPPLY (RPM - VDC)

CFM	AVAILABLE EXTERNAL STATIC PRESSURE (in. wg)									
	0.2		0.4		0.6		0.8		1.0	
	RPM	Vdc	RPM	Vdc	RPM	Vdc	RPM	Vdc	RPM	Vdc
900	1037	4.7	1301	5.9	1517	6.9	1697	7.7	1855	8.5
975	1076	4.9	1331	6.1	1545	7.1	1727	7.9	1885	8.6
1050	1119	5.1	1362	6.2	1573	7.2	1755	8.0	1915	8.7
1125	1164	5.3	1395	6.4	1602	7.3	1783	8.1	1944	8.9
1200	1211	5.5	1429	6.5	1632	7.5	1812	8.3	1972	9.0
1275	1261	5.8	1466	6.7	1663	7.6	1841	8.4	2000	9.1
1350	1313	6.0	1506	6.9	1695	7.7	1870	8.5	2029	9.3
1425	1366	6.2	1548	7.1	1729	7.9	1900	8.7	2058	9.4
1500	1420	6.5	1591	7.3	1765	8.1	1932	8.8	2087	9.5

CFM	AVAILABLE EXTERNAL STATIC PRESSURE (in. wg)									
	1.2		1.4		1.6		1.8		2.0	
	RPM	Vdc	RPM	Vdc	RPM	Vdc	RPM	Vdc	RPM	Vdc
900	1995	9.1	2123	9.7	—	—	—	—	—	—
975	2027	9.3	2157	9.8	—	—	—	—	—	—
1050	2058	9.4	—	—	—	—	—	—	—	—
1125	2088	9.5	—	—	—	—	—	—	—	—
1200	2117	9.7	—	—	—	—	—	—	—	—
1275	2146	9.8	—	—	—	—	—	—	—	—
1350	—	—	—	—	—	—	—	—	—	—
1425	—	—	—	—	—	—	—	—	—	—
1500	—	—	—	—	—	—	—	—	—	—

Medium Static 1037-2190 RPM

50GC**04 SINGLE PHASE - HIGH STATIC — 3 TON HORIZONTAL SUPPLY (RPM - VDC)

CFM	AVAILABLE EXTERNAL STATIC PRESSURE (in. wg)									
	0.2		0.4		0.6		0.8		1.0	
	RPM	Vdc	RPM	Vdc	RPM	Vdc	RPM	Vdc	RPM	Vdc
900	1037	4.2	1301	5.2	1517	6.1	1697	6.8	1855	7.4
975	1076	4.3	1331	5.3	1545	6.2	1727	6.9	1885	7.6
1050	1119	4.5	1362	5.5	1573	6.3	1755	7.0	1915	7.7
1125	1164	4.7	1395	5.6	1602	6.4	1783	7.2	1944	7.8
1200	1211	4.9	1429	5.7	1632	6.6	1812	7.3	1972	7.9
1275	1261	5.1	1466	5.9	1663	6.7	1841	7.4	2000	8.0
1350	1313	5.3	1506	6.0	1695	6.8	1870	7.5	2029	8.1
1425	1366	5.5	1548	6.2	1729	6.9	1900	7.6	2058	8.3
1500	1420	5.7	1591	6.4	1765	7.1	1932	7.8	2087	8.4

CFM	AVAILABLE EXTERNAL STATIC PRESSURE (in. wg)									
	1.2		1.4		1.6		1.8		2.0	
	RPM	Vdc	RPM	Vdc	RPM	Vdc	RPM	Vdc	RPM	Vdc
900	1995	8.0	2123	8.5	2241	9.0	2352	9.4	2455	9.9
975	2027	8.1	2157	8.7	2276	9.1	2387	9.6	—	—
1050	2058	8.3	2189	8.8	2309	9.3	2421	9.7	—	—
1125	2088	8.4	2219	8.9	2341	9.4	2454	9.9	—	—
1200	2117	8.5	2249	9.0	2371	9.5	2485	10.0	—	—
1275	2146	8.6	2278	9.1	2401	9.6	—	—	—	—
1350	2174	8.7	2307	9.3	2431	9.8	—	—	—	—
1425	2202	8.8	2335	9.4	2459	9.9	—	—	—	—
1500	2231	9.0	2364	9.5	2488	10.0	—	—	—	—

High Static 1037-2490 RPM

50GC**04 THREE PHASE — 3 TON HORIZONTAL SUPPLY (RPM - BHP)

CFM	AVAILABLE EXTERNAL STATIC PRESSURE (in. wg)									
	0.2		0.4		0.6		0.8		1.0	
	RPM	BHP	RPM	BHP	RPM	BHP	RPM	BHP	RPM	BHP
900	1037	0.08	1301	0.15	1517	0.24	1697	0.34	1855	0.44
975	1076	0.09	1331	0.16	1545	0.26	1727	0.36	1885	0.47
1050	1119	0.10	1362	0.18	1573	0.27	1755	0.38	1915	0.49
1125	1164	0.11	1395	0.19	1602	0.29	1783	0.39	1944	0.51
1200	1211	0.12	1429	0.20	1632	0.30	1812	0.41	1972	0.53
1275	1261	0.14	1466	0.22	1663	0.32	1841	0.43	2000	0.56
1350	1313	0.16	1506	0.24	1695	0.34	1870	0.46	2029	0.58
1425	1366	0.18	1548	0.26	1729	0.36	1900	0.48	2058	0.61
1500	1420	0.20	1591	0.28	1765	0.38	1932	0.50	2087	0.63

CFM	AVAILABLE EXTERNAL STATIC PRESSURE (in. wg)									
	1.2		1.4		1.6		1.8		2.0	
	RPM	BHP	RPM	BHP	RPM	BHP	RPM	BHP	RPM	BHP
900	1995	0.55	2123	0.67	2241	0.78	2352	0.91	2455	1.03
975	2027	0.58	2157	0.70	2276	0.82	2387	0.95	—	—
1050	2058	0.61	2189	0.73	2309	0.86	2421	0.99	—	—
1125	2088	0.63	2219	0.76	2341	0.89	2454	1.03	—	—
1200	2117	0.66	2249	0.79	2371	0.93	2485	1.07	—	—
1275	2146	0.69	2278	0.82	2401	0.96	—	—	—	—
1350	2174	0.72	2307	0.86	2431	1.00	—	—	—	—
1425	2202	0.74	2335	0.89	2459	1.04	—	—	—	—
1500	2231	0.77	2364	0.92	2488	1.07	—	—	—	—

Standard Static 1037-1890 RPM, 0.44 Max BHP

Medium Static 1037-2190 RPM, 0.71 Max BHP

High Static 1037-2490 RPM, 1.07 Max BHP

50GC**04 THREE PHASE - STANDARD STATIC — 3 TON HORIZONTAL SUPPLY (RPM - VDC)

CFM	AVAILABLE EXTERNAL STATIC PRESSURE (in. wg)									
	0.2		0.4		0.6		0.8		1.0	
	RPM	Vdc	RPM	Vdc	RPM	Vdc	RPM	Vdc	RPM	Vdc
900	1037	5.5	1301	6.9	1517	8.0	1697	9.0	1855	9.8
975	1076	5.7	1331	7.0	1545	8.2	1727	9.1	—	—
1050	1119	5.9	1362	7.2	1573	8.3	1755	9.3	—	—
1125	1164	6.2	1395	7.4	1602	8.5	1783	9.4	—	—
1200	1211	6.4	1429	7.6	1632	8.6	1812	9.6	—	—
1275	1261	6.7	1466	7.8	1663	8.8	1841	9.7	—	—
1350	1313	6.9	1506	8.0	1695	9.0	—	—	—	—
1425	1366	7.2	1548	8.2	1729	9.1	—	—	—	—
1500	1420	7.5	1591	8.4	1765	9.3	—	—	—	—

CFM	AVAILABLE EXTERNAL STATIC PRESSURE (in. wg)									
	1.2		1.4		1.6		1.8		2.0	
	RPM	Vdc	RPM	Vdc	RPM	Vdc	RPM	Vdc	RPM	Vdc
900	—	—	—	—	—	—	—	—	—	—
975	—	—	—	—	—	—	—	—	—	—
1050	—	—	—	—	—	—	—	—	—	—
1125	—	—	—	—	—	—	—	—	—	—
1200	—	—	—	—	—	—	—	—	—	—
1275	—	—	—	—	—	—	—	—	—	—
1350	—	—	—	—	—	—	—	—	—	—
1425	—	—	—	—	—	—	—	—	—	—
1500	—	—	—	—	—	—	—	—	—	—

Standard Static 1037-1890 RPM

50GC**04 THREE PHASE - MEDIUM STATIC — 3 TON HORIZONTAL SUPPLY (RPM - VDC)

CFM	AVAILABLE EXTERNAL STATIC PRESSURE (in. wg)									
	0.2		0.4		0.6		0.8		1.0	
	RPM	Vdc	RPM	Vdc	RPM	Vdc	RPM	Vdc	RPM	Vdc
900	1037	4.7	1301	5.9	1517	6.9	1697	7.7	1855	8.5
975	1076	4.9	1331	6.1	1545	7.1	1727	7.9	1885	8.6
1050	1119	5.1	1362	6.2	1573	7.2	1755	8.0	1915	8.7
1125	1164	5.3	1395	6.4	1602	7.3	1783	8.1	1944	8.9
1200	1211	5.5	1429	6.5	1632	7.5	1812	8.3	1972	9.0
1275	1261	5.8	1466	6.7	1663	7.6	1841	8.4	2000	9.1
1350	1313	6.0	1506	6.9	1695	7.7	1870	8.5	2029	9.3
1425	1366	6.2	1548	7.1	1729	7.9	1900	8.7	2058	9.4
1500	1420	6.5	1591	7.3	1765	8.1	1932	8.8	2087	9.5

CFM	AVAILABLE EXTERNAL STATIC PRESSURE (in. wg)									
	1.2		1.4		1.6		1.8		2.0	
	RPM	Vdc	RPM	Vdc	RPM	Vdc	RPM	Vdc	RPM	Vdc
900	1995	9.1	2123	9.7	—	—	—	—	—	—
975	2027	9.3	2157	9.8	—	—	—	—	—	—
1050	2058	9.4	—	—	—	—	—	—	—	—
1125	2088	9.5	—	—	—	—	—	—	—	—
1200	2117	9.7	—	—	—	—	—	—	—	—
1275	2146	9.8	—	—	—	—	—	—	—	—
1350	—	—	—	—	—	—	—	—	—	—
1425	—	—	—	—	—	—	—	—	—	—
1500	—	—	—	—	—	—	—	—	—	—

Medium Static 1037-2190 RPM

50GC**04 THREE PHASE - HIGH STATIC — 3 TON HORIZONTAL SUPPLY (RPM - VDC)

CFM	AVAILABLE EXTERNAL STATIC PRESSURE (in. wg)									
	0.2		0.4		0.6		0.8		1.0	
	RPM	Vdc	RPM	Vdc	RPM	Vdc	RPM	Vdc	RPM	Vdc
900	1037	4.2	1301	5.2	1517	6.1	1697	6.8	1855	7.4
975	1076	4.3	1331	5.3	1545	6.2	1727	6.9	1885	7.6
1050	1119	4.5	1362	5.5	1573	6.3	1755	7.0	1915	7.7
1125	1164	4.7	1395	5.6	1602	6.4	1783	7.2	1944	7.8
1200	1211	4.9	1429	5.7	1632	6.6	1812	7.3	1972	7.9
1275	1261	5.1	1466	5.9	1663	6.7	1841	7.4	2000	8.0
1350	1313	5.3	1506	6.0	1695	6.8	1870	7.5	2029	8.1
1425	1366	5.5	1548	6.2	1729	6.9	1900	7.6	2058	8.3
1500	1420	5.7	1591	6.4	1765	7.1	1932	7.8	2087	8.4

CFM	AVAILABLE EXTERNAL STATIC PRESSURE (in. wg)									
	1.2		1.4		1.6		1.8		2.0	
	RPM	Vdc	RPM	Vdc	RPM	Vdc	RPM	Vdc	RPM	Vdc
900	1995	8.0	2123	8.5	2241	9.0	2352	9.4	2455	9.9
975	2027	8.1	2157	8.7	2276	9.1	2387	9.6	—	—
1050	2058	8.3	2189	8.8	2309	9.3	2421	9.7	—	—
1125	2088	8.4	2219	8.9	2341	9.4	2454	9.9	—	—
1200	2117	8.5	2249	9.0	2371	9.5	2485	10.0	—	—
1275	2146	8.6	2278	9.1	2401	9.6	—	—	—	—
1350	2174	8.7	2307	9.3	2431	9.8	—	—	—	—
1425	2202	8.8	2335	9.4	2459	9.9	—	—	—	—
1500	2231	9.0	2364	9.5	2488	10.0	—	—	—	—

High Static 1037-2490 RPM

50GC**05 SINGLE PHASE — 4 TON HORIZONTAL SUPPLY (RPM - BHP)

CFM	AVAILABLE EXTERNAL STATIC PRESSURE (in. wg)									
	0.2		0.4		0.6		0.8		1.0	
	RPM	BHP	RPM	BHP	RPM	BHP	RPM	BHP	RPM	BHP
1200	1092	0.14	1306	0.24	1497	0.35	1667	0.49	1819	0.64
1300	1148	0.16	1348	0.26	1533	0.38	1700	0.52	1851	0.67
1400	1207	0.18	1394	0.28	1571	0.41	1734	0.55	1882	0.70
1500	1267	0.21	1442	0.31	1612	0.44	1770	0.58	1916	0.73
1600	1329	0.24	1493	0.35	1655	0.47	1808	0.61	1951	0.77
1700	1393	0.28	1546	0.38	1700	0.51	1848	0.65	1988	0.81
1800	1458	0.32	1602	0.42	1748	0.55	1890	0.70	2026	0.86
1900	1523	0.36	1659	0.47	1797	0.60	1934	0.75	2066	0.91
2000	1590	0.41	1719	0.52	1849	0.65	1980	0.80	2108	0.96

CFM	AVAILABLE EXTERNAL STATIC PRESSURE (in. wg)									
	1.2		1.4		1.6		1.8		2.0	
	RPM	BHP	RPM	BHP	RPM	BHP	RPM	BHP	RPM	BHP
1200	1958	0.79	2089	0.96	2211	1.14	2327	1.33	2438	1.53
1300	1988	0.83	2117	1.00	2238	1.18	2352	1.37	—	—
1400	2020	0.86	2146	1.03	2266	1.22	2379	1.41	—	—
1500	2051	0.90	2177	1.08	2296	1.26	2408	1.46	—	—
1600	2084	0.94	2209	1.12	2327	1.31	2438	1.51	—	—
1700	2119	0.99	2242	1.17	2358	1.36	—	—	—	—
1800	2154	1.03	2276	1.22	2391	1.41	—	—	—	—
1900	2191	1.08	2311	1.27	2424	1.47	—	—	—	—
2000	2230	1.14	2347	1.33	2459	1.53	—	—	—	—

Standard Static 1092-1900 RPM, 0.72 Max BHP

Medium Static 1092-2170 RPM, 1.06 Max BHP

High Static 1092-2460 RPM, 1.53 Max BHP

50GC**05 SINGLE PHASE - STANDARD STATIC — 4 TON HORIZONTAL SUPPLY (RPM - VDC)

CFM	AVAILABLE EXTERNAL STATIC PRESSURE (in. wg)									
	0.2		0.4		0.6		0.8		1.0	
	RPM	Vdc	RPM	Vdc	RPM	Vdc	RPM	Vdc	RPM	Vdc
1200	1092	5.7	1306	6.9	1497	7.9	1667	8.8	1819	9.6
1300	1148	6.0	1348	7.1	1533	8.1	1700	8.9	1851	9.7
1400	1207	6.4	1394	7.3	1571	8.3	1734	9.1	1882	9.9
1500	1267	6.7	1442	7.6	1612	8.5	1770	9.3	—	—
1600	1329	7.0	1493	7.9	1655	8.7	1808	9.5	—	—
1700	1393	7.3	1546	8.1	1700	8.9	1848	9.7	—	—
1800	1458	7.7	1602	8.4	1748	9.2	1890	9.9	—	—
1900	1523	8.0	1659	8.7	1797	9.5	—	—	—	—
2000	1590	8.4	1719	9.0	1849	9.7	—	—	—	—

CFM	AVAILABLE EXTERNAL STATIC PRESSURE (in. wg)									
	1.2		1.4		1.6		1.8		2.0	
	RPM	Vdc	RPM	Vdc	RPM	Vdc	RPM	Vdc	RPM	Vdc
1200	—	—	—	—	—	—	—	—	—	—
1300	—	—	—	—	—	—	—	—	—	—
1400	—	—	—	—	—	—	—	—	—	—
1500	—	—	—	—	—	—	—	—	—	—
1600	—	—	—	—	—	—	—	—	—	—
1700	—	—	—	—	—	—	—	—	—	—
1800	—	—	—	—	—	—	—	—	—	—
1900	—	—	—	—	—	—	—	—	—	—
2000	—	—	—	—	—	—	—	—	—	—

Standard Static 1092-1900 RPM

50GC**05 SINGLE PHASE - MEDIUM STATIC — 4 TON HORIZONTAL SUPPLY (RPM - VDC)

CFM	AVAILABLE EXTERNAL STATIC PRESSURE (in. wg)									
	0.2		0.4		0.6		0.8		1.0	
	RPM	Vdc	RPM	Vdc	RPM	Vdc	RPM	Vdc	RPM	Vdc
1200	1092	5.0	1306	6.0	1497	6.9	1667	7.7	1819	8.4
1300	1148	5.3	1348	6.2	1533	7.1	1700	7.8	1851	8.5
1400	1207	5.6	1394	6.4	1571	7.2	1734	8.0	1882	8.7
1500	1267	5.8	1442	6.6	1612	7.4	1770	8.2	1916	8.8
1600	1329	6.1	1493	6.9	1655	7.6	1808	8.3	1951	9.0
1700	1393	6.4	1546	7.1	1700	7.8	1848	8.5	1988	9.2
1800	1458	6.7	1602	7.4	1748	8.1	1890	8.7	2026	9.3
1900	1523	7.0	1659	7.6	1797	8.3	1934	8.9	2066	9.5
2000	1590	7.3	1719	7.9	1849	8.5	1980	9.1	2108	9.7

CFM	AVAILABLE EXTERNAL STATIC PRESSURE (in. wg)									
	1.2		1.4		1.6		1.8		2.0	
	RPM	Vdc	RPM	Vdc	RPM	Vdc	RPM	Vdc	RPM	Vdc
1200	1958	9.0	2089	9.6	—	—	—	—	—	—
1300	1988	9.2	2117	9.8	—	—	—	—	—	—
1400	2020	9.3	2146	9.9	—	—	—	—	—	—
1500	2051	9.5	—	—	—	—	—	—	—	—
1600	2084	9.6	—	—	—	—	—	—	—	—
1700	2119	9.8	—	—	—	—	—	—	—	—
1800	2154	9.9	—	—	—	—	—	—	—	—
1900	—	—	—	—	—	—	—	—	—	—
2000	—	—	—	—	—	—	—	—	—	—

Medium Static 1092-2170 RPM

50GC**05 SINGLE PHASE - HIGH STATIC — 4 TON HORIZONTAL SUPPLY (RPM - VDC)

CFM	AVAILABLE EXTERNAL STATIC PRESSURE (in. wg)									
	0.2		0.4		0.6		0.8		1.0	
	RPM	Vdc	RPM	Vdc	RPM	Vdc	RPM	Vdc	RPM	Vdc
1200	1092	4.4	1306	5.3	1497	6.1	1667	6.8	1819	7.4
1300	1148	4.7	1348	5.5	1533	6.2	1700	6.9	1851	7.5
1400	1207	4.9	1394	5.7	1571	6.4	1734	7.0	1882	7.7
1500	1267	5.2	1442	5.9	1612	6.6	1770	7.2	1916	7.8
1600	1329	5.4	1493	6.1	1655	6.7	1808	7.3	1951	7.9
1700	1393	5.7	1546	6.3	1700	6.9	1848	7.5	1988	8.1
1800	1458	5.9	1602	6.5	1748	7.1	1890	7.7	2026	8.2
1900	1523	6.2	1659	6.7	1797	7.3	1934	7.9	2066	8.4
2000	1590	6.5	1719	7.0	1849	7.5	1980	8.0	2108	8.6

CFM	AVAILABLE EXTERNAL STATIC PRESSURE (in. wg)									
	1.2		1.4		1.6		1.8		2.0	
	RPM	Vdc	RPM	Vdc	RPM	Vdc	RPM	Vdc	RPM	Vdc
1200	1958	8.0	2089	8.5	2211	9.0	2327	9.5	2438	9.9
1300	1988	8.1	2117	8.6	2238	9.1	2352	9.6	—	—
1400	2020	8.2	2146	8.7	2266	9.2	2379	9.7	—	—
1500	2051	8.3	2177	8.8	2296	9.3	2408	9.8	—	—
1600	2084	8.5	2209	9.0	2327	9.5	2438	9.9	—	—
1700	2119	8.6	2242	9.1	2358	9.6	—	—	—	—
1800	2154	8.8	2276	9.3	2391	9.7	—	—	—	—
1900	2191	8.9	2311	9.4	2424	9.9	—	—	—	—
2000	2230	9.1	2347	9.5	2459	10.0	—	—	—	—

High Static 1092-2460 RPM

50GC**05 THREE PHASE — 4 TON HORIZONTAL SUPPLY (RPM - BHP)

CFM	AVAILABLE EXTERNAL STATIC PRESSURE (in. wg)									
	0.2		0.4		0.6		0.8		1.0	
	RPM	BHP	RPM	BHP	RPM	BHP	RPM	BHP	RPM	BHP
1200	1092	0.14	1306	0.24	1497	0.35	1667	0.49	1819	0.64
1300	1148	0.16	1348	0.26	1533	0.38	1700	0.52	1851	0.67
1400	1207	0.18	1394	0.28	1571	0.41	1734	0.55	1882	0.70
1500	1267	0.21	1442	0.31	1612	0.44	1770	0.58	1916	0.73
1600	1329	0.24	1493	0.35	1655	0.47	1808	0.61	1951	0.77
1700	1393	0.28	1546	0.38	1700	0.51	1848	0.65	1988	0.81
1800	1458	0.32	1602	0.42	1748	0.55	1890	0.70	2026	0.86
1900	1523	0.36	1659	0.47	1797	0.60	1934	0.75	2066	0.91
2000	1590	0.41	1719	0.52	1849	0.65	1980	0.80	2108	0.96

CFM	AVAILABLE EXTERNAL STATIC PRESSURE (in. wg)									
	1.2		1.4		1.6		1.8		2.0	
	RPM	BHP	RPM	BHP	RPM	BHP	RPM	BHP	RPM	BHP
1200	1958	0.79	2089	0.96	2211	1.14	2327	1.33	2438	1.53
1300	1988	0.83	2117	1.00	2238	1.18	2352	1.37	2462	1.57
1400	2020	0.86	2146	1.03	2266	1.22	2379	1.41	2487	1.61
1500	2051	0.90	2177	1.08	2296	1.26	2408	1.46	2515	1.66
1600	2084	0.94	2209	1.12	2327	1.31	2438	1.51	2544	1.71
1700	2119	0.99	2242	1.17	2358	1.36	2469	1.56	2574	1.77
1800	2154	1.03	2276	1.22	2391	1.41	2500	1.61	2604	1.82
1900	2191	1.08	2311	1.27	2424	1.47	2533	1.68	2636	1.89
2000	2230	1.14	2347	1.33	2459	1.53	2566	1.74	—	—

Standard Static 1092-1900 RPM, 0.72 Max BHP

Medium Static 1092-2170 RPM, 1.06 Max BHP

High Static 1092-2660 RPM, 1.96 Max BHP

50GC**05 THREE PHASE - STANDARD STATIC — 4 TON HORIZONTAL SUPPLY (RPM - VDC)

CFM	AVAILABLE EXTERNAL STATIC PRESSURE (in. wg)									
	0.2		0.4		0.6		0.8		1.0	
	RPM	Vdc	RPM	Vdc	RPM	Vdc	RPM	Vdc	RPM	Vdc
1200	1092	5.7	1306	6.9	1497	7.9	1667	8.8	1819	9.6
1300	1148	6.0	1348	7.1	1533	8.1	1700	8.9	1851	9.7
1400	1207	6.4	1394	7.3	1571	8.3	1734	9.1	1882	9.9
1500	1267	6.7	1442	7.6	1612	8.5	1770	9.3	—	—
1600	1329	7.0	1493	7.9	1655	8.7	1808	9.5	—	—
1700	1393	7.3	1546	8.1	1700	8.9	1848	9.7	—	—
1800	1458	7.7	1602	8.4	1748	9.2	1890	9.9	—	—
1900	1523	8.0	1659	8.7	1797	9.5	—	—	—	—
2000	1590	8.4	1719	9.0	1849	9.7	—	—	—	—

CFM	AVAILABLE EXTERNAL STATIC PRESSURE (in. wg)									
	1.2		1.4		1.6		1.8		2.0	
	RPM	Vdc	RPM	Vdc	RPM	Vdc	RPM	Vdc	RPM	Vdc
1200	—	—	—	—	—	—	—	—	—	—
1300	—	—	—	—	—	—	—	—	—	—
1400	—	—	—	—	—	—	—	—	—	—
1500	—	—	—	—	—	—	—	—	—	—
1600	—	—	—	—	—	—	—	—	—	—
1700	—	—	—	—	—	—	—	—	—	—
1800	—	—	—	—	—	—	—	—	—	—
1900	—	—	—	—	—	—	—	—	—	—
2000	—	—	—	—	—	—	—	—	—	—

Standard Static 1092-1900 RPM

50GC**05 THREE PHASE - MEDIUM STATIC — 4 TON HORIZONTAL SUPPLY (RPM - Vdc)

CFM	AVAILABLE EXTERNAL STATIC PRESSURE (in. wg)									
	0.2		0.4		0.6		0.8		1.0	
	RPM	Vdc	RPM	Vdc	RPM	Vdc	RPM	Vdc	RPM	Vdc
1200	1092	5.0	1306	6.0	1497	6.9	1667	7.7	1819	8.4
1300	1148	5.3	1348	6.2	1533	7.1	1700	7.8	1851	8.5
1400	1207	5.6	1394	6.4	1571	7.2	1734	8.0	1882	8.7
1500	1267	5.8	1442	6.6	1612	7.4	1770	8.2	1916	8.8
1600	1329	6.1	1493	6.9	1655	7.6	1808	8.3	1951	9.0
1700	1393	6.4	1546	7.1	1700	7.8	1848	8.5	1988	9.2
1800	1458	6.7	1602	7.4	1748	8.1	1890	8.7	2026	9.3
1900	1523	7.0	1659	7.6	1797	8.3	1934	8.9	2066	9.5
2000	1590	7.3	1719	7.9	1849	8.5	1980	9.1	2108	9.7

CFM	AVAILABLE EXTERNAL STATIC PRESSURE (in. wg)									
	1.2		1.4		1.6		1.8		2.0	
	RPM	Vdc	RPM	Vdc	RPM	Vdc	RPM	Vdc	RPM	Vdc
1200	1958	9.0	2089	9.6	—	—	—	—	—	—
1300	1988	9.2	2117	9.8	—	—	—	—	—	—
1400	2020	9.3	2146	9.9	—	—	—	—	—	—
1500	2051	9.5	—	—	—	—	—	—	—	—
1600	2084	9.6	—	—	—	—	—	—	—	—
1700	2119	9.8	—	—	—	—	—	—	—	—
1800	2154	9.9	—	—	—	—	—	—	—	—
1900	—	—	—	—	—	—	—	—	—	—
2000	—	—	—	—	—	—	—	—	—	—

Medium Static 1092-2170 RPM

50GC**05 THREE PHASE - HIGH STATIC — 4 TON HORIZONTAL SUPPLY (RPM - Vdc)

CFM	AVAILABLE EXTERNAL STATIC PRESSURE (in. wg)									
	0.2		0.4		0.6		0.8		1.0	
	RPM	Vdc	RPM	Vdc	RPM	Vdc	RPM	Vdc	RPM	Vdc
1200	1092	4.1	1306	4.9	1497	5.6	1667	6.3	1819	6.8
1300	1148	4.3	1348	5.1	1533	5.8	1700	6.4	1851	7.0
1400	1207	4.5	1394	5.2	1571	5.9	1734	6.5	1882	7.1
1500	1267	4.8	1442	5.4	1612	6.1	1770	6.7	1916	7.2
1600	1329	5.0	1493	5.6	1655	6.2	1808	6.8	1951	7.3
1700	1393	5.2	1546	5.8	1700	6.4	1848	6.9	1988	7.5
1800	1458	5.5	1602	6.0	1748	6.6	1890	7.1	2026	7.6
1900	1523	5.7	1659	6.2	1797	6.8	1934	7.3	2066	7.8
2000	1590	6.0	1719	6.5	1849	7.0	1980	7.4	2108	7.9

CFM	AVAILABLE EXTERNAL STATIC PRESSURE (in. wg)									
	1.2		1.4		1.6		1.8		2.0	
	RPM	Vdc	RPM	Vdc	RPM	Vdc	RPM	Vdc	RPM	Vdc
1200	1958	7.4	2089	7.9	2211	8.3	2327	8.7	2438	9.2
1300	1988	7.5	2117	8.0	2238	8.4	2352	8.8	2462	9.3
1400	2020	7.6	2146	8.1	2266	8.5	2379	8.9	2487	9.3
1500	2051	7.7	2177	8.2	2296	8.6	2408	9.1	2515	9.5
1600	2084	7.8	2209	8.3	2327	8.7	2438	9.2	2544	9.6
1700	2119	8.0	2242	8.4	2358	8.9	2469	9.3	2574	9.7
1800	2154	8.1	2276	8.6	2391	9.0	2500	9.4	2604	9.8
1900	2191	8.2	2311	8.7	2424	9.1	2533	9.5	2636	9.9
2000	2230	8.4	2347	8.8	2459	9.2	2566	9.6	—	—

High Static 1092-2660 RPM

50GC**06 SINGLE PHASE — 5 TON HORIZONTAL SUPPLY (RPM - BHP)

CFM	AVAILABLE EXTERNAL STATIC PRESSURE (in. wg)									
	0.2		0.4		0.6		0.8		1.0	
	RPM	BHP	RPM	BHP	RPM	BHP	RPM	BHP	RPM	BHP
1500	1197	0.18	1361	0.26	1524	0.36	1679	0.49	1822	0.62
1625	1271	0.21	1421	0.29	1574	0.40	1721	0.52	1860	0.66
1750	1348	0.25	1486	0.34	1627	0.44	1767	0.56	1901	0.70
1875	1426	0.30	1552	0.38	1684	0.49	1816	0.61	1945	0.75
2000	1505	0.35	1623	0.43	1745	0.54	1870	0.66	1992	0.80
2125	1585	0.40	1695	0.49	1809	0.60	1926	0.72	2043	0.86
2250	1666	0.47	1769	0.56	1876	0.67	1986	0.79	2096	0.93
2375	1748	0.54	1845	0.63	1945	0.74	2049	0.87	2153	1.01
2500	1830	0.62	1921	0.71	2016	0.82	2114	0.95	2213	1.09

CFM	AVAILABLE EXTERNAL STATIC PRESSURE (in. wg)									
	1.2		1.4		1.6		1.8		2.0	
	RPM	BHP	RPM	BHP	RPM	BHP	RPM	BHP	RPM	BHP
1500	1955	0.77	2078	0.92	2194	1.09	2304	1.26	—	—
1625	1990	0.81	2112	0.97	2227	1.13	2336	1.31	—	—
1750	2028	0.85	2148	1.01	2262	1.18	2370	1.36	—	—
1875	2069	0.90	2186	1.06	2298	1.23	—	—	—	—
2000	2111	0.95	2226	1.12	2336	1.29	—	—	—	—
2125	2157	1.02	2268	1.18	2375	1.36	—	—	—	—
2250	2206	1.08	2313	1.25	—	—	—	—	—	—
2375	2258	1.16	2361	1.33	—	—	—	—	—	—
2500	2312	1.24	—	—	—	—	—	—	—	—

Standard Static 1197-2150 RPM, 1.06 Max BHP

Medium Static 1197-2390 RPM, 1.44 Max BHP

50GC**06 SINGLE PHASE - STANDARD STATIC — 5 TON HORIZONTAL SUPPLY (RPM - VDC)

CFM	AVAILABLE EXTERNAL STATIC PRESSURE (in. wg)									
	0.2		0.4		0.6		0.8		1.0	
	RPM	Vdc	RPM	Vdc	RPM	Vdc	RPM	Vdc	RPM	Vdc
1500	1197	5.6	1361	6.3	1524	7.1	1679	7.8	1822	8.5
1625	1271	5.9	1421	6.6	1574	7.3	1721	8.0	1860	8.7
1750	1348	6.3	1486	6.9	1627	7.6	1767	8.2	1901	8.8
1875	1426	6.6	1552	7.2	1684	7.8	1816	8.4	1945	9.0
2000	1505	7.0	1623	7.5	1745	8.1	1870	8.7	1992	9.3
2125	1585	7.4	1695	7.9	1809	8.4	1926	9.0	2043	9.5
2250	1666	7.7	1769	8.2	1876	8.7	1986	9.2	2096	9.7
2375	1748	8.1	1845	8.6	1945	9.0	2049	9.5	—	—
2500	1830	8.5	1921	8.9	2016	9.4	2114	9.8	—	—

CFM	AVAILABLE EXTERNAL STATIC PRESSURE (in. wg)									
	1.2		1.4		1.6		1.8		2.0	
	RPM	Vdc	RPM	Vdc	RPM	Vdc	RPM	Vdc	RPM	Vdc
1500	1955	9.1	2078	9.7	—	—	—	—	—	—
1625	1990	9.3	2112	9.8	—	—	—	—	—	—
1750	2028	9.4	2148	10.0	—	—	—	—	—	—
1875	2069	9.6	—	—	—	—	—	—	—	—
2000	2111	9.8	—	—	—	—	—	—	—	—
2125	—	—	—	—	—	—	—	—	—	—
2250	—	—	—	—	—	—	—	—	—	—
2375	—	—	—	—	—	—	—	—	—	—
2500	—	—	—	—	—	—	—	—	—	—

Standard Static 1197-2150 RPM

50GC**06 SINGLE PHASE - MEDIUM STATIC — 5 TON HORIZONTAL SUPPLY (RPM - VDC)

CFM	AVAILABLE EXTERNAL STATIC PRESSURE (in. wg)									
	0.2		0.4		0.6		0.8		1.0	
	RPM	Vdc	RPM	Vdc	RPM	Vdc	RPM	Vdc	RPM	Vdc
1500	1197	5.0	1361	5.7	1524	6.4	1679	7.0	1822	7.6
1625	1271	5.3	1421	5.9	1574	6.6	1721	7.2	1860	7.8
1750	1348	5.6	1486	6.2	1627	6.8	1767	7.4	1901	8.0
1875	1426	6.0	1552	6.5	1684	7.0	1816	7.6	1945	8.1
2000	1505	6.3	1623	6.8	1745	7.3	1870	7.8	1992	8.3
2125	1585	6.6	1695	7.1	1809	7.6	1926	8.1	2043	8.5
2250	1666	7.0	1769	7.4	1876	7.8	1986	8.3	2096	8.8
2375	1748	7.3	1845	7.7	1945	8.1	2049	8.6	2153	9.0
2500	1830	7.7	1921	8.0	2016	8.4	2114	8.8	2213	9.3

CFM	AVAILABLE EXTERNAL STATIC PRESSURE (in. wg)									
	1.2		1.4		1.6		1.8		2.0	
	RPM	Vdc	RPM	Vdc	RPM	Vdc	RPM	Vdc	RPM	Vdc
1500	1955	8.2	2078	8.7	2194	9.2	2304	9.6	—	—
1625	1990	8.3	2112	8.8	2227	9.3	2336	9.8	—	—
1750	2028	8.5	2148	9.0	2262	9.5	2370	9.9	—	—
1875	2069	8.7	2186	9.1	2298	9.6	—	—	—	—
2000	2111	8.8	2226	9.3	2336	9.8	—	—	—	—
2125	2157	9.0	2268	9.5	2375	9.9	—	—	—	—
2250	2206	9.2	2313	9.7	—	—	—	—	—	—
2375	2258	9.4	2361	9.9	—	—	—	—	—	—
2500	2312	9.7	—	—	—	—	—	—	—	—

Medium Static 1197-2390 RPM

50GC**06 THREE PHASE — 5 TON HORIZONTAL SUPPLY (RPM - BHP)

CFM	AVAILABLE EXTERNAL STATIC PRESSURE (in. wg)									
	0.2		0.4		0.6		0.8		1.0	
	RPM	BHP	RPM	BHP	RPM	BHP	RPM	BHP	RPM	BHP
1500	1197	0.18	1361	0.26	1524	0.36	1679	0.49	1822	0.62
1625	1271	0.21	1421	0.29	1574	0.40	1721	0.52	1860	0.66
1750	1348	0.25	1486	0.34	1627	0.44	1767	0.56	1901	0.70
1875	1426	0.30	1552	0.38	1684	0.49	1816	0.61	1945	0.75
2000	1505	0.35	1623	0.43	1745	0.54	1870	0.66	1992	0.80
2125	1585	0.40	1695	0.49	1809	0.60	1926	0.72	2043	0.86
2250	1666	0.47	1769	0.56	1876	0.67	1986	0.79	2096	0.93
2375	1748	0.54	1845	0.63	1945	0.74	2049	0.87	2153	1.01
2500	1830	0.62	1921	0.71	2016	0.82	2114	0.95	2213	1.09

CFM	AVAILABLE EXTERNAL STATIC PRESSURE (in. wg)									
	1.2		1.4		1.6		1.8		2.0	
	RPM	BHP	RPM	BHP	RPM	BHP	RPM	BHP	RPM	BHP
1500	1955	0.77	2078	0.92	2194	1.09	2304	1.26	2408	1.44
1625	1990	0.81	2112	0.97	2227	1.13	2336	1.31	2440	1.49
1750	2028	0.85	2148	1.01	2262	1.18	2370	1.36	2472	1.54
1875	2069	0.90	2186	1.06	2298	1.23	2404	1.41	2506	1.60
2000	2111	0.95	2226	1.12	2336	1.29	2441	1.48	2541	1.66
2125	2157	1.02	2268	1.18	2375	1.36	2479	1.54	2578	1.73
2250	2206	1.08	2313	1.25	2417	1.43	2518	1.61	2616	1.81
2375	2258	1.16	2361	1.33	2462	1.50	2560	1.69	2656	1.89
2500	2312	1.24	2411	1.41	2509	1.59	2604	1.78	2697	1.97

Standard Static 1197-2150 RPM, 1.06 Max BHP

Medium Static 1197-2390 RPM, 1.44 Max BHP

High Static 1197-2836 RPM, 2.43 Max BHP

50GC**06 THREE PHASE - STANDARD STATIC — 5 TON HORIZONTAL SUPPLY (RPM - VDC)

CFM	AVAILABLE EXTERNAL STATIC PRESSURE (in. wg)									
	0.2		0.4		0.6		0.8		1.0	
	RPM	Vdc	RPM	Vdc	RPM	Vdc	RPM	Vdc	RPM	Vdc
1500	1197	5.6	1361	6.3	1524	7.1	1679	7.8	1822	8.5
1625	1271	5.9	1421	6.6	1574	7.3	1721	8.0	1860	8.7
1750	1348	6.3	1486	6.9	1627	7.6	1767	8.2	1901	8.8
1875	1426	6.6	1552	7.2	1684	7.8	1816	8.4	1945	9.0
2000	1505	7.0	1623	7.5	1745	8.1	1870	8.7	1992	9.3
2125	1585	7.4	1695	7.9	1809	8.4	1926	9.0	2043	9.5
2250	1666	7.7	1769	8.2	1876	8.7	1986	9.2	2096	9.7
2375	1748	8.1	1845	8.6	1945	9.0	2049	9.5	—	—
2500	1830	8.5	1921	8.9	2016	9.4	2114	9.8	—	—

CFM	AVAILABLE EXTERNAL STATIC PRESSURE (in. wg)									
	1.2		1.4		1.6		1.8		2.0	
	RPM	Vdc	RPM	Vdc	RPM	Vdc	RPM	Vdc	RPM	Vdc
1500	1955	9.1	2078	9.7	—	—	—	—	—	—
1625	1990	9.3	2112	9.8	—	—	—	—	—	—
1750	2028	9.4	2148	10.0	—	—	—	—	—	—
1875	2069	9.6	—	—	—	—	—	—	—	—
2000	2111	9.8	—	—	—	—	—	—	—	—
2125	—	—	—	—	—	—	—	—	—	—
2250	—	—	—	—	—	—	—	—	—	—
2375	—	—	—	—	—	—	—	—	—	—
2500	—	—	—	—	—	—	—	—	—	—

Standard Static 1197-2150 RPM

50GC**06 THREE PHASE - MEDIUM STATIC — 5 TON HORIZONTAL SUPPLY (RPM - Vdc)

CFM	AVAILABLE EXTERNAL STATIC PRESSURE (in. wg)									
	0.2		0.4		0.6		0.8		1.0	
	RPM	Vdc	RPM	Vdc	RPM	Vdc	RPM	Vdc	RPM	Vdc
1500	1197	5.0	1361	5.7	1524	6.4	1679	7.0	1822	7.6
1625	1271	5.3	1421	5.9	1574	6.6	1721	7.2	1860	7.8
1750	1348	5.6	1486	6.2	1627	6.8	1767	7.4	1901	8.0
1875	1426	6.0	1552	6.5	1684	7.0	1816	7.6	1945	8.1
2000	1505	6.3	1623	6.8	1745	7.3	1870	7.8	1992	8.3
2125	1585	6.6	1695	7.1	1809	7.6	1926	8.1	2043	8.5
2250	1666	7.0	1769	7.4	1876	7.8	1986	8.3	2096	8.8
2375	1748	7.3	1845	7.7	1945	8.1	2049	8.6	2153	9.0
2500	1830	7.7	1921	8.0	2016	8.4	2114	8.8	2213	9.3

CFM	AVAILABLE EXTERNAL STATIC PRESSURE (in. wg)									
	1.2		1.4		1.6		1.8		2.0	
	RPM	Vdc	RPM	Vdc	RPM	Vdc	RPM	Vdc	RPM	Vdc
1500	1955	8.2	2078	8.7	2194	9.2	2304	9.6	—	—
1625	1990	8.3	2112	8.8	2227	9.3	2336	9.8	—	—
1750	2028	8.5	2148	9.0	2262	9.5	2370	9.9	—	—
1875	2069	8.7	2186	9.1	2298	9.6	—	—	—	—
2000	2111	8.8	2226	9.3	2336	9.8	—	—	—	—
2125	2157	9.0	2268	9.5	2375	9.9	—	—	—	—
2250	2206	9.2	2313	9.7	—	—	—	—	—	—
2375	2258	9.4	2361	9.9	—	—	—	—	—	—
2500	2312	9.7	—	—	—	—	—	—	—	—

Medium Static 1197-2390 RPM

50GC**06 THREE PHASE - HIGH STATIC — 5 TON HORIZONTAL SUPPLY (RPM - Vdc)

CFM	AVAILABLE EXTERNAL STATIC PRESSURE (in. wg)									
	0.2		0.4		0.6		0.8		1.0	
	RPM	Vdc	RPM	Vdc	RPM	Vdc	RPM	Vdc	RPM	Vdc
1500	1197	4.2	1361	4.8	1524	5.4	1679	5.9	1822	6.4
1625	1271	4.5	1421	5.0	1574	5.6	1721	6.1	1860	6.6
1750	1348	4.8	1486	5.2	1627	5.7	1767	6.2	1901	6.7
1875	1426	5.0	1552	5.5	1684	5.9	1816	6.4	1945	6.9
2000	1505	5.3	1623	5.7	1745	6.2	1870	6.6	1992	7.0
2125	1585	5.6	1695	6.0	1809	6.4	1926	6.8	2043	7.2
2250	1666	5.9	1769	6.2	1876	6.6	1986	7.0	2096	7.4
2375	1748	6.2	1845	6.5	1945	6.9	2049	7.2	2153	7.6
2500	1830	6.5	1921	6.8	2016	7.1	2114	7.5	2213	7.8

CFM	AVAILABLE EXTERNAL STATIC PRESSURE (in. wg)									
	1.2		1.4		1.6		1.8		2.0	
	RPM	Vdc	RPM	Vdc	RPM	Vdc	RPM	Vdc	RPM	Vdc
1500	1955	6.9	2078	7.3	2194	7.7	2304	8.1	2408	8.5
1625	1990	7.0	2112	7.4	2227	7.9	2336	8.2	2440	8.6
1750	2028	7.2	2148	7.6	2262	8.0	2370	8.4	2472	8.7
1875	2069	7.3	2186	7.7	2298	8.1	2404	8.5	2506	8.8
2000	2111	7.4	2226	7.8	2336	8.2	2441	8.6	2541	9.0
2125	2157	7.6	2268	8.0	2375	8.4	2479	8.7	2578	9.1
2250	2206	7.8	2313	8.2	2417	8.5	2518	8.9	2616	9.2
2375	2258	8.0	2361	8.3	2462	8.7	2560	9.0	2656	9.4
2500	2312	8.2	2411	8.5	2509	8.8	2604	9.2	2697	9.5

High Static 1197-2836 RPM

GENERAL FAN PERFORMANCE NOTES

1. Interpolation is permissible. Do not extrapolate.
2. External static pressure is the static pressure difference between the return duct and the supply duct plus the static pressure caused by any FIOPs or accessories.
3. Tabular data accounts for pressure loss due to clean filters, unit casing, wet coils, and highest gas heat exchanger (when gas heat unit).
4. Factory options and accessories may effect static pressure losses. Gas heat unit fan tables assume highest gas heat models; for fan selections with low or medium heat models, the user must deduct low and medium heat static pressures. Selection software is available, through your salesperson, to help you select the best motor/drive combination for your application.
5. The fan performance tables offer motor/drive recommendations. In cases when two motor/drive combinations would work, Carrier recommends the lower horsepower option.
6. For information on the electrical properties of Carrier motors, please see the Electrical information section of this book.
7. For more information on the performance limits of Carrier motors, see the application data section of this book.
8. The EPACT (Energy Policy Act of 1992) regulates energy requirements for specific types of indoor fan motors. Motors regulated by EPACT include any general purpose, T-frame (three-digit, 143 and larger), single-speed, foot mounted, polyphase, squirrel cage induction motors of NEMA (National Electrical Manufacturers Association) design A and B, manufactured for use in the United States. Ranging from 1 to 200 Hp, these continuous-duty motors operate on 230 and 460 volt, 60 Hz power. If a motor does not fit into these specifications, the motor does not have to be replaced by an EPACT compliant energy-efficient motor. Variable-speed motors are exempt from EPACT compliance requirements.

Legend and Notes

Applicable for Electrical Data Tables on pages 90 to 114

LEGEND

BRKR	— Circuit Breaker
C.O.	— Convenience Outlet
FLA	— Full Load Amps
IFM	— Indoor Fan Motor
LRA	— Locked Rotor Amps
MCA	— Minimum Circuit Amps
P.E.	— Power Exhaust
Pwr'd fr/unit	— Powered From Unit
PWRD C.O.	— Powered Convenience Outlet
RLA	— Rated Load Amps
UNPWR C.O.	— Unpowered Convenience Outlet

NOTES:

1. In compliance with NEC requirements for multi-motor and combination load equipment (refer to NEC Articles 430 and 440), the overcurrent protective device for the unit shall be fuse or HACR breaker. Canadian units may be fuse or circuit breaker.
2. For 208/230 v units, where one value is shown it is the same for either 208 or 230 volts.
3. **Unbalanced 3-Phase Supply Voltage**
Never operate a motor where a phase imbalance in supply voltage is greater than 2%. Use the following formula to determine the percentage of voltage imbalance.

$$\% \text{ Voltage Imbalance} = 100 \times \frac{\text{max voltage deviation from average voltage}}{\text{average voltage}}$$

Example: Supply voltage is 230-3-60

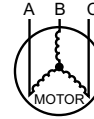

AB = 224 v
BC = 231 v
AC = 226 v

$$\begin{aligned} \text{Average Voltage} &= \frac{(224 + 231 + 226)}{3} = \frac{681}{3} \\ &= 227 \end{aligned}$$

Determine maximum deviation from average voltage.

$$(AB) 227 - 224 = 3 \text{ v}$$

$$(BC) 231 - 227 = 4 \text{ v}$$

$$(AC) 227 - 226 = 1 \text{ v}$$

Maximum deviation is 4 v.

Determine percent of voltage imbalance.

$$\begin{aligned} \% \text{ Voltage Imbalance} &= 100 \times \frac{4}{227} \\ &= 1.76\% \end{aligned}$$

This amount of phase imbalance is satisfactory as it is below the maximum allowable 2%.

IMPORTANT: If the supply voltage phase imbalance is more than 2%, contact your local electric utility company immediately.

Electrical data (cont)



48/50GC**04-06 COOLING ELECTRICAL DATA

48/50GC UNIT	V-Ph-Hz	UNIT VOLTAGE		COMPRESSOR		OFM (EA)		IFM			COMBUSTION FAN MOTOR (48GC ONLY)	POWER EXHAUST		
		RANGE		RLA	LRA	WATTS	FLA	TYPE	EFFCY AT FULL LOAD	FLA	FLA	KIT QTY	FLA (EA KIT)	
		MIN	MAX											
**04	208-1-60	187	253	14.1	84	275	1.5	STD	84%	3.4	0.48	1	1.9	
								MED	84%	5.1				
								HIGH	85%	7.3				
	230-1-60	187	253	14.1	84	275	1.5	1.5	STD	84%	3.4	0.48	1	1.9
									MED	84%	5.1			
									HIGH	85%	7.3			
	208-3-60	187	253	11.6	73	275	1.5	1.5	STD	84%	3.4	0.48	1	1.9
									MED	84%	5.1			
									HIGH	85%	7.3			
	230-3-60	187	253	11.6	73	275	1.5	1.5	STD	84%	3.4	0.48	1	1.9
									MED	84%	5.1			
									HIGH	85%	7.3			
	460-3-60	414	506	5.7	38	275	0.8	0.8	STD	85%	1.2	0.25	1	1.0
									MED	86%	1.5			
									HIGH	88%	2.4			
	575-3-60	518	633	4.0	26	275	0.6	0.6	STD	84%	0.8	0.24	1	1.9
									MED	84%	1.1			
									HIGH	85%	1.5			
**05	208-1-60	187	253	20.4	122	275	1.5	STD	87%	5.0	0.48	1	1.9	
								MED	86%	7.1				
								HIGH	84%	8.8				
	230-1-60	187	253	20.4	122	275	1.5	1.5	STD	87%	5.0	0.48	1	1.9
									MED	86%	7.1			
									HIGH	84%	8.8			
	208-3-60	187	253	14.0	83	275	1.5	1.5	STD	87%	5.0	0.48	1	1.9
									MED	86%	7.1			
									HIGH	85%	5.1			
	230-3-60	187	253	14.0	83	275	1.5	1.5	STD	87%	5.0	0.48	1	1.9
									MED	86%	7.1			
									HIGH	85%	5.1			
	460-3-60	414	506	6.4	41	275	0.8	0.8	STD	85%	1.2	0.25	1	1.0
									MED	86%	1.5			
									HIGH	88%	2.4			
	575-3-60	518	633	4.6	33	275	0.6	0.6	STD	84%	1.1	0.24	1	1.9
									MED	85%	1.5			
									HIGH	88%	2.1			
**06	208-1-60	187	253	22.9	147	275	1.5	STD	86%	7.2	0.48	1	1.9	
								MED	84%	8.6				
	230-1-60	187	253	22.9	147	275	1.5	1.5	STD	86%	7.2	0.48	1	1.9
									MED	84%	8.6			
	208-3-60	187	253	16.2	110	275	1.5	1.5	STD	86%	7.2	0.48	1	1.9
									MED	84%	8.6			
	230-3-60	187	253	16.2	110	275	1.5	1.5	STD	86%	7.2	0.48	1	1.9
									MED	84%	8.6			
	460-3-60	414	506	7.6	52	275	0.8	0.8	STD	86%	1.5	0.25	1	1.0
									MED	86%	1.9			
	575-3-60	518	633	5.3	39	275	0.6	0.6	STD	84%	1.5	0.24	1	1.9
									MED	85%	1.8			
									HIGH	87%	2.5			

48GC**04-06 MCA MOCP ELECTRICAL DATA

48GC UNIT SIZE	NOM. V-PH-HZ	IFM TYPE	NO CONVENIENCE OUTLET OR UNPOWERED CONVENIENCE OUTLET							
			NO POWER EXHAUST				w/ POWER EXHAUST (powered from unit)			
			MCA	FUSE OR HACR BREAKER	DISCONNECT SIZE		MCA	FUSE OR HACR BREAKER	DISCONNECT SIZE	
					FLA	LRA			FLA	LRA
**04	208/230-1-60	STD	23	30	21	92	24	30	24	94
		MED	24	30	23	94	26	30	25	96
		HIGH	26	30	25	97	28	40	27	99
	208/230-3-60	STD	19	30	19	81	21	30	21	83
		MED	21	30	20	83	23	30	22	85
		HIGH	23	30	22	86	24	30	24	88
	460-3-60	STD	9	15	8	41	10	15	10	42
		MED	10	15	9	42	11	15	10	43
		HIGH	10	15	9	42	11	15	10	43
	575-3-60	STD	7	15	6	29	9	15	8	31
		MED	7	15	7	30	9	15	9	32
		HIGH	8	15	7	30	9	15	9	32
**05	208/230-1-60	STD	32	50	30	132	34	50	33	134
		MED	34	50	32	135	35	50	34	137
		HIGH	36	50	35	138	38	50	37	140
	208/230-3-60	STD	24	30	23	93	26	30	25	95
		MED	26	30	25	96	27	40	27	98
		HIGH	25	30	24	94	26	30	26	96
	460-3-60	STD	10	15	10	45	11	15	11	46
		MED	11	15	10	45	12	15	11	46
		HIGH	12	15	11	46	13	15	12	47
	575-3-60	STD	8	15	7	37	10	15	9	39
		MED	8	15	8	37	10	15	10	39
		HIGH	9	15	9	38	11	15	11	40
**06	208/230-1-60	STD	37	50	35	160	39	60	38	162
		MED	39	60	38	163	41	60	40	165
	208/230-3-60	STD	29	40	28	123	31	45	30	125
		MED	31	45	30	126	33	45	32	128
		HIGH	29	40	28	123	31	45	30	125
	460-3-60	STD	12	15	11	56	13	20	13	57
		MED	13	15	12	57	14	20	13	58
		HIGH	14	20	13	58	15	20	14	59
	575-3-60	STD	9	15	9	43	11	15	11	45
		MED	9	15	9	43	11	15	11	45
		HIGH	10	15	10	45	12	15	12	47

Electrical data (cont)



48GC**04-06 MCA MOCP ELECTRICAL DATA (cont)

48GC UNIT SIZE	NOM. V-PH-HZ	IFM TYPE	w/ POWERED CONVENIENCE OUTLET							
			NO POWER EXHAUST				w/ POWER EXHAUST (powered from unit)			
			MCA	FUSE OR HACR BREAKER	DISCONNECT SIZE		MCA	FUSE OR HACR BREAKER	DISCONNECT SIZE	
					FLA	LRA			FLA	LRA
**04	208/230-3-60	STD	24	30	24	86	26	30	26	88
		MED	26	30	26	88	28	35	28	90
		HIGH	27	30	28	91	29	40	30	93
	460-3-60	STD	11	15	11	43	12	15	12	44
		MED	12	15	11	44	13	15	13	45
		HIGH	12	15	12	44	13	15	13	45
	575-3-60	STD	9	15	8	31	10	15	10	33
		MED	9	15	9	32	11	15	11	34
		HIGH	9	15	9	32	11	15	11	34
**05	208/230-3-60	STD	29	40	29	98	31	40	31	100
		MED	30	40	30	101	32	45	33	103
		HIGH	29	40	29	99	31	40	31	101
	460-3-60	STD	13	15	12	47	14	15	13	48
		MED	13	15	13	47	14	20	14	48
		HIGH	14	20	14	48	15	20	15	49
	575-3-60	STD	10	15	9	39	12	15	11	41
		MED	10	15	10	39	12	15	12	41
		HIGH	11	15	10	40	13	15	13	42
**06	208/230-3-60	STD	33	45	33	128	35	50	35	130
		MED	36	50	36	131	38	50	38	133
		HIGH	33	45	33	128	35	50	35	130
	460-3-60	STD	14	20	14	58	15	20	15	59
		MED	15	20	14	59	16	20	16	60
		HIGH	16	20	16	60	17	20	17	61
	575-3-60	STD	11	15	10	45	13	15	13	47
		MED	11	15	11	45	13	15	13	47
		HIGH	12	15	12	47	14	15	14	49

Electrical data (cont)



48GC**04-06 MCA MOCP ELECTRICAL DATA WITH FACTORY-INSTALLED HACR BREAKER

48GC UNIT SIZE	NOM. V-PH-HZ	IFM TYPE	NO CONVENIENCE OUTLET OR UNPOWERED CONVENIENCE OUTLET							
			NO POWER EXHAUST				w/ POWER EXHAUST (powered from unit)			
			MCA	HACR BREAKER	DISCONNECT SIZE		MCA	HACR BREAKER	DISCONNECT SIZE	
					FLA	LRA			FLA	LRA
**04	208/230-1-60	STD	23	30	21	92	24	30	24	94
		MED	24	30	23	94	26	30	25	96
		HIGH	26	30	25	97	28	40	27	99
	208/230-3-60	STD	19	30	19	81	21	30	21	83
		MED	21	30	20	83	23	30	22	85
		HIGH	23	30	22	86	24	30	24	88
	460-3-60	STD	9	15	8	41	10	15	10	42
		MED	10	15	9	42	11	15	10	43
		HIGH	10	15	9	42	11	15	10	43
	575-3-60	STD	7	15	6	29	9	15	8	31
		MED	7	15	7	30	9	15	9	32
		HIGH	8	15	7	30	9	15	9	32
**05	208/230-1-60	STD	32	50	30	132	34	50	33	134
		MED	34	50	32	135	35	50	34	137
		HIGH	36	50	35	138	38	50	37	140
	208/230-3-60	STD	24	30	23	93	26	30	25	95
		MED	26	30	25	96	27	40	27	98
		HIGH	25	30	24	94	26	30	26	96
	460-3-60	STD	10	15	10	45	11	15	11	46
		MED	11	15	10	45	12	15	11	46
		HIGH	12	15	11	46	13	15	12	47
	575-3-60	STD	8	15	7	37	10	15	9	39
		MED	8	15	8	37	10	15	10	39
		HIGH	9	15	9	38	11	15	11	40
**06	208/230-1-60	STD	37	50	35	160	39	60	38	162
		MED	39	60	38	163	41	60	40	165
	208/230-3-60	STD	29	40	28	123	31	45	30	125
		MED	31	45	30	126	33	45	32	128
	460-3-60	HIGH	29	40	28	123	31	45	30	125
		STD	12	15	11	56	13	20	13	57
		MED	13	15	12	57	14	20	13	58
	575-3-60	HIGH	14	20	13	58	15	20	14	59
		STD	9	15	9	43	11	15	11	45
		MED	9	15	9	43	11	15	11	45
	HIGH	10	15	10	45	12	15	12	47	

Electrical data (cont)



48GC**04-06 MCA MOCP ELECTRICAL DATA WITH FACTORY-INSTALLED HACR BREAKER (cont)

48GC UNIT SIZE	NOM. V-PH-HZ	IFM TYPE	w/ POWERED CONVENIENCE OUTLET							
			NO POWER EXHAUST				w/ POWER EXHAUST (powered from unit)			
			MCA	HACR BREAKER	DISCONNECT SIZE		MCA	HACR BREAKER	DISCONNECT SIZE	
					FLA	LRA			FLA	LRA
**04	208/230-3-60	STD	24	30	24	86	26	30	26	88
		MED	26	30	26	88	28	35	28	90
		HIGH	27	30	28	91	29	40	30	93
	460-3-60	STD	11	15	11	43	12	15	12	44
		MED	12	15	11	44	13	15	13	45
		HIGH	12	15	12	44	13	15	13	45
	575-3-60	STD	9	15	8	31	10	15	10	33
		MED	9	15	9	32	11	15	11	34
		HIGH	9	15	9	32	11	15	11	34
**05	208/230-3-60	STD	29	40	29	98	31	40	31	100
		MED	30	40	30	101	32	45	33	103
		HIGH	29	40	29	99	31	40	31	101
	460-3-60	STD	13	15	12	47	14	15	13	48
		MED	13	15	13	47	14	20	14	48
		HIGH	14	20	14	48	15	20	15	49
	575-3-60	STD	10	15	9	39	12	15	11	41
		MED	10	15	10	39	12	15	12	41
		HIGH	11	15	10	40	13	15	13	42
**06	208/230-3-60	STD	33	45	33	128	35	50	35	130
		MED	36	50	36	131	38	50	38	133
		HIGH	33	45	33	128	35	50	35	130
	460-3-60	STD	14	20	14	58	15	20	15	59
		MED	15	20	14	59	16	20	16	60
		HIGH	16	20	16	60	17	20	17	61
	575-3-60	STD	11	15	10	45	13	15	13	47
		MED	11	15	11	45	13	15	13	47
		HIGH	12	15	12	47	14	15	14	49

50GC**04 MCA MOCP ELECTRICAL DATA

50GC UNIT SIZE	NOM. V-Ph-Hz	IFM TYPE	ELECTRIC HEATER			NO CONVENIENCE OUTLET or UNPOWERED CONVENIENCE OUTLET							
			CRHEATER ***A00	NOM (kW)	FLA	NO POWER EXHAUST				w/ POWER EXHAUST (powered from unit)			
						MCA	FUSE OR HACR BRKR	DISCONNECT SIZE		MCA	FUSE OR HACR BRKR	DISCONNECT SIZE	
								FLA	LRA			FLA	LRA
**04	208/230-1-60	STD	NONE	—	—	23	30	22	93	25	30	24	95
			323A	3.3/4.4	15.9/18.3	25/28	30/30	22/25	93/93	27/30	30/30	24/27	95/95
			324A	4.9/6.5	23.5/27.1	34/39	35/40	31/35	93/93	36/41	40/45	33/37	95/95
			325A	6.5/8.7	31.4/36.3	44/50	45/50	40/46	93/93	46/52	50/60	42/48	95/95
			326A	7.9/10.5	37.9/43.8	52/59	60/60	47/54	93/93	54/62	60/70	50/56	95/95
			327A	9.8/13.0	46.9/54.2	63/72	70/80	58/66	93/93	66/75	70/80	60/68	95/95
		MED	NONE	—	—	25	30	24	95	27	30	26	97
			323A	3.3/4.4	15.9/18.3	27/30	30/30	24/27	95/95	29/32	30/40	26/29	97/97
			324A	4.9/6.5	23.5/27.1	36/41	40/45	33/37	95/95	39/43	40/45	35/39	97/97
			325A	6.5/8.7	31.4/36.3	46/52	50/60	42/48	95/95	48/55	50/60	44/50	97/97
			326A	7.9/10.5	37.9/43.8	54/62	60/70	49/56	95/95	57/64	60/70	52/58	97/97
			327A	9.8/13.0	46.9/54.2	65/75	70/80	60/68	95/95	68/77	70/80	62/70	97/97
		HIGH	NONE	—	—	27	30	26	98	29	40	29	100
			323A	3.3/4.4	15.9/18.3	29/32	30/40	27/29	98/98	32/35	40/40	29/32	100/100
			324A	4.9/6.5	23.5/27.1	39/43	40/45	35/40	98/98	41/46	45/50	38/42	100/100
			325A	6.5/8.7	31.4/36.3	49/55	50/60	45/50	98/98	51/57	60/60	47/52	100/100
			326A	7.9/10.5	37.9/43.8	57/64	60/70	52/59	98/98	59/67	60/70	54/61	100/100
			327A	9.8/13.0	46.9/54.2	68/77	70/80	62/71	98/98	71/80	80/80	65/73	100/100
	208/230-3-60	STD	NONE	—	—	20	30	19	82	22	30	21	84
			323A	3.3/4.4	9.2/10.6	20/20	30/30	19/19	82/82	22/22	30/30	21/21	84/84
			324A	4.9/6.5	13.6/15.6	22/24	30/30	20/22	82/82	24/27	30/30	22/24	84/84
			325A	6.5/8.7	18.1/20.9	27/31	30/35	25/28	82/82	30/33	30/35	27/30	84/84
			326A	7.9/10.5	21.9/25.3	32/36	35/40	29/33	82/82	34/39	35/40	31/35	84/84
			328A	12.0/16.0	33.4/38.5	46/53	50/60	42/48	82/82	49/55	50/60	45/50	84/84
		MED	NONE	—	—	22	30	21	84	23	30	23	86
			323A	3.3/4.4	9.2/10.6	22/22	30/30	21/21	84/84	23/23	30/30	23/23	86/86
			324A	4.9/6.5	13.6/15.6	24/26	30/30	22/24	84/84	26/29	30/30	24/26	86/86
			325A	6.5/8.7	18.1/20.9	29/33	30/35	27/30	84/84	32/35	35/35	29/32	86/86
			326A	7.9/10.5	21.9/25.3	34/38	35/40	31/35	84/84	37/41	40/45	33/37	86/86
			328A	12.0/16.0	33.4/38.5	49/55	50/60	44/50	84/84	51/57	60/60	46/52	86/86
		HIGH	NONE	—	—	24	30	23	87	26	30	26	89
			323A	3.3/4.4	9.2/10.6	24/24	30/30	23/23	87/87	26/26	30/30	26/26	89/89
			324A	4.9/6.5	13.6/15.6	27/29	30/30	24/26	87/87	29/31	30/35	26/29	89/89
			325A	6.5/8.7	18.1/20.9	32/36	35/40	29/32	87/87	35/38	35/40	31/35	89/89
			326A	7.9/10.5	21.9/25.3	37/41	40/45	34/37	87/87	39/44	40/45	36/40	89/89
			328A	12.0/16.0	33.4/38.5	51/58	60/60	47/53	87/87	54/60	60/60	49/55	89/89
	460-3-60	STD	NONE	—	—	9	15	9	41	10	15	10	42
			333A	6.0	7.2	11	15	9	41	12	15	10	42
			334A	8.8	10.6	15	15	13	41	16	20	14	42
			335A	11.5	13.8	19	20	17	41	20	20	18	42
			336A	14.0	16.8	23	25	20	41	24	25	22	42
			NONE	—	—	10	15	9	42	11	15	10	43
		MED	333A	6.0	7.2	11	15	10	42	12	15	11	43
			334A	8.8	10.6	15	15	14	42	16	20	15	43
			335A	11.5	13.8	19	20	17	42	20	25	18	43
			336A	14.0	16.8	23	25	21	42	24	25	22	43
			NONE	—	—	10	15	9	42	11	15	10	43
			333A	6.0	7.2	11	15	10	42	13	15	11	43
HIGH		334A	8.8	10.6	16	20	14	42	17	20	15	43	
		335A	11.5	13.8	20	20	18	42	21	25	19	43	
		336A	14.0	16.8	23	25	21	42	25	25	22	43	
		NONE	—	—	7	15	6	29	9	15	8	31	
		339A	10.0	9.6	13	15	12	29	16	20	14	31	
		340A	15.0	14.4	19	20	17	29	22	25	20	31	
575-3-60	MED	NONE	—	—	7	15	7	30	9	15	9	32	
		339A	10.0	9.6	14	15	12	30	16	20	14	32	
		340A	15.0	14.4	20	20	18	30	22	25	20	32	
	HIGH	NONE	—	—	8	15	7	30	9	15	9	32	
		339A	10.0	9.6	14	15	13	30	17	20	15	32	
		340A	15.0	14.4	20	20	18	30	23	25	20	32	

50GC**04 MCA MOCP ELECTRICAL DATA (cont)

50GC UNIT SIZE	NOM. V-Ph-Hz	IFM TYPE	ELECTRIC HEATER			w/ POWERED CONVENIENCE OUTLET							
			CRHEATER ***A00	NOM (kW)	FLA	NO POWER EXHAUST				w/ POWER EXHAUST (powered from unit)			
						MCA	FUSE OR HACR BRKR	DISCONNECT SIZE		MCA	FUSE OR HACR BRKR	DISCONNECT SIZE	
							FLA	LRA			FLA	LRA	
**04	208/230-3-60	STD	NONE	—	—	25	30	24	87	27	30	27	89
			323A	3.3/4.4	9.2/10.6	25/25	30/30	24/24	87/87	27/27	30/30	27/27	89/89
			324A	4.9/6.5	13.6/15.6	28/30	30/30	25/27	87/87	30/33	30/35	27/30	89/89
			325A	6.5/8.7	18.1/20.9	33/37	35/40	30/33	87/87	36/39	40/40	32/36	89/89
			326A	7.9/10.5	21.9/25.3	38/42	40/45	35/39	87/87	40/45	45/45	37/41	89/89
			328A	12.0/16.0	33.4/38.5	52/59	60/60	48/54	87/87	55/61	60/70	50/56	89/89
		MED	NONE	—	—	26	30	26	89	28	35	29	91
			323A	3.3/4.4	9.2/10.6	26/26	30/30	26/26	89/89	28/28	35/35	29/29	91/91
			324A	4.9/6.5	13.6/15.6	30/32	30/35	27/29	89/89	32/35	35/35	29/32	91/91
			325A	6.5/8.7	18.1/20.9	35/39	40/40	32/35	89/89	38/41	40/45	34/38	91/91
			326A	7.9/10.5	21.9/25.3	40/44	40/45	37/40	89/89	43/47	45/50	39/43	91/91
			328A	12.0/16.0	33.4/38.5	55/61	60/70	50/56	89/89	57/63	60/70	52/58	91/91
		HIGH	NONE	—	—	29	35	29	92	30	40	31	94
			323A	3.3/4.4	9.2/10.6	29/29	35/35	29/29	92/92	30/31	40/40	31/31	94/94
			324A	4.9/6.5	13.6/15.6	33/35	35/35	30/32	92/92	35/37	40/40	32/34	94/94
			325A	6.5/8.7	18.1/20.9	38/42	40/45	35/38	92/92	41/44	45/45	37/40	94/94
			326A	7.9/10.5	21.9/25.3	43/47	45/50	39/43	92/92	45/50	45/50	41/45	94/94
			328A	12.0/16.0	33.4/38.5	57/64	60/70	52/58	92/92	60/66	60/70	55/60	94/94
	460-3-60	STD	NONE	—	—	11	15	11	43	12	15	12	44
			333A	6.0	7.2	13	15	12	43	15	15	13	44
			334A	8.8	10.6	18	20	16	43	19	20	17	44
			335A	11.5	13.8	22	25	19	43	23	25	21	44
			336A	14.0	16.8	25	25	23	43	27	30	24	44
			NONE	—	—	12	15	11	44	13	15	13	45
		MED	333A	6.0	7.2	14	15	12	44	15	15	13	45
			334A	8.8	10.6	18	20	16	44	19	20	17	45
			335A	11.5	13.8	22	25	20	44	23	25	21	45
			336A	14.0	16.8	26	30	23	44	27	30	24	45
			NONE	—	—	12	15	12	44	13	15	13	45
			333A	6.0	7.2	14	15	13	44	15	15	14	45
		HIGH	334A	8.8	10.6	18	20	16	44	20	20	18	45
			335A	11.5	13.8	22	25	20	44	24	25	21	45
			336A	14.0	16.8	26	30	24	44	27	30	25	45
			NONE	—	—	9	15	8	31	10	15	10	33
			339A	10.0	9.6	16	20	14	31	18	20	16	33
			340A	15.0	14.4	22	25	19	31	24	25	22	33
575-3-60	STD	NONE	—	—	9	15	9	32	11	15	11	34	
		339A	10.0	9.6	16	20	14	32	18	20	16	34	
		340A	15.0	14.4	22	25	20	32	24	25	22	34	
	MED	NONE	—	—	9	15	9	32	11	15	11	34	
		339A	10.0	9.6	16	20	14	32	18	20	16	34	
		340A	15.0	14.4	22	25	20	32	24	25	22	34	
HIGH	NONE	—	—	9	15	9	32	11	15	11	34		
	339A	10.0	9.6	16	20	15	32	19	20	17	34		
	340A	15.0	14.4	22	25	20	32	25	25	22	34		

50GC**04 MCA MOC P ELECTRICAL DATA — WITH FACTORY-INSTALLED HACR BREAKER

50GC UNIT SIZE	NOM. V-Ph-Hz	IFM TYPE	ELECTRIC HEATER			NO CONVENIENCE OUTLET or UNPOWERED CONVENIENCE OUTLET							
			CRHEATER ***A00	NOM (kW)	FLA	NO POWER EXHAUST				w/ POWER EXHAUST (powered from unit)			
						MCA	HACR BRKR	DISCONNECT SIZE		MCA	HACR BRKR	DISCONNECT SIZE	
								FLA	LRA			FLA	LRA
**04	208/230-1-60	STD	NONE	—	—	23	30	22	93	25	30	24	95
			323A	3.3/4.4	15.9/18.3	28/28	30/30	22/25	93/93	30/30	30/30	24/27	95/95
			324A	4.9/6.5	23.5/27.1	39/39	40/40	31/35	93/93	41/41	45/45	33/37	95/95
			325A	6.5/8.7	31.4/36.3	50/50	50/50	40/46	93/93	52/52	60/60	42/48	95/95
			326A	7.9/10.5	37.9/43.8	59/59	60/60	47/54	93/93	62/62	70/70	50/56	95/95
			327A	9.8/13.0	46.9/54.2	72/72	80/80	58/66	93/93	75/75	80/80	60/68	95/95
		MED	NONE	—	—	25	30	24	95	27	30	26	97
			323A	3.3/4.4	15.9/18.3	30/30	30/30	24/27	95/95	32/32	40/40	26/29	97/97
			324A	4.9/6.5	23.5/27.1	41/41	45/45	33/37	95/95	43/43	45/45	35/39	97/97
			325A	6.5/8.7	31.4/36.3	52/52	60/60	42/48	95/95	55/55	60/60	44/50	97/97
			326A	7.9/10.5	37.9/43.8	62/62	70/70	49/56	95/95	64/64	70/70	52/58	97/97
			327A	9.8/13.0	46.9/54.2	75/75	80/80	60/68	95/95	77/77	80/80	62/70	97/97
		HIGH	NONE	—	—	27	30	26	98	29	40	29	100
			323A	3.3/4.4	15.9/18.3	32/32	40/40	27/29	98/98	35/35	40/40	29/32	100/100
			324A	4.9/6.5	23.5/27.1	43/43	45/45	35/40	98/98	46/46	50/50	38/42	100/100
			325A	6.5/8.7	31.4/36.3	55/55	60/60	45/50	98/98	57/57	60/60	47/52	100/100
			326A	7.9/10.5	37.9/43.8	64/64	70/70	52/59	98/98	67/67	70/70	54/61	100/100
			327A	9.8/13.0	46.9/54.2	77/77	80/80	62/71	98/98	80/80	80/80	65/73	100/100
**04	208/230-3-60	STD	NONE	—	—	20	30	19	82	22	30	21	84
			323A	3.3/4.4	9.2/10.6	20/20	30/30	19/19	82/82	22/22	30/30	21/21	84/84
			324A	4.9/6.5	13.6/15.6	24/24	30/30	20/22	82/82	27/27	30/30	22/24	84/84
			325A	6.5/8.7	18.1/20.9	31/31	35/35	25/28	82/82	33/33	35/35	27/30	84/84
			326A	7.9/10.5	21.9/25.3	36/36	40/40	29/33	82/82	39/39	40/40	31/35	84/84
			328A	12.0/16.0	33.4/38.5	53/53	60/60	42/48	82/82	55/55	60/60	45/50	84/84
		MED	NONE	—	—	22	30	21	84	23	30	23	86
			323A	3.3/4.4	9.2/10.6	22/22	30/30	21/21	84/84	23/23	30/30	23/23	86/86
			324A	4.9/6.5	13.6/15.6	26/26	30/30	22/24	84/84	29/29	30/30	24/26	86/86
			325A	6.5/8.7	18.1/20.9	33/33	35/35	27/30	84/84	35/35	35/35	29/32	86/86
			326A	7.9/10.5	21.9/25.3	38/38	40/40	31/35	84/84	41/41	45/45	33/37	86/86
			328A	12.0/16.0	33.4/38.5	55/55	60/60	44/50	84/84	57/57	60/60	46/52	86/86
		HIGH	NONE	—	—	24	30	23	87	26	30	26	89
			323A	3.3/4.4	9.2/10.6	24/24	30/30	23/23	87/87	26/26	30/30	26/26	89/89
			324A	4.9/6.5	13.6/15.6	29/29	30/30	24/26	87/87	31/31	35/35	26/29	89/89
			325A	6.5/8.7	18.1/20.9	36/36	40/40	29/32	87/87	38/38	40/40	31/35	89/89
			326A	7.9/10.5	21.9/25.3	41/41	45/45	34/37	87/87	44/44	45/45	36/40	89/89
			328A	12.0/16.0	33.4/38.5	58/58	60/60	47/53	87/87	60/60	60/60	49/55	89/89
**04	460-3-60	STD	NONE	—	—	9	15	9	41	10	15	10	42
			333A	6.0	7.2	11	15	9	41	12	15	10	42
			334A	8.8	10.6	15	15	13	41	16	20	14	42
			335A	11.5	13.8	19	20	17	41	20	20	18	42
			336A	14.0	16.8	23	25	20	41	24	25	22	42
			NONE	—	—	10	15	9	42	11	15	10	43
		MED	333A	6.0	7.2	11	15	10	42	12	15	11	43
			334A	8.8	10.6	15	15	14	42	16	20	15	43
			335A	11.5	13.8	19	20	17	42	20	25	18	43
			336A	14.0	16.8	23	25	21	42	24	25	22	43
			NONE	—	—	10	15	9	42	11	15	10	43
			333A	6.0	7.2	11	15	10	42	13	15	11	43
		HIGH	334A	8.8	10.6	16	20	14	42	17	20	15	43
			335A	11.5	13.8	20	20	18	42	21	25	19	43
			336A	14.0	16.8	23	25	21	42	25	25	22	43
			NONE	—	—	7	15	6	29	9	15	8	31
			339A	10.0	9.6	13	15	12	29	16	20	14	31
			340A	15.0	14.4	19	20	17	29	22	25	20	31
**04	575-3-60	STD	NONE	—	—	7	15	7	30	9	15	9	32
			339A	10.0	9.6	14	15	12	30	16	20	14	32
			340A	15.0	14.4	20	20	18	30	22	25	20	32
		MED	NONE	—	—	8	15	7	30	9	15	9	32
			339A	10.0	9.6	14	15	12	30	16	20	14	32
			340A	15.0	14.4	20	20	18	30	22	25	20	32
		HIGH	NONE	—	—	8	15	7	30	9	15	9	32
			339A	10.0	9.6	14	15	13	30	17	20	15	32
			340A	15.0	14.4	20	20	18	30	23	25	20	32
			NONE	—	—	8	15	7	30	9	15	9	32

50GC**04 MCA MOCAP ELECTRICAL DATA — WITH FACTORY-INSTALLED HACR BREAKER (cont)

50GC UNIT SIZE	NOM. V-Ph-Hz	IFM TYPE	ELECTRIC HEATER			w/ POWERED CONVENIENCE OUTLET								
			CRHEATER ***A00	NOM (kW)	FLA	NO POWER EXHAUST				w/ POWER EXHAUST (powered from unit)				
						MCA	HACR BRKR	DISCONNECT SIZE		MCA	HACR BRKR	DISCONNECT SIZE		
								FLA	LRA			FLA	LRA	
**04	208/230-3-60	STD	NONE	—	—	25	30	24	87	27	30	27	89	
			323A	3.3/4.4	9.2/10.6	25/25	30/30	24/24	87/87	27/27	30/30	27/27	89/89	
			324A	4.9/6.5	13.6/15.6	30/30	30/30	25/27	87/87	33/33	35/35	27/30	89/89	
			325A	6.5/8.7	18.1/20.9	37/37	40/40	30/33	87/87	39/39	40/40	32/36	89/89	
			326A	7.9/10.5	21.9/25.3	42/42	45/45	35/39	87/87	45/45	45/45	37/41	89/89	
		328A	12.0/16.0	33.4/38.5	59/59	60/60	48/54	87/87	61/61	70/70	50/56	89/89		
		MED	NONE	—	—	26	30	26	89	28	35	29	91	
			323A	3.3/4.4	9.2/10.6	26/26	30/30	26/26	89/89	28/28	35/35	29/29	91/91	
			324A	4.9/6.5	13.6/15.6	32/32	35/35	27/29	89/89	35/35	35/35	29/32	91/91	
			325A	6.5/8.7	18.1/20.9	39/39	40/40	32/35	89/89	41/41	45/45	34/38	91/91	
			326A	7.9/10.5	21.9/25.3	44/44	45/45	37/40	89/89	47/47	50/50	39/43	91/91	
		328A	12.0/16.0	33.4/38.5	61/61	70/70	50/56	89/89	63/63	70/70	52/58	91/91		
		HIGH	NONE	—	—	29	35	29	92	30	40	31	94	
			323A	3.3/4.4	9.2/10.6	29/29	35/35	29/29	92/92	31/31	40/40	31/31	94/94	
			324A	4.9/6.5	13.6/15.6	35/35	35/35	30/32	92/92	37/37	40/40	32/34	94/94	
			325A	6.5/8.7	18.1/20.9	42/42	45/45	35/38	92/92	44/44	45/45	37/40	94/94	
			326A	7.9/10.5	21.9/25.3	47/47	50/50	39/43	92/92	50/50	50/50	41/45	94/94	
		328A	12.0/16.0	33.4/38.5	64/64	70/70	52/58	92/92	66/66	70/70	55/60	94/94		
	460-3-60	STD	NONE	—	—	11	15	11	43	12	15	12	44	
			333A	6.0	7.2	13	15	12	43	15	15	13	44	
			334A	8.8	10.6	18	20	16	43	19	20	17	44	
			335A	11.5	13.8	22	25	19	43	23	25	21	44	
			336A	14.0	16.8	25	25	23	43	27	30	24	44	
		MED	NONE	—	—	12	15	11	44	13	15	13	45	
			333A	6.0	7.2	14	15	12	44	15	15	13	45	
			334A	8.8	10.6	18	20	16	44	19	20	17	45	
			335A	11.5	13.8	22	25	20	44	23	25	21	45	
			336A	14.0	16.8	26	30	23	44	27	30	24	45	
		HIGH	NONE	—	—	12	15	12	44	13	15	13	45	
			333A	6.0	7.2	14	15	13	44	15	15	14	45	
			334A	8.8	10.6	18	20	16	44	20	20	18	45	
			335A	11.5	13.8	22	25	20	44	24	25	21	45	
			336A	14.0	16.8	26	30	24	44	27	30	25	45	
		575-3-60	STD	NONE	—	—	9	15	8	31	10	15	10	33
				339A	10.0	9.6	16	20	14	31	18	20	16	33
				340A	15.0	14.4	22	25	19	31	24	25	22	33
	MED		NONE	—	—	9	15	9	32	11	15	11	34	
			339A	10.0	9.6	16	20	14	32	18	20	16	34	
			340A	15.0	14.4	22	25	20	32	24	25	22	34	
	HIGH		NONE	—	—	9	15	9	32	11	15	11	34	
			339A	10.0	9.6	16	20	15	32	19	20	17	34	
			340A	15.0	14.4	22	25	20	32	25	25	22	34	

50GC**05 MCA MOCP ELECTRICAL DATA

50GC UNIT SIZE	NOM. V-Ph-Hz	IFM TYPE	ELECTRIC HEATER			NO CONVENIENCE OUTLET or UNPOWERED CONVENIENCE OUTLET							
			CRHEATER ***A00	NOM (kW)	FLA	NO POWER EXHAUST				w/ POWER EXHAUST (powered from unit)			
						MCA	FUSE OR HACR BRKR	DISCONNECT SIZE		MCA	FUSE OR HACR BRKR	DISCONNECT SIZE	
								FLA	LRA			FLA	LRA
**05	208/230-1-60	STD	NONE	—	—	32	50	31	133	34	50	33	135
			323A	3.3/4.4	15.9/18.3	32/32	50/50	31/31	133/133	34/34	50/50	33/33	135/135
			325A	6.5/8.7	31.4/36.3	46/52	50/60	42/47	133/133	48/54	50/60	44/50	135/135
			327A	9.8/13.0	46.9/54.2	65/74	70/80	60/68	133/133	68/77	70/80	62/70	135/135
			329A	13.1/17.4	62.8/72.5	85/97	90/100	78/89	133/133	88/100	90/100	80/91	135/135
			330A	14.4/19.2	69.3/80.0	93/107	100/110	85/98	133/133	96/109	100/110	88/100	135/135
		331A	15.8/21.0	75.8/87.5	101/116	110/125	93/106	133/133	104/118	110/125	95/109	135/135	
		MED	NONE	—	—	35	50	33	136	36	50	36	138
			323A	3.3/4.4	15.9/18.3	35/35	50/50	33/33	136/136	36/36	50/50	36/36	138/138
			325A	6.5/8.7	31.4/36.3	49/55	50/60	44/50	136/136	51/57	60/60	46/52	138/138
			327A	9.8/13.0	46.9/54.2	68/77	70/80	62/70	136/136	70/79	70/80	64/73	138/138
			329A	13.1/17.4	62.8/72.5	88/100	90/100	80/92	136/136	90/102	90/110	83/94	138/138
			330A	14.4/19.2	69.3/80.0	96/109	100/110	88/100	136/136	98/112	100/125	90/102	138/138
		331A	15.8/21.0	75.8/87.5	104/119	110/125	95/109	136/136	106/121	110/125	98/111	138/138	
		HIGH	NONE	—	—	36	50	35	138	38	50	37	140
			323A	3.3/4.4	15.9/18.3	36/36	50/50	35/35	138/138	38/38	50/50	37/37	140/140
			325A	6.5/8.7	31.4/36.3	51/57	60/60	46/52	138/138	53/59	60/60	48/54	140/140
			327A	9.8/13.0	46.9/54.2	70/79	70/80	64/72	138/138	72/82	80/90	66/75	140/140
	329A		13.1/17.4	62.8/72.5	90/102	90/110	82/93	138/138	92/104	100/110	85/96	140/140	
	330A		14.4/19.2	69.3/80.0	98/111	100/125	90/102	138/138	100/114	110/125	92/104	140/140	
	331A	15.8/21.0	75.8/87.5	106/121	110/125	97/111	138/138	109/123	110/125	99/113	140/140		
	208/230-3-60	STD	NONE	—	—	24	30	24	94	26	30	26	96
			323A	3.3/4.4	9.2/10.6	24/24	30/30	24/24	94/94	26/26	30/30	26/26	96/96
			324A	4.9/6.5	13.6/15.6	24/26	30/30	24/24	94/94	26/29	30/30	26/26	96/96
			325A	6.5/8.7	18.1/20.9	29/33	30/35	27/30	94/94	32/35	35/35	29/32	96/96
			328A	12.0/16.0	33.4/38.5	48/55	50/60	44/50	94/94	51/57	60/60	46/52	96/96
			330A	14.4/19.2	40.0/46.2	57/64	60/70	52/59	94/94	59/67	60/70	54/61	96/96
		331A	15.8/21.0	43.8/50.5	61/70	70/70	56/64	94/94	64/72	70/80	58/66	96/96	
		MED	NONE	—	—	27	30	26	97	28	40	28	99
			323A	3.3/4.4	9.2/10.6	27/27	30/30	26/26	97/97	28/28	40/40	28/28	99/99
			324A	4.9/6.5	13.6/15.6	27/29	30/30	26/26	97/97	29/31	40/40	28/28	99/99
			325A	6.5/8.7	18.1/20.9	32/35	40/40	29/32	97/97	34/38	40/40	31/34	99/99
			328A	12.0/16.0	33.4/38.5	51/57	60/60	47/52	97/97	53/60	60/60	49/55	99/99
			330A	14.4/19.2	40.0/46.2	59/67	60/70	54/61	97/97	62/69	70/70	56/63	99/99
		331A	15.8/21.0	43.8/50.5	64/72	70/80	59/66	97/97	66/75	70/80	61/68	99/99	
		HIGH	NONE	—	—	25	30	24	94	26	30	26	96
			323A	3.3/4.4	9.2/10.6	25/25	30/30	24/24	94/94	26/26	30/30	26/26	96/96
			324A	4.9/6.5	13.6/15.6	25/26	30/30	24/24	94/94	26/29	30/30	26/26	96/96
			325A	6.5/8.7	18.1/20.9	29/33	30/35	27/30	94/94	32/35	40/40	29/32	96/96
	328A		12.0/16.0	33.4/38.5	49/55	50/60	44/50	94/94	51/57	60/60	46/52	96/96	
	330A		14.4/19.2	40.0/46.2	57/65	60/70	52/59	94/94	59/67	60/70	54/61	96/96	
	331A	15.8/21.0	43.8/50.5	62/70	70/70	56/64	94/94	64/72	70/80	58/66	96/96		
460-3-60	STD	NONE	—	—	10	15	10	45	11	15	11	46	
		333A	6.0	7.2	11	15	10	45	12	15	11	46	
		335A	11.5	13.8	19	20	17	45	20	25	18	46	
		336A	14.0	16.8	23	25	21	45	24	25	22	46	
		337A	21.5	25.9	34	35	31	45	36	40	32	46	
	MED	NONE	—	—	11	15	10	45	12	15	11	46	
		333A	6.0	7.2	11	15	10	45	13	15	11	46	
		335A	11.5	13.8	20	20	18	45	21	25	19	46	
		336A	14.0	16.8	23	25	21	45	25	25	22	46	
		337A	21.5	25.9	35	35	32	45	36	40	33	46	
	HIGH	NONE	—	—	12	15	11	46	13	15	12	47	
		333A	6.0	7.2	12	15	11	46	14	15	12	47	
		335A	11.5	13.8	21	25	19	46	22	25	20	47	
		336A	14.0	16.8	24	25	22	46	26	30	23	47	
		337A	21.5	25.9	36	40	33	46	37	40	34	47	

Electrical data (cont)



50GC**05 MCA MOCP ELECTRICAL DATA (cont)

50GC UNIT SIZE	NOM. V-Ph-Hz	IFM TYPE	ELECTRIC HEATER			NO CONVENIENCE OUTLET or UNPOWERED CONVENIENCE OUTLET							
			CRHEATER ***A00	NOM (kW)	FLA	NO POWER EXHAUST				w/ POWER EXHAUST (powered from unit)			
						MCA	FUSE OR HACR BRKR	DISCONNECT SIZE		MCA	FUSE OR HACR BRKR	DISCONNECT SIZE	
FLA	LRA	FLA	LRA										
**05 (cont)	575-3-60	STD	NONE	—	—	8	15	7	37	10	15	9	39
			339A	10.0	9.6	14	15	12	37	16	20	14	39
			340A	15.0	14.4	20	20	18	37	22	25	20	39
		MED	NONE	—	—	8	15	8	37	10	15	10	39
			339A	10.0	9.6	14	15	13	37	17	20	15	39
			340A	15.0	14.4	20	20	18	37	23	25	20	39
	HIGH	NONE	—	—	9	15	8	38	11	15	11	40	
		339A	10.0	9.6	15	15	13	38	17	20	16	40	
		340A	15.0	14.4	21	25	19	38	23	25	21	40	

50GC**05 MCA MOCP ELECTRICAL DATA (cont)

50GC UNIT SIZE	NOM. V-Ph-Hz	IFM TYPE	ELECTRIC HEATER			w/ POWERED CONVENIENCE OUTLET								
			CRHEATER ***A00	NOM (kW)	FLA	NO POWER EXHAUST				w/ POWER EXHAUST (powered from unit)				
						MCA	FUSE OR HACR BRKR	DISCONNECT SIZE		MCA	FUSE OR HACR BRKR	DISCONNECT SIZE		
								FLA	LRA			FLA	LRA	
**05	208/230-3-60	STD	NONE	—	—	29	40	29	99	31	40	31	101	
			323A	3.3/4.4	9.2/10.6	29/29	40/40	29/29	99/99	31/31	40/40	31/31	101/101	
			324A	4.9/6.5	13.6/15.6	30/32	40/40	29/29	99/99	32/35	40/40	31/31	101/101	
			325A	6.5/8.7	18.1/20.9	35/39	40/40	32/35	99/99	38/41	40/45	34/37	101/101	
			328A	12.0/16.0	33.4/38.5	54/61	60/70	50/56	99/99	57/63	60/70	52/58	101/101	
			330A	14.4/19.2	40.0/46.2	63/70	70/80	57/64	99/99	65/73	70/80	59/67	101/101	
		331A	15.8/21.0	43.8/50.5	67/76	70/80	62/69	99/99	70/78	70/80	64/72	101/101		
		MED	NONE	—	—	31	40	32	102	33	45	34	104	
			323A	3.3/4.4	9.2/10.6	31/31	40/40	32/32	102/102	33/33	45/45	34/34	104/104	
			324A	4.9/6.5	13.6/15.6	32/35	40/40	32/32	102/102	35/37	45/45	34/34	104/104	
			325A	6.5/8.7	18.1/20.9	38/41	40/45	35/38	102/102	40/44	45/45	37/40	104/104	
			328A	12.0/16.0	33.4/38.5	57/63	60/70	52/58	102/102	59/66	60/70	54/60	104/104	
			330A	14.4/19.2	40.0/46.2	65/73	70/80	60/67	102/102	68/75	70/80	62/69	104/104	
		331A	15.8/21.0	43.8/50.5	70/78	70/80	64/72	102/102	72/81	80/90	66/74	104/104		
		HIGH	NONE	—	—	29	40	29	99	31	40	31	101	
			323A	3.3/4.4	9.2/10.6	29/29	40/40	29/29	99/99	31/31	40/40	31/31	101/101	
			324A	4.9/6.5	13.6/15.6	30/32	40/40	29/29	99/99	32/35	40/40	31/32	101/101	
			325A	6.5/8.7	18.1/20.9	35/39	40/40	32/35	99/99	38/41	40/45	34/38	101/101	
			328A	12.0/16.0	33.4/38.5	55/61	60/70	50/56	99/99	57/63	60/70	52/58	101/101	
			330A	14.4/19.2	40.0/46.2	63/71	70/80	57/65	99/99	65/73	70/80	60/67	101/101	
		331A	15.8/21.0	43.8/50.5	68/76	70/80	62/69	99/99	70/78	70/80	64/72	101/101		
		460-3-60	STD	NONE	—	—	13	15	12	47	14	15	13	48
				333A	6.0	7.2	14	15	12	47	15	15	13	48
				335A	11.5	13.8	22	25	20	47	23	25	21	48
	336A			14.0	16.8	26	30	23	47	27	30	24	48	
	337A			21.5	25.9	37	40	34	47	38	40	35	48	
	MED		NONE	—	—	13	15	13	47	14	20	14	48	
			333A	6.0	7.2	14	15	13	47	15	20	14	48	
335A			11.5	13.8	22	25	20	47	24	25	21	48		
336A			14.0	16.8	26	30	24	47	27	30	25	48		
337A			21.5	25.9	37	40	34	47	39	40	35	48		
HIGH	NONE		—	—	14	20	14	48	15	20	15	49		
	333A		6.0	7.2	15	20	14	48	16	20	15	49		
	335A		11.5	13.8	23	25	21	48	25	25	22	49		
	336A		14.0	16.8	27	30	25	48	28	30	26	49		
	337A		21.5	25.9	39	40	35	48	40	40	36	49		
575-3-60	STD		NONE	—	—	10	15	9	39	12	15	11	41	
			339A	10.0	9.6	16	20	14	39	18	20	16	41	
			340A	15.0	14.4	22	25	20	39	24	25	22	41	
	MED	NONE	—	—	10	15	10	39	12	15	12	41		
		339A	10.0	9.6	16	20	15	39	19	20	17	41		
		340A	15.0	14.4	22	25	20	39	25	25	22	41		
	HIGH	NONE	—	—	11	15	10	40	13	15	13	42		
		339A	10.0	9.6	17	20	15	40	20	20	18	42		
		340A	15.0	14.4	23	25	21	40	26	30	23	42		

50GC**05 MCA MOC P ELECTRICAL DATA — WITH FACTORY-INSTALLED HACR BREAKER

50GC UNIT SIZE	NOM. V-Ph-Hz	IFM TYPE	ELECTRIC HEATER			NO CONVENIENCE OUTLET or UNPOWERED CONVENIENCE OUTLET								
			CRHEATER ***A00	NOM (kW)	FLA	NO POWER EXHAUST				w/ POWER EXHAUST (powered from unit)				
						MCA	HACR BRKR	DISCONNECT SIZE		MCA	HACR BRKR	DISCONNECT SIZE		
								FLA	LRA			FLA	LRA	
**05	208/230-1-60	STD	NONE	—	—	32	50	31	133	34	50	33	135	
			323A	3.3/4.4	15.9/18.3	32/32	50/50	31/31	133/133	34/34	50/50	33/33	135/135	
			325A	6.5/8.7	31.4/36.3	52/52	60/60	42/47	133/133	54/54	60/60	44/50	135/135	
			327A	9.8/13.0	46.9/54.2	74/74	80/80	60/68	133/133	77/77	80/80	62/70	135/135	
			329A	13.1/17.4	62.8/72.5	97/97	100/100	78/89	133/133	100/100	100/100	80/91	135/135	
			330A	14.4/19.2	69.3/80.0	107/107	110/110	85/98	133/133	109/109	110/110	88/100	135/135	
		331A	15.8/21.0	75.8/87.5	116/116	125/125	93/106	133/133	118/118	125/125	95/109	135/135		
		MED	NONE	—	—	35	50	33	136	36	50	36	138	
			323A	3.3/4.4	15.9/18.3	35/35	50/50	33/33	136/136	36/36	50/50	36/36	138/138	
			325A	6.5/8.7	31.4/36.3	55/55	60/60	44/50	136/136	57/57	60/60	46/52	138/138	
			327A	9.8/13.0	46.9/54.2	77/77	80/80	62/70	136/136	79/79	80/80	64/73	138/138	
			329A	13.1/17.4	62.8/72.5	100/100	100/100	80/92	136/136	102/102	110/110	83/94	138/138	
			330A	14.4/19.2	69.3/80.0	109/109	110/110	88/100	136/136	112/112	125/125	90/102	138/138	
		331A	15.8/21.0	75.8/87.5	119/119	125/125	95/109	136/136	121/121	125/125	98/111	138/138		
		HIGH	NONE	—	—	36	50	35	138	38	50	37	140	
			323A	3.3/4.4	15.9/18.3	36/36	50/50	35/35	138/138	38/38	50/50	37/37	140/140	
			325A	6.5/8.7	31.4/36.3	57/57	60/60	46/52	138/138	59/59	60/60	48/54	140/140	
			327A	9.8/13.0	46.9/54.2	79/79	80/80	64/72	138/138	82/82	90/90	66/75	140/140	
			329A	13.1/17.4	62.8/72.5	102/102	110/110	82/93	138/138	104/104	110/110	85/96	140/140	
			330A	14.4/19.2	69.3/80.0	111/111	125/125	90/102	138/138	114/114	125/125	92/104	140/140	
		331A	15.8/21.0	75.8/87.5	121/121	125/125	97/111	138/138	123/123	125/125	99/113	140/140		
		208/230-3-60	STD	NONE	—	—	24	30	24	94	26	30	26	96
				323A	3.3/4.4	9.2/10.6	24/24	30/30	24/24	94/94	26/26	30/30	26/26	96/96
				324A	4.9/6.5	13.6/15.6	26/26	30/30	24/24	94/94	29/29	30/30	26/26	96/96
	325A			6.5/8.7	18.1/20.9	33/33	35/35	27/30	94/94	35/35	35/35	29/32	96/96	
	328A			12.0/16.0	33.4/38.5	55/55	60/60	44/50	94/94	57/57	60/60	46/52	96/96	
	330A			14.4/19.2	40.0/46.2	64/64	70/70	52/59	94/94	67/67	70/70	54/61	96/96	
	331A		15.8/21.0	43.8/50.5	70/70	70/70	56/64	94/94	72/72	80/80	58/66	96/96		
	MED		NONE	—	—	27	30	26	97	28	40	28	99	
			323A	3.3/4.4	9.2/10.6	27/27	30/30	26/26	97/97	28/28	40/40	28/28	99/99	
			324A	4.9/6.5	13.6/15.6	29/29	30/30	26/26	97/97	31/31	40/40	28/28	99/99	
			325A	6.5/8.7	18.1/20.9	35/35	40/40	29/32	97/97	38/38	40/40	31/34	99/99	
			328A	12.0/16.0	33.4/38.5	57/57	60/60	47/52	97/97	60/60	60/60	49/55	99/99	
			330A	14.4/19.2	40.0/46.2	67/67	70/70	54/61	97/97	69/69	70/70	56/63	99/99	
	331A		15.8/21.0	43.8/50.5	72/72	80/80	59/66	97/97	75/75	80/80	61/68	99/99		
	HIGH		NONE	—	—	25	30	24	94	26	30	26	96	
323A			3.3/4.4	9.2/10.6	25/25	30/30	24/24	94/94	26/26	30/30	26/26	96/96		
324A			4.9/6.5	13.6/15.6	26/26	30/30	24/24	94/94	29/29	30/30	26/26	96/96		
325A			6.5/8.7	18.1/20.9	33/33	35/35	27/30	94/94	35/35	40/40	29/32	96/96		
328A			12.0/16.0	33.4/38.5	55/55	60/60	44/50	94/94	57/57	60/60	46/52	96/96		
330A			14.4/19.2	40.0/46.2	65/65	70/70	52/59	94/94	67/67	70/70	54/61	96/96		
331A	15.8/21.0		43.8/50.5	70/70	70/70	56/64	94/94	72/72	80/80	58/66	96/96			
460-3-60	STD		NONE	—	—	10	15	10	45	11	15	11	46	
			333A	6.0	7.2	11	15	10	45	12	15	11	46	
			335A	11.5	13.8	19	20	17	45	20	25	18	46	
		336A	14.0	16.8	23	25	21	45	24	25	22	46		
		337A	21.5	25.9	34	35	31	45	36	40	32	46		
	MED	NONE	—	—	11	15	10	45	12	15	11	46		
		333A	6.0	7.2	11	15	10	45	13	15	11	46		
		335A	11.5	13.8	20	20	18	45	21	25	19	46		
		336A	14.0	16.8	23	25	21	45	25	25	22	46		
		337A	21.5	25.9	35	35	32	45	36	40	33	46		
	HIGH	NONE	—	—	12	15	11	46	13	15	12	47		
		333A	6.0	7.2	12	15	11	46	14	15	12	47		
335A		11.5	13.8	21	25	19	46	22	25	20	47			
336A		14.0	16.8	24	25	22	46	26	30	23	47			
337A	21.5	25.9	36	40	33	46	37	40	34	47				

Electrical data (cont)



50GC**05 MCA MOCP ELECTRICAL DATA — WITH FACTORY-INSTALLED HACR BREAKER (cont)

50GC UNIT SIZE	NOM. V-Ph-Hz	IFM TYPE	ELECTRIC HEATER			NO CONVENIENCE OUTLET or UNPOWERED CONVENIENCE OUTLET							
			CRHEATER ***A00	NOM (kW)	FLA	NO POWER EXHAUST				w/ POWER EXHAUST (powered from unit)			
						MCA	HACR BRKR	DISCONNECT SIZE		MCA	HACR BRKR	DISCONNECT SIZE	
FLA	LRA	FLA	LRA										
**05 (cont)	575-3-60	STD	NONE	—	—	8	15	7	37	10	15	9	39
			339A	10.0	9.6	14	15	12	37	16	20	14	39
			340A	15.0	14.4	20	20	18	37	22	25	20	39
		MED	NONE	—	—	8	15	8	37	10	15	10	39
			339A	10.0	9.6	14	15	13	37	17	20	15	39
			340A	15.0	14.4	20	20	18	37	23	25	20	39
		HIGH	NONE	—	—	9	15	8	38	11	15	11	40
			339A	10.0	9.6	15	15	13	38	17	20	16	40
			340A	15.0	14.4	21	25	19	38	23	25	21	40

50GC**05 MCA MOCAP ELECTRICAL DATA — WITH FACTORY-INSTALLED HACR BREAKER (cont)

50GC UNIT SIZE	NOM. V-Ph-Hz	IFM TYPE	ELECTRIC HEATER			w/ POWERED CONVENIENCE OUTLET								
			CRHEATER ***A00	NOM (kW)	FLA	NO POWER EXHAUST				w/ POWER EXHAUST (powered from unit)				
						MCA	HACR BRKR	DISCONNECT SIZE		MCA	HACR BRKR	DISCONNECT SIZE		
								FLA	LRA			FLA	LRA	
**05	208/230-3-60	STD	NONE	—	—	29	40	29	99	31	40	31	101	
			323A	3.3/4.4	9.2/10.6	29/29	40/40	29/29	99/99	31/31	40/40	31/31	101/101	
			324A	4.9/6.5	13.6/15.6	32/32	40/40	29/29	99/99	35/35	40/40	31/31	101/101	
			325A	6.5/8.7	18.1/20.9	39/39	40/40	32/35	99/99	41/41	45/45	34/37	101/101	
			328A	12.0/16.0	33.4/38.5	61/61	70/70	50/56	99/99	63/63	70/70	52/58	101/101	
			330A	14.4/19.2	40.0/46.2	70/70	80/80	57/64	99/99	73/73	80/80	59/67	101/101	
		331A	15.8/21.0	43.8/50.5	76/76	80/80	62/69	99/99	78/78	80/80	64/72	101/101		
		MED	NONE	—	—	31	40	32	102	33	45	34	104	
			323A	3.3/4.4	9.2/10.6	31/31	40/40	32/32	102/102	33/33	45/45	34/34	104/104	
			324A	4.9/6.5	13.6/15.6	35/35	40/40	32/32	102/102	37/37	45/45	34/34	104/104	
			325A	6.5/8.7	18.1/20.9	41/41	45/45	35/38	102/102	44/44	45/45	37/40	104/104	
			328A	12.0/16.0	33.4/38.5	63/63	70/70	52/58	102/102	66/66	70/70	54/60	104/104	
			330A	14.4/19.2	40.0/46.2	73/73	80/80	60/67	102/102	75/75	80/80	62/69	104/104	
		331A	15.8/21.0	43.8/50.5	78/78	80/80	64/72	102/102	81/81	90/90	66/74	104/104		
		HIGH	NONE	—	—	29	40	29	99	31	40	31	101	
			323A	3.3/4.4	9.2/10.6	29/29	40/40	29/29	99/99	31/31	40/40	31/31	101/101	
			324A	4.9/6.5	13.6/15.6	32/32	40/40	29/29	99/99	35/35	40/40	31/32	101/101	
			325A	6.5/8.7	18.1/20.9	39/39	40/40	32/35	99/99	41/41	45/45	34/38	101/101	
			328A	12.0/16.0	33.4/38.5	61/61	70/70	50/56	99/99	63/63	70/70	52/58	101/101	
			330A	14.4/19.2	40.0/46.2	71/71	80/80	57/65	99/99	73/73	80/80	60/67	101/101	
		331A	15.8/21.0	43.8/50.5	76/76	80/80	62/69	99/99	78/78	80/80	64/72	101/101		
		460-3-60	STD	NONE	—	—	13	15	12	47	14	15	13	48
				333A	6.0	7.2	14	15	12	47	15	15	13	48
				335A	11.5	13.8	22	25	20	47	23	25	21	48
	336A			14.0	16.8	26	30	23	47	27	30	24	48	
	337A			21.5	25.9	37	40	34	47	38	40	35	48	
	MED		NONE	—	—	13	15	13	47	14	20	14	48	
			333A	6.0	7.2	14	15	13	47	15	20	14	48	
			335A	11.5	13.8	22	25	20	47	24	25	21	48	
			336A	14.0	16.8	26	30	24	47	27	30	25	48	
			337A	21.5	25.9	37	40	34	47	39	40	35	48	
	HIGH		NONE	—	—	14	20	14	48	15	20	15	49	
			333A	6.0	7.2	15	20	14	48	16	20	15	49	
			335A	11.5	13.8	23	25	21	48	25	25	22	49	
			336A	14.0	16.8	27	30	25	48	28	30	26	49	
			337A	21.5	25.9	39	40	35	48	40	40	36	49	
575-3-60	STD		NONE	—	—	10	15	9	39	12	15	11	41	
			339A	10.0	9.6	16	20	14	39	18	20	16	41	
			340A	15.0	14.4	22	25	20	39	24	25	22	41	
	MED	NONE	—	—	10	15	10	39	12	15	12	41		
		339A	10.0	9.6	16	20	15	39	19	20	17	41		
		340A	15.0	14.4	22	25	20	39	25	25	22	41		
	HIGH	NONE	—	—	11	15	10	40	13	15	13	42		
		339A	10.0	9.6	17	20	15	40	20	20	18	42		
		340A	15.0	14.4	23	25	21	40	26	30	23	42		

50GC**06 MCA MOCP ELECTRICAL DATA

50GC UNIT SIZE	NOM. V-Ph-Hz	IFM TYPE	ELECTRIC HEATER			NO CONVENIENCE OUTLET or UNPOWERED CONVENIENCE OUTLET							
			CRHEATER ***A00	NOM (kW)	FLA	NO POWER EXHAUST				w/ POWER EXHAUST (powered from unit)			
						MCA	FUSE OR HACR BRKR	DISCONNECT SIZE		MCA	FUSE OR HACR BRKR	DISCONNECT SIZE	
								FLA	LRA			FLA	LRA
**06	208/230-1-60	STD	NONE	—	—	38	60	36	161	40	60	39	163
			324A	4.9/6.5	23.5/27.1	39/43	60/60	36/39	161/161	41/46	60/60	39/42	163/163
			325A	6.5/8.7	31.4/36.3	49/55	60/60	44/50	161/161	51/57	60/60	47/52	163/163
			327A	9.8/13.0	46.9/54.2	68/77	70/80	62/71	161/161	70/80	80/80	64/73	163/163
			329A	13.1/17.4	62.8/72.5	88/100	90/100	81/92	161/161	90/102	90/110	83/94	163/163
		331A	15.8/21.0	75.8/87.5	104/119	110/125	95/109	161/161	107/121	110/125	98/111	163/163	
		MED	NONE	—	—	39	60	38	163	41	60	40	165
			324A	4.9/6.5	23.5/27.1	41/45	60/60	38/41	163/163	43/47	60/60	40/43	165/165
			325A	6.5/8.7	31.4/36.3	50/57	60/60	46/52	163/163	53/59	60/60	48/54	165/165
			327A	9.8/13.0	46.9/54.2	70/79	70/80	64/72	163/163	72/81	80/90	66/74	165/165
	329A		13.1/17.4	62.8/72.5	90/102	90/110	82/93	163/163	92/104	100/110	84/95	165/165	
	331A	15.8/21.0	75.8/87.5	106/121	110/125	97/111	163/163	108/123	110/125	99/113	165/165		
	208/230-3-60	STD	NONE	—	—	29	45	29	124	31	45	31	126
			324A	4.9/6.5	13.6/15.6	29/29	45/45	29/29	124/124	31/31	45/45	31/31	126/126
			326A	7.9/10.5	21.9/25.3	37/41	45/45	33/37	124/124	39/43	45/45	36/40	126/126
			328A	12.0/16.0	33.4/38.5	51/58	60/60	47/53	124/124	54/60	60/60	49/55	126/126
			331A	15.8/21.0	43.8/50.5	64/73	70/80	59/66	124/124	67/75	70/80	61/69	126/126
			332A	18.4/24.5	51.1/58.9	73/83	80/90	67/76	124/124	76/85	80/90	69/78	126/126
		MED	NONE	—	—	31	45	30	126	33	45	32	128
			324A	4.9/6.5	13.6/15.6	31/31	45/45	30/30	126/126	33/33	45/45	32/32	128/128
			326A	7.9/10.5	21.9/25.3	39/43	45/45	35/39	126/126	41/45	45/45	37/41	128/128
			328A	12.0/16.0	33.4/38.5	53/59	60/60	48/54	126/126	55/62	60/70	50/56	128/128
			331A	15.8/21.0	43.8/50.5	66/74	70/80	60/68	126/126	68/77	70/80	62/70	128/128
			332A	18.4/24.5	51.1/58.9	75/85	80/90	69/78	126/126	77/87	80/90	71/80	128/128
		HIGH	NONE	—	—	29	40	28	123	31	45	30	125
			324A	4.9/6.5	13.6/15.6	29/29	40/40	28/28	123/123	31/31	45/45	30/30	125/125
			326A	7.9/10.5	21.9/25.3	36/40	40/40	33/36	123/123	38/42	45/45	35/39	125/125
			328A	12.0/16.0	33.4/38.5	50/57	50/60	46/52	123/123	53/59	60/60	48/54	125/125
			331A	15.8/21.0	43.8/50.5	63/72	70/80	58/65	123/123	66/74	70/80	60/68	125/125
			332A	18.4/24.5	51.1/58.9	72/82	80/90	66/75	123/123	75/84	80/90	68/77	125/125
	460-3-60	STD	NONE	—	—	12	15	11	56	13	20	13	57
			333A	6.0	7.2	12	15	11	56	13	20	13	57
			335A	11.5	13.8	20	20	18	56	21	25	19	57
			336A	14.0	16.8	23	25	21	56	25	25	22	57
			337A	21.5	25.9	35	35	32	56	36	40	33	57
			338A	24.0	28.9	38	40	35	56	40	40	36	57
		MED	NONE	—	—	13	15	12	57	14	20	13	58
			333A	6.0	7.2	13	15	12	57	14	20	13	58
			335A	11.5	13.8	20	20	18	57	21	25	19	58
			336A	14.0	16.8	24	25	22	57	25	25	23	58
			337A	21.5	25.9	35	35	32	57	36	40	33	58
			338A	24.0	28.9	39	40	35	57	40	40	37	58
		HIGH	NONE	—	—	14	20	13	58	15	20	14	59
			333A	6.0	7.2	14	20	13	58	15	20	14	59
			335A	11.5	13.8	21	25	19	58	23	25	20	59
			336A	14.0	16.8	25	25	23	58	26	30	24	59
			337A	21.5	25.9	36	40	33	58	38	40	34	59
			338A	24.0	28.9	40	40	37	58	41	45	38	59
	575-3-60	STD	NONE	—	—	9	15	9	43	11	15	11	45
			340A	15.0	14.4	20	20	18	43	23	25	20	45
			341A	21.0	20.2	28	30	25	43	30	30	27	45
		MED	NONE	—	—	9	15	9	44	11	15	11	46
			340A	15.0	14.4	21	25	19	44	23	25	21	46
			341A	21.0	20.2	28	30	25	44	30	30	27	46
	HIGH	NONE	—	—	10	15	10	45	12	15	12	47	
		340A	15.0	14.4	22	25	19	45	24	25	22	47	
		341A	21.0	20.2	29	30	26	45	31	35	28	47	

50GC**06 MCA MOCP ELECTRICAL DATA (cont)

50GC UNIT SIZE	NOM. V-Ph-Hz	IFM TYPE	ELECTRIC HEATER			w/ POWERED CONVENIENCE OUTLET							
			CRHEATER ***A00	NOM (kW)	FLA	NO POWER EXHAUST				w/ POWER EXHAUST (powered from unit)			
						MCA	FUSE OR HACR BRKR	DISCONNECT SIZE		MCA	FUSE OR HACR BRKR	DISCONNECT SIZE	
								FLA	LRA			FLA	LRA
**06	208/230-3-60	STD	NONE	—	—	34	45	34	129	36	50	36	131
			324A	4.9/6.5	13.6/15.6	34/35	45/45	34/34	129/129	36/37	50/50	36/36	131/131
			326A	7.9/10.5	21.9/25.3	43/47	45/50	39/43	129/129	45/49	50/50	41/45	131/131
			328A	12.0/16.0	33.4/38.5	57/64	60/70	52/58	129/129	60/66	60/70	54/60	131/131
			331A	15.8/21.0	43.8/50.5	70/79	70/80	64/72	129/129	73/81	80/90	66/74	131/131
		332A	18.4/24.5	51.1/58.9	79/89	80/90	73/82	129/129	82/91	90/100	75/84	131/131	
		MED	NONE	—	—	36	50	36	131	38	50	38	133
			324A	4.9/6.5	13.6/15.6	36/37	50/50	36/36	131/131	38/39	50/50	38/38	133/133
			326A	7.9/10.5	21.9/25.3	45/49	50/50	41/45	131/131	47/51	50/60	43/47	133/133
			328A	12.0/16.0	33.4/38.5	59/65	60/70	54/60	131/131	61/68	70/70	56/62	133/133
			331A	15.8/21.0	43.8/50.5	72/80	80/80	66/73	131/131	74/83	80/90	68/76	133/133
		332A	18.4/24.5	51.1/58.9	81/91	90/100	74/83	131/131	83/93	90/100	76/85	133/133	
		HIGH	NONE	—	—	33	45	33	128	35	50	35	130
			324A	4.9/6.5	13.6/15.6	33/34	45/45	33/33	128/128	35/36	50/50	35/35	130/130
			326A	7.9/10.5	21.9/25.3	42/46	45/50	38/42	128/128	44/48	50/50	40/44	130/130
	328A		12.0/16.0	33.4/38.5	56/63	60/70	51/57	128/128	59/65	60/70	53/59	130/130	
	331A		15.8/21.0	43.8/50.5	69/78	70/80	63/71	128/128	72/80	80/80	65/73	130/130	
	332A	18.4/24.5	51.1/58.9	78/88	80/90	72/81	128/128	81/90	90/100	74/83	130/130		
	460-3-60	STD	NONE	—	—	14	20	14	58	15	20	15	59
			333A	6.0	7.2	14	20	14	58	15	20	15	59
			335A	11.5	13.8	22	25	20	58	24	25	21	59
			336A	14.0	16.8	26	30	24	58	27	30	25	59
			337A	21.5	25.9	37	40	34	58	39	40	35	59
		338A	24.0	28.9	41	45	37	58	42	45	39	59	
		MED	NONE	—	—	15	20	14	59	16	20	16	60
			333A	6.0	7.2	15	20	14	59	16	20	16	60
			335A	11.5	13.8	23	25	21	59	24	25	22	60
			336A	14.0	16.8	27	30	24	59	28	30	25	60
			337A	21.5	25.9	38	40	35	59	39	40	36	60
		338A	24.0	28.9	42	45	38	59	43	45	39	60	
		HIGH	NONE	—	—	16	20	16	60	17	20	17	61
			333A	6.0	7.2	16	20	16	60	17	20	17	61
			335A	11.5	13.8	24	25	22	60	25	25	23	61
	336A		14.0	16.8	28	30	25	60	29	30	26	61	
	337A		21.5	25.9	39	40	36	60	40	45	37	61	
	338A	24.0	28.9	43	45	39	60	44	45	40	61		
575-3-60	STD	NONE	—	—	11	15	10	45	13	15	13	47	
		340A	15.0	14.4	22	25	20	45	25	25	22	47	
		341A	21.0	20.2	30	30	27	45	32	35	29	47	
	MED	NONE	—	—	11	15	11	46	13	15	13	48	
		340A	15.0	14.4	23	25	21	46	25	25	23	48	
	341A	21.0	20.2	30	30	27	46	32	35	29	48		
	HIGH	NONE	—	—	12	15	12	47	14	15	14	49	
340A		15.0	14.4	24	25	21	47	26	30	24	49		
341A	21.0	20.2	31	35	28	47	33	35	30	49			

50GC**06 MCA MOC P ELECTRICAL DATA — WITH FACTORY-INSTALLED HACR BREAKER

50GC UNIT SIZE	NOM. V-Ph-Hz	IFM TYPE	ELECTRIC HEATER			NO CONVENIENCE OUTLET or UNPOWERED CONVENIENCE OUTLET							
			CRHEATER ***A00	NOM (kW)	FLA	NO POWER EXHAUST				w/ POWER EXHAUST (powered from unit)			
						MCA	HACR BRKR	DISCONNECT SIZE		MCA	HACR BRKR	DISCONNECT SIZE	
								FLA	LRA			FLA	LRA
**06	208/230-1-60	STD	NONE	—	—	38	60	36	161	40	60	39	163
			324A	4.9/6.5	23.5/27.1	43/43	60/60	36/39	161/161	46/46	60/60	39/42	163/163
			325A	6.5/8.7	31.4/36.3	55/55	60/60	44/50	161/161	57/57	60/60	47/52	163/163
			327A	9.8/13.0	46.9/54.2	77/77	80/80	62/71	161/161	80/80	80/80	64/73	163/163
			329A	13.1/17.4	62.8/72.5	100/100	100/100	81/92	161/161	102/102	110/110	83/94	163/163
		331A	15.8/21.0	75.8/87.5	119/119	125/125	95/109	161/161	121/121	125/125	98/111	163/163	
		MED	NONE	—	—	39	60	38	163	41	60	40	165
			324A	4.9/6.5	23.5/27.1	45/45	60/60	38/41	163/163	47/47	60/60	40/43	165/165
			325A	6.5/8.7	31.4/36.3	57/57	60/60	46/52	163/163	59/59	60/60	48/54	165/165
			327A	9.8/13.0	46.9/54.2	79/79	80/80	64/72	163/163	81/81	90/90	66/74	165/165
	329A		13.1/17.4	62.8/72.5	102/102	110/110	82/93	163/163	104/104	110/110	84/95	165/165	
	331A	15.8/21.0	75.8/87.5	121/121	125/125	97/111	163/163	123/123	125/125	99/113	165/165		
	208/230-3-60	STD	NONE	—	—	29	45	29	124	31	45	31	126
			324A	4.9/6.5	13.6/15.6	29/29	45/45	29/29	124/124	31/31	45/45	31/31	126/126
			326A	7.9/10.5	21.9/25.3	41/41	45/45	33/37	124/124	43/43	45/45	36/40	126/126
			328A	12.0/16.0	33.4/38.5	58/58	60/60	47/53	124/124	60/60	60/60	49/55	126/126
			331A	15.8/21.0	43.8/50.5	73/73	80/80	59/66	124/124	75/75	80/80	61/69	126/126
			332A	18.4/24.5	51.1/58.9	83/83	90/90	67/76	124/124	85/85	90/90	69/78	126/126
		MED	NONE	—	—	31	45	30	126	33	45	32	128
			324A	4.9/6.5	13.6/15.6	31/31	45/45	30/30	126/126	33/33	45/45	32/32	128/128
			326A	7.9/10.5	21.9/25.3	43/43	45/45	35/39	126/126	45/45	45/45	37/41	128/128
			328A	12.0/16.0	33.4/38.5	59/59	60/60	48/54	126/126	62/62	70/70	50/56	128/128
			331A	15.8/21.0	43.8/50.5	74/74	80/80	60/68	126/126	77/77	80/80	62/70	128/128
			332A	18.4/24.5	51.1/58.9	85/85	90/90	69/78	126/126	87/87	90/90	71/80	128/128
		HIGH	NONE	—	—	29	40	28	123	31	45	30	125
			324A	4.9/6.5	13.6/15.6	29/29	40/40	28/28	123/123	31/31	45/45	30/30	125/125
			326A	7.9/10.5	21.9/25.3	40/40	40/40	33/36	123/123	42/42	45/45	35/39	125/125
			328A	12.0/16.0	33.4/38.5	57/57	60/60	46/52	123/123	59/59	60/60	48/54	125/125
			331A	15.8/21.0	43.8/50.5	72/72	80/80	58/65	123/123	74/74	80/80	60/68	125/125
			332A	18.4/24.5	51.1/58.9	82/82	90/90	66/75	123/123	84/84	90/90	68/77	125/125
	460-3-60	STD	NONE	—	—	12	15	11	56	13	20	13	57
			333A	6.0	7.2	12	15	11	56	13	20	13	57
			335A	11.5	13.8	20	20	18	56	21	25	19	57
			336A	14.0	16.8	23	25	21	56	25	25	22	57
			337A	21.5	25.9	35	35	32	56	36	40	33	57
			338A	24.0	28.9	38	40	35	56	40	40	36	57
		MED	NONE	—	—	13	15	12	57	14	20	13	58
			333A	6.0	7.2	13	15	12	57	14	20	13	58
			335A	11.5	13.8	20	20	18	57	21	25	19	58
			336A	14.0	16.8	24	25	22	57	25	25	23	58
			337A	21.5	25.9	35	35	32	57	36	40	33	58
			338A	24.0	28.9	39	40	35	57	40	40	37	58
		HIGH	NONE	—	—	14	20	13	58	15	20	14	59
			333A	6.0	7.2	14	20	13	58	15	20	14	59
			335A	11.5	13.8	21	25	19	58	23	25	20	59
			336A	14.0	16.8	25	25	23	58	26	30	24	59
			337A	21.5	25.9	36	40	33	58	38	40	34	59
			338A	24.0	28.9	40	40	37	58	41	45	38	59
	575-3-60	STD	NONE	—	—	9	15	9	43	11	15	11	45
			340A	15.0	14.4	20	20	18	43	23	25	20	45
			341A	21.0	20.2	28	30	25	43	30	30	27	45
		MED	NONE	—	—	9	15	9	44	11	15	11	46
			340A	15.0	14.4	21	25	19	44	23	25	21	46
			341A	21.0	20.2	28	30	25	44	30	30	27	46
		HIGH	NONE	—	—	10	15	10	45	12	15	12	47
			340A	15.0	14.4	22	25	19	45	24	25	22	47
			341A	21.0	20.2	29	30	26	45	31	35	28	47

50GC**06 MCA MOCP ELECTRICAL DATA — WITH FACTORY-INSTALLED HACR BREAKER (cont)

50GC UNIT SIZE	NOM. V-Ph-Hz	IFM TYPE	ELECTRIC HEATER			w/ POWERED CONVENIENCE OUTLET							
			CRHEATER ***A00	NOM (kW)	FLA	NO POWER EXHAUST				w/ POWER EXHAUST (powered from unit)			
						MCA	HACR BRKR	DISCONNECT SIZE		MCA	HACR BRKR	DISCONNECT SIZE	
								FLA	LRA			FLA	LRA
**06	208/230-3-60	STD	NONE	—	—	34	45	34	129	36	50	36	131
			324A	4.9/6.5	13.6/15.6	35/35	45/45	34/34	129/129	37/37	50/50	36/36	131/131
			326A	7.9/10.5	21.9/25.3	47/47	50/50	39/43	129/129	49/49	50/50	41/45	131/131
			328A	12.0/16.0	33.4/38.5	64/64	70/70	52/58	129/129	66/66	70/70	54/60	131/131
			331A	15.8/21.0	43.8/50.5	79/79	80/80	64/72	129/129	81/81	90/90	66/74	131/131
		332A	18.4/24.5	51.1/58.9	89/89	90/90	73/82	129/129	91/91	100/100	75/84	131/131	
		MED	NONE	—	—	36	50	36	131	38	50	38	133
			324A	4.9/6.5	13.6/15.6	37/37	50/50	36/36	131/131	39/39	50/50	38/38	133/133
			326A	7.9/10.5	21.9/25.3	49/49	50/50	41/45	131/131	51/51	60/60	43/47	133/133
			328A	12.0/16.0	33.4/38.5	65/65	70/70	54/60	131/131	68/68	70/70	56/62	133/133
			331A	15.8/21.0	43.8/50.5	80/80	80/80	66/73	131/131	83/83	90/90	68/76	133/133
		332A	18.4/24.5	51.1/58.9	91/91	100/100	74/83	131/131	93/93	100/100	76/85	133/133	
		HIGH	NONE	—	—	33	45	33	128	35	50	35	130
			324A	4.9/6.5	13.6/15.6	34/34	45/45	33/33	128/128	36/36	50/50	35/35	130/130
			326A	7.9/10.5	21.9/25.3	46/46	50/50	38/42	128/128	48/48	50/50	40/44	130/130
	328A		12.0/16.0	33.4/38.5	63/63	70/70	51/57	128/128	65/65	70/70	53/59	130/130	
	331A		15.8/21.0	43.8/50.5	78/78	80/80	63/71	128/128	80/80	80/80	65/73	130/130	
	332A	18.4/24.5	51.1/58.9	88/88	90/90	72/81	128/128	90/90	100/100	74/83	130/130		
	460-3-60	STD	NONE	—	—	14	20	14	58	15	20	15	59
			333A	6.0	7.2	14	20	14	58	15	20	15	59
			335A	11.5	13.8	22	25	20	58	24	25	21	59
			336A	14.0	16.8	26	30	24	58	27	30	25	59
			337A	21.5	25.9	37	40	34	58	39	40	35	59
		338A	24.0	28.9	41	45	37	58	42	45	39	59	
		MED	NONE	—	—	15	20	14	59	16	20	16	60
			333A	6.0	7.2	15	20	14	59	16	20	16	60
			335A	11.5	13.8	23	25	21	59	24	25	22	60
			336A	14.0	16.8	27	30	24	59	28	30	25	60
			337A	21.5	25.9	38	40	35	59	39	40	36	60
		338A	24.0	28.9	42	45	38	59	43	45	39	60	
		HIGH	NONE	—	—	16	20	16	60	17	20	17	61
			333A	6.0	7.2	16	20	16	60	17	20	17	61
			335A	11.5	13.8	24	25	22	60	25	25	23	61
	336A		14.0	16.8	28	30	25	60	29	30	26	61	
	337A		21.5	25.9	39	40	36	60	40	45	37	61	
	338A	24.0	28.9	43	45	39	60	44	45	40	61		
575-3-60	STD	NONE	—	—	11	15	10	45	13	15	13	47	
		340A	15.0	14.4	22	25	20	45	25	25	22	47	
		341A	21.0	20.2	30	30	27	45	32	35	29	47	
	MED	NONE	—	—	11	15	11	46	13	15	13	48	
		340A	15.0	14.4	23	25	21	46	25	25	23	48	
		341A	21.0	20.2	30	30	27	46	32	35	29	48	
	HIGH	NONE	—	—	12	15	12	47	14	15	14	49	
		340A	15.0	14.4	24	25	21	47	26	30	24	49	
		341A	21.0	20.2	31	35	28	47	33	35	30	49	

50GC**04 ELECTRIC HEAT DATA — WITHOUT NON-FUSED DISCONNECT

50GC UNIT SIZE	NOM. V-Ph-Hz	IFM TYPE	ELECTRIC HEATER PART NUMBER	NOM (kW)	APPLICATION (kW)	APPLICATION OUTPUT (MBH)	SINGLE POINT OR JUNCTION PART NUMBER CRSINGLEXXXA00			
							NO C.O. OR UNPOWERED C.O.		w/PWRD C.O.	
							NO P.E.	w/P.E. (pwrd fr/unit)	NO P.E.	w/P.E. (pwrd fr/unit)
**04	208/230-1-60	STD	CRHEATER323A00	4.4	3.3/4.0	11.3/13.8	—	—	—	—
			CRHEATER324A00	6.5	4.9/6.0	16.7/20.4	—	—	—	—
			CRHEATER325A00	8.7	6.5/8.0	22.3/27.3	—	037	—	—
			CRHEATER326A00	10.5	7.9/9.6	26.9/32.9	037	040	—	—
			CRHEATER327A00	13.0	9.8/11.9	33.3/40.7	040	040	—	—
		MED	CRHEATER323A00	4.4	3.3/4.0	11.3/13.8	—	—	—	—
			CRHEATER324A00	6.5	4.9/6.0	16.7/20.4	—	—	—	—
			CRHEATER325A00	8.7	6.5/8.0	22.3/27.3	037	037	—	—
			CRHEATER326A00	10.5	7.9/9.6	26.9/32.9	040	040	—	—
			CRHEATER327A00	13.0	9.8/11.9	33.3/40.7	040	040	—	—
		HIGH	CRHEATER323A00	4.4	3.3/4.0	11.3/13.8	—	—	—	—
			CRHEATER324A00	6.5	4.9/6.0	16.7/20.4	—	—	—	—
	CRHEATER325A00		8.7	6.5/8.0	22.3/27.3	037	037	—	—	
	CRHEATER326A00		10.5	7.9/9.6	26.9/32.9	040	040	—	—	
	CRHEATER327A00		13.0	9.8/11.9	33.3/40.7	040	040	—	—	
	208/230-3-60	STD	CRHEATER323A00	4.4	3.3/4.0	11.3/13.8	—	—	—	—
			CRHEATER324A00	6.5	4.9/6.0	16.7/20.4	—	—	—	—
			CRHEATER325A00	8.7	6.5/8.0	22.3/27.3	—	—	—	—
			CRHEATER326A00	10.5	7.9/9.6	26.9/32.9	—	—	—	—
			CRHEATER328A00	16.0	12.0/14.7	41.0/50.1	037	037	037	038
		MED	CRHEATER323A00	4.4	3.3/4.0	11.3/13.8	—	—	—	—
			CRHEATER324A00	6.5	4.9/6.0	16.7/20.4	—	—	—	—
			CRHEATER325A00	8.7	6.5/8.0	22.3/27.3	—	—	—	—
			CRHEATER326A00	10.5	7.9/9.6	26.9/32.9	—	—	—	—
HIGH		CRHEATER328A00	16.0	12.0/14.7	41.0/50.1	037	037	037	038	
		CRHEATER323A00	4.4	3.3/4.0	11.3/13.8	—	—	—	—	
		CRHEATER324A00	6.5	4.9/6.0	16.7/20.4	—	—	—	—	
	CRHEATER325A00	8.7	6.5/8.0	22.3/27.3	—	—	—	—		
	CRHEATER326A00	10.5	7.9/9.6	26.9/32.9	—	—	—	—		
460-3-60	STD	CRHEATER333A00	6.0	5.5	18.8	—	—	—	—	
		CRHEATER334A00	8.8	8.1	27.6	—	—	—	—	
		CRHEATER335A00	11.5	10.6	36.0	—	—	—	—	
		CRHEATER336A00	14.0	12.9	43.9	—	—	—	—	
	MED	CRHEATER333A00	6.0	5.5	18.8	—	—	—	—	
		CRHEATER334A00	8.8	8.1	27.6	—	—	—	—	
		CRHEATER335A00	11.5	10.6	36.0	—	—	—	—	
		CRHEATER336A00	14.0	12.9	43.9	—	—	—	—	
	HIGH	CRHEATER333A00	6.0	5.5	18.8	—	—	—	—	
		CRHEATER334A00	8.8	8.1	27.6	—	—	—	—	
		CRHEATER335A00	11.5	10.6	36.0	—	—	—	—	
		CRHEATER336A00	14.0	12.9	43.9	—	—	—	—	
575-3-60	STD	CRHEATER339A00	10.0	9.2	31.3	—	—	—	—	
		CRHEATER340A00	15.0	13.8	47.0	—	—	—	—	
	MED	CRHEATER339A00	10.0	9.2	31.3	—	—	—	—	
		CRHEATER340A00	15.0	13.8	47.0	—	—	—	—	
	HIGH	CRHEATER339A00	10.0	9.2	31.3	—	—	—	—	
		CRHEATER340A00	15.0	13.8	47.0	—	—	—	—	

50GC**04 ELECTRIC HEAT DATA — WITH NON-FUSED DISCONNECT

50GC UNIT SIZE	NOM. V-Ph-Hz	IFM TYPE	ELECTRIC HEATER PART NUMBER	NOM (kW)	APPLICATION (kW)	APPLICATION OUTPUT (MBH)	SINGLE POINT OR JUNCTION PART NUMBER CRSINGLEXXA00			
							NO C.O. OR UNPOWERED C.O.		w/PWRD C.O.	
							NO P.E.	w/P.E. (pwrd fr/unit)	NO P.E.	w/P.E. (pwrd fr/unit)
208/230-1-60	STD	CRHEATER323A00	4.4	3.3/4.0	11.3/13.8	037	037	—	—	
			6.5	4.9/6.0	16.7/20.4	037	037	—	—	
			8.7	6.5/8.0	22.3/27.3	037	037	—	—	
			10.5	7.9/9.6	26.9/32.9	037	040	—	—	
			13.0	9.8/11.9	33.3/40.7	040	040	—	—	
		CRHEATER324A00	4.4	3.3/4.0	11.3/13.8	037	037	—	—	
			6.5	4.9/6.0	16.7/20.4	037	037	—	—	
			8.7	6.5/8.0	22.3/27.3	037	037	—	—	
			10.5	7.9/9.6	26.9/32.9	040	040	—	—	
			13.0	9.8/11.9	33.3/40.7	040	040	—	—	
	MED	CRHEATER323A00	4.4	3.3/4.0	11.3/13.8	037	037	—	—	
			6.5	4.9/6.0	16.7/20.4	037	037	—	—	
			8.7	6.5/8.0	22.3/27.3	037	037	—	—	
			10.5	7.9/9.6	26.9/32.9	040	040	—	—	
			13.0	9.8/11.9	33.3/40.7	040	040	—	—	
		CRHEATER324A00	4.4	3.3/4.0	11.3/13.8	037	037	—	—	
			6.5	4.9/6.0	16.7/20.4	037	037	—	—	
			8.7	6.5/8.0	22.3/27.3	037	037	—	—	
			10.5	7.9/9.6	26.9/32.9	040	040	—	—	
			13.0	9.8/11.9	33.3/40.7	040	040	—	—	
HIGH	CRHEATER323A00	4.4	3.3/4.0	11.3/13.8	037	037	—	—		
		6.5	4.9/6.0	16.7/20.4	037	037	—	—		
		8.7	6.5/8.0	22.3/27.3	037	037	—	—		
		10.5	7.9/9.6	26.9/32.9	040	040	—	—		
		13.0	9.8/11.9	33.3/40.7	040	040	—	—		
	CRHEATER324A00	4.4	3.3/4.0	11.3/13.8	037	037	—	—		
		6.5	4.9/6.0	16.7/20.4	037	037	—	—		
		8.7	6.5/8.0	22.3/27.3	037	037	—	—		
		10.5	7.9/9.6	26.9/32.9	040	040	—	—		
		13.0	9.8/11.9	33.3/40.7	040	040	—	—		
208/230-3-60	STD	CRHEATER323A00	4.4	3.3/4.0	11.3/13.8	037	037	037	037	
			6.5	4.9/6.0	16.7/20.4	037	037	037	037	
			8.7	6.5/8.0	22.3/27.3	037	037	037	037	
			10.5	7.9/9.6	26.9/32.9	037	037	037	037	
			16.0	12.0/14.7	41.0/50.1	037	037	037	038	
	CRHEATER324A00	4.4	3.3/4.0	11.3/13.8	037	037	037	037		
		6.5	4.9/6.0	16.7/20.4	037	037	037	037		
		8.7	6.5/8.0	22.3/27.3	037	037	037	037		
		10.5	7.9/9.6	26.9/32.9	037	037	037	037		
		16.0	12.0/14.7	41.0/50.1	037	037	038	038		
	MED	CRHEATER323A00	4.4	3.3/4.0	11.3/13.8	037	037	037	037	
			6.5	4.9/6.0	16.7/20.4	037	037	037	037	
			8.7	6.5/8.0	22.3/27.3	037	037	037	037	
			10.5	7.9/9.6	26.9/32.9	037	037	037	037	
			16.0	12.0/14.7	41.0/50.1	037	037	038	038	
	CRHEATER324A00	4.4	3.3/4.0	11.3/13.8	037	037	037	037		
		6.5	4.9/6.0	16.7/20.4	037	037	037	037		
		8.7	6.5/8.0	22.3/27.3	037	037	037	037		
		10.5	7.9/9.6	26.9/32.9	037	037	037	037		
		16.0	12.0/14.7	41.0/50.1	037	037	038	038		
HIGH	CRHEATER323A00	4.4	3.3/4.0	11.3/13.8	037	037	037	037		
		6.5	4.9/6.0	16.7/20.4	037	037	037	037		
		8.7	6.5/8.0	22.3/27.3	037	037	037	037		
		10.5	7.9/9.6	26.9/32.9	037	037	037	037		
		16.0	12.0/14.7	41.0/50.1	037	037	038	038		
460-3-60	STD	CRHEATER333A00	6.0	5.5	18.8	—	—	—	—	
			8.8	8.1	27.6	—	—	—	—	
			11.5	10.6	36.0	—	—	—	—	
			14.0	12.9	43.9	—	—	—	—	
	MED	CRHEATER333A00	6.0	5.5	18.8	—	—	—	—	
			8.8	8.1	27.6	—	—	—	—	
			11.5	10.6	36.0	—	—	—	—	
			14.0	12.9	43.9	—	—	—	—	
	HIGH	CRHEATER333A00	6.0	5.5	18.8	—	—	—	—	
			8.8	8.1	27.6	—	—	—	—	
			11.5	10.6	36.0	—	—	—	—	
			14.0	12.9	43.9	—	—	—	—	
575-3-60	STD	CRHEATER339A00	10.0	9.2	31.3	—	—	—	—	
			15.0	13.8	47.0	—	—	—	—	
	MED	CRHEATER339A00	10.0	9.2	31.3	—	—	—	—	
			15.0	13.8	47.0	—	—	—	—	
	HIGH	CRHEATER339A00	10.0	9.2	31.3	—	—	—	—	
			15.0	13.8	47.0	—	—	—	—	

50GC**05 ELECTRIC HEAT DATA — WITHOUT NON-FUSED DISCONNECT

50GC UNIT SIZE	NOM. V-Ph-Hz	IFM TYPE	ELECTRIC HEATER PART NUMBER	NOM (kW)	APPLICATION (kW)	APPLICATION OUTPUT (MBH)	SINGLE POINT OR JUNCTION PART NUMBER CRSINGLEXXXXA00			
							NO C.O. OR UNPOWERED C.O.		w/PWRD C.O.	
							NO P.E.	w/P.E. (pwrd fr/unit)	NO P.E.	w/P.E. (pwrd fr/unit)
208/230-1-60	STD	CRHEATER323A00	4.4	3.3/4.0	11.3/13.8	—	—	—	—	
		CRHEATER325A00	8.7	6.5/8.0	22.3/27.3	037	037	—	—	
		CRHEATER327A00	13.0	9.8/11.9	33.3/40.7	040	040	—	—	
		CRHEATER329A00	17.4	13.1/16.0	44.6/54.5	040	040	—	—	
		CRHEATER330A00*	19.2	14.4/17.6	49.2/60.2	040	040	—	—	
		CRHEATER331A00†	21.0	15.8/19.3	53.8/65.8	040	040	—	—	
		CRHEATER323A00	4.4	3.3/4.0	11.3/13.8	—	—	—	—	
		CRHEATER325A00	8.7	6.5/8.0	22.3/27.3	037	037	—	—	
		CRHEATER327A00	13.0	9.8/11.9	33.3/40.7	040	040	—	—	
		CRHEATER329A00	17.4	13.1/16.0	44.6/54.5	040	040	—	—	
		CRHEATER330A00*	19.2	14.4/17.6	49.2/60.2	040	040	—	—	
		CRHEATER331A00†	21.0	15.8/19.3	53.8/65.8	040	040	—	—	
		CRHEATER323A00	4.4	3.3/4.0	11.3/13.8	—	—	—	—	
		CRHEATER325A00	8.7	6.5/8.0	22.3/27.3	037	037	—	—	
		CRHEATER327A00	13.0	9.8/11.9	33.3/40.7	040	040	—	—	
	CRHEATER329A00	17.4	13.1/16.0	44.6/54.5	040	040	—	—		
	CRHEATER330A00*	19.2	14.4/17.6	49.2/60.2	040	040	—	—		
	CRHEATER331A00†	21.0	15.8/19.3	53.8/65.8	040	040	—	—		
	208/230-3-60	STD	CRHEATER323A00	4.4	3.3/4.0	11.3/13.8	—	—	—	—
			CRHEATER324A00	6.5	4.9/6.0	16.7/20.4	—	—	—	—
			CRHEATER325A00	8.7	6.5/8.0	22.3/27.3	—	—	—	—
			CRHEATER328A00	16.0	12.0/14.7	41.0/50.1	037	037	038	038
			CRHEATER330A00*	19.2	14.4/17.6	49.2/60.2	038	038	038	038
			CRHEATER331A00†	21.0	15.8/19.3	53.8/65.8	038	038	038	038
		MED	CRHEATER323A00	4.4	3.3/4.0	11.3/13.8	—	—	—	—
			CRHEATER324A00	6.5	4.9/6.0	16.7/20.4	—	—	—	—
			CRHEATER325A00	8.7	6.5/8.0	22.3/27.3	—	—	—	—
CRHEATER328A00			16.0	12.0/14.7	41.0/50.1	037	037	038	038	
CRHEATER330A00*			19.2	14.4/17.6	49.2/60.2	038	038	038	038	
CRHEATER331A00†			21.0	15.8/19.3	53.8/65.8	038	038	038	038	
HIGH	CRHEATER323A00	4.4	3.3/4.0	11.3/13.8	—	—	—	—		
	CRHEATER324A00	6.5	4.9/6.0	16.7/20.4	—	—	—	—		
	CRHEATER325A00	8.7	6.5/8.0	22.3/27.3	—	—	—	—		
	CRHEATER328A00	16.0	12.0/14.7	41.0/50.1	037	037	038	038		
	CRHEATER330A00*	19.2	14.4/17.6	49.2/60.2	038	038	038	038		
	CRHEATER331A00†	21.0	15.8/19.3	53.8/65.8	038	038	038	038		
460-3-60	STD	CRHEATER333A00	6.0	5.5	18.8	—	—	—	—	
		CRHEATER335A00	11.5	10.6	36.0	—	—	—	—	
		CRHEATER336A00	14.0	12.9	43.9	—	—	—	—	
		CRHEATER337A00	21.5	19.7	67.4	037	037	037	037	
	MED	CRHEATER333A00	6.0	5.5	18.8	—	—	—	—	
		CRHEATER335A00	11.5	10.6	36.0	—	—	—	—	
		CRHEATER336A00	14.0	12.9	43.9	—	—	—	—	
		CRHEATER337A00	21.5	19.7	67.4	037	037	037	037	
	HIGH	CRHEATER333A00	6.0	5.5	18.8	—	—	—	—	
		CRHEATER335A00	11.5	10.6	36.0	—	—	—	—	
		CRHEATER336A00	14.0	12.9	43.9	—	—	—	—	
		CRHEATER337A00	21.5	19.7	67.4	037	037	037	037	
575-3-60	STD	CRHEATER339A00	10.0	9.2	31.3	—	—	—	—	
		CRHEATER340A00	15.0	13.8	47.0	—	—	—	—	
	MED	CRHEATER339A00	10.0	9.2	31.3	—	—	—	—	
		CRHEATER340A00	15.0	13.8	47.0	—	—	—	—	
	HIGH	CRHEATER339A00	10.0	9.2	31.3	—	—	—	—	
		CRHEATER340A00	15.0	13.8	47.0	—	—	—	—	

*Do not use with size 05 horizontal duct configuration units.

†Do not use with size 05 vertical duct configuration units.

50GC**05 ELECTRIC HEAT DATA — WITH NON-FUSED DISCONNECT

50GC UNIT SIZE	NOM. V-Ph-Hz	IFM TYPE	ELECTRIC HEATER PART NUMBER	NOM (kW)	APPLICATION (kW)	APPLICATION OUTPUT (MBH)	SINGLE POINT OR JUNCTION PART NUMBER CRSINGLEXXXA00			
							NO C.O. OR UNPOWERED C.O.		w/PWRD C.O.	
							NO P.E.	w/P.E. (pwrd fr/unit)	NO P.E.	w/P.E. (pwrd fr/unit)
208/230-1-60	STD	CRHEATER323A00	4.4	3.3/4.0	11.3/13.8	037	037	—	—	
		CRHEATER325A00	8.7	6.5/8.0	22.3/27.3	037	037	—	—	
		CRHEATER327A00	13.0	9.8/11.9	33.3/40.7	040	040	—	—	
		CRHEATER329A00	17.4	13.1/16.0	44.6/54.5	040	040	—	—	
		CRHEATER330A00*	19.2	14.4/17.6	49.2/60.2	040	040	—	—	
		CRHEATER331A00†	21.0	15.8/19.3	53.8/65.8	040	040	—	—	
		CRHEATER323A00	4.4	3.3/4.0	11.3/13.8	037	037	—	—	
		CRHEATER325A00	8.7	6.5/8.0	22.3/27.3	037	037	—	—	
		CRHEATER327A00	13.0	9.8/11.9	33.3/40.7	040	040	—	—	
		CRHEATER329A00	17.4	13.1/16.0	44.6/54.5	040	040	—	—	
		CRHEATER330A00*	19.2	14.4/17.6	49.2/60.2	040	040	—	—	
		CRHEATER331A00†	21.0	15.8/19.3	53.8/65.8	040	040	—	—	
		CRHEATER323A00	4.4	3.3/4.0	11.3/13.8	037	037	—	—	
		CRHEATER325A00	8.7	6.5/8.0	22.3/27.3	037	037	—	—	
		CRHEATER327A00	13.0	9.8/11.9	33.3/40.7	040	040	—	—	
	CRHEATER329A00	17.4	13.1/16.0	44.6/54.5	040	040	—	—		
	CRHEATER330A00*	19.2	14.4/17.6	49.2/60.2	040	040	—	—		
	CRHEATER331A00†	21.0	15.8/19.3	53.8/65.8	040	040	—	—		
	208/230-3-60	STD	CRHEATER323A00	4.4	3.3/4.0	11.3/13.8	037	037	037	037
			CRHEATER324A00	6.5	4.9/6.0	16.7/20.4	037	037	037	037
			CRHEATER325A00	8.7	6.5/8.0	22.3/27.3	037	037	037	037
			CRHEATER328A00	16.0	12.0/14.7	41.0/50.1	037	037	038	038
			CRHEATER330A00*	19.2	14.4/17.6	49.2/60.2	038	038	038	038
			CRHEATER331A00†	21.0	15.8/19.3	53.8/65.8	038	038	038	038
		MED	CRHEATER323A00	4.4	3.3/4.0	11.3/13.8	037	037	037	037
			CRHEATER324A00	6.5	4.9/6.0	16.7/20.4	037	037	037	037
			CRHEATER325A00	8.7	6.5/8.0	22.3/27.3	037	037	037	037
CRHEATER328A00			16.0	12.0/14.7	41.0/50.1	037	037	038	038	
CRHEATER330A00*			19.2	14.4/17.6	49.2/60.2	038	038	038	038	
CRHEATER331A00†			21.0	15.8/19.3	53.8/65.8	038	038	038	038	
HIGH	CRHEATER323A00	4.4	3.3/4.0	11.3/13.8	037	037	037	037		
	CRHEATER324A00	6.5	4.9/6.0	16.7/20.4	037	037	037	037		
	CRHEATER325A00	8.7	6.5/8.0	22.3/27.3	037	037	037	037		
	CRHEATER328A00	16.0	12.0/14.7	41.0/50.1	037	037	038	038		
	CRHEATER330A00*	19.2	14.4/17.6	49.2/60.2	038	038	038	038		
	CRHEATER331A00†	21.0	15.8/19.3	53.8/65.8	038	038	038	038		
460-3-60	STD	CRHEATER333A00	6.0	5.5	18.8	—	—	—	—	
		CRHEATER335A00	11.5	10.6	36.0	—	—	—	—	
		CRHEATER336A00	14.0	12.9	43.9	—	—	—	—	
		CRHEATER337A00	21.5	19.7	67.4	037	037	037	037	
	MED	CRHEATER333A00	6.0	5.5	18.8	—	—	—	—	
		CRHEATER335A00	11.5	10.6	36.0	—	—	—	—	
		CRHEATER336A00	14.0	12.9	43.9	—	—	—	—	
		CRHEATER337A00	21.5	19.7	67.4	037	037	037	037	
	HIGH	CRHEATER333A00	6.0	5.5	18.8	—	—	—	—	
		CRHEATER335A00	11.5	10.6	36.0	—	—	—	—	
		CRHEATER336A00	14.0	12.9	43.9	—	—	—	—	
		CRHEATER337A00	21.5	19.7	67.4	037	037	037	037	
575-3-60	STD	CRHEATER339A00	10.0	9.2	31.3	—	—	—	—	
		CRHEATER340A00	15.0	13.8	47.0	—	—	—	—	
	MED	CRHEATER339A00	10.0	9.2	31.3	—	—	—	—	
		CRHEATER340A00	15.0	13.8	47.0	—	—	—	—	
	HIGH	CRHEATER339A00	10.0	9.2	31.3	—	—	—	—	
		CRHEATER340A00	15.0	13.8	47.0	—	—	—	—	

*Do not use with size 05 horizontal duct configuration units.

†Do not use with size 05 vertical duct configuration units.

50GC**06 ELECTRIC HEAT DATA — WITHOUT NON-FUSED DISCONNECT

50GC UNIT SIZE	NOM. V-Ph-Hz	IFM TYPE	ELECTRIC HEATER PART NUMBER	NOM (kW)	APPLICATION (kW)	APPLICATION OUTPUT (MBH)	SINGLE POINT OR JUNCTION PART NUMBER CRSINGLEX000			
							NO C.O. OR UNPOWERED C.O.		w/PWRD C.O.	
							NO P.E.	w/P.E. (pwrd fr/unit)	NO P.E.	w/P.E. (pwrd fr/unit)
**06	208/230-1-60	STD	CRHEATER324A00	6.5	4.9/6.0	16.7/20.4	—	—	—	—
			CRHEATER325A00	8.7	6.5/8.0	22.3/27.3	037	037	—	—
			CRHEATER327A00	13.0	9.8/11.9	33.3/40.7	040	040	—	—
			CRHEATER329A00	17.4	13.1/16.0	44.6/54.5	040	040	—	—
			CRHEATER331A00	21.0	15.8/19.3	53.8/65.8	040	040	—	—
		MED	CRHEATER324A00	6.5	4.9/6.0	16.7/20.4	-	-	—	—
			CRHEATER325A00	8.7	6.5/8.0	22.3/27.3	037	037	—	—
			CRHEATER327A00	13.0	9.8/11.9	33.3/40.7	040	040	—	—
			CRHEATER329A00	17.4	13.1/16.0	44.6/54.5	040	040	—	—
			CRHEATER331A00	21.0	15.8/19.3	53.8/65.8	040	040	—	—
	208/230-3-60	STD	CRHEATER324A00	6.5	4.9/6.0	16.7/20.4	—	—	—	—
			CRHEATER326A00	10.5	7.9/9.6	26.9/32.9	—	—	—	—
			CRHEATER328A00	16.0	12.0/14.7	41.0/50.1	037	037	038	038
			CRHEATER331A00	21.0	15.8/19.3	53.8/65.8	038	038	038	038
			CRHEATER332A00	24.5	18.4/22.5	62.8/76.8	038	038	038	038
		MED	CRHEATER324A00	6.5	4.9/6.0	16.7/20.4	—	—	—	—
			CRHEATER326A00	10.5	7.9/9.6	26.9/32.9	—	—	—	037
			CRHEATER328A00	16.0	12.0/14.7	41.0/50.1	037	038	038	038
			CRHEATER331A00	21.0	15.8/19.3	53.8/65.8	038	038	038	038
			CRHEATER332A00	24.5	18.4/22.5	62.8/76.8	038	038	038	038
HIGH	CRHEATER324A00	6.5	4.9/6.0	16.7/20.4	—	—	—	—		
	CRHEATER326A00	10.5	7.9/9.6	26.9/32.9	—	—	—	—		
	CRHEATER328A00	16.0	12.0/14.7	41.0/50.1	037	037	038	038		
	CRHEATER331A00	21.0	15.8/19.3	53.8/65.8	038	038	038	038		
	CRHEATER332A00	24.5	18.4/22.5	62.8/76.8	038	038	038	038		
460-3-60	STD	CRHEATER333A00	6.0	5.5	18.8	—	—	—	—	
		CRHEATER335A00	11.5	10.6	36.0	—	—	—	—	
		CRHEATER336A00	14.0	12.9	43.9	—	—	—	—	
		CRHEATER337A00	21.5	19.7	67.4	037	037	037	037	
		CRHEATER338A00	24.0	22.0	75.2	037	037	037	037	
	MED	CRHEATER333A00	6.0	5.5	18.8	—	—	—	—	
		CRHEATER335A00	11.5	10.6	36.0	—	—	—	—	
		CRHEATER336A00	14.0	12.9	43.9	—	—	—	—	
		CRHEATER337A00	21.5	19.7	67.4	037	037	037	037	
		CRHEATER338A00	24.0	22.0	75.2	037	037	037	037	
	HIGH	CRHEATER333A00	6.0	5.5	18.8	—	—	—	—	
		CRHEATER335A00	11.5	10.6	36.0	—	—	—	—	
		CRHEATER336A00	14.0	12.9	43.9	—	—	—	—	
		CRHEATER337A00	21.5	19.7	67.4	037	037	037	037	
		CRHEATER338A00	24.0	22.0	75.2	037	037	037	037	
575-3-60	STD	CRHEATER340A00	15.0	13.8	47.0	—	—	—	—	
		CRHEATER341A00	21.0	19.3	65.8	037	037	037	037	
	MED	CRHEATER340A00	15.0	13.8	47.0	—	—	—	—	
		CRHEATER341A00	21.0	19.3	65.8	037	037	037	037	
	HIGH	CRHEATER340A00	15.0	13.8	47.0	—	—	—	—	
		CRHEATER341A00	21.0	19.3	65.8	037	037	037	037	

50GC**06 ELECTRIC HEAT DATA — WITH NON-FUSED DISCONNECT

50GC UNIT SIZE	NOM. V-Ph-Hz	IFM TYPE	ELECTRIC HEATER PART NUMBER	NOM (kW)	APPLICATION (kW)	APPLICATION OUTPUT (MBH)	SINGLE POINT OR JUNCTION PART NUMBER CRSINGLEXXXXA00			
							NO C.O. OR UNPOWERED C.O.		w/PWRD C.O.	
							NO P.E.	w/P.E. (pwrd fr/unit)	NO P.E.	w/P.E. (pwrd fr/unit)
208/230-1-60	STD	CRHEATER324A00	6.5	4.9/6.0	16.7/20.4	037	037	—	—	
		CRHEATER325A00	8.7	6.5/8.0	22.3/27.3	037	037	—	—	
		CRHEATER327A00	13.0	9.8/11.9	33.3/40.7	040	040	—	—	
		CRHEATER329A00	17.4	13.1/16.0	44.6/54.5	040	040	—	—	
		CRHEATER331A00	21.0	15.8/19.3	53.8/65.8	040	040	—	—	
	MED	CRHEATER324A00	6.5	4.9/6.0	16.7/20.4	037	037	—	—	
		CRHEATER325A00	8.7	6.5/8.0	22.3/27.3	037	037	—	—	
		CRHEATER327A00	13.0	9.8/11.9	33.3/40.7	040	040	—	—	
		CRHEATER329A00	17.4	13.1/16.0	44.6/54.5	040	040	—	—	
		CRHEATER331A00	21.0	15.8/19.3	53.8/65.8	040	040	—	—	
	208/230-3-60	STD	CRHEATER324A00	6.5	4.9/6.0	16.7/20.4	037	037	037	037
			CRHEATER326A00	10.5	7.9/9.6	26.9/32.9	037	037	037	037
CRHEATER328A00			16.0	12.0/14.7	41.0/50.1	037	037	038	038	
CRHEATER331A00			21.0	15.8/19.3	53.8/65.8	038	038	038	038	
CRHEATER332A00			24.5	18.4/22.5	62.8/76.8	038	038	038	038	
MED		CRHEATER324A00	6.5	4.9/6.0	16.7/20.4	037	037	037	037	
		CRHEATER326A00	10.5	7.9/9.6	26.9/32.9	037	037	037	037	
		CRHEATER328A00	16.0	12.0/14.7	41.0/50.1	037	038	038	038	
		CRHEATER331A00	21.0	15.8/19.3	53.8/65.8	038	038	038	038	
		CRHEATER332A00	24.5	18.4/22.5	62.8/76.8	038	038	038	038	
HIGH		CRHEATER324A00	6.5	4.9/6.0	16.7/20.4	037	037	037	037	
		CRHEATER326A00	10.5	7.9/9.6	26.9/32.9	037	037	037	037	
	CRHEATER328A00	16.0	12.0/14.7	41.0/50.1	037	037	038	038		
	CRHEATER331A00	21.0	15.8/19.3	53.8/65.8	038	038	038	038		
	CRHEATER332A00	24.5	18.4/22.5	62.8/76.8	038	038	038	038		
460-3-60	STD	CRHEATER333A00	6.0	5.5	18.8	—	—	—	—	
		CRHEATER335A00	11.5	10.6	36.0	—	—	—	—	
		CRHEATER336A00	14.0	12.9	43.9	—	—	—	—	
		CRHEATER337A00	21.5	19.7	67.4	037	037	037	037	
		CRHEATER338A00	24.0	22.0	75.2	037	037	037	037	
	MED	CRHEATER333A00	6.0	5.5	18.8	—	—	—	—	
		CRHEATER335A00	11.5	10.6	36.0	—	—	—	—	
		CRHEATER336A00	14.0	12.9	43.9	—	—	—	—	
		CRHEATER337A00	21.5	19.7	67.4	037	037	037	037	
		CRHEATER338A00	24.0	22.0	75.2	037	037	037	037	
	HIGH	CRHEATER333A00	6.0	5.5	18.8	—	—	—	—	
		CRHEATER335A00	11.5	10.6	36.0	—	—	—	—	
CRHEATER336A00		14.0	12.9	43.9	—	—	—	—		
CRHEATER337A00		21.5	19.7	67.4	037	037	037	037		
CRHEATER338A00		24.0	22.0	75.2	037	037	037	037		
575-3-60	STD	CRHEATER340A00	15.0	13.8	47.0	—	—	—	—	
		CRHEATER341A00	21.0	19.3	65.8	037	037	037	037	
	MED	CRHEATER340A00	15.0	13.8	47.0	—	—	—	—	
		CRHEATER341A00	21.0	19.3	65.8	037	037	037	037	
	HIGH	CRHEATER340A00	15.0	13.8	47.0	—	—	—	—	
		CRHEATER341A00	21.0	19.3	65.8	037	037	037	037	

TYPICAL CONTROL WIRING DIAGRAM — 48GC 04-06 208-230/3/60 UNIT WITH ELECTRO-MECHANICAL CONTROL AND W7220 ECONOMIZER

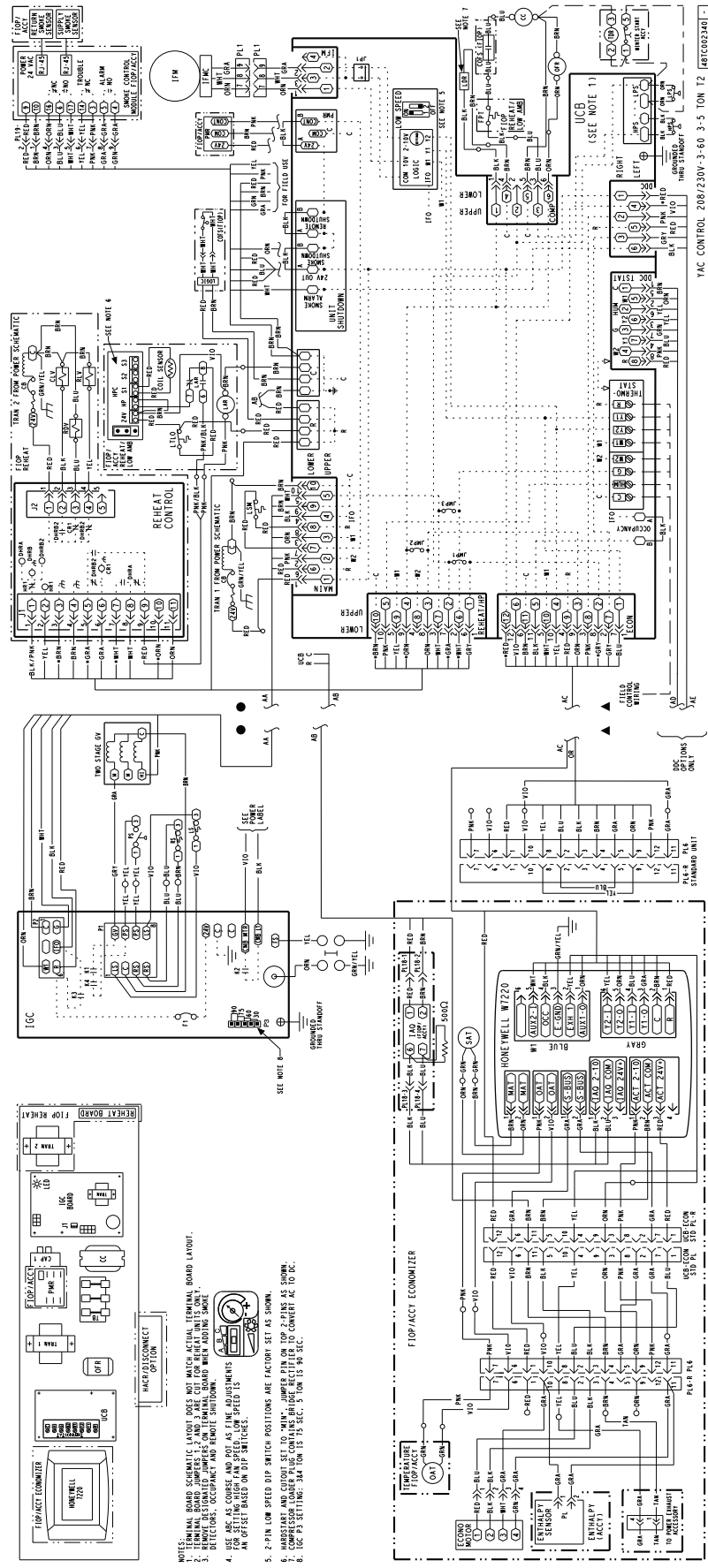

TYPICAL CONTROL WIRING DIAGRAM — 48GC 04-06 575/3/60 UNIT WITH ELECTRO-MECHANICAL CONTROL AND W7220 ECONOMIZER

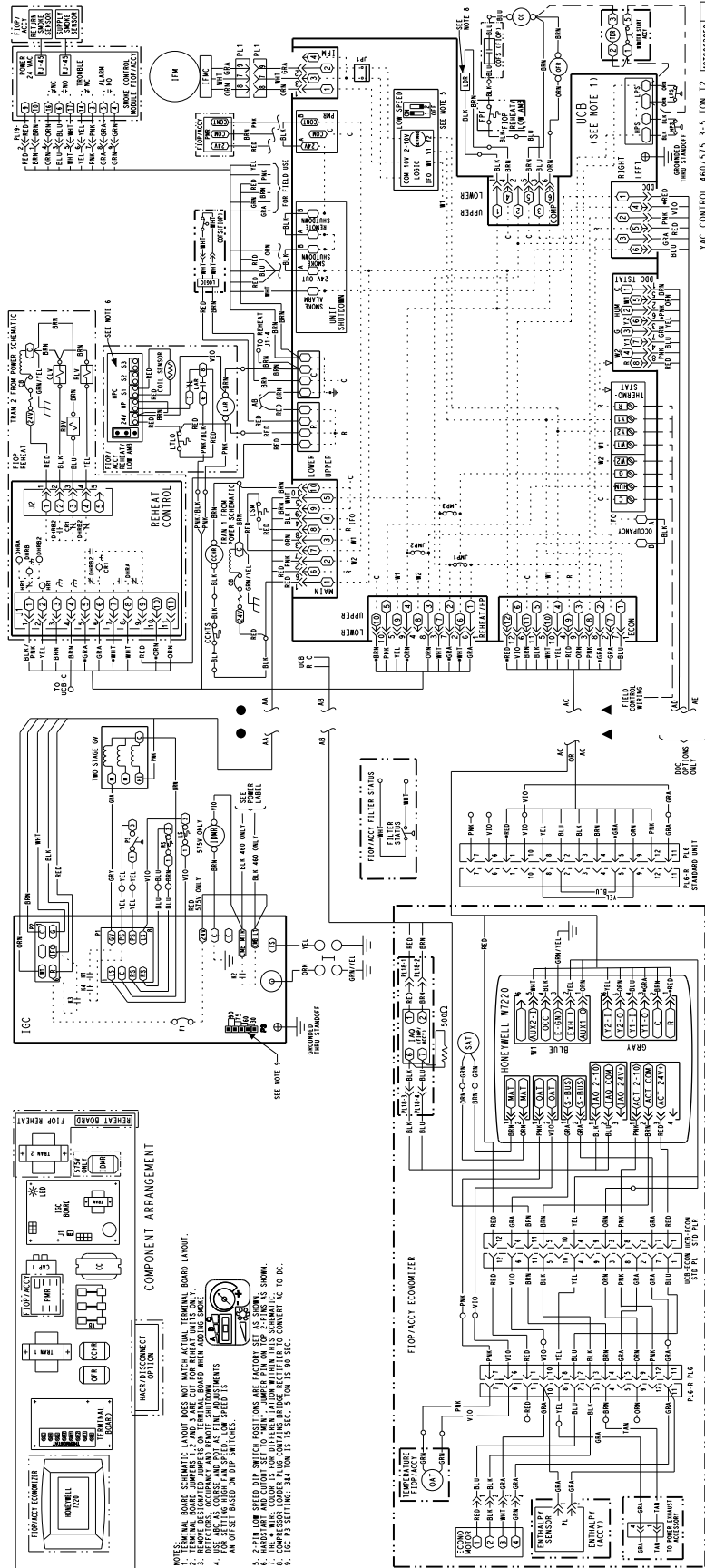

- NOTE: TERMINAL BOARD SCHEMATIC LAYOUT DOES NOT MATCH METAL TERMINAL BOARD LAYOUT.
1. TERMINAL BOARD JUMPS 1, 2 AND 3 ARE CUT FOR REHEAT UNITS ONLY.
 2. DETECTORS OCCUPANCY AND ROOMS SHUTDOWN ARE NOT SHOWN.
 3. FOR SETTING HIGH IN SPEED LOW SPEED IS AN OFFSET BASED ON DIP SWITCHES.
 4. 2-PIN LOW SPEED DIP SWITCH POSITIONS ARE FACTORY SET AS SHOWN.
 5. HARDWIRE AND CONTROL TO MAIN COMPRESSOR FROM ON/OFF 2-PIN AS SHOWN.
 6. COMPRESSOR LOADS PLUS CONTAINING RECTIFIER TO CONVERT AC TO DC.
 7. 16C PS SETTING: 34V 10A 15 SEC. 5 TON 15 PS SEC.

Typical wiring diagrams (cont)



TYPICAL 48GC 04-06 POWER WIRING DIAGRAM, 208-230/3/60 UNIT SHOWN

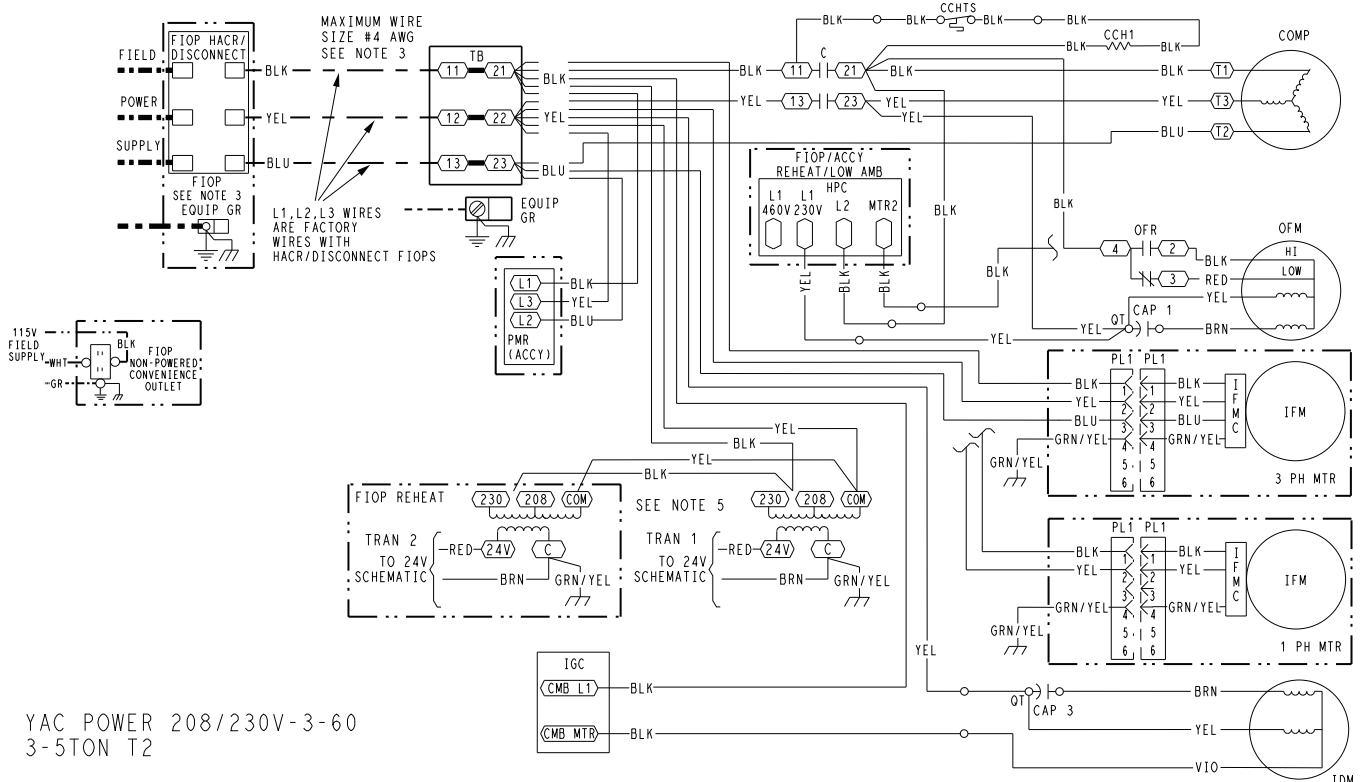

YAC POWER 208/230V-3-60
3-5TON T2

NOTES

- IF ANY OF THE ORIGINAL WIRE FURNISHED MUST BE REPLACED. IT MUST BE REPLACED WITH TYPE 90° C WIRE OR ITS EQUIVALENT.
- COMPRESSOR AND FAN MOTORS ARE THERMALLY PROTECTED.
- USE COPPER CONDUCTOR ONLY.
- DO NOT DISCONNECT POWER PLUG OR SIGNAL WIRE WHILE UNDER LOAD.
- ON 208/230V UNITS, TRAN IS WIRED FOR 230V. IF UNIT IS TO BE RUN WITH 208V POWER SUPPLY, DISCONNECT BLK WIRE FROM 230V TAP AND CONNECT TO 208V TAP.

LEGEND

- X MARKED WIRE
- TERMINAL (MARKED)
- TERMINAL (UNMARKED)
- X TERMINAL BLOCK
- SPLICE
- SPLICE (MARKED)
- FACTORY WIRING
- - - FIELD CONTROL WIRING
- - - - - FIELD POWER WIRING
- - - - - CIRCUIT BOARD TRACE
- - - - - ACCESSORY OR OPTIONAL WIRING

- ACCY ACCESSORY
- AUX AUXILIARY
- AWG AMERICAN WIRE GAGE
- BA BUILDING AUTOMATION NETWORK
- CC CONTACTOR, COMPRESSOR COMMON
- CAP CAPACITOR
- CB CIRCUIT BREAKER
- CCH CRANKCASE HEATER
- CCHR CRANKCASE HEATER RELAY
- CCHTS CRANKCASE HEATER TEMP SWITCH
- CLO COMPRESSOR LOCKOUT
- CLV COOLING LIQUID VALVE
- CMB CENTRIFUGAL MOTOR BLOWER
- COFS CONDENSATE OVERFLOW SWITCH
- COM SIGNAL COMMON
- COMP COMPRESSOR MOTOR
- DDC DIRECT DIGITAL CONTROL
- DFB DEFROST BOARD
- DFT DEFROST THERMOSTAT
- EHR ELECTRIC HEAT RELAY
- ENTH ENTHALPY
- EQUIP EQUIPMENT
- ERV ENERGY RECOVERY VENTILATOR
- ESL ENTHALPY SENSOR - LOW
- FB FUSE BLOCK
- FIOF FACTORY INSTALLED OPTION
- FPT FREEZE PROTECTION THERMOSTAT
- FS FLAME SWITCH
- FST FAN HOUSING TEMP. SENSOR
- FU FUSE
- G THERMOSTAT FAN CALL
- GR(GND) GROUND
- GV GAS VALVE

- HACR HEATING, AIR-CONDITIONING, REFRIGERATION BREAKER
- HGRH HOT GAS REHEAT
- HPC HEAD PRESSURE CONTROL
- HPS HIGH PRESSURE SWITCH
- HR HEATER RELAY
- HUM HUMIDISTAT
- I IGNITOR
- IAO INDOOR AIR QUALITY SENSORS
- IDM INDUCED DRAFT MOTOR
- IDMR INDUCED DRAFT RELAY
- IFM INDOOR FAN MOTOR
- IFMC INDOOR FAN MOTOR CONTROL
- IFO INDOOR FAN ON SIGNAL
- IGC INTEGRATED GAS CONTROL
- IRH INDOOR RELATIVE HUMIDITY
- JMP JUMPER
- L1 LINE 1
- LA LOW AMBIENT LOCKOUT
- LAR LOW AMBIENT RELAY
- LAS LOW AMBIENT SWITCH
- LDR COMPRESSOR LOADER
- LEN LOCAL EQUIPMENT NETWORK
- LOC LOSS OF CHARGE
- LOOP PWR CURRENT LOOP POWER
- LPS LOW PRESSURE SWITCH
- LS LIMIT SWITCH
- LSM LIMIT SWITCH (MANUAL RESET)
- LTL0 LOW TEMP LOCKOUT
- LTL1 LOW TEMP LOCKOUT
- MBB MAIN BASE BOARD
- MOV METAL OXIDE VARISTOR
- MTR MOTOR
- DAO OUTDOOR AIR QUALITY
- OAT OUTDOOR AIR TEMP. SENSOR
- OFM OUTDOOR FAN MOTOR
- OFR OUTDOOR FAN RELAY
- OL OVERLOAD

- PER POWER EXHAUST RELAY
- PH PHASE
- PL PLUG ASSEMBLY
- POT POTENTIOMETER
- PMR PHASE MONITOR RELAY
- PS PRESSURE SWITCH
- PWM PULSE WIDTH MODULATION
- QT QUADRUPLE TERMINAL
- R THERMOSTAT POWER
- RAT RETURN AIR TEMP. SENSOR
- RDV REHEAT DISCHARGE VALVE
- RH RELATIVE HUMIDITY
- RLV REHEAT LIQUID VALVE
- RNET LOCAL ACCESS NETWORK
- RS ROLLOUT SWITCH
- RVS REVERSING VALVE SOLENOID
- SAT SUPPLY AIR TEMP SENSOR
- SDP SYSTEM DISCHARGE PRESSURE
- SPRH SPACE RELATIVE HUMIDITY
- SPT SPACE TEMPERATURE SENSOR
- SPT0 SPACE TEMPERATURE OFFSET
- SSP SYSTEM SUCTION PRESSURE
- STD STANDARD
- SW SWITCH
- TB TERMINAL BLOCK
- TDR TIME DELAY RELAY
- TRAN TRANSFORMER
- UCB UNIT CONTROL BOARD
- W1 1st STAGE OF HEATING CALL
- W2 2nd STAGE OF HEATING CALL
- Y1 1st STAGE OF COOLING CALL
- Y2 2nd STAGE OF COOLING CALL

48TC002791 A

TYPICAL 48GC 04-06 POWER WIRING DIAGRAM, 460-575/3/60 UNIT SHOWN

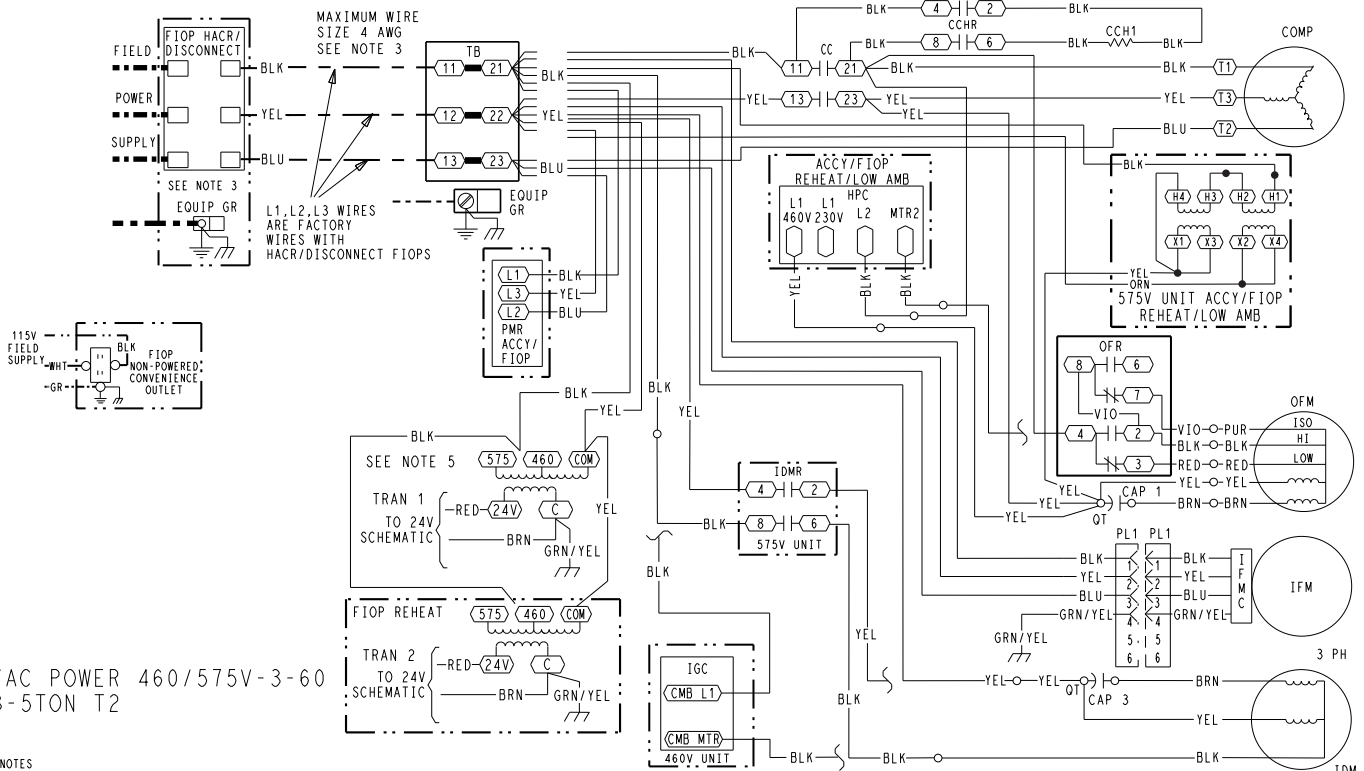

YAC POWER 460/575V-3-60
3-5TON T2

- NOTES**
- IF ANY OF THE ORIGINAL WIRE FURNISHED MUST BE REPLACED, IT MUST BE REPLACED WITH TYPE 90° C WIRE OR ITS EQUIVALENT
 - COMPRESSOR AND FAN MOTORS ARE THERMALLY PROTECTED.
 - USE COPPER CONDUCTOR ONLY.
 - DO NOT DISCONNECT POWER PLUG OR SIGNAL WIRE WHILE UNDER LOAD.
 - TRANSFORMER IS DEDICATED BASED ON UNIT VOLTAGE. TAPS ONLY SHOWN TO SIMPLIFY SCHEMATIC.

LEGEND

- MARKED WIRE
- TERMINAL (MARKED)
- TERMINAL (UNMARKED)
- TERMINAL BLOCK
- SPLICE
- SPLICE (MARKED)
- FACTORY WIRING
- FIELD CONTROL WIRING
- FIELD POWER WIRING
- CIRCUIT BOARD TRACE
- ACCESSORY OR OPTIONAL WIRING

ACCY	ACCESSORY	HGRH	HOT GAS REHEAT	PER	POWER EXHAUST RELAY
AUX	AUXILIARY	HPC	HEAD PRESSURE CONTROL	PH	PHASE
AWG	AMERICAN WIRE GAGE	HPS	HIGH PRESSURE SWITCH	PL	PLUG ASSEMBLY
BA	BUILDING AUTOMATION NETWORK	HR	HEATER RELAY	POT	POTENTIOMETER
CC	CONTACTOR, COMPRESSOR	HUM	HUMIDISTAT	PMR	PHASE MONITOR RELAY
CCM	COMMON	I	IGNITOR	PS	PRESSURE SWITCH
CAP	CAPACITOR	IAQ	INDOOR AIR QUALITY SENSORS	PWM	PULSE WIDTH MODULATION
CB	CIRCUIT BREAKER	IDM	INDUCED DRAFT MOTOR	QT	QUADRUPLE TERMINAL
CCH	CRANKCASE HEATER	IDMR	INDUCED DRAFT RELAY	R	THERMOSTAT POWER
CCHS	CRANKCASE HEATER TEMP SWITCH	IFM	INDOOR FAN MOTOR	RAT	RETURN AIR TEMP. SENSOR
CLO	COMPRESSOR LOCKOUT	IFMC	INDOOR FAN MOTOR CONTROL	RDV	REHEAT DISCHARGE VALVE
CLV	COOLING LIQUID VALVE	IFO	INDOOR FAN ON SIGNAL	RH	RELATIVE HUMIDITY
CMB	CENTRIFUGAL MOTOR BLOWER	IGC	INTEGRATED GAS CONTROL	RLV	REHEAT LIQUID VALVE
COFS	CONDENSATE OVERFLOW SWITCH	I	IGNITOR	RNET	LOCAL ACCESS NETWORK
COM	SIGNAL COMMON	IRH	INDOOR RELATIVE HUMIDITY	RS	ROLLOUT SWITCH
COMP	COMPRESSOR MOTOR	JMP	JUMPER	RVS	REVERSING VALVE SOLENOID
DDC	DIRECT DIGITAL CONTROL	L1	LINE 1	SAT	SUPPLY AIR TEMP SENSOR
DFB	DEFROST BOARD	LA	LOW AMBIENT LOCKOUT	SDP	SYSTEM DISCHARGE PRESSURE
DFT	DEFROST THERMOSTAT	LAR	LOW AMBIENT RELAY	SPRH	SPACE RELATIVE HUMIDITY
EHR	ELECTRIC HEAT RELAY	LAS	LOW AMBIENT SWITCH	SPT	SPACE TEMPERATURE SENSOR
ENTH	ENTHALPY	LDR	COMPRESSOR LOADER	SPTO	SPACE TEMPERATURE OFFSET
EQUIP	EQUIPMENT	LEN	LOCAL EQUIPMENT NETWORK	SSP	SYSTEM SUCTION PRESSURE
ERV	ENERGY RECOVERY VENTILATOR	LOSC	LOSS OF CHARGE	STD	STANDARD SWITCH
ESL	ENTHALPY SENSOR - LOW	LOOP	CURRENT LOOP POWER	SW	SWITCH
FB	FUSE BLOCK	LPS	LOW PRESSURE SWITCH	TB	TERMINAL BLOCK
FIOP	FACTORY INSTALLED OPTION	LS	LIMIT SWITCH	TDR	TIME DELAY RELAY
FPT	FREZE PROTECTION THERMOSTAT	LSM	LIMIT SWITCH (MANUAL RESET)	TRAN	TRANSFORMER
FS	FLAME SWITCH	LTL0	LOW TEMP LOCKOUT	UCB	UNIT CONTROL BOARD
FST	FAN HOUSING TEMP. SENSOR	MBB	MAIN BASE BOARD	W1	1st STAGE OF HEATING CALL
FU	FUSE	MOV	METAL OXIDE VARISTOR	W2	2nd STAGE OF HEATING CALL
G	THERMOSTAT FAN CALL	MTR	MOTOR	Y1	1st STAGE OF COOLING CALL
GR(GND)	GROUND	OAO	OUTDOOR AIR QUALITY	Y2	2nd STAGE OF COOLING CALL
GV	GAS VALVE	OAT	OUTDOOR AIR TEMP. SENSOR		
HACR	HEATING, AIR-CONDITIONING, REFRIGERATION BREAKER	OFM	OUTDOOR FAN MOTOR		
HGRH	HOT GAS REHEAT	OFR	OUTDOOR FAN RELAY		
		OL	OVERLOAD		

48TC002956 -

TYPICAL CONTROL WIRING DIAGRAM — 50GC 04-06 460-575/3/60 UNIT WITH ELECTRO-MECHANICAL CONTROL AND W7220 ECONOMIZER

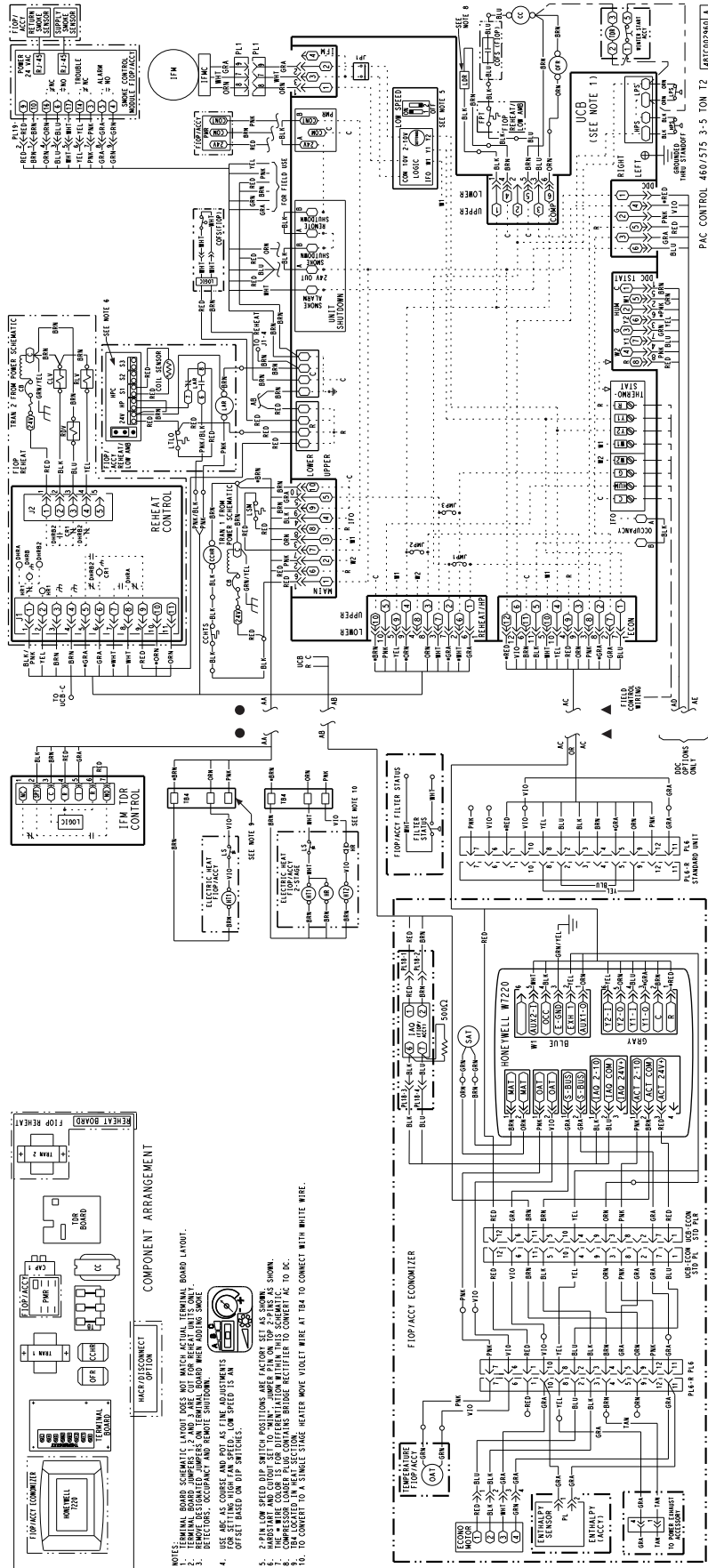

TYPICAL 50GC 04-06 POWER WIRING DIAGRAM, 208-230/3/60 UNIT SHOWN

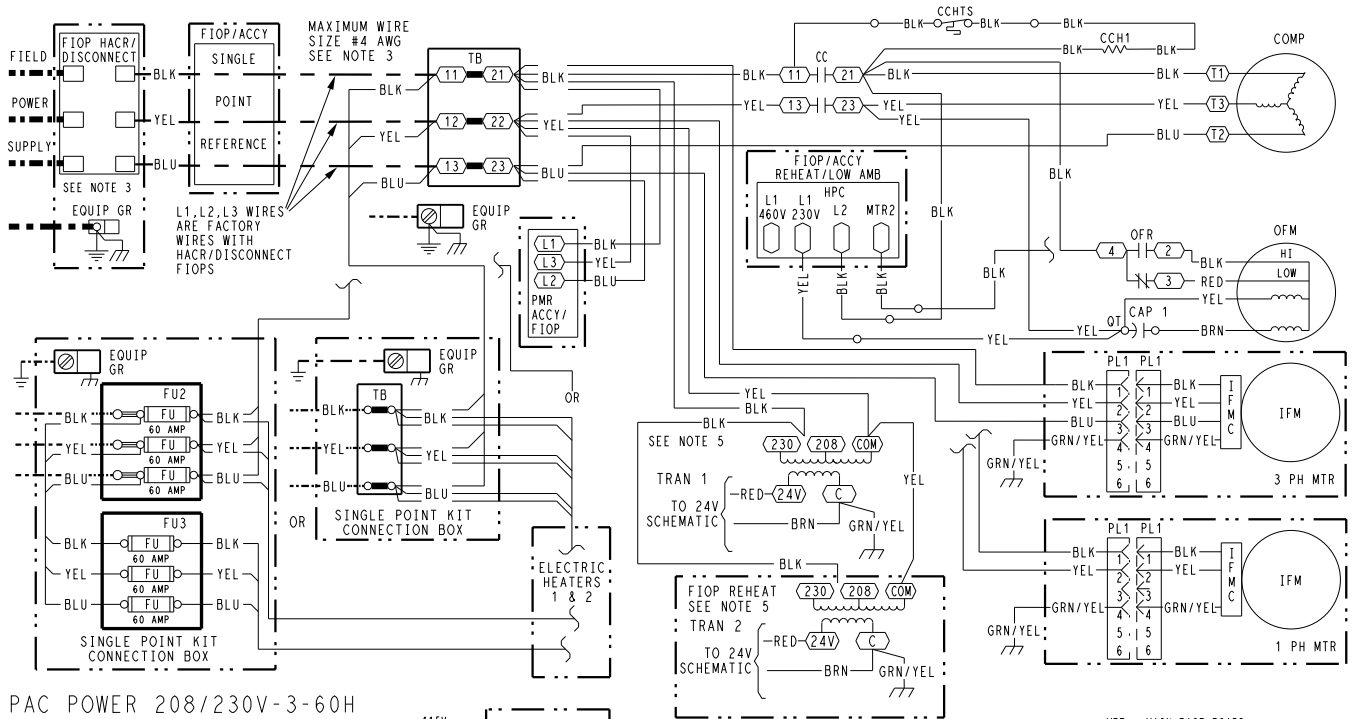

PAC POWER 208/230V-3-60H
3-5TON T2

NOTES

1. IF ANY OF THE ORIGINAL WIRE FURNISHED MUST BE REPLACED, IT MUST BE REPLACED WITH TYPE 90° C WIRE OR ITS EQUIVALENT.
2. COMPRESSOR AND FAN MOTORS ARE THERMALLY PROTECTED.
3. USE COPPER CONDUCTOR ONLY.
4. DO NOT DISCONNECT POWER PLUG OR SIGNAL WIRE WHILE UNDER LOAD.
5. ON 208/230V UNITS, TRAN IS WIRED FOR 230V. IF UNIT IS TO BE RUN WITH 208V POWER SUPPLY, DISCONNECT BLK WIRE FROM 230V TAP AND CONNECT TO 208V TAP.

LEGEND

- (X) MARKED WIRE
- (X) TERMINAL (MARKED)
- () TERMINAL (UNMARKED)
- [] TERMINAL BLOCK
- SPLICE
- SPLICE (MARKED)
- FACTORY WIRING
- - - FIELD CONTROL WIRING
- - - FIELD POWER WIRING
- - - CIRCUIT BOARD TRACE
- - - ACCESSORY OR OPTIONAL WIRING

- ACCY ACCESSORY
- AWG AMERICAN WIRE GAGE
- BAS BUILDING AUTOMATION NETWORK
- CC CONTACTOR, COMPRESSOR
- COM COMMON
- C CAPACITOR
- CB CIRCUIT BREAKER
- CCH CRANKCASE HEATER
- CCHR CRANKCASE HEATER RELAY
- CCHTS CRANKCASE HEATER TEMP SWITCH
- C COMPRESSOR LOCKOUT
- CLV COOLING LIQUID VALVE
- COFS CONDENSATE OVERFLOW SWITCH
- COM SIGNAL COMMON
- COMP COMPRESSOR MOTOR
- DDC DIRECT DIGITAL CONTROL
- DFB DEFROST BOARD
- DFT DEFROST THERMOSTAT
- EHR ELECTRIC HEAT RELAY
- ENTH ENTHALPY
- ERV ENERGY RECOVERY VENTILATOR
- ESL ENTHALPY SENSOR - LOW
- FB FUSE BLOCK
- FIOF FACTORY INSTALLED OPTION
- FPT FREEZE PROTECTION THERMOSTAT
- FST FAN HOUSING TEMP SENSOR
- FU FUSE

- G (GRIND) GROUND
- HACR HEATING, AIR-CONDITIONING, REFRIGERATION BREAKER
- HR HEATER RELAY
- HGRH HOT GAS REHEAT
- HPC HEAD PRESSURE CONTROL
- HPS HIGH PRESSURE SWITCH
- IAO INDOOR AIR QUALITY SENSORS
- IFM INDOOR FAN MOTOR
- IFMC INDOOR FAN MOTOR CONTROL
- IFO INDOOR FAN ON SIGNAL
- IRH INDOOR RELATIVE HUMIDITY
- JMP JUMPER
- L1 LINE 1
- LA LOW AMBIENT LOCKOUT
- LAR LOW AMBIENT RELAY
- LAS LOW AMBIENT SWITCH
- LDR COMPRESSOR LOADER
- LEN LOCAL EQUIPMENT NETWORK
- LOC LOSS OF CHARGE
- LOOP PWR CURRENT LOOP POWER
- LPS LOW PRESSURE SWITCH
- LS LIMIT SWITCH
- LSM LIMIT SWITCH (MANUAL RESET)
- LTLO LOW TEMP LOCKOUT

- MBB MAIN BASE BOARD
- MOV METAL OXIDE VARISTOR
- MTR MOTOR
- OAO OUTDOOR AIR QUALITY
- OAT OUTDOOR AIR TEMP. SEN
- OFM OUTDOOR FAN MOTOR
- OFR OUTDOOR FAN RELAY
- OL OVERLOAD
- PER POWER EXHAUST RELAY
- PH PHASE
- PL PLUG ASSEMBLY
- POT POTENTIOMETER
- PMR PHASE MONITOR RELAY
- PS PRESSURE SWITCH
- PWM PULSE WIDTH MODULATION
- QT QUADRUPLE TERMINAL
- RAT THERMOSTAT POWER
- RDV RETURN AIR TEMP. SEN
- RDV REHEAT DISCHARGE VALVE
- RH RELATIVE HUMIDITY
- RLV REHEAT LIQUID VALVE
- RNET LOCAL ACCESS NETWORK
- RVS REVERSING VALVE SOLENOID
- SAT SUPPLY AIR TEMP SENSOR
- SDP SYSTEM DISCHARGE PRESSURE
- SPRH SPACE RELATIVE HUMIDITY
- SPT SPACE TEMPERATURE SENSOR
- SPTO SPACE TEMPERATURE OFFSET
- SSP SYSTEM SUCTION PRESSURE
- SW SWITCH
- TB TERMINAL BLOCK
- TDR TIME DELAY RELAY
- TRAN TRANSFORMER
- UCB UNIT CONTROL BOARD
- W1 1st STAGE OF HEATING CALL
- W2 2nd STAGE OF HEATING CALL
- Y1 1st STAGE OF COOLING CALL
- Y2 2nd STAGE OF COOLING CALL

48TC002789 A

TYPICAL 50GC 04-06 POWER WIRING DIAGRAM, 460-575/3/60 UNIT SHOWN

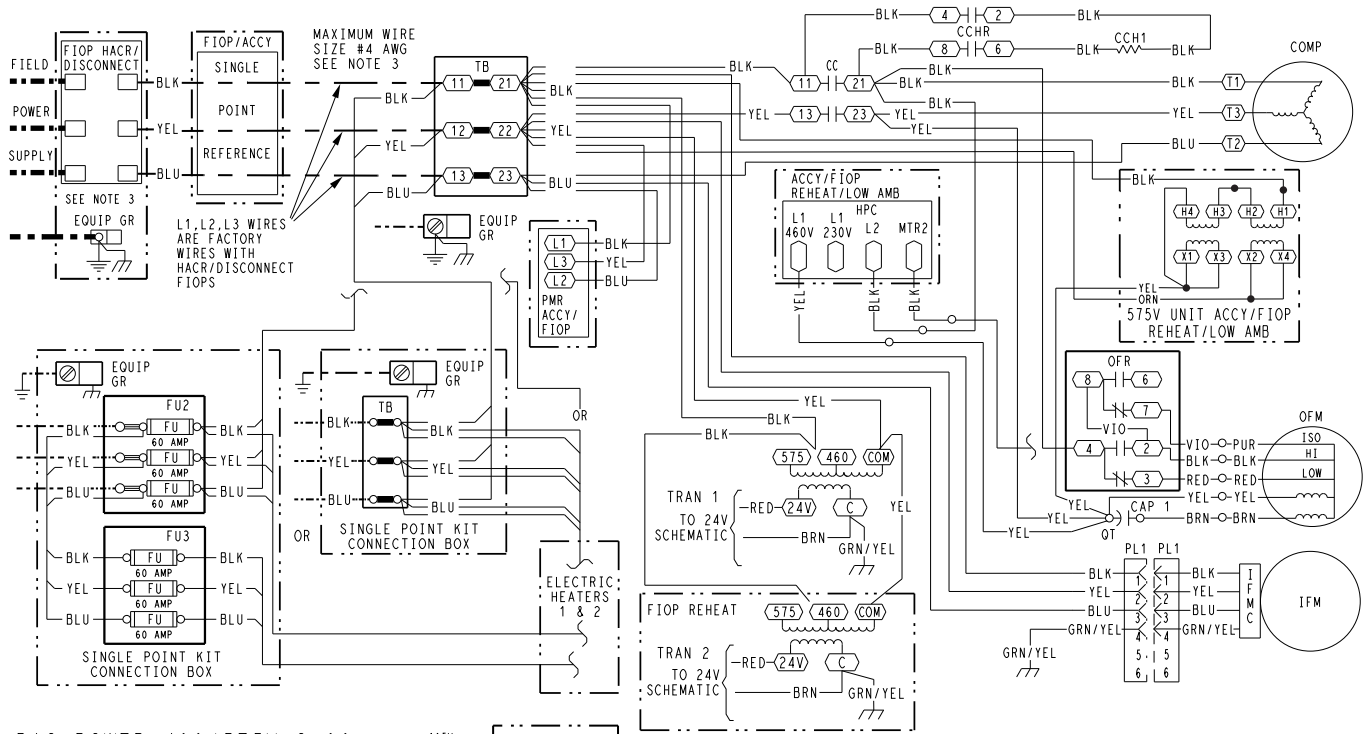

PAC POWER 460/575V-3-60
3-5TON T2

- NOTES**
1. IF ANY OF THE ORIGINAL WIRE FURNISHED MUST BE REPLACED, IT MUST BE REPLACED WITH TYPE 90° C WIRE OR ITS EQUIVALENT.
 2. COMPRESSOR AND FAN MOTORS ARE THERMALLY PROTECTED.
 3. USE COPPER CONDUCTOR ONLY.
 4. DO NOT DISCONNECT POWER PLUG OR SIGNAL WIRE WHILE UNDER LOAD.
 5. TRANSFORMER IS DEDICATED BASED ON UNIT VOLTAGE. TAPS ONLY SHOWN TO SIMPLIFY SCHEMATIC.

LEGEND

- (X) MARKED WIRE
- (X) TERMINAL (MARKED)
- (O) TERMINAL (UNMARKED)
- (●) TERMINAL BLOCK
- (X) SPLICE
- (X) SPLICE (MARKED)
- FACTORY WIRING
- - - FIELD CONTROL WIRING
- - - - - FIELD POWER WIRING
- - - - - CIRCUIT BOARD TRACE
- - - - - ACCESSORY OR OPTIONAL WIRING

ACCY	ACCESSORY	G	GROUND
AWG	AMERICAN WIRE GAGE	GR(ND)	GROUND
BAS	BUILDING AUTOMATION NETWORK	HACR	HEATING, AIR-CONDITIONING, REFRIGERATION BREAKER
CC	CONTACTOR, COMPRESSOR	C	COMMON
C	COMMON	HR	HOT GAS REHEAT
CAP	CAPACITOR	HGRH	HIGH PRESSURE SWITCH
CB	CIRCUIT BREAKER	HPC	HEAD PRESSURE CONTROL
CCH	CRANKCASE HEATER	HPS	HIGH PRESSURE SWITCH
CCHR	CRANKCASE HEATER RELAY	HUM	HUMIDISTAT
CCHTS	CRANKCASE HEATER TEMP SWITCH	IAO	INDOOR AIR QUALITY SENSORS
CLO	COMPRESSOR LOCKOUT	IFM	INDOOR FAN MOTOR
CLV	COOLING LIQUID VALVE	IFMC	INDOOR FAN MOTOR CONTROL
COPF	CONDENSATE OVERFLOW SWITCH	IFO	INDOOR FAN ON SIGNAL
COM	SIGNAL COMMON	IRH	INDOOR RELATIVE HUMIDITY
COMP	COMPRESSOR MOTOR	JMP	JUMPER
DDC	DIRECT DIGITAL CONTROL	L1	LINE 1
DFB	DEFROST BOARD	LA	LOW AMBIENT LOCKOUT
DFT	DEFROST THERMOSTAT	LAR	LOW AMBIENT RELAY
EHR	ELECTRIC HEAT RELAY	LAS	LOW AMBIENT SWITCH
ENTH	ENTHALPY	LDR	COMPRESSOR LOADER
ERV	ENERGY RECOVERY VENTILATOR	LEN	LOCAL EQUIPMENT NETWORK
ESL	ENTHALPY SENSOR - LOW	LOC	LOSS OF CHARGE
FB	FUSE BLOCK	LOOP PWR	CURRENT LOOP POWER
FIOF	FACTORY INSTALLED OPTION	LPS	LOW PRESSURE SWITCH
FPT	FREEZE PROTECTION THERMOSTAT	LS	LIMIT SWITCH
FST	FAN HOUSING TEMP SENSOR	LSM	LIMIT SWITCH (MANUAL RESET)
FU	FUSE	LTLO	LOW TEMP LOCKOUT

MBB	MAIN BASE BOARD	PL1	PLUG ASSEMBLY
MOV	METAL OXIDE VARISTOR	POT	POTENTIOMETER
MTR	MOTOR	PMR	PHASE MONITOR RELAY
OAO	OUTDOOR AIR QUALITY	PS	PRESSURE SWITCH
OAT	OUTDOOR AIR TEMP. SEN	PWM	PULSE WIDTH MODULATION
OFM	OUTDOOR FAN MOTOR	QTR	QUADRUPOLE TERMINAL
OFR	OUTDOOR FAN RELAY	R	THERMOSTAT POWER
OL	OVERLOAD	RAT	RETURN AIR TEMP. SEN
PER	POWER EXHAUST RELAY	RDV	REHEAT DISCHARGE VALVE
PH	PHASE	RLH	RELATIVE HUMIDITY
PL	PLUG ASSEMBLY	RLV	REHEAT LIQUID VALVE
POT	POTENTIOMETER	RNET	LOCAL ACCESS NETWORK
PMR	PHASE MONITOR RELAY	RVS	REVERSING VALVE SOLENOID
PS	PRESSURE SWITCH	SAT	SUPPLY AIR TEMP SENSOR
PWM	PULSE WIDTH MODULATION	SDP	SYSTEM DISCHARGE PRESSURE
QTR	QUADRUPOLE TERMINAL	SPRH	SPACE RELATIVE HUMIDITY
R	THERMOSTAT POWER	SPT	SPACE TEMPERATURE SENSOR
RAT	RETURN AIR TEMP. SEN	SPTO	SPACE TEMPERATURE OFFSET
RDV	REHEAT DISCHARGE VALVE	SSP	SYSTEM SUCTION PRESSURE
RLH	RELATIVE HUMIDITY	SW	SWITCH
RLV	REHEAT LIQUID VALVE	TB	TERMINAL BLOCK
RNET	LOCAL ACCESS NETWORK	TDR	TIME DELAY RELAY
RVS	REVERSING VALVE SOLENOID	TRAN	TRANSFORMER
SAT	SUPPLY AIR TEMP SENSOR	UCB	UNIT CONTROL BOARD
SDP	SYSTEM DISCHARGE PRESSURE	W1	1st STAGE OF HEATING CALL
SPRH	SPACE RELATIVE HUMIDITY	W2	2nd STAGE OF HEATING CALL
SPT	SPACE TEMPERATURE SENSOR	Y1	1st STAGE OF COOLING CALL
SPTO	SPACE TEMPERATURE OFFSET	Y2	2nd STAGE OF COOLING CALL
SSP	SYSTEM SUCTION PRESSURE		

48TC002958 -

General

The sequence below describes the sequence of operation for an electro-mechanical unit with and without a factory-installed EconoMi\$er® IV (W7212 controller) and X (called “economizer” in this sequence) (W7220 controller). For information regarding a direct digital controller, see the start-up, operations, and troubleshooting manual for the applicable controller.

Electro-Mechanical Units with No Economizer

Cooling (two stage units)

When the thermostat calls for cooling, terminals G and Y1 are energized. The indoor fan will run at the low fan speed and the compressor contactor (CC) is energized causing the compressor and outdoor fan to turn on. The low indoor fan speed is 75% of the user set fan speed, the compressor will run at partial capacity, and the outdoor fan will run at low speed.

If additional cooling is needed, the thermostat will add the call for Y2. This will increase the indoor fan speed to the user set fan speed, energize the compressor loader for full compressor capacity, and energize the outdoor fan relay (OFR) for high speed.

When the thermostat removes the call for Y2 but leaves the Y1, the indoor fan will reduce speed to 75% of the user set fan speed, the compressor loader will turn off, and the outdoor fan will drop to low speed. When the thermostat removes the call for Y1 the compressor contactor will de-energize shutting down the compressor and the outdoor fan. When the thermostat removes the call for G, the indoor fan will turn off after the specific unit fan off delay.

Gas Heating (48GC units)

When the thermostat calls for heating, power is sent to W on the Integrated Gas Controller (IGC) board. An LED (light-emitting diode) on the IGC board turns on and remains on during normal operation. A check is made to ensure that the roll-out switch and limit switch are closed. If the check was successful, the induced-draft motor is energized, and when its speed is satisfactory, as proven by the flue gas pressure switch, the ignition activation period begins. The burners will ignite within 5 seconds. If the burners do not light, there is a 22 second delay before another 5-second attempt. This sequence is repeated for 15 minutes or until the burners light. If, after the 15 minutes, the burners still have not lit, heating is locked out. To reset the control, break 24 V power to the thermostat.

When ignition occurs, the IGC board will continue to monitor the condition of the roll-out switch, the limit switches, the flue gas pressure switch, as well as the flame sensor. 45 seconds after ignition occurs, assuming the unit is controlled through a room thermostat set for fan auto, the indoor-fan motor will energize (and the outdoor-air dampers will open to their minimum position). If, for some reason, the over-temperature limit opens prior to the start of the indoor fan blower, the unit will shorten the 45-second delay to 5 seconds less than the time from initiation of heat to when the limit tripped. Gas will not be interrupted to the burners and heating will continue. Once the fan-on delay has been modified, it will not change back to 45 seconds until power is reset to the control. On units with 2 stages of

heat, when additional heat is required, W2 closes and initiates power to the second stage of the main gas valve. When the thermostat is satisfied, W1 and W2 open and the gas valve closes, interrupting the flow of gas to the main burners. If the call for W1 lasted less than 1 minute, the heating cycle will not terminate until 1 minute after W1 became active. If the unit is controlled through a room thermostat set for fan auto, the indoor-fan motor will continue to operate for an additional 45 seconds then stop. If the over-temperature limit opens after the indoor motor is stopped, but within 10 minutes of W1 becoming inactive, on the next cycle the time will be extended by 15 seconds. The maximum delay is 3 minutes. Once modified, the fan off delay will not change back to 45 seconds unless power is reset to the control. A LED indicator is provided on the IGC to monitor operation.

Electric Heating (50GC units)

NOTE: 50GC units are sold as cooling only. If electric heaters are required, use only factory-approved heaters. They will operate as follows.

Units have either 1 or 2 stages of electric heat. When the thermostat calls for heating, power is applied to G and the W1 terminals at the unit. The unit control will energize the indoor fan contactor and the first stage of electric heat. On units with two-stage heating, when additional heating is required, the second stage of electric heat (if equipped) will be energized when power is applied at the W2 terminal on the unit.

IMPORTANT: The thermostat must be configured for Electric Heat so it will energize G with the W1 call.

Electro-mechanical Units with Factory-Installed EconoMi\$er

Cooling

When free cooling is not available, the compressors will be controlled by the zone thermostat. When free cooling is available, the outdoor-air damper is modulated by the EconoMi\$er IV and X control to provide a 50°F (10°C) to 55°F (13°C) mixed-air temperature into the zone. As the mixed air temperature fluctuates above 55°F (13°C) or below 50°F (10°C) dampers will be modulated (open or close) to bring the mixed-air temperature back within control. If mechanical cooling is utilized with free cooling, the outdoor-air damper will maintain its current position at the time the compressor is started. If the increase in cooling capacity causes the mixed-air temperature to drop below 45°F (7°C), then the outdoor-air damper position will be decreased to the minimum position. If the mixed-air temperature continues to fall, the outdoor-air damper will close. Control returns to normal once the mixed-air temperature rises above 48°F (9°C). The power exhaust fans will be energized and de-energized, if installed, as the outdoor-air damper opens and closes.

If field-installed accessory CO₂ sensors are connected to the EconoMi\$er IV and X control, a demand controlled ventilation strategy will begin to operate. As the CO₂ level in the zone increases above the CO₂ set-point, the minimum position of the damper will be increased proportionally. As the CO₂ level decreases because of the increase in

Sequence of operation (cont)



fresh air, the outdoor-air damper will be proportionally closed. For EconoMi\$er IV and X operation, there must be a thermostat call for the fan (G). If the unit is occupied and the fan is on, the damper will operate at minimum position. Otherwise, the damper will be closed.

When the EconoMi\$er IV and X control is in the occupied mode and a call for cooling exists (Y1 on the thermostat), the control will first check for indoor fan operation. If the fan is not on, then cooling will not be activated. If the fan is on, then the control will open the EconoMi\$er IV and X damper to the minimum position.

On the initial power to the EconoMi\$er IV and X control, it will take the damper up to 2¹/₂ minutes before it begins to position itself. After the initial power-up, further changes in damper position can take up to 30 seconds to initiate. Damper movement from full closed to full open (or vice versa) will take between 1¹/₂ and 2¹/₂ minutes. If free cooling can be used as determined from the appropriate changeover command (switch, dry bulb, enthalpy curve, differential dry bulb, or differential enthalpy), then the control will modulate the dampers open to maintain the mixed-air temperature set-point at 50°F (10°C) to 55°F (13°C). If there is a further demand for cooling (cooling second stage — Y2 is energized), then the control will bring on compressor stage 1 to maintain the mixed-air temperature set-point. The EconoMi\$er® IV and X damper will be open at maximum position.

2-Speed Note: When operating in ventilation mode only, the indoor fan motor will automatically adjust to 75% of the total cfm established.

Heating

The sequence of operation for the heating is the same as an electro-mechanical unit with no economizer. The only difference is how the economizer acts. The economizer will stay at the Economizer Minimum Position while the evaporator fan is operating. The outdoor-air damper is closed when the indoor fan is not operating. Refer to Service and Maintenance Manual for further details.

Optional Humidi-MiZer® dehumidification system

Units with the factory equipped Humidi-MiZer system option are capable of providing multiple modes of improved dehumidification as a variation of the normal cooling cycle. The Humidi-MiZer system option includes additional valves in the liquid line and discharge line of each refrigerant circuit, a small reheat condenser coil downstream of the evaporator, and variable-speed control of some or all outdoor fans. Operation of the revised refrigerant circuit for each mode is described below.

The Humidi-MiZer system provides three sub-modes of operation: Cool, Reheat1, and Reheat2.

Cool mode — Provides a normal ratio of Sensible and Latent Cooling effect from the evaporator coil.

Reheat1 — Provides increased Latent Cooling while slightly reducing the Sensible Cooling effect.

Reheat2 — Provides normal Latent Cooling but with null or minimum Sensible Cooling effect delivered to the space.

The Reheat1 and Reheat2 modes are available when the unit is not in a Heating mode and when the Low Ambient Lockout switch is closed.

The figures on this page depict piping for two stage cooling units.

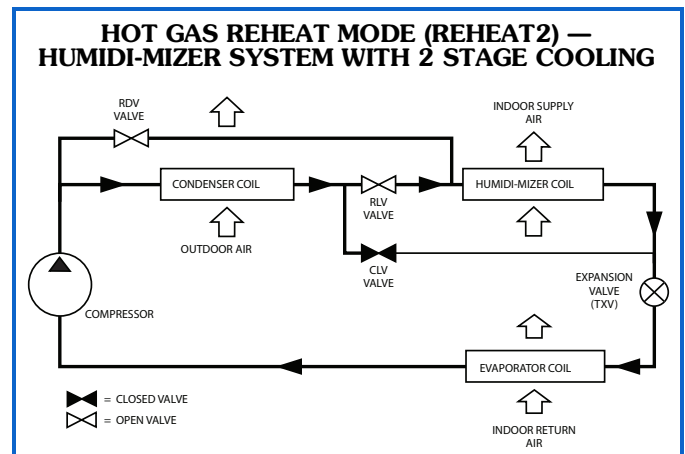
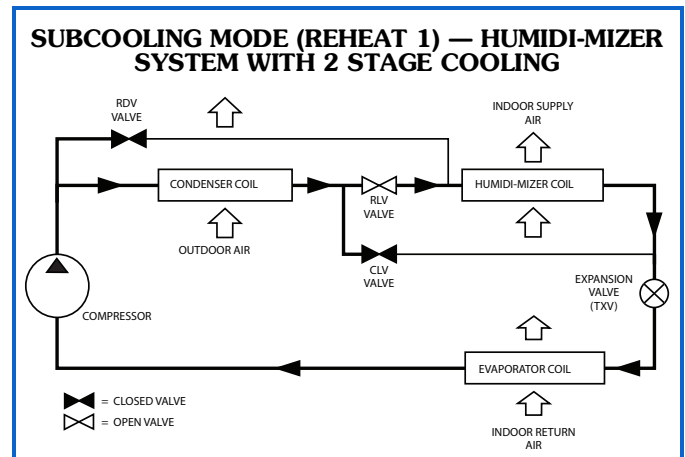
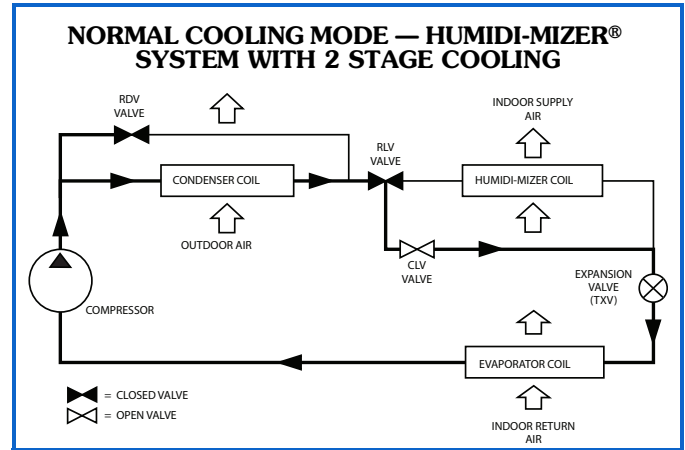

Sequence of operation (cont)



RTU Open controller (factory option)

For details on operating 48/50GC units equipped with the factory-installed RTU Open controller option, refer to Factory Installed RTU Open Multi-Protocol Controller Controls, Start-Up, Operation and Troubleshooting manual.

SystemVu™ controller (factory option)

For details on operating 48/50GC units equipped with the factory-installed SystemVu controller option, refer to FC/GC Series Single Package Rooftop Units with SystemVu Controller Controls, Start-Up, Operation and Troubleshooting manual.

Minimum operating ambient temperature (cooling)

In mechanical cooling mode, your Carrier rooftop unit can safely operate down to an outdoor ambient temperature of 35°F (2°C). It is possible to provide cooling at lower outdoor ambient temperatures by using less outside air, economizers, and/or accessory low ambient kits.

Maximum operating ambient temperature (cooling)

The maximum operating ambient temperature for cooling mode is 125°F (52°C). While cooling operation above 125°F (52°C) may be possible, it could cause either a reduction in performance, reliability, or a protective action by the unit's internal safety devices.

Multiple motor and drive packages

Some applications need larger horsepower motors, some need more airflow, and some need both. Regardless of the case, your Carrier expert has a factory installed combination to meet your application. A wide selection of motors and pulleys (drives) are available, factory installed, to handle nearly any application.

Stainless steel heat exchanger (48GC units only)

The stainless steel heat exchanger option provides the tubular heat exchanger be made out of a minimum 20 gage type 409 stainless steel for applications where the mixed air to the heat exchanger is expected to drop below 45°F (7°C). Stainless steel may be specified on applications where the presence of airborne contaminants require its use (applications such as paper mills) or in area with very high outdoor humidity that may result in severe condensation in the heat exchanger during cooling operation.

Minimum mixed air temperature (heating) (48GC units only)

Using the factory settings, the minimum temperatures for the mixed air (the combined temperature of the warm return air and the cold outdoor air) entering the dimpled, gas heat exchangers are shown in the following table.

MINIMUM TEMPERATURE FOR MIXED AIR TEMPERATURE

ALUMINIZED	STAINLESS STEEL
50°F (10°C) Continuous	40°F (4°C) Continuous
45°F (7°C) Intermittent	35°F (2°C) Intermittent

Operating at lower mixed-air temperatures may be possible, if a field-supplied, outdoor air thermostat initiates both heat stages when the temperature is less than the minimum temperatures listed above. Please contact your local Carrier representative for assistance.

Minimum and maximum airflow (heating and cooling)

To maintain safe and reliable operation of your rooftop, operate within the heating airflow limits during heating mode and cooling airflow limits during cooling mode. Operating above the max may cause blow-off, undesired airflow noise, or airflow related problems with the rooftop unit. Operating below the min may cause problems with coil freeze-up and unsafe heating operation. Heating and cooling limitations differ when evaluating operating CFM, the minimum value is the HIGHER of the cooling and

heating minimum CFM values published on page 8 and the maximum value is the LOWER of the cooling and heating minimum values published on page 8.

Heating-to-cooling changeover

Your unit will automatically change from heating to cooling mode when using a thermostat with an auto-changeover feature.

Airflow

All units are draw-through in cooling mode and blow-through in heating mode.

Outdoor air application strategies

Economizers reduce operating expenses and compressor run time by providing a free source of cooling and a means of ventilation to match application changing needs. In fact, they should be considered for most applications. Also, consider the various economizer control methods and their benefits, as well as sensors required to accomplish your application goals. Please contact your local Carrier representative for assistance.

Motor limits, break horsepower (BHP)

Due to internal design of Carrier units, the air path, and specially designed motors, the full horsepower (maximum continuous BHP) band, as listed in the Fan Performance tables, can be used with the utmost confidence. There is no need for extra safety factors, as Carrier motors are designed and rigorously tested to use the entire, listed BHP range without either nuisance tripping or premature motor failure.

Propane heating (48GC units only)

Propane has different physical qualities than natural gas. As a result, propane requires different fuel to air mixture. To optimize the fuel/air mixture for propane, Carrier sells different burner orifices in an easy to install accessory kit. To select the correct burner orifices or determine the heat capacity for a propane application, use either the selection software, or the unit's service manual.

High altitude heating

High altitudes have less oxygen, which affects the fuel/air mixture in heat exchangers. In order to maintain a proper fuel/air mixture, heat exchangers operating in altitudes above 2000 ft (610 m) require different orifices. To select the correct burner orifices or determine the heat capacity for a high altitude application, use either the selection software, or the unit's service manual.

High altitudes have less oxygen, which means heat exchangers need less fuel. The new gas orifices in this field-installed kit make the necessary adjustment for high altitude applications. They restore the optimal fuel to air mixture and maintain healthy combustion on altitudes above 2000 ft (610 m).

NOTE: Typical natural gas heating value ranges from 975 to 1050 Btu/ft³ at sea level nationally. The heating value goes down approximately 1.7% per every thousand feet elevation. Standard factory orifices can typically be used up to 2000 ft (610 m) elevation without any operational issues.

Sizing a rooftop

Bigger is not necessarily better. While an air conditioner needs to have enough capacity to meet the design loads, it does not need excess capacity. In fact, excess capacity typically results in very poor part load performance and humidity control.

Using higher design temperatures than ASHRAE recommends for your location, adding “safety factors” to the calculated load, are all signs of oversizing air conditioners. Oversizing the air conditioner leads to poor humidity control, reduced efficiency, higher utility bills, larger indoor temperature swings, excessive noise, and increased wear and tear on the air conditioner.

Rather than oversizing an air conditioner, engineers should “right-size” or even slightly “under-size” air conditioners. Correctly sizing an air conditioner controls humidity better; promotes efficiency; reduces utility bills; extends equipment

life, and maintains even, comfortable temperatures. Please contact your local Carrier representative for assistance.

Low ambient applications

The optional Carrier economizer can adequately cool your space by bringing in fresh, cool outside air. In fact, when so equipped, accessory low-ambient kit may not be necessary. In low ambient conditions, unless the outdoor air is excessively humid or contaminated, economizer-based “free cooling” is the preferred less costly and energy conscious method. In low ambient applications where outside air might not be desired (such as contaminated or excessively humid outdoor environments), your Carrier rooftop can operate to ambient temperatures down to -20°F (-29°C) using the recommended accessory low ambient controller.

Two stage cooling operation

Use appropriate two stage thermostat to achieve the unit’s optimum design comfort and overall operating performance.

Note about this specification:

This specification is in the “Masterformat” as published by the Construction Specification Institute. Please feel free to copy this specification directly into your building spec.



High Efficiency Gas Heat/Electric Cooling Packaged Rooftop

HVAC Guide Specifications

Size Range: **3 to 5 Nominal Tons**

Carrier Model Number: **48GC*04-06**

Part 1 — (23 06 80) Schedules for Decentralized HVAC Equipment

1.01 (23 06 80.13) Decentralized Unitary HVAC Equipment Schedule:

- A. 23 06 80.13.A.) Rooftop unit (RTU) schedule:
 - 1. Schedule is per the project specification requirements.

Part 2 — (23 07 16) HVAC equipment insulation

2.01 (23 07 16.13) Decentralized, Rooftop Units:

- A. (23 07 16.13.A.) Evaporator fan compartment:
 - 1. Interior cabinet surfaces shall be insulated with a minimum 1/2-in. thick, minimum 1 1/2-lb density, flexible fiberglass insulation bonded with a phenolic binder, neoprene coated on the air side.
 - 2. Insulation and adhesive shall meet NFPA 90A requirements for flame spread and smoke generation.
- B. (23 07 16.13.B.) Gas Heat Compartment:
 - 1. Aluminum foil-faced fiberglass insulation shall be used.
 - 2. Insulation and adhesive shall meet NFPA 90A requirements for flame spread and smoke generation.

Part 3 — (23 09 13) Instrumentation and control devices for HVAC

3.01 (23 09 13.23) Sensors and Transmitters:

- A. (23 09 13.23.A.) Thermostats:
 - 1. Thermostat must
 - a. energize both “W” and “G” when calling for heat.
 - b. have capability to energize 2 stages of cooling, and 2 different stages of heating.
 - c. include capability for occupancy scheduling.

Part 4 — (23 09 23) Direct Digital Control system for HVAC

4.01 (23 09 23.13) Decentralized, Rooftop Units:

- A. (23 09 23.13.A.) SystemVu™ intelligent integrated Direct Digital Control (DDC) shall provide:
 - 1. Integrated unit operation for comfort cooling, heating ventilation as well as all monitoring,

recording and reporting capabilities. Controller shall also provide diagnostics and alarms of abnormal unit operation through the controller. Controller shall have an intuitive user display and be able to be used in a standalone operation or via building automation system (BAS).

- 2. Quick Unit Status LEDs of: Run – meaning all systems are go, ALERT – that indicates there is currently a non-critical issue with the unit, like filters need to be replaced and FAULT – that indicates the unit has a critical issue and will possibly shut down.
- 3. Six large navigation keys for easy access. Navigation keys shall consist of: TEST, BACK, ENTER, and MENU along with UP and DOWN arrows.
- 4. Full back lit user display with 4 line by 30 character text capabilities. Display menu shall be designed to provide guided major menus and sub menus main menus provided below:
 - a. Shutdown Unit
 - b. Run Status
 - c. Settings
 - d. Alerts/Faults
 - e. Service
 - f. Inputs
 - g. Outputs
 - h. USB
- 5. The capability for standalone operation with conventional thermostat/sensor or use with building automation systems (BAS) of Carrier i-Vu®, BACnet and Carrier Comfort Network® (CCN) systems. No special modules or boards are required for these capabilities. Has the capability to work with Equipment Touch™ and System Touch™ devices and ZS Sensors.
- 6. The ability to read refrigerant pressures at display or via BAS network of; Discharge Pressure and Suction Pressure. The need for traditional refrigerant gages is not required.
- 7. USB Data Port for flash drive interaction. This will allow the transfer of data for uploads, downloads, perform software upgrades, backup and restore data and file transfer data such as component number of starts and run hours.
- 8. Reverse Rotation Protection of compressors if field three phase wiring is misapplied.
- 9. Provide Service Capabilities of:
 - a. Auto run test
 - b. Manual run test
 - c. Component run hours and starts
 - d. Commissioning reports
 - e. Data logging
 - f. Alarm history
- 10. Economizer control and diagnostics. Set up economizer operation, receive feedback from

actuator. Also meets the most recent California Title 24, ASHRAE 90.1 and IECC Fault Detection and Diagnostic (FDD) requirements.

11. Unit cooling operation down to 35°F (2°C).
 12. Controller shall have easy access connections around the controller perimeter area and consist of Mate-N-Lok¹, terminal block and RJ style modular jack connections.
 13. 365 day real time clock, 20 holiday schedules along with occupied and unoccupied scheduling.
 14. Auto-Recognition for easy installation and commissioning of devices like economizers, space sensors etc.
 15. A 5°F temperature difference between cooling and heating set points to meet the latest ASHRAE 90.1 Energy Standard.
 16. Contain return air sensor, supply air sensor and outdoor air sensor to help monitor and provide data for the unit comfort operation, diagnostic and alarms.
 17. Use of Carrier's field accessory hand-held Navigator™ display, Equipment Touch and System Touch devices.
 18. Units with the factory-installed Humidi-MiZer® system option are capable of providing multiple modes of improved dehumidification as a variation of the normal cooling cycle.
 19. Supply Air Tempering control operates the gas or electric heat to maintain a minimum supply air temperature during conditions where very cold outdoor air causes the supply air temperature to fall below the configured Supply Air Tempering Setpoint. This occurs during periods where DCV is active and increasing the amount of outdoor air or in cases where the system is operating at very low airflow and the calculated economizer position has increased to maintain a constant ventilation rate.
 20. Demand limiting in SystemVu™ is achieved through set point expansion. The systems heating and cooling set points are expanded in steps or levels. The degree to which the set points may be expanded is defined by the 6 demand level offsets and the 2 commanded demand limit levels.
 21. 3-year limited part warranty.
- B. (23 09 23.13.B.) RTU Open Protocol, Direct Digital Controller:
1. Shall be ASHRAE 62 compliant.
 2. Shall accept 18 - 30VAC, 50 - 60Hz, and consume 15VA or less power.
 3. Shall have an operating temperature range from -40°F (-40°C) to 130°F (54°C), 10% to 90% RH (non-condensing).

4. Shall include built-in protocol for BACnet² (MS/TP and PTP modes), Modbus³ (RTU and ASCII), Johnson N2 and LonWorks⁴. LonWorks Echelon processor required for all Lon applications shall be contained in separate communication board.
5. Shall allow access of up to 62 network variables (SNVT). Shall be compatible with all open controllers.
6. Baud rate controller shall be selectable using a dipswitch.
7. Shall have an LED display independently showing the status of serial communication, running, errors, power, all digital outputs, and all analog inputs.
8. Shall accept the following inputs: space temperature, setpoint adjustment, outdoor air temperature, indoor air quality, outdoor air quality, compressor lock-out, fire shutdown, enthalpy switch, and fan status/filter status/humidity/remote occupancy.
9. Shall provide the following outputs: economizer, fan, cooling stage 1, cooling stage 2, heat stage 1, heat stage 2, exhaust, reversing valve/high fan speed.
10. Shall have built-in surge protection circuitry through solid-state polyswitches. Polyswitches shall be used on incoming power and network connections. Polyswitches will return to normal when the "trip" condition clears.
11. Shall have a battery back-up capable of a minimum of 10,000 hours of data and time clock retention during power outages.
12. Shall have built-in support for Carrier technician tool.
13. Shall include an RS-485 protocol communication port, an access port for connection of either a computer or a Carrier technician tool, an RS-485 port for network communication to intelligent space sensors and displays, and a port to connect an optional LonWorks communications card.
14. Software upgrades will be accomplished by either local or remote download. No software upgrades through chip replacements are allowed.

Part 5 — (23 09 33) Electric and Electronic Control System for HVAC

5.01 (23 09 33.13) Decentralized, Rooftop Units:

A. (23 09 33.13.A.) General:

1. Shall be complete with self-contained low-voltage control circuit protected by a resettable

2. BACnet is a registered trademark of ASHRAE (American Society of Heating, Refrigerating and Air-Conditioning Engineers).
 3. Modbus is a registered trademark of Schneider Electric.
 4. LonWorks is a registered trademark of Echelon Corporation.

1. Mate-N-Lok is a registered trademark of the Whitaker Corporation.

circuit breaker on the 24-v transformer side. Transformer shall have 75VA capability.

2. Shall utilize color-coded wiring.
 3. Shall include a Unit Control Board to conveniently and safely provide connection points for vital control functions such as: smoke detectors, phase monitor, gas controller, economizer, thermostat, DDC control options, and low and high pressure switches. Controller shall also provide an intuitive means to adjust the indoor fan speed through a simple switch and pot adjustment design.
 4. The heat exchanger shall be controlled by an integrated gas controller (IGC) microprocessor. See heat exchanger section of this specification.
 5. Unit shall include a minimum of one 8-pin screw terminal connection board for connection of control wiring.
- B. (23 09 33.13.B.) Safeties:
1. Compressor over-temperature, over-current. High internal pressure differential.
 2. Low pressure switch.
 - a. Low pressure switch shall use different color wire than the high pressure switch. The purpose is to assist the installer and service technician to correctly wire and or troubleshoot the rooftop unit.
 3. High pressure switch.
 - a. High pressure switch shall use different color wire than the low pressure switch. The purpose is to assist the installer and service technician to correctly wire and or troubleshoot the rooftop unit.
 4. Automatic reset, motor thermal overload protector.
 5. Heating section shall be provided with the following minimum protections:
 - a. High temperature limit switches.
 - b. Induced draft motor speed sensor.
 - c. Flame rollout switch.
 - d. Flame proving controls.

Part 6 — (23 09 93) Sequence of Operations for HVAC Controls

6.01 (23 09 93.13) Decentralized, Rooftop Units:

- A. (23 09 93.13.A.) INSERT SEQUENCE OF OPERATION

Part 7 — (23 40 13) Panel Air Filters

7.01 (23 40 13.13) Decentralized, Rooftop Units:

- A. (23 40 13.13.A.) Standard filter section
1. Shall consist of factory installed, low velocity, disposable 2-in. thick fiberglass filters of commercially available sizes.
 2. Unit shall use only one filter size. Multiple sizes are not acceptable.

3. Filters shall be accessible through an access panel with “no-tool” removal as described in the unit cabinet section of this specification (23 81 19.13.G).

Part 8 — (23 81 19) Self-Contained Air Conditioners

8.01 (23 81 19.13) Small-Capacity Self-Contained Air Conditioners:

A. (23 81 19.13.A.) General:

1. Outdoor, rooftop mounted, electrically controlled, heating and cooling unit utilizing a fully hermetic scroll compressor(s) for cooling duty and gas combustion for heating duty.
2. Factory assembled, single-piece heating and cooling rooftop unit. Contained within the unit enclosure shall be all factory wiring, piping, controls, and special features required prior to field start-up.
3. Unit shall use Puron® (R-410A) refrigerant.
4. Unit shall be installed in accordance with the manufacturer’s instructions.
5. Unit must be selected and installed in compliance with local, state, and federal codes.

B. (23 81 19.13.B.) Quality Assurance:

1. Unit meets and exceeds ASHRAE 90.1 minimum efficiency requirements.
2. Unit shall be rated in accordance with AHRI Standards 210/240.
3. Unit shall be designed to conform to ASHRAE 15.
4. Unit shall be UL-tested and certified in accordance with ANSI Z21.47 Standards and UL-listed and certified under Canadian standards as a total package for safety requirements.
5. Insulation and adhesive shall meet NFPA 90A requirements for flame spread and smoke generation.
6. Unit casing shall be capable of withstanding 500-hour salt spray exposure per ASTM B117 (scribed specimen).
7. Unit shall be designed in accordance with ISO 9001, and shall be manufactured in a facility registered by ISO 9001:2015.
8. Roof curb shall be designed to conform to NRCA Standards.
9. Unit shall be subjected to a completely automated run test on the assembly line. The data for each unit will be stored at the factory, and must be available upon request.
10. Unit shall be designed in accordance with UL Standard 1995, including tested to withstand rain.
11. Unit shall be constructed to prevent intrusion of snow and tested to prevent snow intrusion into the control box up to 40 mph.

12. Unit shake tested to assurance level 1, ASTM D4169 to ensure shipping reliability.
- C. (23 81 19.13.C.) Delivery, Storage, and Handling:
 1. Unit shall be stored and handled per manufacturer's recommendations.
 2. Lifted by crane requires either shipping top panel or spreader bars.
 3. Unit shall only be stored or positioned in the upright position.
- D. (23 81 19.13.D.) Project Conditions:
 1. As specified in the contract.
- E. (23 81 19.13.E.) Operating Characteristics:
 1. Unit shall be capable of starting and running at 125°F (52°C) ambient outdoor temperature, meeting maximum load criteria of AHRI Standard 210/240 at ±10% voltage.
 2. Compressor with standard controls shall be capable of operation down to 35°F (2°C), ambient outdoor temperatures. Accessory winter start kit is necessary if mechanically cooling at ambient temperatures down to 25°F (-4°C).
 3. Unit shall discharge supply air vertically or horizontally as shown on contract drawings.
 4. Unit shall be factory configured for vertical supply and return configurations.
 5. Unit shall be field convertible from vertical to horizontal airflow on all models. No special kit required.
 6. Unit shall be capable of mixed operation: vertical supply with horizontal return or horizontal supply with vertical return.
- F. (23 81 19.13.F.) Electrical Requirements:
 1. Main power supply voltage, phase, and frequency must match those required by the manufacturer.
- G. (23 81 19.13.G.) Unit Cabinet:
 1. Unit cabinet shall be constructed of galvanized steel, and shall be bonderized and coated with a prepainted baked enamel finish on all externally exposed surfaces.
 2. Unit cabinet exterior paint shall be: film thickness, (dry) 0.003-in. minimum, gloss (per ASTM D523, 60°F/16°C): 60, Hardness: H-2H Pencil hardness.
 3. Evaporator fan compartment interior cabinet insulation shall conform to AHRI Standards 210/240 minimum exterior sweat criteria. Interior surfaces shall be insulated with a minimum 1/2-in. thick, 1 lb density, flexible fiberglass insulation, neoprene coated on the air side. Aluminum foil-faced fiberglass insulation shall be used in the gas heat compartment.
 4. Base of unit shall have a minimum of four locations for thru-the-base gas and electrical connections (factory-installed or field-installed), standard.
5. Base Rail:
 - a. Unit shall have base rails on a minimum of 2 sides.
 - b. Holes shall be provided in the base rails for rigging shackles to facilitate maneuvering and overhead rigging.
 - c. Holes shall be provided in the base rail for moving the rooftop by fork truck.
 - d. Base rail shall be a minimum of 16 gage thickness.
6. Condensate pan and connections:
 - a. Shall be a sloped condensate drain pan made of a corrosion resistant material.
 - b. Shall comply with ASHRAE Standard 62.
 - c. Shall use a 3/4-in. 14 NPT drain connection, possible either through the bottom or side of the drain pan. Connection shall be made per manufacturer's recommendations.
7. Top panel:
 - a. Shall be a single piece top panel on all sizes.
8. Gas Connections:
 - a. All gas piping connecting to unit gas valve shall enter the unit cabinet at a single location on side of unit (horizontal plane).
 - b. Thru-the-base capability
 - 1) Standard unit shall have a thru-the-base gas-line location using a raised, embossed portion of the unit basepan.
 - 2) Optional, factory approved, water-tight connection method must be used for thru-the-base gas connections.
 - 3) No basepan penetration, other than those authorized by the manufacturer, is permitted.
9. Electrical Connections:
 - a. All unit power wiring shall enter unit cabinet at a single, factory prepared, knockout location.
 - b. Thru-the-base capability.
 - 1) Standard unit shall have a thru-the-base electrical location(s) using a raised, embossed portion of the unit basepan.
 - 2) Optional, factory approved, water-tight connection method must be used for thru-the-base electrical connections.
 - 3) No basepan penetration, other than those authorized by the manufacturer, is permitted.
10. Component access panels (standard):
 - a. Cabinet panels shall be easily removable for servicing.
 - b. Unit shall have one factory installed, tool-less, removable, filter access panel.
 - c. Panels covering control box, indoor fan, indoor fan motor, gas components (where

applicable), and compressors shall have molded composite handles.

- d. Handles shall be UV modified, composite. They shall be permanently attached, and recessed into the panel.
- e. Screws on the vertical portion of all removable access panel shall engage into heat resistant, molded composite collars.
- f. Collars shall be removable and easily replaceable using manufacturer recommended parts.

H. (23 81 19.13.H.) Gas Heat:

1. General:

- a. Heat exchanger shall be an induced draft design. Positive pressure heat exchanger designs shall not be allowed.
- b. Shall incorporate a direct-spark ignition system and redundant main gas valve.
- c. Gas supply pressure at the inlet to the rooftop unit gas valve must match that required by the manufacturer.

2. The heat exchanger shall be controlled by an integrated gas controller (IGC) microprocessor.

- a. IGC board shall notify users of fault using an LED (light-emitting diode).
- b. The LED shall be visible without removing the control box access panel.
- c. IGC board shall contain algorithms that modify evaporator fan operation to prevent future cycling on high temperature limit switch.
- d. Unit shall be equipped with anti-cycle protection with one short cycle on unit flame rollout switch or 4 continuous short cycles on the high temperature limit switch. Fault indication shall be made using an LED.

3. Standard Heat Exchanger construction

- a. Heat exchanger shall be of the tubular-section type constructed of a minimum of 20-gage steel coated with a nominal 1.2 mil aluminum-silicone alloy for corrosion resistance.
- b. Burners shall be of the in-shot type constructed of aluminum-coated steel.
- c. Burners shall incorporate orifices for rated heat output up to 2000 ft (610 m) elevation. Additional accessory kits may be required for applications above 2000 ft (610 m) elevation, depending on local gas supply conditions.
- d. Each heat exchanger tube shall contain multiple dimples for increased heating effectiveness.

4. Optional Stainless Steel Heat Exchanger construction:

- a. Use energy saving, direct-spark ignition system.
- b. Use a redundant main gas valve.
- c. Burners shall be of the in-shot type constructed of aluminum-coated steel.
- d. All gas piping shall enter the unit cabinet at a single location on side of unit (horizontal plane).
- e. The optional stainless steel heat exchanger shall be of the tubular-section type, constructed of a minimum of 20-gage type 409 stainless steel.
- f. Type 409 stainless steel shall be used in heat exchanger tubes and vestibule plate.
- g. Complete stainless steel heat exchanger allows for greater application flexibility.

5. Optional Low NOx Heat Exchanger construction:

- a. Low NOx reduction shall be provided to reduce nitrous oxide emissions to meet California's Air Quality Management District (SCAQMD) low-NOx emissions requirement of 40 nanograms per joule or less.
- b. Primary tubes and vestibule plates on low NOx units shall be 409 stainless steel. Other components shall be aluminized steel.

6. Induced draft combustion motor and blower:

- a. Shall be a direct-drive, single inlet, forward-curved centrifugal type.
- b. Shall be made from steel with a corrosion resistant finish.
- c. Shall have permanently lubricated sealed bearings.
- d. Shall have inherent thermal overload protection.
- e. Shall have an automatic reset feature.

I. (23 81 19.13.I.) Coils:

1. Standard Aluminum Fin-Copper Tube Coils:

- a. Standard evaporator and condenser coils shall have aluminum lanced plate fins mechanically bonded to seamless internally grooved copper tubes with all joints brazed.
- b. Evaporator coils shall be leak tested to 150 psig, pressure tested to 450 psig, and qualified to UL 1995 burst test at 1775 psig.
- c. Condenser coils shall be leak tested to 150 psig, pressure tested to 650 psig, and qualified to UL 1995 burst test at 1980 psig.

2. Optional Pre-coated aluminum-fin condenser coils (3 Phase Models Only):

- a. Shall have a durable epoxy-phenolic coating to provide protection in mildly corrosive coastal environments.

- b. Coating shall be applied to the aluminum fin stock prior to the fin stamping process to create an inert barrier between the aluminum fin and copper tube.
 - c. Epoxy-phenolic barrier shall minimize galvanic action between dissimilar metals.
 - d. Corrosion durability of fin stock shall be confirmed through testing to be no less than 1000 hours salt spray per ASTM B117-90.
 - e. Corrosion durability of fin stock shall be confirmed through testing to have no visible corrosion after 48 hour immersion in a room temperature solution of 5% salt, 1% acetic acid.
 - f. Fin stock coating shall pass 2000 hours of the following: one week exposure in the prohesion chamber followed by one week of accelerated ultraviolet light testing. Prohesion chamber: the solution shall contain 3.5% sodium chloride and 0.35% ammonium sulfate. The exposure cycle is one hour of salt fog application at ambient followed by one hour drying at 95°F (35°C).
3. Optional Copper-fin evaporator and condenser coils (3 Phase Models Only):
- a. Shall be constructed of copper fins mechanically bonded to copper tubes and copper tube sheets.
 - b. Galvanized steel tube sheets shall not be acceptable.
 - c. A polymer strip shall prevent coil assembly from contacting the sheet metal coil pan to minimize potential for galvanic corrosion between coil and pan.
4. Optional E-coated aluminum-fin evaporator and condenser coils (3 Phase Models Only):
- a. Shall have a flexible epoxy polymer coating uniformly applied to all coil surface areas without material bridging between fins.
 - b. Coating process shall ensure complete coil encapsulation of tubes, fins and headers.
 - c. Color shall be high gloss black with gloss per ASTM D523-89.
 - d. Uniform dry film thickness from 0.8 to 1.2 mil on all surface areas including fin edges.
 - e. Superior hardness characteristics of 2H per ASTM D3363-92A and cross-hatch adhesion of 4B-5B per ASTM D3359-93.
 - f. Impact resistance shall be up to 160 in.-lb (ASTM D2794-93).
 - g. Humidity and water immersion resistance shall be up to minimum 1000 and 250 hours respectively (ASTM D2247-92 and ASTM D870-92).
- h. Corrosion durability shall be confirmed through testing to be no less than 1000 hours salt spray per ASTM B117-90.
- J. (23 81 19.13.J.) Refrigerant Components:
1. Refrigerant circuit shall include the following control, safety, and maintenance features:
 - a. TXV metering system on all models shall include a multiple feed distribution system that optimizes coil performance.
 - b. Refrigerant filter drier - Solid core design.
 - c. Service gage connections on suction and discharge lines.
 - d. Pressure gage access through a specially designed access port in the top panel of the unit.
 2. There shall be gage line access port in the skin of the rooftop, covered by a black, removable plug.
 - a. The plug shall be easy to remove and replace.
 - b. When the plug is removed, the gage access port shall enable maintenance personnel to route their pressure gage lines.
 - c. This gage access port shall facilitate correct and accurate condenser pressure readings by enabling the reading with the compressor access panel on.
 - d. The plug shall be made of a leak proof, UV-resistant, composite material.
 3. Compressors:
 - a. Unit shall use fully hermetic, two stage scroll compressor on a single refrigeration circuit.
 - b. Compressor motors shall be cooled by refrigerant gas passing through motor windings.
 - c. Compressors shall be internally protected from high discharge temperature conditions.
 - d. Compressors shall be protected from an over-temperature and over-ampereage conditions by an internal, motor overload device.
 - e. Compressor shall be factory mounted on rubber grommets.
 - f. Compressor motors shall have internal line break thermal, current overload and high pressure differential protection.
 - g. Crankcase heaters shall not be required for normal operating range, unless required by compressor manufacturer due to refrigerant charge limits.
- K. (23 81 19.13.K.) Filter Section:
1. Filters access is specified in the unit cabinet section of this specification.
 2. Filters shall be held in place by a pivoting filter tray, facilitating easy removal and installation.

3. Shall consist of factory installed, low velocity, throw-away 2-in. thick fiberglass filters.
 4. Filters shall be standard, commercially available sizes.
 5. Only one size filter per unit is allowed.
- L. (23 81 19.13.L.) Evaporator Fan and Motor with EcoBlue™ Technology:
1. Direct Drive Evaporator fan motor:
 - a. Shall be a ECM motor design.
 - b. Shall have permanently lubricated bearings.
 - c. Shall have inherent automatic-reset thermal overload protection.
 - d. Shall have slow ramp up to speed capabilities.
 - e. Shall require no fan/motor belts for operation, adjustments and or initial fan speed set up.
 - f. Fan DC voltage set up on Unit Control Board can eliminate the need of removal of blower access door, required on conventional belt drive systems.
 - g. Shall be internally protected from electrical phase reversal and loss.
 2. Evaporator Fan:
 - a. Shall be easily set with selection switch and adjustment pot on unit control board or through SystemVu™ controller.
 - b. On all sizes 04-06 which have two stage cooling capacity control, the indoor fan speed is automatically controlled to meet the AHRI performance requirement with 75% low fan speed and 100% at full fan speed operation
 - c. Blower fan shall be a Vane Axial fan design with 75% less moving parts than a conventional belt drive system.
 - d. Shall be constructed of a cast aluminum stator and high impact composite material on rotor and air inlet casing.
 - e. Shall be a patented / pending design with a corrosion resistant material and dynamically balanced.
 - f. Shall have slow ramp up to speed capabilities to help reduce sound and comfort issues typically associated with single speed belt drive systems.
 - g. Shall be a slide out design with two screw removal.
 3. Shall include an easily accessible unit Control Board to conveniently and safely provide connection points for vital control functions such as: smoke detectors, phase monitor, gas controller, economizer, thermostat, DDC control options, and low and high pressure switches. Controller shall also provide an intuitive means to adjust the indoor fan speed through a simple switch and pot adjustment design.
- M. (23 81 19.13.M.) Condenser Fans and Motors:
1. Condenser fan motors:
 - a. Shall be a totally enclosed motor.
 - b. Shall use permanently lubricated bearings.
 - c. Shall have inherent thermal overload protection with an automatic reset feature.
 - d. Shall use a shaft-down design on all sizes.
 2. Condenser Fans:
 - a. Shall be a direct-driven propeller type fan constructed of high impact composite material.
 - b. Shall have high impact composite blades completely formed into one piece without blade fasteners or connectors and shall be dynamically balanced.
- N. (23 81 19.13.N.) Special Features Options and Accessories:
1. Integrated EconoMi\$er® IV, EconoMi\$er2, and EconoMi\$er X low leak rate models. (EconoMi\$er2, and EconoMi\$er X are factory-installed on 3 phase models only. All are field-installed on all 3 and 1 phase models.)
 - a. Integrated, gear driven opposing modulating blade design type capable of simultaneous economizer and compressor operation.
 - b. Independent modules for vertical or horizontal return configuration shall be available. Vertical return modules shall be available as a factory installed option.
 - c. Damper blades shall be galvanized steel with composite gears. Plastic or composite blades on intake or return shall not be acceptable.
 - d. Shall include all hardware and controls to provide free cooling with outdoor air when temperature and/or humidity are below setpoints.
 - e. Shall be equipped with gear driven dampers for both the outdoor ventilation air and the return air for positive air stream control.
 - f. Standard leak rate shall be equipped with dampers not to exceed 2% leakage at 1 in. wg pressure differential.
 - g. Economizer controller on EconoMi\$er IV (field-installed only) models shall be Honeywell W7212 that provides:
 - 1) Combined minimum and DCV maximum damper position potentiometers with compressor staging relay.
 - 2) Functions with solid-state analog enthalpy or dry bulb changeover control sensing.
 - 3) Contain LED indicates for: when free cooling is available, when module is in

- DCV mode, when exhaust fan contact is closed.
- h. Economizer controller on EconoMi\$er X models shall be the Honeywell W7220 that provides:
 - 1) 2-line LCD interface screen for setup, configuration and troubleshooting.
 - 2) On-board Fault Detection and Diagnostics (FDD) that senses and alerts when the economizer is not operating properly, per California Title 24, ASHRAE 90.1 and IECC.
 - 3) Sensor failure loss of communication identification.
 - 4) Automatic sensor detection.
 - 5) Capabilities for use with multiple-speed or single speed indoor fan systems.
 - 6) Utilize digital sensors: Dry bulb and Enthalpy.
 - i. Economizer controller on EconoMi\$er 2 models with RTU Open or SystemVu controllers shall be a 4 to 20mA design controlled directly by the controller. RTU Open and SystemVu meet California Title 24, ASHRAE 90.1 and IECC Fault Detection and Diagnostic (FDD) requirements.
 - j. Shall be capable of introducing up to 100% outdoor air.
 - k. Shall be equipped with a barometric relief damper capable of relieving up to 100% return air and contain seals that meet ASHRAE 90.1 requirements.
 - l. Shall be designed to close damper(s) during loss-of-power situations with spring return built into motor.
 - m. Dry bulb outdoor air temperature sensor shall be provided as standard. Enthalpy sensor is also available on factory-installed economizers only. Outdoor air sensor setpoint shall be adjustable and shall range from 40°F to 100°F (4°C to 38°C). Additional sensor options shall be available as accessories.
 - n. The economizer controller shall also provide control of an accessory power exhaust unit function. Factory set at 100%, with a range of 0% to 100%.
 - o. The economizer shall maintain minimum air-flow into the building during occupied period and provide design ventilation rate for full occupancy.
 - p. Dampers shall be completely closed when the unit is in the unoccupied mode.
 - q. Economizer controller shall accept a 2 to 10 vdc CO₂ sensor input for IAQ/DCV control. In this mode, dampers shall modulate the outdoor air damper to provide ventilation based on the sensor input.
 - r. Compressor lockout temperature on W7220 control is adjustable from -45°F to 80°F, set at a factory default of 32°F. W7212 control opens at 35°F (2°C) and closes at 50°F (10°C).
 - s. Actuator shall be direct coupled to economizer gear. No linkage arms or control rods shall be acceptable.
 - t. Economizer controller shall provide indications when in free cooling mode, in the DCV mode, or the exhaust fan contact is closed.
- 2. Integrated EconoMi\$er®2, and EconoMi\$er X Ultra Low Leak rate models. (Factory installed on 3 phase models only. Field installed on all 3 and 1 phase models.)
 - a. Integrated, gear driven opposing modulating blade design type capable of simultaneous economizer and compressor operation.
 - b. Independent modules for vertical or horizontal return configuration shall be available. Vertical return modules shall be available as a factory installed option.
 - c. Damper blades shall be galvanized steel with composite gears. Plastic or composite blades on intake or return shall not be acceptable.
 - d. Shall include all hardware and controls to provide free cooling with outdoor air when temperature and/or humidity are below set-points.
 - e. Shall be equipped with gear driven dampers for both the outdoor ventilation air and the return air for positive air stream control.
 - f. Ultra Low Leak design meets California Title 24 section 140.4 and ASHRAE 90.1 requirements for 4 cfm per sq. ft. on the outside air dampers and 10 cfm per sq. ft. on the return dampers.
 - g. Economizer controller on EconoMi\$er X models shall be the Honeywell W7220 that provides:
 - 1) 2-line LCD interface screen for setup, configuration and troubleshooting.
 - 2) On-board Fault Detection and Diagnostics (FDD) that senses and alerts when the economizer is not operating properly, per California Title 24, ASHRAE 90.1 and IECC¹.
 - 3) Sensor failure loss of communication identification.
 - 4) Automatic sensor detection.
 - 5) Capabilities for use with multiple-speed indoor fan systems.
 - 6) Utilize digital sensors: Dry bulb and Enthalpy.

1. IECC is a registered trademark of the International Code Council, Inc.

- h. Economizer controller on EconoMi\$er 2 models with RTU Open or SystemVu™ controls shall be a 4-20mA design controlled directly by the controller. RTU Open and SystemVu meet California Title 24, ASHRAE 90.1 and IECC Fault Detection and Diagnostic (FDD) requirements.
 - i. Shall be capable of introducing up to 100% outdoor air.
 - j. Shall be equipped with a barometric relief damper capable of relieving up to 100% return air and contain seals that meet ASHRAE 90.1 requirements.
 - k. Shall be designed to close damper(s) during loss-of-power situations with spring return built into motor.
 - l. Dry bulb outdoor air temperature sensor shall be provided as standard. Enthalpy sensor is also available on factory-installed economizers only. Outdoor air sensor setpoint shall be adjustable and shall range from 40°F to 100° F (4°C to 38°C). Additional sensor options shall be available as accessories.
 - m. The economizer controller shall also provide control of an accessory power exhaust unit function. Factory set at 100%, with a range of 0% to 100%.
 - n. The economizer shall maintain minimum air-flow into the building during occupied period and provide design ventilation rate for full occupancy.
 - o. Dampers shall be completely closed when the unit is in the unoccupied mode.
 - p. Economizer controller shall accept a 2 to 10 vdc CO₂ sensor input for IAQ/DCV control. In this mode, dampers shall modulate the outdoor air damper to provide ventilation based on the sensor input.
 - q. Compressor lockout temperature on W7220 control is adjustable from -45°F to 80°F, set at a factory default of 32°F. W7212 control opens at 35°F (2°C) and closes at 50°F (10°C).
 - r. Actuator shall be direct coupled to economizer gear. No linkage arms or control rods shall be acceptable.
 - s. Economizer controller shall provide indications when in free cooling mode, in the DCV mode, or the exhaust fan contact is closed.
3. Two-Position Damper (field-installed only):
 - a. Damper shall be a Two-Position Damper. Damper travel shall be from the full closed position to the field adjustable %-open setpoint.
 - b. Damper shall include adjustable damper travel from 25% to 100% (full open).
 - c. Damper shall include single or dual blade, gear driven dampers and actuator motor.
 - d. Actuator shall be direct coupled to damper gear. No linkage arms or control rods shall be acceptable.
 - e. Damper will admit up to 100% outdoor air for applicable rooftop units.
 - f. Damper shall close upon indoor (evaporator) fan shutoff and/or loss of power.
 - g. The damper actuator shall plug into the rooftop unit's wiring harness plug. No hard wiring shall be required.
 - h. Outside air hood shall include aluminum water entrainment filter.
4. Manual damper (field-installed only):
 - a. Manual damper package shall consist of damper, air inlet screen, and rain hood which can be preset to admit up to 25% or 50% outdoor air for year round ventilation.
 5. Humidi-MiZer® Adaptive Dehumidification System (3 Phase Models Only):
 - a. The Humidi-MiZer Adaptive Dehumidification System shall be factory installed and shall provide greater dehumidification of the occupied space by two modes of dehumidification operations in addition to its normal design cooling mode:
 - 1) Subcooling mode further sub cools the hot liquid refrigerant leaving the condenser coil when both temperature and humidity in the space are not satisfied.
 - 2) Hot gas reheat mode shall mix a portion of the hot gas from the discharge of the compressor with the hot liquid refrigerant leaving the condenser coil to create a two-phase heat transfer in the system, resulting in a neutral leaving air temperature when only humidity in the space is not satisfied.
 - 3) Includes low ambient controller.
 6. Low Ambient Control Package:
 - a. Controller shall control coil head pressure by condenser fan speed modulation or condenser fan cycling and wind baffles.
 - b. Shall consist of solid-state control and condenser coil temperature sensor to maintain condensing temperature between 90°F (32°C) and 110°F (43°C) at outdoor ambient temperatures down to -20°F (-29°C).
 7. Propane Conversion Kit:
 - a. Package shall contain all the necessary hardware and instructions to convert a standard natural gas unit for use with liquefied propane, up to 2000 ft (610 m) elevation.
 - b. Additional accessory kits may be required for applications above 2000 ft (610 m) elevation.

8. Flue Shield:
 - a. Flue shield shall provide protection from the hot sides of the gas flue hood.
9. Condenser Coil Hail Guard Assembly (Factory-installed on 3 Phase Models Only. Field-installed on all 3 and 1 Phase Models.)
 - a. Shall protect against damage from hail.
 - b. Shall be either hood style or louvered.
10. Unit-Mounted, Non-Fused Disconnect Switch (Available on units with MOCPs of 80 amps or less):
 - a. Switch shall be factory installed, internally mounted.
 - b. National Electric Code (NEC) and UL approved non-fused switch shall provide unit power shutoff.
 - c. Shall be accessible from outside the unit.
 - d. Shall provide local shutdown and lockout capability.
 - e. Sized only for the unit as ordered from the factory. Does not accommodate field-installed devices.
11. HACR Breaker:
 - a. These manual reset devices provide overload and short circuit protection for the unit. Factory wired and mounted with the units, with access cover to help provide environmental protection. On 575V applications, HACR breaker can only be used with WYE power distribution systems. Use on Delta power distribution systems is prohibited.
 - b. Sized only for the unit as ordered from the factory. Does not accommodate field-installed devices.
12. Convenience Outlet:
 - a. Powered convenience outlet. (3 Phase Models Only)
 - 1) Outlet shall be powered from main line power to the rooftop unit.
 - 2) Outlet shall be powered from line side or load side of disconnect by installing contractor, as required by code. If outlet is powered from load side of disconnect, unit electrical ratings shall be UL certified and rated for additional outlet amperage.
 - 3) Outlet shall be factory-installed and internally mounted with easily accessible 115-v female receptacle.
 - 4) Outlet shall include 15 amp GFI receptacles with independent fuse protection.
 - 5) Voltage required to operate convenience outlet shall be provided by a factory installed step-down transformer.
 - 6) Outlet shall be accessible from outside the unit.
- 7) Outlet shall include a field installed “Wet in Use” cover.
- b. Factory-Installed Non-Powered convenience outlet.
 - 1) Outlet shall be powered from a separate 115/120v power source.
 - 2) A transformer shall not be included.
 - 3) Outlet shall be factory-installed and internally mounted with easily accessible 115-v female receptacle.
 - 4) Outlet shall include 15 amp GFI receptacles with independent fuse protection.
 - 5) Outlet shall be accessible from outside the unit.
 - 6) Outlet shall include a field installed “Wet in Use” cover.
- c. Field-Installed Non-Powered convenience outlet.
 - 1) Outlet shall be powered from a separate 115/120v power source.
 - 2) A transformer shall not be included.
 - 3) Outlet shall be field-installed and internally mounted with easily accessible 115-v female receptacle.
 - 4) Outlet shall include 20 amp GFI receptacles. This kit provides a flexible installation method which allows code compliance for height requirements of the GFCI outlet from the finished roof surface as well as the capability to relocate the outlet to a more convenient location.
 - 5) Outlet shall be accessible from outside the unit.
 - 6) Outlet shall include a field installed “Wet in Use” cover.
13. Flue Discharge Deflector:
 - a. Flue discharge deflector shall direct unit exhaust vertically instead of horizontally.
 - b. Deflector shall be defined as a “natural draft” device by the National Fuel and Gas (NFG) code.
14. Thru-the-Base Connectors:
 - a. Kits shall provide connectors to permit gas and electrical connections to be brought to the unit through the unit basepan.
 - b. Minimum of four connection locations per unit.
15. Propeller Power Exhaust:
 - a. Power exhaust shall be used in conjunction with an integrated economizer.
 - b. Independent modules for vertical or horizontal return configurations shall be available.
 - c. Horizontal power exhaust is shall be mounted in return ductwork.
 - d. Power exhaust shall be controlled by economizer controller operation. Exhaust fans

shall be energized when dampers open past the 0 to 100% adjustable setpoint on the economizer control.

16. Roof Curbs (Vertical):
 - a. Full perimeter roof curb with exhaust capability providing separate air streams for energy recovery from the exhaust air without supply air contamination.
 - b. Formed galvanized steel with wood nailer strip and shall be capable of supporting entire unit weight.
 - c. Permits installation and securing of ductwork to curb prior to mounting unit on the curb.
17. High Altitude Gas Conversion Kit:
 - a. Package shall contain all the necessary hardware and instructions to convert a standard natural gas unit to operate from 2000 to 7000 ft (610 to 2134 m) elevation with natural gas or from 0 to 7000 ft (0 to 2134 m) elevation with liquefied propane.
18. Outdoor Air Enthalpy Sensor:
 - a. The outdoor air enthalpy sensor shall be used to provide single enthalpy control. When used in conjunction with a return air enthalpy sensor, the unit will provide differential enthalpy control. The sensor allows the unit to determine if outside air is suitable for free cooling.
19. Return Air Enthalpy Sensor:
 - a. The return air enthalpy sensor shall be used in conjunction with an outdoor air enthalpy sensor to provide differential enthalpy control.
20. Indoor Air Quality (CO₂) Sensor:
 - a. Shall be able to provide demand ventilation indoor air quality (IAQ) control.
 - b. The IAQ sensor shall be available in duct mount, wall mount, or wall mount with LED display. The setpoint shall have adjustment capability.
21. Smoke detectors (factory-installed only):
 - a. Shall be a four-wire controller and detector.
 - b. Shall be environmental compensated with differential sensing for reliable, stable, and drift-free sensitivity.
 - c. Shall use magnet-activated test/reset sensor switches.
 - d. Shall have tool-less connection terminal access.
 - e. Shall have a recessed momentary switch for testing and resetting the detector.
 - f. Controller shall include:
 - 1) One set of normally open alarm initiation contacts for connection to an initiating device circuit on a fire alarm control panel.
22. Winter Start Kit:
 - a. Shall contain a bypass device around the low pressure switch.
 - b. Shall be required when mechanical cooling is required down to 25°F (-4°C).
 - c. Shall not be required to operate on an economizer when below an outdoor ambient of 35°F (2°C).
23. Time Guard:
 - a. Shall prevent compressor short-cycling by providing a 5 minute delay (±2 minutes) before restarting a compressor after shut-down for any reason.
 - b. One device shall be required per compressor.
24. Hinged Access Panels:
 - a. Shall provide easy access through integrated quarter turn latches.
 - b. Shall be on major panels of: filter, control box, fan motor, and compressor.
25. Condensate overflow switch:
 - a. This sensor and related controller monitors the condensate level in the drain pan and shuts down compression operation when overflow conditions occur. It includes:
 - 1) Indicator light — solid red (more than 10 seconds on water contact – compressors disabled), blinking red (sensor disconnected).
 - 2) 10 second delay to break — eliminates nuisance trips from splashing or waves in pan (sensor needs 10 seconds of constant water contact before tripping).
 - 3) Disables the compressor(s) operation when condensate plug is detected, but still allows fans to run for economizer.
26. Foil Faced Insulation:
 - a. Throughout unit cabinet air stream, non-fibrous and cleanable foil faced insulation is used.
27. MERV-8 Return Air filters:
 - a. Factory option to upgrade standard unit filters to MERV-8 filters.

28. Phase Monitor Control:

- a. Shall monitor the sequence of three phase electrical system to provide a phase reversal protection.
- b. Shall monitor the three phase voltage inputs to provide a phase loss protection for the three phase device.
- c. Will work on either a Delta or Wye power connection.

29. Horn/Strobe Annunciator:

- a. Provides an audible/visual signaling device for use with factory-installed option or field installed accessory smoke detectors.
 - 1) Requires installation of a field-supplied 24-v transformer suitable for 4.2 VA (AC) or 3.0 VA (DC) per horn/strobe accessory.
 - 2) Requires field-supplied electrical box, North American 1-gang box, 2-in. (51 mm) x 4-in. (102 mm).
 - 3) Shall have a clear colored lens.

Note about this specification:

This specification is in the “Masterformat” as published by the Construction Specification Institute. Please feel free to copy this specification directly into your building spec.



High Efficiency Cooling Only/Electric Heat Packaged Rooftop

HVAC Guide Specifications

Size Range: **3 to 5 Nominal Tons**

Carrier Model Number: **50GC*04-06**

Part 1 — (23 06 80) Schedules for Decentralized HVAC Equipment

1.01 (23 06 80.13) Decentralized Unitary HVAC Equipment Schedule:

- A. (23 06 80.13.A.) Rooftop unit (RTU) schedule:
 - 1. Schedule is per the project specification requirements.

Part 2 — (23 07 16) HVAC equipment insulation

2.01 (23 07 16.13) Decentralized, Rooftop Units:

- A. (23 07 16.13.A.) Evaporator fan compartment:
 - 1. Interior cabinet surfaces shall be insulated with a minimum 1/2-in. thick, minimum 1 1/2 lb density, flexible fiberglass insulation bonded with a phenolic binder, neoprene coated on the air side.
 - 2. Insulation and adhesive shall meet NFPA 90A requirements for flame spread and smoke generation.
- B. (23 07 16.13.B.) Electric Heat Compartment:
 - 1. Aluminum foil-faced fiberglass insulation shall be used.
 - 2. Insulation and adhesive shall meet NFPA 90A requirements for flame spread and smoke generation.

Part 3 — (23 09 13) Instrumentation and control devices for HVAC

3.01 (23 09 13.23) Sensors and Transmitters:

- A. (23 09 13.23.A.) Thermostats:
 - 1. Thermostat must
 - a. energize both “W” and “G” when calling for heat.
 - b. have capability to energize 2 stages of cooling, and 2 different stages of heating.
 - c. include capability for occupancy scheduling.

Part 4 — (23 09 23) Direct Digital Control system for HVAC

4.01 (23 09 23.13) Decentralized, Rooftop Units:

- A. (23 09 23.13.A.) SystemVu™ intelligent integrated Direct Digital Control (DDC) shall provide:
 - 1. Integrated unit operation for comfort cooling, heating ventilation as well as all monitoring,

recording and reporting capabilities. Controller shall also provide diagnostics and alarms of abnormal unit operation through the controller. Controller shall have an intuitive user display and be able to be used in a standalone operation or via building automation system (BAS).

- 2. Quick Unit Status LEDs of: Run – meaning all systems are go, ALERT – that indicates there is currently a non-critical issue with the unit, like filters need to be replaced and FAULT – that indicates the unit has a critical issue and will possibly shut down.
- 3. Six large navigation keys for easy access. Navigation keys shall consist of: TEST, BACK, ENTER, and MENU along with UP and DOWN arrows.
- 4. Full back lit user display with 4 line by 30 character text capabilities. Display menu shall be designed to provide guided major menus and sub menus main menus provided below:
 - a. Shutdown Unit
 - b. Run Status
 - c. Settings
 - d. Alerts/Faults
 - e. Service
 - f. Inputs
 - g. Outputs
 - h. USB
- 5. The capability for standalone operation with conventional thermostat/sensor or use with building automation systems (BAS) of Carrier i-Vu®, BACnet and Carrier Comfort Network® (CCN) systems. No special modules or boards are required for these capabilities. Has the capability to work with Equipment Touch™ and System Touch™ devices and ZS Sensors.
- 6. The ability to read refrigerant pressures at display or via BAS network of; Discharge Pressure and Suction Pressure. The need for traditional refrigerant gages is not required.
- 7. USB Data Port for flash drive interaction. This will allow the transfer of data for uploads, downloads, perform software upgrades, backup and restore data and file transfer data such as component number of starts and run hours.
- 8. Reverse Rotation Protection of compressors if field three phase wiring is misapplied.
- 9. Provide Service Capabilities of:
 - a. Auto run test
 - b. Manual run test
 - c. Component run hours and starts
 - d. Commissioning reports
 - e. Data logging
 - f. Alarm history

10. Economizer control and diagnostics. Set up economizer operation, receive feedback from actuator. Also meets the most recent California Title 24, ASHRAE 90.1 and IECC Fault Detection and Diagnostic (FDD) requirements.
 11. Unit cooling operation down to 35°F (2°C).
 12. Controller shall have easy access connections around the controller perimeter area and consist of Mate-N-Lok¹, terminal block and RJ style modular jack connections.
 13. 365 day real time clock, 20 holiday schedules along with occupied and unoccupied scheduling.
 14. Auto-Recognition for easy installation and commissioning of devices like economizers, space sensors etc.
 15. A 5°F temperature difference between cooling and heating set points to meet the latest ASHRAE 90.1 Energy Standard.
 16. Contain return air sensor, supply air sensor and outdoor air sensor to help monitor and provide data for the unit comfort operation, diagnostic and alarms.
 17. Use of Carrier's field accessory hand-held Navigator™ display, Equipment Touch and System Touch devices.
 18. Units with the factory-installed Humidi-MiZer® system option are capable of providing multiple modes of improved dehumidification as a variation of the normal cooling cycle.
 19. Supply Air Tempering control operates the gas or electric heat to maintain a minimum supply air temperature during conditions where very cold outdoor air causes the supply air temperature to fall below the configured Supply Air Tempering Setpoint. This occurs during periods where DCV is active and increasing the amount of outdoor air or in cases where the system is operating at very low airflow and the calculated economizer position has increased to maintain a constant ventilation rate.
 20. Demand limiting in SystemVu™ is achieved through set point expansion. The systems heating and cooling set points are expanded in steps or levels. The degree to which the set points may be expanded is defined by the 6 demand level offsets and the 2 commanded demand limit levels.
 21. 3-year limited part warranty.
- B. (23 09 23.13.B.) RTU Open Protocol, Direct Digital Controller:
1. Shall be ASHRAE 62 compliant.
 2. Shall accept 18 - 30VAC, 50 - 60Hz, and consumer 15VA or less power.
 3. Shall have an operating temperature range from -40°F (-40°C) to 130°F (54°C), 10% to 90% RH (non-condensing).
 4. Shall include built-in protocol for BACnet² (MS/TP and PTP modes), Modbus³ (RTU and ASCII), Johnson N2 and LonWorks⁴. LonWorks Echelon processor required for all Lon applications shall be contained in separate communication board.
 5. Shall allow access of up to 62 network variables (SNVT). Shall be compatible with all open controllers.
 6. Baud rate controller shall be selectable using a dipswitch.
 7. Shall have an LED display independently showing the status of serial communication, running, errors, power, all digital outputs, and all analog inputs.
 8. Shall accept the following inputs: space temperature, setpoint adjustment, outdoor air temperature, indoor air quality, outdoor air quality, compressor lock-out, fire shutdown, enthalpy switch, and fan status/filter status/humidity/remote occupancy.
 9. Shall provide the following outputs: economizer, fan, cooling stage 1, cooling stage 2, heat stage 1, heat stage 2, exhaust, reversing valve/high fan speed.
 10. Shall have built-in surge protection circuitry through solid-state polyswitches. Polyswitches shall be used on incoming power and network connections. Polyswitches will return to normal when the "trip" condition clears.
 11. Shall have a battery back-up capable of a minimum of 10,000 hours of data and time clock retention during power outages.
 12. Shall have built-in support for Carrier technician tool.
 13. Shall include an RS-485 protocol communication port, an access port for connection of either a computer or a Carrier technician tool, an RS-485 port for network communication to intelligent space sensors and displays, and a port to connect an optional LonWorks communications card.
 14. Software upgrades will be accomplished by either local or remote download. No software upgrades through chip replacements are allowed.

1. Mate-N-Lok is a registered trademark of the Whitaker Corporation.

2. BACnet is a registered trademark of ASHRAE (American Society of Heating, Refrigerating and Air-Conditioning Engineers).
3. Modbus is a registered trademark of Schneider Electric.
4. LonWorks is a registered trademark of Echelon Corporation.

Part 5 — (23 09 33) Electric and Electronic Control System for HVAC

6.01 (23 09 33.13) Decentralized, Rooftop Units:

A. (23 09 33.13.A.) General:

1. Shall be complete with self-contained low-voltage control circuit protected by a resettable circuit breaker on the 24-v transformer side. Transformer shall have 75VA capability.
2. Shall utilize color-coded wiring.
3. Shall include a Unit Control Board to conveniently and safely provide connection points for vital control functions such as: smoke detectors, phase monitor, economizer, thermostat, DDC control options, and low and high pressure switches. Controller shall also provide an intuitive means to adjust the indoor fan speed through a simple switch and pot adjustment design.
4. Unit shall include a minimum of one 8-pin screw terminal connection board for connection of control wiring.

B. (23 09 33.13.B.) Safeties:

1. Compressor over-temperature, over-current. High internal pressure differential.
2. Low pressure switch.
 - a. Low pressure switch shall use different color wire than the high pressure switch. The purpose is to assist the installer and service technician to correctly wire and or troubleshoot the rooftop unit.
3. High pressure switch.
 - a. High pressure switch shall use different color wire than the low pressure switch. The purpose is to assist the installer and service technician to correctly wire and or troubleshoot the rooftop unit.
4. Automatic reset, motor thermal overload protector.

Part 6 — (23 09 93) Sequence of Operations for HVAC Controls

6.01 (23 09 93.13) Decentralized, Rooftop Units:

A. (23 09 93.13.A.) INSERT SEQUENCE OF OPERATION

Part 7 — (23 40 13) Panel Air Filters

7.01 (23 40 13.13) Decentralized, Rooftop Units:

A. (23 40 13.13.A.) Standard filter section:

1. Shall consist of factory installed, low velocity, disposable 2-in. thick fiberglass filters of commercially available sizes.
2. Unit shall use only one filter size. Multiple sizes are not acceptable.
3. Filters shall be accessible through an access panel with “no-tool” removal as described in

the unit cabinet section of this specification (23 81 19.13.G).

Part 8 — (23 81 19) Self-Contained Air Conditioners

8.01 (23 81 19.13) Small-Capacity Self-Contained Air Conditioners:

A. (23 81 19.13.A.) General:

1. Outdoor, rooftop mounted, electrically controlled, heating and cooling unit utilizing a fully hermetic scroll compressor(s) for cooling duty and optional electric heat for heating duty.
2. Factory assembled, single-piece heating and cooling rooftop unit. Contained within the unit enclosure shall be all factory wiring, piping, controls, and special features required prior to field start-up.
3. Unit shall use Puron® (R-410A) refrigerant.
4. Unit shall be installed in accordance with the manufacturer's instructions.
5. Unit must be selected and installed in compliance with local, state, and federal codes.

B. (23 81 19.13.B.) Quality Assurance:

1. Unit meets and exceeds ASHRAE 90.1 minimum efficiency requirements.
2. Unit shall be rated in accordance with AHRI Standards 210/240.
3. Unit shall be designed to conform to ASHRAE 15.
4. Unit shall be UL-tested and certified in accordance with ANSI Z21.47 Standards and UL-listed and certified under Canadian standards as a total package for safety requirements.
5. Insulation and adhesive shall meet NFPA 90A requirements for flame spread and smoke generation.
6. Unit casing shall be capable of withstanding 500 hour salt spray exposure per ASTM B117 (scribed specimen).
7. Unit shall be designed in accordance with ISO 9001, and shall be manufactured in a facility registered by ISO 9001:2015.
8. Roof curb shall be designed to conform to NRCA Standards.
9. Unit shall be subjected to a completely automated run test on the assembly line. The data for each unit will be stored at the factory, and must be available upon request.
10. Unit shall be designed in accordance with UL Standard 1995, including tested to withstand rain.
11. Unit shall be constructed to prevent intrusion of snow and tested to prevent snow intrusion into the control box up to 40 mph.
12. Unit shake tested to assurance level 1, ASTM D4169 to ensure shipping reliability.

- C. (23 81 19.13.C.) Delivery, Storage, and Handling:
 - 1. Unit shall be stored and handled per manufacturer's recommendations.
 - 2. Lifted by crane requires either shipping top panel or spreader bars.
 - 3. Unit shall only be stored or positioned in the upright position.
- D. (23 81 19.13.D.) Project Conditions:
 - 1. As specified in the contract.
- E. (23 81 19.13.E.) Operating Characteristics:
 - 1. Unit shall be capable of starting and running at 125°F (52°C) ambient outdoor temperature, meeting maximum load criteria of AHRI Standard 210/240 at ±10% voltage.
 - 2. Compressor with standard controls shall be capable of operation down to 35°F (2°C), ambient outdoor temperatures. Accessory winter start kit is necessary if mechanically cooling at ambient temperatures down to 25°F (-4°C).
 - 3. Unit shall discharge supply air vertically or horizontally as shown on contract drawings.
 - 4. Unit shall be factory configured for vertical supply and return configurations.
 - 5. Unit shall be field convertible from vertical to horizontal airflow on all models. No special kit required.
 - 6. Unit shall be capable of mixed operation: vertical supply with horizontal return or horizontal supply with vertical return.
- F. (23 81 19.13.F.) Electrical Requirements:
 - 1. Main power supply voltage, phase, and frequency must match those required by the manufacturer.
- G. (23 81 19.13.G.) Unit Cabinet:
 - 1. Unit cabinet shall be constructed of galvanized steel, and shall be bonderized and coated with a pre-painted baked enamel finish on all externally exposed surfaces.
 - 2. Unit cabinet exterior paint shall be: film thickness, (dry) 0.003-in. minimum, gloss (per ASTM D523, 60°F/16°C): 60, Hardness: H-2H Pencil hardness.
 - 3. Evaporator fan compartment interior cabinet insulation shall conform to AHRI Standards 210/240 minimum exterior sweat criteria. Interior surfaces shall be insulated with a minimum 1/2-in. thick, 1 lb density, flexible fiberglass insulation, neoprene coated on the air side. Aluminum foil-faced fiberglass insulation shall be used in the heat compartment.
 - 4. Base of unit shall have a minimum of four locations for thru-the-base gas and electrical connections (factory-installed or field-installed), standard.
- 5. Base Rail:
 - a. Unit shall have base rails on a minimum of 2 sides.
 - b. Holes shall be provided in the base rails for rigging shackles to facilitate maneuvering and overhead rigging.
 - c. Holes shall be provided in the base rail for moving the rooftop by fork truck.
 - d. Base rail shall be a minimum of 16 gage thickness.
- 6. Condensate pan and connections:
 - a. Shall be a sloped condensate drain pan made of a corrosion resistant material.
 - b. Shall comply with ASHRAE Standard 62.
 - c. Shall use a 3/4-in. 14 NPT drain connection, possible either through the bottom or side of the drain pan. Connection shall be made per manufacturer's recommendations.
- 7. Top panel:
 - a. Shall be a single piece top panel on all sizes.
- 8. Electrical Connections:
 - a. All unit power wiring shall enter unit cabinet at a single, factory prepared, knockout location.
 - b. Thru-the-base capability.
 - 1) Standard unit shall have a thru-the-base electrical location(s) using a raised, embossed portion of the unit basepan.
 - 2) Optional, factory approved, water-tight connection method must be used for thru-the-base electrical connections.
 - 3) No basepan penetration, other than those authorized by the manufacturer, is permitted.
- 9. Component access panels (standard):
 - a. Cabinet panels shall be easily removable for servicing.
 - b. Unit shall have one factory installed, tool-less, removable, filter access panel.
 - c. Panels covering control box, indoor fan, indoor fan motor, gas components (where applicable), and compressors shall have molded composite handles.
 - d. Handles shall be UV modified, composite. They shall be permanently attached, and recessed into the panel.
 - e. Screws on the vertical portion of all removable access panel shall engage into heat resistant, molded composite collars.
 - f. Collars shall be removable and easily replaceable using manufacturer recommended parts.

H. (23 81 19.13.H.) Coils:

1. Standard Aluminum Fin-Copper Tube Coils:
 - a. Standard evaporator and condenser coils shall have aluminum lanced plate fins mechanically bonded to seamless internally grooved copper tubes with all joints brazed.
 - b. Evaporator coils shall be leak tested to 150 psig, pressure tested to 450 psig, and qualified to UL 1995 burst test at 1775 psig.
 - c. Condenser coils shall be leak tested to 150 psig, pressure tested to 650 psig, and qualified to UL 1995 burst test at 1980 psig.
2. Optional Pre-coated aluminum-fin condenser coils (3 Phase Models Only):
 - a. Shall have a durable epoxy-phenolic coating to provide protection in mildly corrosive coastal environments.
 - b. Coating shall be applied to the aluminum fin stock prior to the fin stamping process to create an inert barrier between the aluminum fin and copper tube.
 - c. Epoxy-phenolic barrier shall minimize galvanic action between dissimilar metals.
 - d. Corrosion durability of fin stock shall be confirmed through testing to be no less than 1000 hours salt spray per ASTM B117-90.
 - e. Corrosion durability of fin stock shall be confirmed through testing to have no visible corrosion after 48 hour immersion in a room temperature solution of 5% salt, 1% acetic acid.
 - f. Fin stock coating shall pass 2000 hours of the following: one week exposure in the prohesion chamber followed by one week of accelerated ultraviolet light testing. Prohesion chamber: the solution shall contain 3.5% sodium chloride and 0.35% ammonium sulfate. The exposure cycle is one hour of salt fog application at ambient followed by one hour drying at 95°F (35°C).
3. Optional Copper-fin evaporator and condenser coils (3 Phase Models Only):
 - a. Shall be constructed of copper fins mechanically bonded to copper tubes and copper tube sheets.
 - b. Galvanized steel tube sheets shall not be acceptable.
 - c. A polymer strip shall prevent coil assembly from contacting the sheet metal coil pan to minimize potential for galvanic corrosion between coil and pan.
4. Optional E-coated aluminum-fin evaporator and condenser coils (3 Phase Models Only):
 - a. Shall have a flexible epoxy polymer coating uniformly applied to all coil surface areas without material bridging between fins.

- b. Coating process shall ensure complete coil encapsulation of tubes, fins and headers.
- c. Color shall be high gloss black with gloss per ASTM D523-89.
- d. Uniform dry film thickness from 0.8 to 1.2 mil on all surface areas including fin edges.
- e. Superior hardness characteristics of 2H per ASTM D3363-92A and cross-hatch adhesion of 4B-5B per ASTM D3359-93.
- f. Impact resistance shall be up to 160 in. lb (ASTM D2794-93).
- g. Humidity and water immersion resistance shall be up to minimum 1000 and 250 hours respectively (ASTM D2247-92 and ASTM D870-92).
- h. Corrosion durability shall be confirmed through testing to be no less than 1000 hours salt spray per ASTM B117-90.

I. (23 81 19.13.I.) Refrigerant Components:

1. Refrigerant circuit shall include the following control, safety, and maintenance features:
 - a. TXV metering system on all models shall include a multiple feed distribution system.
 - b. Refrigerant filter drier - Solid core design.
 - c. Service gage connections on suction and discharge lines.
 - d. Pressure gage access through a specially designed access port in the top panel of the unit.
2. There shall be gage line access port in the skin of the rooftop, covered by a black, removable plug.
 - a. The plug shall be easy to remove and replace.
 - b. When the plug is removed, the gage access port shall enable maintenance personnel to route their pressure gage lines.
 - c. This gage access port shall facilitate correct and accurate condenser pressure readings by enabling the reading with the compressor access panel on.
 - d. The plug shall be made of a leak proof, UV-resistant, composite material.
3. Compressors:
 - a. Unit shall use fully hermetic, two stage scroll compressor on a single refrigeration circuit.
 - b. Compressor motors shall be cooled by refrigerant gas passing through motor windings.
 - c. Compressors shall be internally protected from high discharge temperature conditions.
 - d. Compressors shall be protected from an over-temperature and over-ampereage conditions by an internal, motor overload device.

- e. Compressor shall be factory mounted on rubber grommets.
 - f. Compressor motors shall have internal line break thermal, current overload and high pressure differential protection.
 - g. Crankcase heaters shall not be required for normal operating range, unless required by compressor manufacturer due to refrigerant charge limits.
- J. (23 81 19.13.J.) Filter Section:
- 1. Filters access is specified in the unit cabinet section of this specification.
 - 2. Filters shall be held in place by a pivoting filter tray, facilitating easy removal and installation.
 - 3. Shall consist of factory installed, low velocity, throw-away 2-in. thick fiberglass filters.
 - 4. Filters shall be standard, commercially available sizes.
 - 5. Only one size filter per unit is allowed.
- K. (23 81 19.13.K.) Evaporator Fan and Motor with EcoBlue™ Technology:
- 1. Direct Drive Evaporator fan motor:
 - a. Shall be a ECM motor design.
 - b. Shall have permanently lubricated bearings.
 - c. Shall have inherent automatic-reset thermal overload protection.
 - d. Shall have slow ramp up to speed capabilities.
 - e. Shall require no fan/motor belts for operation, adjustments and or initial fan speed set up.
 - f. Fan DC voltage set up on Unit Control Board can eliminate the need of removal of blower access door, required on conventional belt drive systems.
 - g. Shall be internally protected from electrical phase reversal and loss.
 - 2. Evaporator Fan:
 - a. Shall be easily set with selection switch and adjustment pot on unit control board or through SystemVu™ controller.
 - b. On all sizes 04-06 which have two stage cooling capacity control, the indoor fan speed is automatically controlled to meet the AHRI performance requirement with 75% low fan speed and 100% at full fan speed operation
 - c. Blower fan shall be a Vane Axial fan design with 75% less moving parts than a conventional belt drive system.
 - d. Shall be constructed of a cast aluminum stator and high impact composite material on rotor and air inlet casing.
- e. Shall be a patented / pending design with a corrosion resistant material and dynamically balanced.
 - f. Shall have slow ramp up to speed capabilities to help reduce sound and comfort issues typically associated with single speed belt drive systems.
 - g. Shall be a slide out design with two screw removal.
3. Shall include an easily accessible unit Control Board to conveniently and safely provide connection points for vital control functions such as: smoke detectors, phase monitor, gas controller, economizer, thermostat, DDC control options, and low and high pressure switches. Controller shall also provide an intuitive means to adjust the indoor fan speed through a simple switch and pot adjustment design.
- L. (23 81 19.13.L.) Condenser Fans and Motors:
- 1. Condenser fan motors:
 - a. Shall be a totally enclosed motor.
 - b. Shall use permanently lubricated bearings.
 - c. Shall have inherent thermal overload protection with an automatic reset feature.
 - d. Shall use a shaft-down design on all sizes.
 - 2. Condenser Fans:
 - a. Shall be a direct-driven propeller type fan constructed of high impact composite material.
 - b. Shall have high impact composite blades completely formed into one piece without blade fasteners or connectors and shall be dynamically balanced.
- M. (23 81 19.13.M.) Special Features Options and Accessories:
- 1. Integrated EconoMi\$er® IV, EconoMi\$er2, and EconoMi\$er X low leak rate models. (EconoMi\$er2, and EconoMi\$er X are factory-installed on 3 phase models only. All are field-installed on all 3 and 1 phase models.)
 - a. Integrated, gear driven opposing modulating blade design type capable of simultaneous economizer and compressor operation.
 - b. Independent modules for vertical or horizontal return configuration shall be available. Vertical return modules shall be available as a factory installed option.
 - c. Damper blades shall be galvanized steel with composite gears. Plastic or composite blades on intake or return shall not be acceptable.
 - d. Shall include all hardware and controls to provide free cooling with outdoor air when temperature and/or humidity are below setpoints.

- e. Shall be equipped with gear driven dampers for both the outdoor ventilation air and the return air for positive air stream control.
 - f. Low leak rate shall be equipped with dampers not to exceed 2% leakage at 1 in. wg pressure differential.
 - g. Economizer controller on EconoMi\$er IV (field-installed only) models shall be Honeywell W7212 that provides:
 - 1) Combined minimum and DCV maximum damper position potentiometers with compressor staging relay.
 - 2) Functions with solid-state analog enthalpy or dry bulb changeover control sensing.
 - 3) Contain LED indicates for: when free cooling is available, when module is in DCV mode, when exhaust fan contact is closed.
 - h. Economizer controller on EconoMi\$er X models shall be the Honeywell W7220 that provides:
 - 1) 2-line LCD interface screen for setup, configuration and troubleshooting.
 - 2) On-board Fault Detection and Diagnostics (FDD) that senses and alerts when the economizer is not operating properly, per California Title 24, ASHRAE 90.1 and IECC.
 - 3) Sensor failure loss of communication identification.
 - 4) Automatic sensor detection.
 - 5) Capabilities for use with multiple-speed or single speed indoor fan systems.
 - 6) Utilize digital sensors: Dry bulb and Enthalpy.
 - i. Economizer controller on EconoMi\$er® 2 models with RTU Open or SystemVu controllers shall be a 4-20mA design controlled directly by the controller. RTU Open and SystemVu meet California Title 24, ASHRAE 90.1 and IECC¹ Fault Detection and Diagnostic (FDD) requirements.
 - j. Shall be capable of introducing up to 100% outdoor air.
 - k. Shall be equipped with a barometric relief damper capable of relieving up to 100% return air and contain seals that meet ASHRAE 90.1 requirements.
 - l. Shall be designed to close damper(s) during loss-of-power situations with spring return built into motor.
 - m. Dry bulb outdoor air temperature sensor shall be provided as standard. Enthalpy sensor is also available on factory installed only. Outdoor air sensor setpoint shall be adjustable and shall range from 40°F to 100°F (4°C to 38°C). Additional sensor options shall be available as accessories.
 - n. The economizer controller shall also provide control of an accessory power exhaust unit function. Factory set at 100%, with a range of 0% to 100%.
 - o. The economizer shall maintain minimum airflow into the building during occupied period and provide design ventilation rate for full occupancy.
 - p. Dampers shall be completely closed when the unit is in the unoccupied mode.
 - q. Economizer controller shall accept a 2 to 10 vdc CO₂ sensor input for IAQ/DCV control. In this mode, dampers shall modulate the outdoor air damper to provide ventilation based on the sensor input.
 - r. Compressor lockout temperature on W7220 control is adjustable from -45°F to 80°F, set at a factory default of 32°F. W7212 control opens at 35°F (2°C) and closes at 50°F (10°C).
 - s. Actuator shall be direct coupled to economizer gear. No linkage arms or control rods shall be acceptable.
 - t. Economizer controller shall provide indications when in free cooling mode, in the DCV mode, or the exhaust fan contact is closed.
2. Integrated EconoMi\$er®2, and EconoMi\$er X Ultra Low Leak rate models. (Factory installed on 3 phase models only. Field installed on all 3 and 1 phase models.)
- a. Integrated, gear driven opposing modulating blade design type capable of simultaneous economizer and compressor operation.
 - b. Independent modules for vertical or horizontal return configuration shall be available. Vertical return modules shall be available as a factory-installed option.
 - c. Damper blades shall be galvanized steel with composite gears. Plastic or composite blades on intake or return shall not be acceptable.
 - d. Shall include all hardware and controls to provide free cooling with outdoor air when temperature and/or humidity are below setpoints.
 - e. Shall be equipped with gear driven dampers for both the outdoor ventilation air and the return air for positive air stream control.
 - f. Ultra Low Leak design meets California Title 24 section 140.4 and ASHRAE 90.1 requirements for 4 cfm per sq. ft on the outside air dampers and 10 cfm per sq. ft on the return dampers.

1. IECC is a registered trademark of the International Code Council, Inc.

- g. Economizer controller on EconoMi\$er X models shall be the Honeywell W7220 that provides:
 - 1) 2-line LCD interface screen for setup, configuration and troubleshooting.
 - 2) On-board Fault Detection and Diagnostics (FDD) that senses and alerts when the economizer is not operating properly, per California Title 24, ASHRAE 90.1 and IECC.
 - 3) Sensor failure loss of communication identification.
 - 4) Automatic sensor detection.
 - 5) Capabilities for use with multiple-speed indoor fan systems.
 - 6) Utilize digital sensors: Dry bulb and Enthalpy.
 - h. Economizer controller on EconoMi\$er 2 models with RTU Open or SystemVu controls shall be a 4 to 20mA design controlled directly by the controller. RTU Open and SystemVu meet California Title 24, ASHRAE 90.1 and IECC Fault Detection and Diagnostic (FDD) requirements.
 - i. Shall be capable of introducing up to 100% outdoor air.
 - j. Shall be equipped with a barometric relief damper capable of relieving up to 100% return air and contain seals that meet ASHRAE 90.1 requirements.
 - k. Shall be designed to close damper(s) during loss-of-power situations with spring return built into motor.
 - l. Dry bulb outdoor air temperature sensor shall be provided as standard. Enthalpy sensor is also available on factory installed only. Outdoor air sensor setpoint shall be adjustable and shall range from 40°F to 100°F (4°C to 38°C). Additional sensor options shall be available as accessories.
 - m. The economizer controller shall also provide control of an accessory power exhaust unit function. Factory set at 100%, with a range of 0% to 100%.
 - n. The economizer shall maintain minimum airflow into the building during occupied period and provide design ventilation rate for full occupancy.
 - o. Dampers shall be completely closed when the unit is in the unoccupied mode.
 - p. Economizer controller shall accept a 2 to 10 vdc CO₂ sensor input for IAQ/DCV control. In this mode, dampers shall modulate the outdoor air damper to provide ventilation based on the sensor input.
 - q. Compressor lockout temperature on W7220 control is adjustable from -45°F to 80°F, set at a factory default of 32°F. W7212 control opens at 35°F (2°C) and closes at 50°F (10°C).
 - r. Actuator shall be direct coupled to economizer gear. No linkage arms or control rods shall be acceptable.
 - s. Economizer controller shall provide indications when in free cooling mode, in the DCV mode, or the exhaust fan contact is closed.
3. Two-Position Damper (field-installed only):
 - a. Damper shall be a Two-Position Damper. Damper travel shall be from the full closed position to the field adjustable %-open setpoint.
 - b. Damper shall include adjustable damper travel from 25% to 100% (full open).
 - c. Damper shall include single or dual blade, gear driven dampers and actuator motor.
 - d. Actuator shall be direct coupled to damper gear. No linkage arms or control rods shall be acceptable.
 - e. Damper will admit up to 100% outdoor air for applicable rooftop units.
 - f. Damper shall close upon indoor (evaporator) fan shutoff and/or loss of power.
 - g. The damper actuator shall plug into the rooftop unit's wiring harness plug. No hard wiring shall be required.
 - h. Outside air hood shall include aluminum water entrainment filter.
 4. Manual damper (field-installed only):
 - a. Manual damper package shall consist of damper, air inlet screen, and rain hood which can be pre-set to admit up to 25% or 50% outdoor air for year round ventilation.
 5. Humidi-MiZer® Adaptive Dehumidification System (3 Phase Models Only):
 - a. The Humidi-MiZer Adaptive Dehumidification System shall be factory installed and shall provide greater dehumidification of the occupied space by two modes of dehumidification operations in addition to its normal design cooling mode:
 - 1) Subcooling mode further sub cools the hot liquid refrigerant leaving the condenser coil when both temperature and humidity in the space are not satisfied.
 - 2) Hot gas reheat mode shall mix a portion of the hot gas from the discharge of the compressor with the hot liquid refrigerant leaving the condenser coil to create a two-phase heat transfer in the system, resulting in a neutral leaving air temperature when only humidity in the space is not satisfied.
 - 3) Includes low ambient controller.

6. Low Ambient Control Package:
 - a. Controller shall control coil head pressure by condenser fan speed modulation or condenser fan cycling and wind baffles.
 - b. Shall consist of solid-state control and condenser coil temperature sensor to maintain condensing temperature between 90°F (32°C) and 110°F (43°C) at outdoor ambient temperatures down to -20°F (-29°C).
7. Condenser Coil Hail Guard Assembly (Factory-installed on 3 Phase Models Only. Field-installed on all 3 and 1 Phase Models.)
 - a. Shall protect against damage from hail.
 - b. Shall be either hood style or louvered.
8. Unit-Mounted, Non-Fused Disconnect Switch (Available on units with MOCs of 80 amps or less):
 - a. Switch shall be factory installed, internally mounted.
 - b. National Electric Code (NEC) and UL approved non-fused switch shall provide unit power shutoff.
 - c. Shall be accessible from outside the unit.
 - d. Shall provide local shutdown and lockout capability.
 - e. Sized only for the unit as ordered from the factory. Does not accommodate field-installed devices.
9. HACR Breaker:
 - a. These manual reset devices provide overload and short circuit protection for the unit. Factory wired and mounted with the units, with access cover to help provide environmental protection. On 575V applications, HACR breaker can only be used with WYE power distribution systems. Use on Delta power distribution systems is prohibited.
 - b. Sized only for the unit as ordered from the factory. Does not accommodate field-installed devices.
10. Convenience Outlet:
 - a. Powered convenience outlet. (3 Phase Models Only)
 - 1) Outlet shall be powered from main line power to the rooftop unit.
 - 2) Outlet shall be powered from line side or load side of disconnect by installing contractor, as required by code. If outlet is powered from load side of disconnect, unit electrical ratings shall be UL certified and rated for additional outlet amperage.
 - 3) Outlet shall be factory-installed and internally mounted with easily accessible 115-v female receptacle.
 - 4) Outlet shall include 15 amp GFI receptacles with independent fuse protection.
 - b. Factory-Installed Non-Powered convenience outlet.
 - 1) Outlet shall be powered from a separate 115/120v power source.
 - 2) A transformer shall not be included.
 - 3) Outlet shall be factory-installed and internally mounted with easily accessible 115-v female receptacle.
 - 4) Outlet shall include 15 amp GFI receptacles with independent fuse protection.
 - 5) Outlet shall be accessible from outside the unit.
 - 6) Outlet shall include a field installed “Wet in Use” cover.
 - c. Field-Installed non-powered convenience outlet.
 - 1) Outlet shall be powered from a separate 115/120v power source.
 - 2) A transformer shall not be included.
 - 3) Outlet shall be field-installed and internally mounted with easily accessible 115-v female receptacle.
 - 4) Outlet shall include 20 amp GFI receptacles. This kit provides a flexible installation method which allows code compliance for height requirements of the GFCI outlet from the finished roof surface as well as the capability to relocate the outlet to a more convenient location.
 - 5) Outlet shall be accessible from outside the unit.
 - 6) Outlet shall include a field installed “Wet in Use” cover.
11. Thru-the-Base Connectors:
 - a. Kits shall provide connectors to permit gas and electrical connections to be brought to the unit through the unit basepan.
 - b. Minimum of four connection locations per unit.
12. Propeller Power Exhaust:
 - a. Power exhaust shall be used in conjunction with an integrated economizer.
 - b. Independent modules for vertical or horizontal return configurations shall be available.
 - c. Horizontal power exhaust is shall be mounted in return ductwork.
 - d. Power exhaust shall be controlled by economizer controller operation. Exhaust fans shall be energized when dampers open past the 0 to 100% adjustable setpoint on the economizer control.
- 5) Voltage required to operate convenience outlet shall be provided by a factory installed step-down transformer.
- 6) Outlet shall be accessible from outside the unit.
- 7) Outlet shall include a field installed “Wet in Use” cover.

13. Roof Curbs (Vertical):
 - a. Full perimeter roof curb with exhaust capability providing separate air streams for energy recovery from the exhaust air without supply air contamination.
 - b. Formed galvanized steel with wood nailer strip and shall be capable of supporting entire unit weight.
 - c. Permits installation and securing of ductwork to curb prior to mounting unit on the curb.
14. Outdoor Air Enthalpy Sensor:
 - a. The outdoor air enthalpy sensor shall be used to provide single enthalpy control. When used in conjunction with a return air enthalpy sensor, the unit will provide differential enthalpy control. The sensor allows the unit to determine if outside air is suitable for free cooling.
15. Return Air Enthalpy Sensor:
 - a. The return air enthalpy sensor shall be used in conjunction with an outdoor air enthalpy sensor to provide differential enthalpy control.
16. Indoor Air Quality (CO₂) Sensor:
 - a. Shall be able to provide demand ventilation indoor air quality (IAQ) control.
 - b. The IAQ sensor shall be available in duct mount, wall mount, or wall mount with LED display. The setpoint shall have adjustment capability.
17. Smoke detectors (factory-installed only):
 - a. Shall be a four-wire controller and detector.
 - b. Shall be environmental compensated with differential sensing for reliable, stable, and drift-free sensitivity.
 - c. Shall use magnet-activated test/reset sensor switches.
 - d. Shall have tool-less connection terminal access.
 - e. Shall have a recessed momentary switch for testing and resetting the detector.
 - f. Controller shall include:
 - 1) One set of normally open alarm initiation contacts for connection to an initiating device circuit on a fire alarm control panel.
 - 2) Two Form-C auxiliary alarm relays for interface with rooftop unit or other equipment.
 - 3) One Form-C supervision (trouble) relay to control the operation of the Trouble LED on a remote test/reset station.
 - 4) Capable of direct connection to two individual detector modules.
- 5) Can be wired to up to 14 other duct smoke detectors for multiple fan shut-down applications.
18. Winter Start Kit:
 - a. Shall contain a bypass device around the low pressure switch.
 - b. Shall be required when mechanical cooling is required down to 25°F (-4°C).
 - c. Shall not be required to operate on an economizer when below an outdoor ambient of 35°F (2°C).
19. Time Guard:
 - a. Shall prevent compressor short-cycling by providing a 5 minute delay (±2 minutes) before restarting a compressor after shut-down for any reason.
 - b. One device shall be required per compressor.
20. Hinged Access Panels:
 - a. Shall provide easy access through integrated quarter turn latches.
 - b. Shall be on major panels of: filter, control box, fan motor, and compressor.
21. Condensate overflow switch:
 - a. This sensor and related controller monitors the condensate level in the drain pan and shuts down compression operation when overflow conditions occur. It includes:
 - 1) Indicator light — solid red (more than 10 seconds on water contact – compressors disabled), blinking red (sensor disconnected).
 - 2) 10 second delay to break — eliminates nuisance trips from splashing or waves in pan (sensor needs 10 seconds of constant water contact before tripping).
 - 3) Disables the compressor(s) operation when condensate plug is detected, but still allows fans to run for economizer.
22. Foil Faced Insulation:
 - a. Throughout unit cabinet air stream, non-fibrous and cleanable foil faced insulation is used.
23. MERV-8 Return Air filters:
 - a. Factory option to upgrade standard unit filters to MERV-8 filters.
24. Phase Monitor Control:
 - a. Shall monitor the sequence of three phase electrical system to provide a phase reversal protection
 - b. Shall monitor the three phase voltage inputs to provide a phase loss protection for the three phase device.
 - c. Will work on either a Delta or Wye power connection.

Guide specifications – 50GC (cont)

25. Horn/Strobe Annunciator:

- a. Provides an audible/visual signaling device for use with factory-installed option or field installed accessory smoke detectors.
 - 1) Requires installation of a field-supplied 24-v transformer suitable for 4.2 VA (AC) or 3.0 VA (DC) per horn/strobe accessory.
 - 2) Requires field-supplied electrical box, North American 1-gang box, 2-in. (51 mm) x 4-in. (102 mm).
 - 3) Shall have a clear colored lens.

26. Electric Heat:

- a. Heating Section:
 - 1) Heater element open coil resistance wire, nickel-chrome alloy, 0.29-in. inside diameter, strung through ceramic insulators mounted on metal frame. Coil ends are staked and welded to terminal screw slots.
 - 2) Heater assemblies are provided with integral fusing for protection of internal heater circuits not exceeding 48 amps each. Auto reset thermo limit controls, magnetic heater contactors (24-v coil) and terminal block all mounted in electric heater control box (minimum 18 ga galvanized steel) attached to end of heater assembly.

