



Turn to the experts

## Product Data

### AquaSnap®

### Air-Cooled Chillers

60 to 300 Nominal Tons

greenspeed  
**AQUASNAP**



30RB060-300 Air-Cooled Chillers and  
30RB080-300 Air-Cooled Chillers with  
Greenspeed® Intelligence

**The AquaSnap® chiller is an effective all-in-one package that is easy to install and easy to own. AquaSnap chillers cost less to purchase and install, and then operate quietly and efficiently. Value-added features include:**

- Rotary scroll compression
- Puron® HFC refrigerant (R-410A)
- Quiet AeroAcoustic™ fan system
- Easy to use *ComfortLink* controls
- Optional integrated hydronic pump package, available with variable frequency drive (VFD)
- Novation® heat exchanger technology with microchannel coil
- High-efficiency, variable-speed condenser fans (30RB080-300 with Greenspeed intelligence)

Carrier's superior chiller design provides savings at initial purchase, at installation, and for years afterward.

### **Cost savings right from the start**

Carrier's AquaSnap chillers feature a compact, all-in-one package design that installs quickly and easily on the ground or the rooftop. The optional pump and hydronic components are already built in; this costs less than buying and installing the components individually. The chiller's fully integrated and pre-assembled hydronic system installs in minutes.

No other chiller in this class installs so easily and inexpensively. The preassembled and integrated hydronic module uses reliable top-quality components and pumps. The AquaSnap unit's high efficiency keeps operating costs down.

### **AquaSnap chillers make noise in the marketplace, not the workplace**

The AquaSnap chiller's AeroAcoustic™ fan system is extremely quiet. Much of the noise reduction is in frequencies where noise is most annoying, which makes AquaSnap chillers ideal for sound-sensitive environments. When lower ambient temperatures allow part load operation or during scheduled nighttime operation, the units operate with fewer fans and become even quieter. AquaSnap chillers are quiet during the day and even quieter at night.

### **The savings will continue to mount**

Besides being affordable to buy and install, AquaSnap chillers are also affordable to operate. Carrier's Aqua Series chillers are our most efficient air-cooled models. The 30RB chillers provide full-load EER (Energy Efficiency Ratio) up to 10.3<sup>1</sup>. The 30RB chiller provides an IPLV (integrated part load value) up to 14.3, while the 30RB chiller with Greenspeed® intelligence provides an IPLV up to 17.1.

Aqua-Snap chillers use ultra-quiet, high-efficiency rotary scroll compressors, operated in tandem, trios or quads per independent circuit for greater efficiency at partial loads.

30RB chillers with Greenspeed intelligence feature a high-efficiency, variable-speed condenser fan option along with fine-tuned *ComfortLink* controls, which together provide premium part load efficiency to facilitate reduced utility costs over the lifespan of the chiller. Additionally, the lower sound levels achieved at part load conditions can be very beneficial for sensitive acoustic applications.

Standard DC link reactor for 30RB units with Greenspeed intelligence is included in all drives for the fans. The use of this component mitigates customer concern over electrical system harmonics, and therefore AC line reactors should not be required for applications employing 30RB chillers with Greenspeed intelligence.

Electronic expansion valve allows for precise control through all operating ranges, resulting in higher efficiencies.

### **Proven reliability is built in**

Thousands of AquaSnap chillers are already in service around the world. This field-proven design is backed by a 12-month warranty that includes the optional hydronic system (U.S.A. and Canada only). The compressors are maintenance-free and protected by an auto-adaptive control that minimizes compressor wear. Year-round operation is standard, from -20°F (-29°C) (with optional cooler heater, low ambient control, and wind baffles) to 125°F (52°C).

Rotary scroll compressors provide smooth, quiet and reliable operation.

**Multiple independent circuits** are standard on all AquaSnap chillers for redundancy and greater reliability.

### **All-in-one package**

AquaSnap chillers provide the most comprehensive chilled water circuit available for any air-cooled chiller. Included is a shell-in-tube direct expansion cooler that may be remote-mounted. The cooler is also completely drainable with factory-installed vents and drains.

**Electronic thermal-dispersion flow switch** is included with the cooler. The switch is factory installed and tested and contains no moving parts for high reliability.

## Table of contents

Features/Benefits . . . . .	2
Model Number Nomenclature . . . . .	5
Physical Data . . . . .	6
Options and Accessories . . . . .	14
Dimensions . . . . .	17
Selection Procedure . . . . .	29
Typical Piping and Wiring . . . . .	43
Electrical Data . . . . .	46
Controls . . . . .	55
Typical Control Wiring Schematic . . . . .	58
Application Data . . . . .	59
Guide Specifications . . . . .	66

1. Model numbers that reach an EER of up to 10.3 include 090, 120, 160, and 315.

**Optional integrated hydronics package** is more than just a pump, it is an entire chilled water system, including:

- Single/dual pumps up to 15 hp and 140 ft (42.7 m) head
- Availability at constant speed or VFD configuration
- Strainer
- Start-up strainer (to be removed within 24 hours after chiller start-up)
- Flow regulator
- Freeze protection to  $-20^{\circ}\text{F}$  ( $-29^{\circ}\text{C}$ ) (with freeze protection option)
- Heaters
- Required piping
- Pressure/temperature taps
- Isolation check valves for dual pump systems

The factory-installed and tested hydronics package provides faster, simpler and less expensive installation.

### **Environmentally balanced**

Carrier's Puron<sup>®</sup> refrigerant (R-410A) enables one to make a responsible decision in the protection of the earth's ozone layer. Puron refrigerant is an HFC refrigerant that does not contain chlorine that is damaging to the ozone layer. This refrigerant is a safe, efficient, and environmentally balanced refrigerant.

### **Structurally sound**

The base rail is industrial-quality 7 ga for maximum structural integrity. The zinc-dipped galvanized frame (with Magni-coated screws) provides the best protection on the market for corrosion resistance. With such a structurally sound base, no perimeter base rail is needed.

### **ComfortLink controls speak your language**

The *ComfortLink* controls communicate in plain English, making it as easy

as possible to monitor and control each AquaSnap chiller while accurately maintaining fluid temperatures. The large scrolling marquee display acts as a window into the unit's operation, providing easy-to-read information about chiller performance and over 15 diagnostic functions. Carrier's 30 Series chillers' *ComfortLink* controls provide features such as chilled water temperature reset, demand limiting, compressor wear minimization and protection, temperature and pressure displays and diagnostic functions. These controls result in higher chiller reliability, simplified training and more productive service calls with correspondingly lower operational and maintenance costs.

Carrier's exclusive handheld Navigator<sup>™</sup> display provides convenience and powerful information in the palm of your hand. The Navigator display helps technicians to quickly diagnose problems and even prevent them from occurring.

All AquaSnap units are ready to be used with the Carrier Comfort Network<sup>®</sup> (CCN) system.

A BACnet<sup>1</sup> communication option is also available for the i-Vu<sup>®</sup> Open control system or a third-party BACnet building automation system.

### **Seismic certification**

A seismic unit modification is available which will result in a unit SDS (seismic design acceleration parameter) level of 2.0.

### **Novation<sup>®</sup> heat exchanger technology**

The Novation heat exchanger design with microchannel (MCHX) condenser

coil is a robust, cost effective alternative to traditional coil design. These coils are offered coated or uncoated to match coil protection to site conditions. The e-coated version of this coil can withstand an 8000-hour salt spray test in accordance with ASTM B-117 Standard. The Carrier Electronic Catalog (E-Cat) can be used to determine whether or not corrosion protection is recommended for particular applications in coastal/marine environments. Following the input of the requested data, the E-Cat program output will advise the appropriate coil to be used.

Other factors described in "Selection Guide: Environmental Corrosion Protection," catalog number 04-581061-01, must also be considered to determine if corrosion protection is required.

Microchannel coils are sturdier than other coil types; thus, easier to clean without causing damage to the coil.

Due to the compact all-aluminum design, microchannel coils will reduce overall unit operating weight by 6 to 7%. The streamlined MCHX coil design reduces refrigerant charge by up to 30%.

The coil is designed with rubber isolation around the powder painted coil frame to eliminate galvanic couples, which can cause corrosion due to dissimilar metals.

### **Optional desuperheater**

For applications with a simultaneous requirement for chilled water and tempered hot water, the use of a desuperheater is an ideal solution. The production of useful hot water in conjunction with useful chilled water can lead to greatly improved COP (coefficient of performance).

1. BACnet is a registered trademark of ASHRAE (American Society of Heating, Refrigerating, and Air-Conditioning Engineers).





**NAVIGATOR™ DISPLAY**

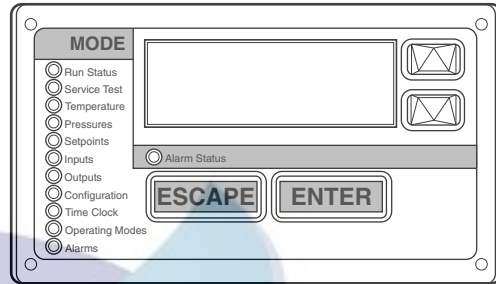

**SCROLLING MARQUEE DISPLAY**

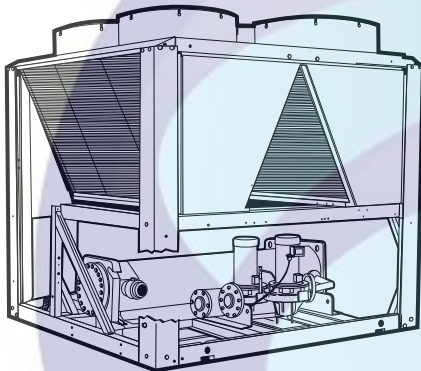

**OPTIONAL HYDRONIC PACKAGE**

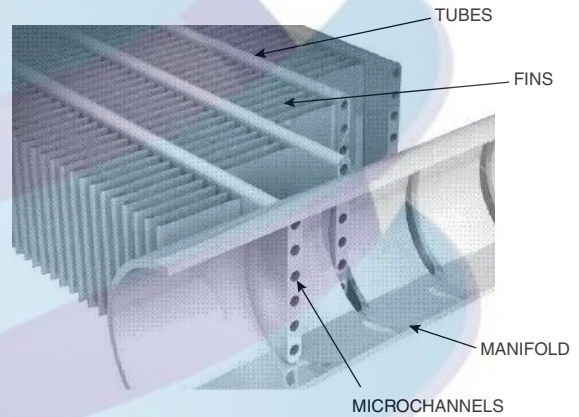

**NOVATION® HEAT EXCHANGER TECHNOLOGY WITH MICROCHANNEL CONDENSER COILS**

# IEECSA

## AIRE ACONDICIONADO

# Model number nomenclature



30RB F 190 6 4 - L - - - L

30RB – Air-Cooled AquaSnap® Chiller

## Design Series

### Nominal Sizes

060	110	170	275
070	120	190	300
080	130	210	
090	150	225	
100	160	250	

### Voltage

- 1 – 575-3-60
- 2 – 380-3-60
- 5 – 208/230-3-60
- 6 – 460-3-60

### Condenser Coil Options

- – Aluminum Fin/Copper Tube
- 0 – Copper Fin/Copper Tube
- 1 – Aluminum Pre-Coat Fin/Copper Tube
- 2 – Aluminum E-Coat Fin/Copper Tube
- 3 – Copper E-Coat Fin/Copper Tube
- 4 – Microchannel (MCHX)
- 5 – E-Coat, Microchannel (MCHX)

### Hydronics Option\*

- – No Pump Installed
- 0 – Single Pump, 3 HP
- 1 – Single Pump, 5 HP
- 2 – Single Pump, 7.5 HP
- 3 – Single Pump, 10 HP
- 4 – Single Pump, 15 HP
- 6 – Dual Pump, 3 HP
- 7 – Dual Pump, 5 HP
- 8 – Dual Pump, 7.5 HP, Low Head
- 9 – Dual Pump, 7.5 HP, High Head
- B – Dual Pump, 10 HP
- C – Dual Pump, 15 HP
- F – Single Pump, 3 HP w/ VFD
- G – Single Pump, 5 HP w/ VFD
- H – Single Pump, 7.5 HP w/ VFD
- J – Single Pump, 10 HP w/ VFD
- K – Single Pump, 15 HP w/ VFD
- M – Dual Pump, 3 HP w/ VFD
- N – Dual Pump, 5 HP w/ VFD
- P – Dual Pump, 7.5 HP, Low Head w/ VFD
- T – Dual Pump, 7.5 HP, High Head w/ VFD
- Q – Dual Pump, 10 HP w/ VFD
- R – Dual Pump, 15 HP w/ VFD
- Z – Special order designation

### Cooler Options

- – Integral Cooler, CRN (Canada)
- 0 – Integral Cooler, Cooler Heater, CRN (Canada)
- 4 – Integral Cooler, Microchannel (MCHX), CRN (Canada)
- 5 – Integral Cooler, Cooler Heater, Microchannel (MCHX), CRN (Canada)
- G – Integral Cooler, no CRN
- H – Integral Cooler, Cooler Heater, no CRN
- K – Integral Cooler, Microchannel (MCHX), no CRN
- L – Integral Cooler, Cooler Heater, Microchannel (MCHX), no CRN

### LEGEND

- CRN — Canadian Registration Number
- ETO — Engineered to Order
- MCHX — Microchannel Condenser Coil
- SCCR — Short Circuit Current Rating
- XL — Cross-the-Line Start

\*Hydronic pumps not available on units 30RB060-190 with high SCCR option.

NOTE: A "Z" in position 11 indicates a special order machine. Digits following do not correspond to tables.

## Quality Assurance

ISO 9001: 2015-certified processes

### Packaging/Security Options

- L – No Packaging
- 0 – Skid
- 1 – Skid, Top Crate, Bag
- 3 – Coil Trim Panels
- 4 – Skid, Coil Trim Panels
- 5 – Skid, Top Crate, Bag, Coil Trim Panels
- 7 – Coil Trim Panels, Upper and Lower Grilles
- 8 – Skid, Coil Trim Panels, Upper and Lower Grilles
- 9 – Skid, Top Crate, Bag, Coil Trim Panels, Upper and Lower Grilles
- C – Trim Panels, Upper and Lower Grilles, Upper Hail Guards
- D – Skid, Trim Panels, Upper and Lower Grilles, Upper Hail Guards
- F – Skid, Top Crate, Bag, Trim Panels, Upper and Lower Grilles, Upper Hail Guards
- H – Skid, Full End Covers
- J – Skid, Top Crate, Bag, Full End Covers
- K – Full End Covers

### Controls/Communication Options

- – None
- 0 – EMM
- 1 – Remote Service Point, GFI-CO
- 2 – EMM, Remote Service Point, GFI-CO
- 3 – BACnet Communication
- 4 – BACnet Communication, EMM
- 5 – BACnet Communication, Remote Service Port, GFI-CO
- 6 – BACnet Communication, EMM, Remote Service Port, GFI-CO
- 7 – BACnet Translator
- 8 – BACnet Translator, EMM
- 9 – BACnet Translator, Remote Service Port, GFI-CO
- B – BACnet Translator, EMM, Remote Service Port, GFI-CO
- H – LON Translator
- J – LON Translator, EMM
- K – LON Translator, Remote Service Port, GFI-CO
- L – LON Translator, EMM, Remote Service Port, GFI-CO

### Electrical/Low Sound/High SCCR Options

- – Single Point Power Connections, XL, Terminal Block
- 3 – Dual Point Power Connections, XL, Terminal Block
- 7 – Single Point Power Connections, XL, Non-Fused Disconnect
- 8 – Single Point Power Connections, XL, Non-Fused Disconnect, High SCCR
- C – Dual Point Power, XL, Non-Fused Disconnect
- D – Dual Point Power, XL, Non-Fused Disconnect, High SCCR
- G – Single Point Power Connections, XL, Terminal Block, Cmpr Blankets
- J – Dual Point Power Connections, XL, Terminal Block, Cmpr Blankets
- L – Single Point Power Connections, XL, Non-Fused Disconnect, Cmpr Blankets
- M – Single Point Power Connections, XL, Non-Fused Disconnect, Cmpr Blankets, High SCCR
- N – Dual Point Power, XL, Non-Fused Disconnect, Cmpr Blankets
- P – Dual Point Power, XL, Non-Fused Disconnect, Cmpr Blankets, High SCCR
- Q – Single Point Power Connections, XL, Terminal Block, Cmpr Blankets, Cmpr Enclosures
- S – Dual Point Power Connections, XL, Terminal Block, Cmpr Blankets, Cmpr Enclosures
- V – Single Point Power Connections, XL, Non-Fused Disconnect, Cmpr Blankets, Cmpr Enclosures
- W – Single Point Power Connections, XL, Non-Fused Disconnect, Cmpr Blankets, Cmpr Enclosures, High SCCR
- X – Dual Power Point, XL, Non-Fused Disconnect, Cmpr Blankets, Cmpr Enclosures
- Y – Dual Power Point, XL, Non-Fused Disconnect, Cmpr Blankets, Cmpr Enclosures, High SCCR

### Refrigeration Circuit Options

- – None
- 0 – Suction Line Insulation
- 1 – Suction Service Valves
- 3 – Suction Line Insulation, Suction Service Valves
- 4 – Suction Line Insulation, Low Ambient Head Pressure Control Operation
- 5 – Suction Service Valves, Low Ambient Head Pressure Control Operation
- 6 – Suction Line Insulation, Suction Service Valves, Head Pressure Control
- 7 – Minimum Load Control
- 8 – Suction Line Insulation, Minimum Load Control
- 9 – Suction Service Valves, Minimum Load Control
- B – Low Ambient Head Pressure Control Operation, Minimum Load Control
- C – Suction Line Insulation, Suction Service Valves, Minimum Load Control
- D – Suction Line Insulation, Head Pressure Control, Minimum Load Control
- F – Suction Service Valves, Head Pressure Control, Minimum Load Control
- G – Suction Line Insulation, Suction Service Valves, Low Ambient Head Pressure Control, Operation, Minimum Load Control Operation
- H – Suction Service Valves, High-Efficiency Variable Condenser Fans
- J – Suction Line Insulation, Suction Service Valve, High-Efficiency Variable Condenser Fans
- K – High-Efficiency Variable Condenser Fans
- L – Suction Line Insulation, High-Efficiency Variable Condenser Fans
- M – Suction Service Valves, High-Efficiency Variable Condenser Fans, Minimum Load Control Operation
- N – Suction Line Insulation, Suction Service Valve, High-Efficiency Variable Condenser Fans, Minimum Load Control Operation
- P – High-Efficiency Variable Condenser Fans, Minimum Load Control Operation
- Q – Suction Line Insulation, High-Efficiency Variable Condenser Fans, Minimum Load Control Operation

## 30RB060-300 — ENGLISH

UNIT 30RB	060	070	080	090	100	110	120	130	150
<b>OPERATING WEIGHT (lb)*</b>									
Al-Cu Condenser Coil	4,111	4,317	4,600	5,932	6,155	6,519	7,690	8,045	9,174
Cu-Cu Condenser Coil	4,593	4,799	5,082	6,656	6,879	7,243	8,534	9,010	10,139
MCHX Condenser Coil	3,783	3,978	4,267	5,449	5,663	6,027	7,119	7,402	8,517
<b>REFRIGERANT TYPE†</b>									
R-410A, EXV Controlled System									
Refrigerant Charge (lb)									
RTPF Coil, Ckt A/Ckt B/Ckt C	89.5/34/— 40/20/—	94/34/— 40/20/—	68.5/68.5/ — 33/33/—	94/76/— 40/40/—	94/96/— 40/42/—	94/106/— 40/53/—	94/133/— 43/57/—	133/106/— 54/43/—	133/133/— 56/62/—
MCHX Coil, Ckt A/Ckt B/Ckt C									
<b>COMPRESSORS</b>									
Scroll, Hermetic									
Quantity	3	3	4	4	4	5	5	6	6
Speed (rpm)	3500								
(Qty) Compressor Model Number Ckt A	(2) SH240	(2) SH295	(2) SH240	(2) SH295	(2) SH295	(2) SH295	(2) SH295	(3) SH295	(3) SH295
(Qty) Compressor Model Number Ckt B	(1) SH240	(1) SH240	(2) SH240	(2) SH240	(2) SH295	(3) SH240	(3) SH295	(3) SH240	(3) SH295
(Qty) Compressor Model Number Ckt C	N/A	N/A	N/A	N/A	N/A	N/A	N/A	N/A	N/A
Oil Charge (Pt, Ckt A/Ckt B/Ckt C)	26.2/13.1/ —	29.2/13.1/ —	26.2/26.2/ —	29.2/26.2/ —	29.2/29.2/ —	29.2/39.4/ —	29.2/43.8/ —	43.8/39.4/ —	43.8/43.8/ —
No. Capacity Steps									
Standard	3	3	4	4	4	5	5	6	6
Optional (Maximum)	4	4	5	5	5	6	6	7	7
Minimum Capacity Step (%)									
Standard	33	29	25	22	25	18	20	15	17
Optional	22	19	16	14	18	12	14	10	12
Capacity (%)									
Ckt A	67	71	50	56	50	45	40	56	50
Ckt B	33	29	50	44	50	55	60	44	50
Ckt C	N/A	N/A	N/A	N/A	N/A	N/A	N/A	N/A	N/A
<b>COOLER</b>									
Direct Expansion, Shell and Tube Type									
Weight (empty, lb)	715	715	856	856	856	970	970	970	1518
Net Fluid Volume (gal)	28.2	28.2	31.3	31.3	31.3	45.8	45.8	45.8	73.5
Maximum Refrigerant Pressure (psig)	445	445	445	445	445	445	445	445	445
Maximum Water-Side Pressure without Pumps (psig)	300	300	300	300	300	300	300	300	300
Maximum Water-Side Pressure with Pumps (psig)	150	150	150	150	150	150	150	150	150
<b>COOLER WATER CONNECTIONS (in.)</b>									
Inlet and Outlet, Victaulic	4	4	4	4	4	6	6	6	6
Drain (NPT)	3/4	3/4	3/4	3/4	3/4	3/4	3/4	3/4	3/4
<b>CONDENSER FANS</b>									
Shrouded Axial Type, Vertical Discharge									
Standard Low Noise Type									
Fan Speed (rpm) Standard	1140	1140	1140	1140	1140	1140	1140	1140	1140
No. Blades...Diameter (in.)	9...30	9...30	9...30	9...30	9...30	9...30	9...30	9...30	9...30
No. Fans (Ckt A/Ckt B/Ckt C)	3/1/—	3/1/—	2/2/—	3/3/—	3/3/—	3/3/—	3/4/—	4/4/—	4/4/—
<b>CONDENSER COILS</b>									
No. Coils (Ckt A/Ckt B/Ckt C)	3/1/—	3/1/—	2/2/—	3/3/—	3/3/—	3/3/—	3/4/—	4/4/—	4/4/—
Total Face Area (sq ft)	94	94	94	141	141	141	164	188	188
Max Working Refrigerant Pressure (psig)	656	656	656	656	656	656	656	656	656
<b>HYDRONIC MODULE (Optional)</b>									
Pump	Pump(s) with pressure/temperature taps and combination valve. Single or Dual, 1800 or 3600 rpm								
<b>CHASSIS DIMENSIONS (in.)</b>									
Length	94			141			188		
Width	88								
Height	90								

### LEGEND

**Al-Cu** — Aluminum Fin/Copper Tube Condenser Coil  
**Cu-Cu** — Copper Fin/Copper Tube Condenser Coil  
**EXV** — Electronic Expansion Valve  
**MCHX** — Microchannel Condenser Coil  
**N/A** — Not Applicable  
**RTPF** — Round Tube Plate Fin

\* Operating weight does not include any options.

† RTPF (Round Tube Plate Fin) includes both Al-Cu and Cu-Cu coils.

### NOTES:

- 30RB chillers with Greenspeed® intelligence are not available in unit sizes 060 and 070.
- No pumps are available for unit sizes 210-300 or 060-190 with high SCCR option.



### 30RB060-300 — ENGLISH (cont)

UNIT 30RB	160	170	190	210	225	250	275	300
<b>OPERATING WEIGHT (lb)*</b>								
Al-Cu Condenser Coil	10,266	10,601	12,013	13,734	14,067	15,468	16,915	18,306
Cu-Cu Condenser Coil	11,472	11,807	13,460	15,181	15,514	17,157	18,845	20,477
MCHX Condenser Coil	9,475	9,799	11,064	12,772	13,093	14,349	15,647	16,893
<b>REFRIGERANT TYPE†</b>								
Refrigerant Charge (lb)	R-410A, EXV Controlled System							
RTPF Coil, Ckt A/Ckt B/Ckt C	162/125/— 79/63/—	162/133/— 79/64/—	162/162/— 79/87/—	125/125/125 59/53/64	125/125/125 59/59/64	125/125/162 59/59/89	162/162/125 83/87/68	162/162/162 83/87/94
<b>COMPRESSORS</b>								
	Scroll, Hermetic							
Quantity	7	7	8	9	9	10	11	12
Speed (rpm)	3500							
(Qty) Compressor Model Number Ckt A	(4) SH295	(4) SH295	(4) SH295	(3) SH295	(3) SH295	(3) SH295	(4) SH295	(4) SH295
(Qty) Compressor Model Number Ckt B	(3) SH240	(3) SH295	(4) SH295	(3) SH240	(3) SH295	(3) SH295	(4) SH295	(4) SH295
(Qty) Compressor Model Number Ckt C	N/A	N/A	N/A	(3) SH295	(3) SH295	(4) SH295	(3) SH295	(4) SH295
Oil Charge (Pt, Ckt A/Ckt B/Ckt C)	58.4/39.4/—	58.4/43.8/—	58.4/58.4/—	43.8/39.4/ 43.8	43.8/43.8/ 43.8	43.8/43.8/ 58.4	58.4/58.4/ 43.8	58.4/58.4/ 58.4
No. Capacity Steps								
Standard	7	7	8	9	9	10	11	12
Optional (Maximum)	8	8	9	10	10	11	12	13
Minimum Capacity Step (%)								
Standard	13	14	13	10	11	10	9	8
Optional	8	10	9	6	8	7	7	6
Capacity (%)								
Ckt A	62	57	50	36	33	30	36	33
Ckt B	38	43	50	28	33	30	36	33
Ckt C	N/A	N/A	N/A	36	33	40	28	33
<b>COOLER</b>								
	Direct Expansion, Shell and Tube Type							
Weight (empty, lb)	1518	1518	1518	2382	2382	2382	2382	2382
Net Fluid Volume (gal)	73.5	73.5	73.5	86.6	86.6	86.6	86.6	86.6
Maximum Refrigerant Pressure (psig)	445	445	445	445	445	445	445	445
Maximum Water-Side Pressure without Pumps (psig)	300	300	300	300	300	300	300	300
Maximum Water-Side Pressure with Pumps (psig)	150	150	150	150	150	150	150	150
<b>COOLER WATER CONNECTIONS (in.)</b>								
Inlet and Outlet, Victaulic	6	6	6	6	6	6	6	6
Drain (NPT)	3/4	3/4	3/4	3/4	3/4	3/4	3/4	3/4
<b>CONDENSER FANS</b>								
	Shrouded Axial Type, Vertical Discharge							
Standard Low Noise Type								
Fan Speed (rpm) Standard	1140	1140	1140	1140	1140	1140	1140	1140
No. Blades...Diameter (in.)	9...30	9...30	9...30	9...30	9...30	9...30	9...30	9...30
No. Fans (Ckt A/Ckt B/Ckt C)	6/4/—	6/4/—	6/6/—	4/4/4	4/4/4	4/4/6	6/6/4	6/6/6
<b>CONDENSER COILS</b>								
No. Coils (Ckt A/Ckt B/Ckt C)	6/4/—	6/4/—	6/6/—	4/4/4	4/4/4	4/4/6	6/6/4	6/6/6
Total Face Area (sq ft)	235	235	282	282	282	328	375	422
Max Working Refrigerant Pressure (psig)	656	656	656	656	656	656	656	656
<b>HYDRONIC MODULE (Optional)</b>								
	Pump(s) with pressure/temperature taps and combination valve.							
Pump	Single or Dual, 1800 or 3600 rpm				Not available			
<b>CHASSIS DIMENSIONS (in.)</b>								
Length	235		282		329		376	
Width	88							
Height	90							

**LEGEND**

- Al-Cu — Aluminum Fin/Copper Tube Condenser Coil
- Cu-Cu — Copper Fin/Copper Tube Condenser Coil
- EXV — Electronic Expansion Valve
- MCHX — Microchannel Condenser Coil
- N/A — Not Applicable
- RTPF — Round Tube Plate Fin

\* Operating weight does not include any options.

† RTPF (Round Tube Plate Fin) includes both Al-Cu and Cu-Cu coils.

**NOTES:**

1. 30RB chillers with Greenspeed® intelligence are not available in unit sizes 060 and 070.
2. No pumps are available for unit sizes 210-300 or 060-190 with high SCCR option.

# Physical data (cont)



## 30RB060-300 — SI

UNIT 30RB	060	070	080	090	100	110	120	130	150	
<b>OPERATING WEIGHT (kg)*</b>										
Al-Cu Condenser Coil	1869	1962	2091	2697	2798	2963	3488	3649	4161	
Cu-Cu Condenser Coil	2088	2181	2310	3026	3127	3292	3871	4087	4599	
MCHX Condenser Coil	1716	1804	1934	2472	2569	2734	3229	3358	3863	
<b>REFRIGERANT TYPE†</b>										
R-410A, EXV Controlled System										
Refrigerant Charge (kg)										
RTPF Coil, Ckt A/Ckt B/Ckt C	40.7/15.5/—	42.7/15.5/—	31.1/31.1/—	42.6/34.5/—	42.6/43.6/—	42.6/48.1/—	42.6/60.3/—	60.3/48.1/—	60.3/60.3/—	
MCHX Coil, Ckt A/Ckt B/Ckt C	18.1/9.1/—	18.1/9.1/—	14.9/14.9/—	18.1/18.1/—	18.1/19.1/—	18.1/24.0/—	19.5/25.9/—	24.5/19.5/—	25.4/28.1/—	
<b>COMPRESSORS</b>										
Scroll, Hermetic										
Quantity	3	3	4	4	4	5	5	6	6	
Speed (r/s)	58.3									
(Qty) Compressor Model Number Ckt A	(2) SH240	(2) SH295	(2) SH240	(2) SH295	(2) SH295	(2) SH295	(2) SH295	(3) SH295	(3) SH295	
(Qty) Compressor Model Number Ckt B	(1) SH240	(1) SH240	(2) SH240	(2) SH240	(2) SH295	(3) SH240	(3) SH295	(3) SH240	(3) SH295	
(Qty) Compressor Model Number Ckt C	N/A	N/A	N/A	N/A	N/A	N/A	N/A	N/A	N/A	
Oil Charge (L, Ckt A/Ckt B/Ckt C)	12.4/6.2/—	13.8/6.2/—	12.4/12.4/—	13.8/12.4/—	13.8/13.8/—	13.8/18.6/—	13.8/20.7/—	20.7/18.6/—	20.7/20.7/—	
No. Capacity Steps										
Standard	3	3	4	4	4	5	5	6	6	
Optional (Maximum)	4	4	5	5	5	6	6	7	7	
Minimum Capacity Step (%)										
Standard	33	29	25	22	25	18	20	15	17	
Optional	22	19	16	14	18	12	14	10	12	
Capacity (%)										
Ckt A	67	71	50	56	50	45	40	56	50	
Ckt B	33	29	50	44	50	55	60	44	50	
Ckt C	N/A	N/A	N/A	N/A	N/A	N/A	N/A	N/A	N/A	
<b>COOLER</b>										
Direct Expansion, Shell and Tube Type										
Weight (empty, kg)	324	324	388	388	388	440	440	440	689	
Net Fluid Volume (L)	106	106	118	118	118	173	173	173	278	
Maximum Refrigerant Pressure (kPa)	3068	3068	3068	3068	3068	3068	3068	3068	3068	
Maximum Water-Side Pressure without Pumps (kPa)	2068	2068	2068	2068	2068	2068	2068	2068	2068	
Maximum Water-Side Pressure with Pumps (kPa)	1034	1034	1034	1034	1034	1034	1034	1034	1034	
<b>WATER CONNECTIONS (in.)</b>										
Inlet and Outlet, Victaulic	4	4	4	4	4	6	6	6	6	
Drain (NPT)	3/4	3/4	3/4	3/4	3/4	3/4	3/4	3/4	3/4	
<b>CONDENSER FANS</b>										
Shrouded Axial Type, Vertical Discharge										
Standard Low Noise Type										
Fan Speed (r/s) Standard	19	19	19	19	19	19	19	19	19	
No. Blades...Diameter (mm)	9...762	9...762	9...762	9...762	9...762	9...762	9...762	9...762	9...762	
No. Fans (Ckt A/Ckt B/Ckt C)	3/1/—	3/1/—	2/2/—	3/3/—	3/3/—	3/3/—	3/4/—	4/4/—	4/4/—	
<b>CONDENSER COILS</b>										
No. Coils (Ckt A/Ckt B/Ckt C)	3/1/—	3/1/—	2/2/—	3/3/—	3/3/—	3/3/—	3/4/—	4/4/—	4/4/—	
Total Face Area (sq m)	8.73	8.73	8.73	13.1	13.1	13.1	15.24	17.47	17.47	
Max Working Refrigeration Pressure (kPa)	4522	4522	4522	4522	4522	4522	4522	4522	4522	
<b>HYDRONIC MODULE (Optional)</b>										
Pump(s) with pressure/temperature taps and combination valve.										
Pump	Single or Dual, 29.2 or 58.3 r/s									
<b>CHASSIS DIMENSIONS (mm)</b>										
Length	2393		3587				4781			
Width	2236									
Height	2281									

### LEGEND

**Al-Cu** — Aluminum Fin/Copper Tube Condenser Coil  
**Cu-Cu** — Copper Fin/Copper Tube Condenser Coil  
**EXV** — Electronic Expansion Valve  
**MCHX** — Microchannel Condenser Coil  
**N/A** — Not Applicable  
**RTPF** — Round Tube Plate Fin

\* Operating weight does not include any options.

† RTPF (Round Tube Plate Fin) includes both Al-Cu and Cu-Cu coils.

### NOTES:

- 30RB chillers with Greenspeed® intelligence are not available in unit sizes 060 and 070.
- No pumps are available for unit sizes 210-300 or 060-190 with high SCCR option.





### 30RB060-300 — SI (cont)

UNIT 30RB	160	170	190	210	225	250	275	300
<b>OPERATING WEIGHT (kg)*</b>								
Al-Cu Condenser Coil	4666	4819	5461	6243	6394	7031	7686	8321
Cu-Cu Condenser Coil	5215	5367	6118	6901	7052	7799	8566	9308
MCHX Condenser Coil	4297	4443	5019	5793	5937	6509	7096	7659
<b>REFRIGERANT TYPE†</b>								
R-410A, EXV Controlled System								
Refrigerant Charge (kg)								
Std Coil, Ckt A/Ckt B/Ckt C	73.6/56.8/—	73.6/60.5/—	73.6/73.6/—	56.8/56.8/56.8	56.8/56.8/56.8	56.8/56.8/73.6	73.6/73.6/56.8	73.5/73.5/73.5
MCHX Coil, Ckt A/Ckt B/Ckt C	35.9/28.6/—	35.9/29.1/—	35.9/35.9/—	26.8/24.1/29.1	26.8/26.8/29.1	26.8/26.8/40.5	37.7/39.5/30.9	37.6/39.5/42.6
<b>COMPRESSORS</b>								
Scroll, Hermetic								
Quantity	7	7	8	9	9	10	11	12
Speed (r/s)	58.3							
(Qty) Compressor Model Number Ckt A	(4) SH295	(4) SH295	(4) SH295	(3) SH295	(3) SH295	(3) SH295	(4) SH295	(4) SH295
(Qty) Compressor Model Number Ckt B	(3) SH240	(3) SH295	(4) SH295	(3) SH240	(3) SH295	(3) SH295	(4) SH295	(4) SH295
(Qty) Compressor Model Number Ckt C	N/A	N/A	N/A	(3) SH295	(3) SH295	(4) SH295	(3) SH295	(4) SH295
Oil Charge (L, Ckt A/Ckt B/Ckt C)	27.6/18.6/—	27.6/20.7/—	27.6/27.6/—	20.7/18.6/20.7	20.7/20.7/20.7	20.7/20.7/27.6	27.6/27.6/20.7	27.6/27.6/27.6
<b>No. Capacity Steps</b>								
Standard	7	7	8	9	9	10	11	12
Optional (Maximum)	8	8	9	10	10	11	12	13
<b>Minimum Capacity Step (%)</b>								
Standard	13	14	13	10	11	10	9	8
Optional	8	10	9	6	8	7	7	6
<b>Capacity (%)</b>								
Ckt A	62	57	50	38	33	30	36	33
Ckt B	38	43	50	28	33	30	36	33
Ckt C	N/A	N/A	N/A	36	33	40	28	33
<b>COOLER</b>								
Direct Expansion, Shell and Tube Type								
Weight (empty, kg)	689	689	689	1080	1080	1080	1080	1080
Net Fluid Volume (L)	278	278	278	327	327	327	327	327
Maximum Refrigerant Pressure (kPa)	3068	3068	3068	3068	3068	3068	3068	3068
Maximum Water-Side Pressure without Pumps (kPa)	2068	2068	2068	2068	2068	2068	2068	2068
Maximum Water-Side Pressure with Pumps (kPa)	1034	1034	1034	1034	1034	1034	1034	1034
<b>WATER CONNECTIONS (in.)</b>								
Inlet and Outlet, Victaulic Drain (NPT)	6 3/4	6 3/4	6 3/4	6 3/4	6 3/4	6 3/4	6 3/4	6 3/4
<b>CONDENSER FANS</b>								
Shrouded Axial Type, Vertical Discharge								
Standard Low Noise Type								
Fan Speed (r/s) Standard	19	19	19	19	19	19	19	19
No. Blades...Diameter (mm)	9...762	9...762	9...762	9...762	9...762	9...762	9...762	9...762
No. Fans (Ckt A/Ckt B/Ckt C)	6/4/—	6/4/—	6/6/—	4/4/4	4/4/4	4/4/6	6/6/4	6/6/6
<b>CONDENSER COILS</b>								
No. Coils (Ckt A/Ckt B/Ckt C)	6/4/—	6/4/—	6/6/—	4/4/4	4/4/4	4/4/6	6/6/4	6/6/6
Total Face Area (sq m)	21.83	21.83	26.2	26.2	26.2	30.47	34.84	39.21
Max Working Refrigeration Pressure (kPa)	4522	4522	4522	4522	4522	4522	4522	4522
<b>HYDRONIC MODULE (Optional)</b>								
Pump	Pump(s) with pressure/temperature taps and combination valve.				Not available			
	Single or Dual, 29.2 or 58.3 r/s							
<b>CHASSIS DIMENSIONS (mm)</b>								
Length	5975			7169		8363	9557	10,751
Width	2236							
Height	2281							

**LEGEND**

- Al-Cu — Aluminum Fin/Copper Tube Condenser Coil
- Cu-Cu — Copper Fin/Copper Tube Condenser Coil
- EXV — Electronic Expansion Valve
- MCHX — Microchannel Condenser Coil
- N/A — Not Applicable
- RTPF — Round Tube Plate Fin

\* Operating weight does not include any options.

† RTPF (Round Tube Plate Fin) includes both Al-Cu and Cu-Cu coils.

**NOTES:**

1. 30RB chillers with Greenspeed® intelligence are not available in unit sizes 060 and 070.
2. No pumps are available for unit sizes 210-300 or 060-190 with high SCCR option.

## UNIT WEIGHTS — STANDARD UNITS

### AL/CU COIL UNITS WITHOUT PUMP — ENGLISH

UNIT 30RB	MOUNTING WEIGHT (lb) No Pump Al/Cu*				
	A	B	C	D	Total
060	869	913	1193	1136	4111
070	891	936	1275	1215	4317
080	982	958	1313	1346	4600
090	1159	1397	1845	1531	5932
100	1173	1431	1952	1600	6155
110	1319	1448	1964	1788	6519

UNIT 30RB	MOUNTING WEIGHT (lb) No Pump Al/Cu*						
	A	B	C	D	E	F	Total
120	731	1762	809	985	2347	1056	7,690
130	728	1850	818	1168	2531	949	8,045
150	893	2085	888	1228	2864	1217	9,174
160	1106	2189	1104	1483	2923	1463	10,266
170	1142	2220	1108	1487	3039	1606	10,601

UNIT 30RB	MOUNTING WEIGHT (lb) No Pump Al/Cu*									
	A	B	C	D	E	F	G	H	Total	
190	1094	1388	1484	1101	1479	2004	1938	1526	12,013	
210	916	1804	2139	853	1311	3044	2440	1228	13,734	
225	947	1836	2144	855	1313	3049	2569	1354	14,067	
250	1122	2271	2133	850	1307	3035	3166	1584	15,468	
275	627	2269	2805	1292	1866	3808	3169	1080	16,915	
300	899	2602	2792	1284	1859	3795	3640	1435	18,306	

### CU/CU COIL UNITS WITHOUT PUMP — ENGLISH

UNIT 30RB	MOUNTING WEIGHT (lb) No Pump Cu/Cu†				
	A	B	C	D	Total
060	992	1037	1311	1254	4,593
070	1014	1059	1393	1333	4,799
080	1106	1081	1431	1464	5,082
090	1342	1584	2020	1711	6,656
100	1355	1619	2126	1780	6,879
110	1503	1635	2139	1967	7,243

UNIT 30RB	MOUNTING WEIGHT (lb) No Pump Cu/Cu†						
	A	B	C	D	E	F	Total
120	837	1980	917	1088	2551	1161	8,534
130	850	2100	940	1288	2764	1069	9,010
150	1015	2334	1009	1348	3097	1336	10,139
160	1252	2497	1266	1642	3218	1599	11,472
170	1289	2528	1270	1645	3334	1742	11,807

UNIT 30RB	MOUNTING WEIGHT (lb) No Pump Cu/Cu†									
	A	B	C	D	E	F	G	H	Total	
190	1257	1595	1691	1263	1638	2199	2133	1684	13,460	
210	1018	2045	2410	978	1427	3297	2681	1326	15,181	
225	1049	2078	2415	981	1429	3301	2810	1452	15,514	
250	1283	2577	2404	976	1423	3288	3463	1744	17,157	
275	732	2554	3193	1501	2059	4185	3446	1175	18,845	
300	1064	2950	3179	1494	2053	4172	3974	1591	20,477	

### MCHX COIL UNITS WITHOUT PUMP — ENGLISH\*\*

UNIT 30RB	MOUNTING WEIGHT (lb) No Pump MCHX				
	A	B	C	D	Total
060	800	840	1098	1045	3,783
070	821	862	1175	1120	3,978
080	911	889	1218	1249	4,267
090	1065	1283	1695	1406	5,449
100	1079	1316	1796	1472	5,663
110	1219	1339	1816	1653	6,027

UNIT 30RB	MOUNTING WEIGHT (lb) No Pump MCHX†						
	A	B	C	D	E	F	Total
120	660	1614	737	915	2210	985	7,119
130	648	1683	738	1088	2377	870	7,402
150	810	1914	805	1146	2706	1136	8,517
160	1020	2020	1019	1368	2698	1350	9,475
170	1055	2052	1024	1374	2809	1485	9,799

UNIT 30RB	MOUNTING WEIGHT (lb) No Pump MCHX†									
	A	B	C	D	E	F	G	H	Total	
190	1007	1278	1367	1014	1362	1846	1785	1405	11,064	
210	852	1677	1989	793	1219	2831	2269	1142	12,772	
225	881	1709	1996	796	1222	2838	2391	1260	13,093	
250	1041	2107	1979	789	1212	2815	2937	1469	14,349	
275	580	2099	2594	1195	1726	3523	2931	999	15,647	
300	830	2401	2576	1185	1716	3502	3359	1324	16,893	

### AL/CU COIL UNITS WITHOUT PUMP — SI

UNIT 30RB	MOUNTING WEIGHT (kg) No Pump Al/Cu*				
	A	B	C	D	Total
060	395	415	542	516	1869
070	405	425	580	552	1962
080	447	436	597	612	2091
090	527	635	839	696	2697
100	533	650	887	727	2798
110	600	658	893	813	2963

UNIT 30RB	MOUNTING WEIGHT (kg) No Pump Al/Cu*						
	A	B	C	D	E	F	Total
120	332	799	367	447	1065	479	3488
130	330	839	371	530	1148	431	3649
150	405	946	403	557	1299	552	4161
160	503	995	502	674	1328	665	4666
170	519	1009	503	676	1381	730	4819

UNIT 30RB	MOUNTING WEIGHT (kg) No Pump Al/Cu*									
	A	B	C	D	E	F	G	H	Total	
190	497	631	674	500	672	911	881	694	5461	
210	416	820	972	388	596	1384	1109	558	6243	
225	431	835	975	389	597	1386	1168	615	6394	
250	510	1032	970	386	594	1380	1439	720	7031	
275	285	1032	1275	587	848	1731	1440	491	7689	
300	409	1183	1269	584	845	1725	1654	652	8321	

### CU/CU COIL UNITS WITHOUT PUMP — SI

UNIT 30RB	MOUNTING WEIGHT (kg) No Pump Cu/Cu†				
	A	B	C	D	Total
060	451	471	596	570	2088
070	461	481	633	606	2181
080	503	491	651	665	2310
090	610	720	918	778	3026
100	616	736	966	809	3127
110	683	743	972	894	3292

UNIT 30RB	MOUNTING WEIGHT (kg) No Pump Cu/Cu†						
	A	B	C	D	E	F	Total
120	380	898	416	494	1157	527	3871
130	386	952	426	584	1254	485	4087
150	461	1059	458	611	1405	606	4599
160	569	1135	575	746	1463	727	5215
170	586	1149	577	748	1516	792	5367

UNIT 30RB	MOUNTING WEIGHT (kg) No Pump Cu/Cu†									
	A	B	C	D	E	F	G	H	Total	
190	571	725	769	574	744	1000	970	765	6118	
210	463	930	1095	445	649	1498	1219	603	6901	
225	477	944	1098	446	650	1501	1277	660	7052	
250	583	1171	1093	444	647	1494	1574	793	7799	
275	333	1161	1451	682	936	1902	1566	534	8566	
300	484	1341	1445	679	933	1896	1807	723	9308	

### MCHX COIL UNITS WITHOUT PUMP — SI\*\*

UNIT 30RB	MOUNTING WEIGHT (kg) No Pump MCHX				
	A	B	C	D	Total
060	363	381	498	474	1716
070	372	391	533	508	1804
080	413	403	552	566	1934
090	483	582	769	638	2472
100	489	597	815	668	2569
110	553	607	824	750	2734

UNIT 30RB	MOUNTING WEIGHT (kg) No Pump MCHX†						
	A	B	C	D	E	F	Total
120	299	732	334	415	1002	447	3229
130	294	763	335	493	1078	394	3358
150	367	868	365	520	1227	515	3863
160	463	916	492	620	1224	612	4297
170	478	931	464	623	1274	673	4443

UNIT 30RB	MOUNTING WEIGHT (kg) No Pump MCHX†									
	A	B	C	D	E	F	G	H	Total	
190	457	580	620	460	618	837	810	637	5019	
210	386	761	902	360	553	1284	1029	518	5793	
225	400	775	905	361	554	1287	1084	571	5937	
250	472	956	898	358	550	1277	1332	666	6509	
275	263	952	1176	542	783	1598	1329	453	7096	
300	376	1089	1168	537	778	1588	1523	600	7659	

\*Condenser Coil: Aluminum Fins/Copper Tubing.

†Condenser Coil: Copper Fins/Copper Tubing.

\*\* Condenser Coil: Microchannel Design.

NOTE: 30RB chillers with Greenspeed® intelligence are not available in size 060 and 070.

## UNIT WEIGHTS — SINGLE PUMP UNITS

### AL/CU COIL UNITS WITH SINGLE PUMP — ENGLISH

UNIT 30RB	MOUNTING WEIGHT (lb) Single Pump Al/Cu*				
	A	B	C	D	Total
060	1085	1127	1230	1184	4626
070	1107	1150	1312	1263	4832
080	1193	1164	1354	1388	5100
090	1353	1620	1885	1575	6432
100	1366	1655	1991	1644	6655
110	1565	1653	1974	1868	7059

UNIT 30RB	MOUNTING WEIGHT (lb) Single Pump Al/Cu*						
	A	B	C	D	E	F	Total
120	731	2062	960	961	2460	1056	8,230
130	728	2149	969	1144	2645	949	8,585
150	893	2486	1031	1165	3035	1217	9,827
160	1238	2583	1104	1483	3155	1357	10,919
170	1279	2609	1108	1487	3276	1495	11,254

UNIT 30RB	MOUNTING WEIGHT (lb) Single Pump Al/Cu*								
	A	B	C	D	E	F	G	H	Total
190	1094	1510	1889	1101	1479	2178	1890	1526	12,666

### AL/CU COIL UNITS WITH SINGLE PUMP — SI

UNIT 30RB	MOUNTING WEIGHT (kg) Single Pump Al/Cu*				
	A	B	C	D	Total
060	493	512	559	538	2103
070	503	523	597	574	2196
080	542	529	616	631	2318
090	615	736	857	716	2924
100	621	752	905	747	3025
110	711	751	897	849	3209

UNIT 30RB	MOUNTING WEIGHT (kg) Single Pump Al/Cu*						
	A	B	C	D	E	F	Total
120	332	935	435	436	1116	479	3733
130	330	975	440	519	1200	431	3894
150	405	1128	468	528	1377	552	4458
160	563	1174	502	674	1434	617	4963
170	582	1186	503	676	1489	679	5116

UNIT 30RB	MOUNTING WEIGHT (kg) Single Pump Al/Cu*								
	A	B	C	D	E	F	G	H	Total
190	497	686	858	500	672	990	859	694	5757

### CU/CU COIL UNITS WITH SINGLE PUMP — ENGLISH

UNIT 30RB	MOUNTING WEIGHT (lb) Single Pump Cu/Cu†				
	A	B	C	D	Total
060	1208	1250	1348	1302	5,108
070	1230	1273	1430	1381	5,314
080	1317	1287	1472	1506	5,582
090	1537	1806	2060	1753	7,156
100	1549	1841	2166	1823	7,379
110	1749	1839	2150	2045	7,783

UNIT 30RB	MOUNTING WEIGHT (lb) Single Pump Cu/Cu†						
	A	B	C	D	E	F	Total
120	837	2280	1068	1065	2664	1161	9,074
130	850	2399	1091	1264	2877	1069	9,550
150	1015	2735	1153	1284	3269	1336	10,792
160	1382	2894	1266	1642	3447	1495	12,125
170	1424	2920	1270	1645	3569	1633	12,460

UNIT 30RB	MOUNTING WEIGHT (lb) Single Pump Cu/Cu†								
	A	B	C	D	E	F	G	H	Total
190	1257	1718	2095	1263	1638	2374	2084	1684	14,113

### CU/CU COIL UNITS WITH SINGLE PUMP — ENGLISH

UNIT 30RB	MOUNTING WEIGHT (kg) Single Pump Cu/Cu†				
	A	B	C	D	Total
060	549	568	613	592	2322
070	559	579	650	628	2415
080	599	585	669	684	2537
090	699	821	937	797	3253
100	704	837	985	828	3354
110	795	836	977	930	3538

UNIT 30RB	MOUNTING WEIGHT (kg) Single Pump Cu/Cu†						
	A	B	C	D	E	F	Total
120	380	1034	484	483	1209	527	4116
130	386	1088	495	573	1305	485	4332
150	461	1241	523	583	1483	606	4895
160	628	1315	575	746	1567	680	5511
170	647	1327	577	748	1622	742	5664

UNIT 30RB	MOUNTING WEIGHT (kg) Single Pump Cu/Cu†								
	A	B	C	D	E	F	G	H	Total
190	571	781	952	574	744	1079	947	765	6415

### MCHX COIL UNITS WITH SINGLE PUMP — ENGLISH

UNIT 30RB	MOUNTING WEIGHT (lb) Single Pump MCHX*				
	A	B	C	D	Total
060	1008	1047	1143	1100	4298
070	1030	1069	1220	1174	4493
080	1115	1088	1266	1298	4767
090	1251	1498	1743	1457	5949
100	1265	1532	1844	1522	6163
110	1456	1537	1836	1738	6567

UNIT 30RB	MOUNTING WEIGHT (lb) Single Pump MCHX**						
	A	B	C	D	E	F	Total
120	660	1914	887	891	2322	985	7,659
130	648	1982	888	1064	2490	870	7,942
150	810	2316	948	1083	2877	1136	9,170
160	1148	2395	1024	1376	2926	1259	10,128
170	1188	2423	1029	1381	3043	1388	10,452

UNIT 30RB	MOUNTING WEIGHT (lb) Single Pump MCHX**								
	A	B	C	D	E	F	G	H	Total
190	1012	1396	1747	1019	1368	2015	1748	1412	11,717

### MCHX COIL UNITS WITH SINGLE PUMP — SI

UNIT 30RB	MOUNTING WEIGHT (kg) Single Pump MCHX*				
	A	B	C	D	Total
060	457	475	518	499	1949
070	467	485	553	532	2037
080	506	493	574	589	2162
090	567	679	790	661	2697
100	574	695	836	690	2795
110	660	697	833	788	2978

UNIT 30RB	MOUNTING WEIGHT (kg) Single Pump MCHX**						
	A	B	C	D	E	F	Total
120	299	868	402	404	1053	447	3474
130	294	899	403	483	1129	394	3603
150	367	1051	430	491	1305	515	4160
160	521	1086	464	624	1327	571	4593
170	539	1099	467	626	1380	629	4740

UNIT 30RB	MOUNTING WEIGHT (kg) Single Pump MCHX**								
	A	B	C	D	E	F	G	H	Total
190	459	633	792	462	620	914	763	640	5313

\* Condenser Coil: Aluminum Fins/Copper Tubing.

† Condenser Coil: Copper Fins/Copper Tubing.

\*\* Condenser Coil: Microchannel Design.

NOTE: 30RB chillers with Greenspeed intelligence are not available in size 060 and 070.

# AIRE ACONDICIONADO

## UNIT WEIGHTS — DUAL PUMP UNITS

### AL/CU COIL UNITS WITH DUAL PUMP — ENGLISH

UNIT 30RB	MOUNTING WEIGHT (lb) Dual Pump Al/Cu*				
	A	B	C	D	Total
060	1218	1259	1254	1213	4,944
070	1240	1281	1336	1293	5,150
080	1372	1339	1389	1424	5,523
090	1518	1808	1919	1611	6,855
100	1530	1843	2025	1680	7,078
110	1741	1796	1983	1922	7,442

UNIT 30RB	MOUNTING WEIGHT (lb) Dual Pump Al/Cu*						
	A	B	C	D	E	Total	
120	731	2281	1061	951	2534	1056	8,613
130	728	2367	1071	1133	2719	949	8,968
150	893	2864	1147	1122	3177	1217	10,419
160	1336	2962	1104	1483	3344	1282	11,511
170	1383	2983	1108	1487	3471	1415	11,846

UNIT 30RB	MOUNTING WEIGHT (lb) Dual Pump Al/Cu*								
	A	B	C	D	E	F	G	H	Total
190	1094	1588	2288	1101	1479	2303	1879	1526	13,258

### AL/CU COIL UNITS WITH DUAL PUMP — SI

UNIT 30RB	MOUNTING WEIGHT (kg) Dual Pump Al/Cu*				
	A	B	C	D	Total
060	554	572	570	552	2247
070	564	582	607	588	2341
080	624	609	631	647	2511
090	690	822	872	732	3116
100	695	838	920	764	3217
110	791	817	901	874	3383

UNIT 30RB	MOUNTING WEIGHT (kg) Dual Pump Al/Cu*						
	A	B	C	D	E	Total	
120	332	1035	481	431	1149	479	3907
130	330	1074	486	514	1233	431	4068
150	405	1299	520	509	1441	552	4726
160	607	1347	502	674	1520	583	5232
170	629	1356	503	676	1578	643	5385

UNIT 30RB	MOUNTING WEIGHT (kg) Dual Pump Al/Cu*								
	A	B	C	D	E	F	G	H	Total
190	497	722	1040	500	672	1047	854	1526	6014

### CU/CU COIL UNITS WITH DUAL PUMP — ENGLISH

UNIT 30RB	MOUNTING WEIGHT (lb) Dual Pump Cu/Cu†				
	A	B	C	D	Total
060	1341	1382	1371	1331	5,426
070	1363	1405	1453	1411	5,632
080	1495	1462	1507	1541	6,005
090	1702	1994	2095	1788	7,579
100	1714	2030	2201	1858	7,802
110	1926	1982	2160	2099	8,166

UNIT 30RB	MOUNTING WEIGHT (lb) Dual Pump Cu/Cu†						
	A	B	C	D	E	Total	
120	837	2498	1169	1054	2739	1161	9,457
130	850	2616	1193	1252	2953	1069	9,933
150	1015	3112	1270	1240	3411	1336	11,384
160	1481	3273	1266	1642	3637	1420	12,717
170	1527	3294	1270	1645	3763	1553	13,052

UNIT 30RB	MOUNTING WEIGHT (lb) Dual Pump Cu/Cu†								
	A	B	C	D	E	F	G	H	Total
190	1257	1799	2492	1263	1638	2502	2071	1684	14,705

### CU/CU COIL UNITS WITH DUAL PUMP — SI

UNIT 30RB	MOUNTING WEIGHT (kg) Dual Pump Cu/Cu†				
	A	B	C	D	Total
060	610	628	623	605	2466
070	620	638	661	641	2560
080	680	665	685	701	2730
090	774	906	952	813	3445
100	779	923	1000	845	3547
110	875	901	982	954	3712

UNIT 30RB	MOUNTING WEIGHT (kg) Dual Pump Cu/Cu†						
	A	B	C	D	E	Total	
120	380	1133	530	478	1242	527	4290
130	386	1187	541	568	1339	485	4506
150	461	1412	576	562	1547	606	5164
160	673	1488	575	746	1653	646	5781
170	694	1497	577	748	1710	706	5933

UNIT 30RB	MOUNTING WEIGHT (kg) Dual Pump Cu/Cu†								
	A	B	C	D	E	F	G	H	Total
190	571	818	1133	574	744	1137	941	1684	6669

### MCHX COIL UNITS WITH DUAL PUMP — ENGLISH

UNIT 30RB	MOUNTING WEIGHT (lb) Dual Pump MCHX**				
	A	B	C	D	Total
060	1137	1175	1171	1133	4,616
070	1158	1197	1248	1208	4,811
080	1289	1258	1305	1338	5,190
090	1411	1680	1784	1497	6,372
100	1424	1715	1884	1563	6,586
110	1626	1677	1852	1795	6,950

UNIT 30RB	MOUNTING WEIGHT (lb) Dual Pump MCHX**						
	A	B	C	D	E	Total	
120	660	2134	987	882	2396	985	8,042
130	648	2201	989	1054	2564	870	8,325
150	810	2695	1063	1041	3017	1136	9,762
160	1244	2759	1028	1381	3114	1194	10,720
170	1289	2781	1033	1386	3236	1319	11,044

UNIT 30RB	MOUNTING WEIGHT (lb) Dual Pump MCHX**								
	A	B	C	D	E	F	G	H	Total
190	1016	1474	2124	1022	1373	2138	1745	1417	12,309

### MCHX COIL UNITS WITH DUAL PUMP — SI

UNIT 30RB	MOUNTING WEIGHT (kg) Dual Pump MCHX**				
	A	B	C	D	Total
060	516	533	531	514	2094
070	525	543	566	548	2182
080	585	571	592	607	2355
090	640	762	809	679	2890
100	646	778	854	709	2987
110	737	761	840	814	3152

UNIT 30RB	MOUNTING WEIGHT (kg) Dual Pump MCHX**						
	A	B	C	D	E	Total	
120	299	968	448	400	1087	447	3648
130	294	998	449	478	1163	394	3776
150	367	1223	482	472	1368	515	4428
160	564	1251	466	626	1412	541	4860
170	585	1261	468	629	1468	598	5009

UNIT 30RB	MOUNTING WEIGHT (kg) Dual Pump MCHX**								
	A	B	C	D	E	F	G	H	Total
190	461	668	963	463	623	970	791	643	5582

\* Condenser Coil: Aluminum Fins/Copper Tubing.

† Condenser Coil: Copper Fins/Copper Tubing.

\*\* Condenser Coil: Microchannel Design.

NOTE: 30RB chillers with Greenspeed intelligence are not available in size 060 and 070.



**30RB060-110\***

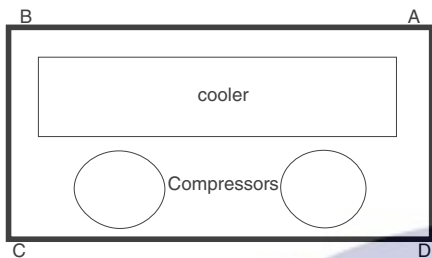

**30RB120-150**

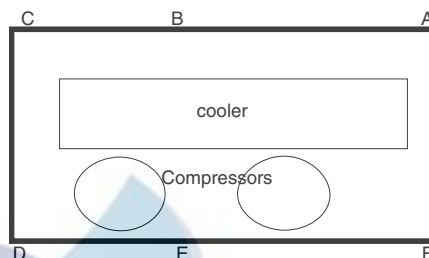

**30RB160, 170**

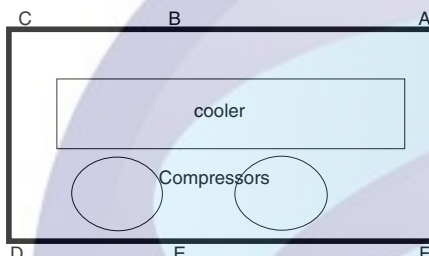

**30RB190-300**

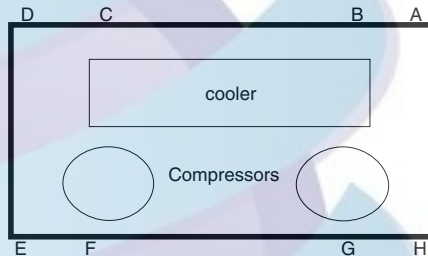

\*30RB chillers with Greenspeed® intelligence are not available in size 060 and 070.

NOTE: Mounting weights are calculated at mounting locations. Refer to certified drawings starting on page 17 for mounting locations.

**IEEGCSA**  
**AIRE ACONDICIONADO**

# Options and accessories



ITEM	FACTORY-INSTALLED OPTION	FIELD-INSTALLED ACCESSORY
<b>Condenser Coil Options</b>		
MCHX E-Coated	X	
Aluminum Fin/Copper Tube	X	
Aluminum Fin/Copper Tube, Pre-Coated	X	
Aluminum Fin/Copper Tube, E-Coated	X	
Copper Fin/Copper Tube, E-Coated	X	
Copper Fin/Copper Tube Condenser Coils	X	
<b>Controls/Communication Options</b>		
BACnet Communication	X	
BACnet/Modbus Translator Control	X	X
Chillervisor System Manager III Multi-Unit Control		X
Energy Management Module (EMM)	X	X
LON (Local Operating Network) Translator Control	X	X
Navigator™ Display		X
Remote Service Port		X
Remote Enhanced Display		X
Touch Pilot™ Display		X
Dual Chiller Accessory Kit		X
<b>Cooler Options</b>		
Freeze Protection - Cooler Heaters	X	
Remote Cooler		X
CRN Cooler (Canada Only)	X	
<b>Electrical/Low Sound Options</b>		
Unit-Mounted Main Disconnect, Non-Fused	X	
Convenience Outlet (not available at 380 volt)	X	X
High SCCR (includes non-fused disconnect)(460 v only)	X	
Low Sound - Compressor Sound Reduction Blankets	X	
Ultra Low Sound - Compressor Sound Reduction Enclosures	X	
<b>Hydronics Option</b>		
Hydronic Pump Package (available on unit sizes 060-190 only via ETO, not available with high SCCR)	X	
<b>Refrigeration Circuit Options</b>		
High-Efficiency Variable Condenser Fans (not available on unit sizes 060 and 070)	X	
Compressor Suction Service Valve	X	
Low Ambient Temperature Head Pressure Control (not available with high-efficiency variable condenser fans)	X	X
Minimum Load Control (not available with Leaving Fluid Temperature < 38°F [< 3.3°C])	X	X
Suction Line Insulation	X	
<b>Security/Packaging Options</b>		
Condenser Coil Trim Panels	X	X
Security Grilles	X	X
Full Hail Guard		X
Upper Hail Guard	X	
Full End Screen	X	

## LEGEND

<b>E-Coated</b>	— Epoxy Coating Applied to Entire Coil Assembly
<b>EMM</b>	— Energy Management Module
<b>LON</b>	— Local Operating Network
<b>MCHX</b>	— Microchannel Heat Exchanger

## NOTES:

1. Std SCCR (short circuit current rating) (5 kA).
2. High SCCR 460 v (65 kA).

## Factory-installed options

**Condenser coil** options are available to match coil construction to the site conditions for the best durability. Refer to the Condenser Coil Corrosion Protection Options table on page 16 or the appropriate selection guide for more information.

**Compressor suction service valve** provides additional isolation of the compressor from the cooler vessel for service. Standard refrigerant discharge isolation and liquid valves enable service personnel to store the refrigerant charge in the cooler or condenser during servicing.

**Suction line insulation** is tubular, closed-cell insulation. This option is required on applications with leaving fluid temperatures below 30°F (-1.1°C) and recommended for

areas of high dewpoints where condensation may be a concern.

**Hydronic pump package** option adds circulating pumps, a combination valve (isolation, modulation and check), strainer, Victaulic field piping connections, insulation and heaters, and pressure/temperature taps (3). The pumps are available in single or dual (lead/lag controlled) cooler pump versions with total dynamic head external to the chiller from approximately 20 to 140 ft (6.1 m to 42.7 m). Also includes heater and insulation for freeze protection to -20°F (-29°C). The hydronic pump package is available for sizes 060-190 and cannot be used in conjunction with units with high SCCR option.

**High-efficiency variable condenser fans** control the speed of all fans for improvement in part load efficiency and sound levels. Additionally, high-efficiency variable condenser fans maintain head pressure control down to -20°F (-29°C)

ambient temperature with the use of glycol and wind baffles. Varying the speed of all fans on a circuit to a prescribed speed provides accurate head pressure control to the most efficient point while achieving optimum usage of the coils to accomplish excellent part load efficiency. These fans are the key component of the 30RB chiller with Greenspeed® intelligence. This option is not available on unit sizes 060 and 070.

**Low ambient temperature head pressure control** permits operation of the 30RB units to  $-20^{\circ}\text{F}$  ( $-29^{\circ}\text{C}$ ) outdoor ambient temperature. The control is also available as a field-installed accessory and requires field-installed wind baffles. (This option or accessory is neither required nor available with the high-efficiency variable condenser fan option.)

**CRN cooler (Canada only)** provides minor cooler modifications to meet Canadian code.

**Unit-mounted non-fused disconnect** option provides non-fused disconnect capability for power and control located at the unit. On dual point power applications, this option is not available on 30RB060-120. This option is included with the high SCCR option.

**Minimum load control** option allows additional capacity reduction for unit operation below the minimum step of unloading (down to 6% of the full load unit capacity, depending on unit size). Minimum load control is also available as a field-installed accessory. This option is not available on applications with leaving fluid temperature less than  $38^{\circ}\text{F}$  ( $3.3^{\circ}\text{C}$ ).

**Security grilles** protect the condenser coil from damage with coated wire grilles with openings of 1 by 4 in. (25 mm x 102 mm). The security grille option requires the condenser coil trim panel option. Security grilles are also available as a field-installed accessory.

**Condenser coil trim panels** provide an aesthetic, finished appearance for the condenser coil ends of the cooler/pump connection side of the unit. Condenser coil trim panels are also available as a field-installed accessory.

**Upper hail guard** consists of louvered panels on the ends of the machine, which firmly fasten to the machine frame and provide coverage from the top of the unit to the bottom of the coil. A hinged accessory hail guard is also available. The accessory covers the entire unit end (both ends), and, with its hinged design, is not identical to this option.

**Full end screen** consists of louvered panels on the ends of the machine, providing complete coverage from the top to the bottom of the unit. This option functions as both a privacy screen and a hail guard. For hail protection, an accessory hail guard is also available. The accessory covers the entire unit end (both ends), and, with its hinged design, is not identical to this option.

**High SCCR** (short circuit current rating) devices allow the chiller to tolerate a 65 kA short circuit current for a brief period of time while protecting downstream components. The high SCCR provides a higher level of protection than the standard chiller components. This option is not available on 30RB250-300. It is available only at 460 v and includes the unit-mounted non-fused disconnect option. The standard SCCR rating for all models is 5 kA.

**Low sound - compressor sound blankets** reduce unit sound levels by providing an acoustic blanket on each compressor.

**Ultra low sound - compressor sound enclosures** provide enclosures which encase compressors that are covered with acoustic blankets.

**Energy management module** provides energy management capabilities to minimize chiller energy consumption. Several features are provided with this module including leaving fluid temperature reset, cooling set point reset or demand limit control from a 4 to 20 mA signal, 2-step demand limit control (from 0 to 100%) activated by a remote contact closure (one-step demand limit does not require the energy management module), and discrete input for “Ice Done” indication for ice stage system interface.

**Convenience outlet** includes a 4-amp GFI (ground fault interrupt) receptacle with independent fuse protection. Convenience outlet is a 115-v female receptacle.

**BACnet communication option** provides pre-programmed factory-installed communication capability with a BACnet MS/TP network. Allows integration with i-Vu® Open control system or a third-party BACnet building automation system. No field programming is required.

**BACnet/Modbus translator control** provides an interface between the chiller and a BACnet Local Area Network (LAN, i.e., MS/TP EIA-485). Field programming is required.

**LON translator control** provides an interface between the chiller and a Local Operating Network (LON, i.e., LonWorks FT-10A ANSI/EIA-709.1). Field programming is required.

#### Field-installed accessories

**Minimum load control** accessory allows additional capacity reduction for unit operation below the minimum step of unloading (down to 6% of the minimum unit capacity, depending on unit size) via hot gas bypass. This accessory is not available on applications with leaving fluid temperature less than  $38^{\circ}\text{F}$  ( $3.3^{\circ}\text{C}$ ).

**Full hail guard** consists of hinged, louvered panels, which cover both ends of the unit. This accessory provides complete protection from hail and flying debris. For hail protection, two factory options are also available. These options directly fasten to the end of the chillers (are not hinged), and therefore are not identical to this accessory.

**Navigator™ display** accessory provides a portable handheld display for convenient access to unit status, operation, configuration and troubleshooting diagnostics capability. The four-line, 80-character LCD display provides clear language information in English, French, Spanish, or Portuguese. The weatherproof enclosure and industrial grade extension cord enables the Navigator display to be ideally suited for outdoor applications. Magnets located on the back of the module allow attachment to any sheet metal component for hands-free operation.

**Remote enhanced display** accessory kit contains a remotely mounted indoor 40-character per line, 16-line display panel for unit diagnostics.

**Touch Pilot™ display** used as an accessory is a cost-effective, touch-screen, remote-mount device.

**Chillervisor System Manager III multi-unit control** accessory allows sequencing of between two and eight chillers in parallel. Pump control is also provided.

**Low ambient temperature head pressure control** permits operation of the 30RB units to  $-20^{\circ}\text{F}$  ( $-29^{\circ}\text{C}$ ) outdoor ambient temperature. The control is also available as a factory-installed option and requires field-installed wind baffles. (This option or accessory is neither required nor available with the high-efficiency variable speed fan option.)

**Energy management module** provides energy management capabilities to minimize chiller energy consumption. Several features are provided with this module including leaving fluid temperature reset, cooling set point reset or demand limit control from a 4 to 20 mA signal, 2-step demand limit control (from 0 to 100%) activated by a remote contact closure (one-step demand limit does not require the energy management module), and discrete input for “Ice Done” indication for ice stage system interface.

**Remote service port** consists of a receptacle for Navigator connection. The port is housed in a waterproof enclosure conveniently located for easy access to information during operation and maintenance routines.

**Convenience outlet** includes a 4-amp GFI (ground fault interrupt) receptacle with independent fuse protection. Convenience outlet is a 115-v female receptacle.

**Remote cooler** accessory provides the additional hardware required to remotely mount the cooler from the unit. The cooler-unit separation is limited to 75 equivalent feet. The remote cooler accessory cannot be used with MCHX condenser coils or in brine applications. Never bury refrigerant piping on these or any other applications.

**BACnet/Modbus translator control** provides an interface between the chiller and a BACnet Local Area Network (LAN, i.e., MS/TP EIA-485). Field programming is required.

**LON translator control** provides an interface between the chiller and a Local Operating Network (LON, i.e., LonWorks FT-10A ANSI/EIA-709.1). Field programming is required.

**Security grilles** protect the condenser coil from damage with coated wire grilles and openings of 1 by 4 in. (25 mm x 102 mm). The security grille accessory requires the condenser coil trim panel accessory. Security grilles are also available as a factory-installed option.

**Condenser coil trim panels** provide an aesthetic, finished appearance for the condenser coil ends of the cooler/pump connection side of the unit. Condenser coil trim panels are also available as a factory-installed option.

**Dual chiller accessory kit** provides the additional hardware (thermistors, wells, connectors) required for applications with 2 chillers running in parallel.

## CONDENSER COIL CORROSION PROTECTION OPTIONS

ENVIRO-SHIELD™ OPTION*	ENVIRONMENT				
	Standard	Mild Coastal	Severe Coastal	Industrial	Combined Industrial/Coastal
Novation® Heat Exchanger (Standard)	See NACO Packaged Chiller Builder				
Novation Heat Exchanger, E-coat	See NACO Packaged Chiller Builder				
AL Fins	X				
CU Fins		X			
AL Fins, E-coat			X	X	X
CU Fins, E-coat			X		
AL Fins, Pre-coated		X			

**LEGEND**

- AL — Aluminum
- CU — Copper
- NACO — North American Commercial Operations

\* See NACO Packaged Chiller Builder for details. Additional corrosion protection is available. For Novation or round tube/plate fin (RTPF) heat exchangers, see selection guide “Environmental Corrosion Protection” (Publication 04-581061-01).





## 30RB060, 070 AIR-COOLED CHILLER

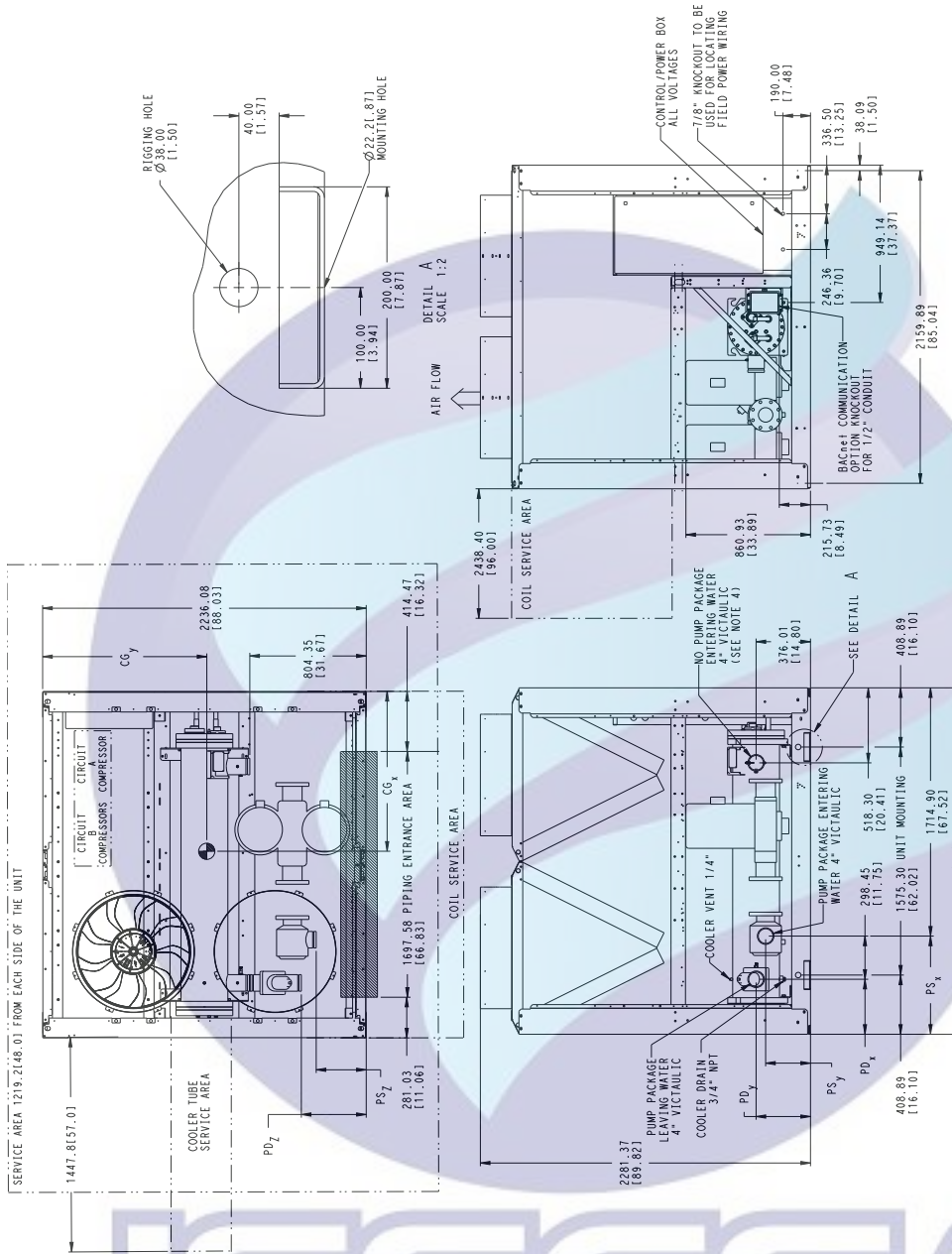

- NOTES:**
- Unit must have clearances as follows:  
 Top — Do not restrict.  
 Sides and End — 6' (1.8 m) from solid surface for air flow.  
 Side — 8' (2.4 m) required for coil service area.  
 All pumps have drains located at the bottom of volute for draining.
  - Temperature relief devices located on suction line, liquid line and filter drier of each circuit and have 1/4" flare connection.
  - Units without a pump package have the same leaving water, connection, Y and Z dimensions as units with a pump package.
  - Dimensions are in mm [inches].

WEIGHT CU/AL LB/TA	WEIGHT PUMP LB/TA	WEIGHT CU/CO LB/TA	WEIGHT MCHX PUMP LB/TA	MAX WEIGHT CU/CO PUMP LB/TA	CENTER OF GRAVITY			PUMP SUCTION (PS)			PUMP DISCHARGE (PD)			
					CGX MM	CGY MM	CGZ MM	X	Y	Z	X	Y	Z	
30RB-060	4111	4944	4593	5426	3163	4616	1164	1038	675.6	309.9	353.1	381.0	482.6	188.0
	1889	2247	2088	2466	1716	2094	145.821	140.861	126.6	132.2	135.9	115.0	119.0	77.4
30RB-070	3117	5150	4799	5632	3378	4811	1165	1073	675.6	309.9	353.1	381.0	482.6	188.0
	1932	2841	2781	3290	1864	2182	145.881	139.881	126.6	132.2	135.9	115.0	119.0	77.4

LEGEND  
MCHX — Microchannel Condenser Coil

## 30RB080 AIR-COOLED CHILLER

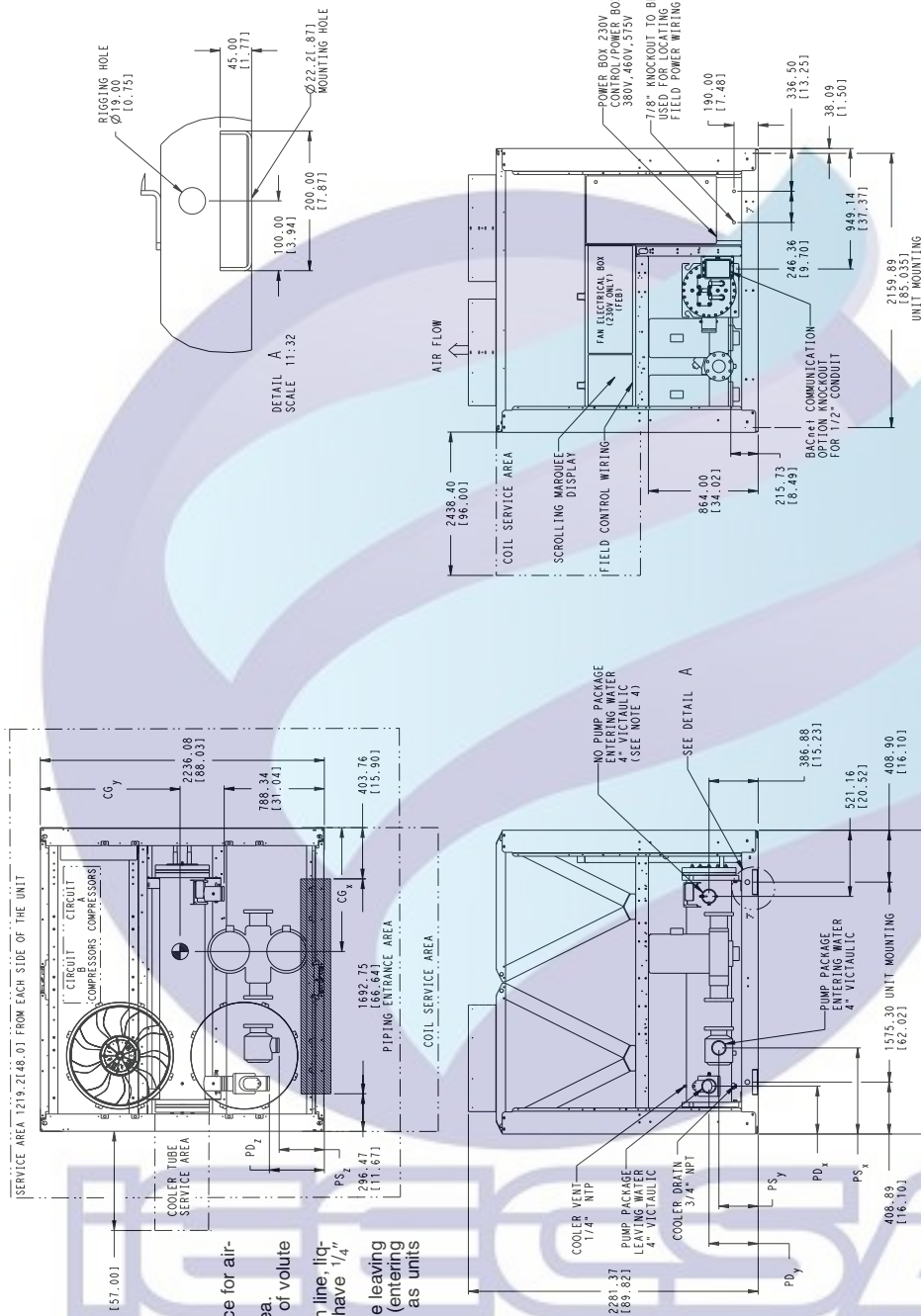

- NOTES:**
1. Unit must have clearances as follows:  
 Top — Do not restrict.  
 Sides and End — 6' (1.8 m) from solid surface for air flow.  
 Side — 8' (2.4 m) required for coil service area.  
 All pumps have drains located at the bottom of volute for draining.
  2. Temperature relief devices located on suction line, liquid line and filter drier of each circuit and have 1/4" flare connection.
  3. Units without a pump package have the same leaving water connection, Y and Z dimensions (entering water), and Pump Discharge X dimensions as units with a pump package.
  4. Dimensions are in mm [inches].

HEIGHT CU/AL lb/kg	WEIGHT CU/AL lb/kg	HEIGHT CU/AL lb/kg	WEIGHT CU/AL lb/kg	HEIGHT CU/AL lb/kg	WEIGHT CU/AL lb/kg	PUMP SUCTION (PSI)			PUMP DISCHARGE (PSI)		
						CG <sub>x</sub> MM [INCH]	Y MM [INCH]	Z MM [INCH]	X <sub>1</sub> MM [INCH]	Y <sub>1</sub> MM [INCH]	Z <sub>1</sub> MM [INCH]
30RB-080	4600	5823	5082	1206	1012	675.6	309.9	353.1	381.0	497.8	170.2
	2091	2511	2310	2730	1934	236.6	126.6	147.48	139.84	155.01	66.71

**LEGEND**  
 MCHX — Microchannel Condenser Coil

### 30RB090, 100 AIR-COOLED CHILLER

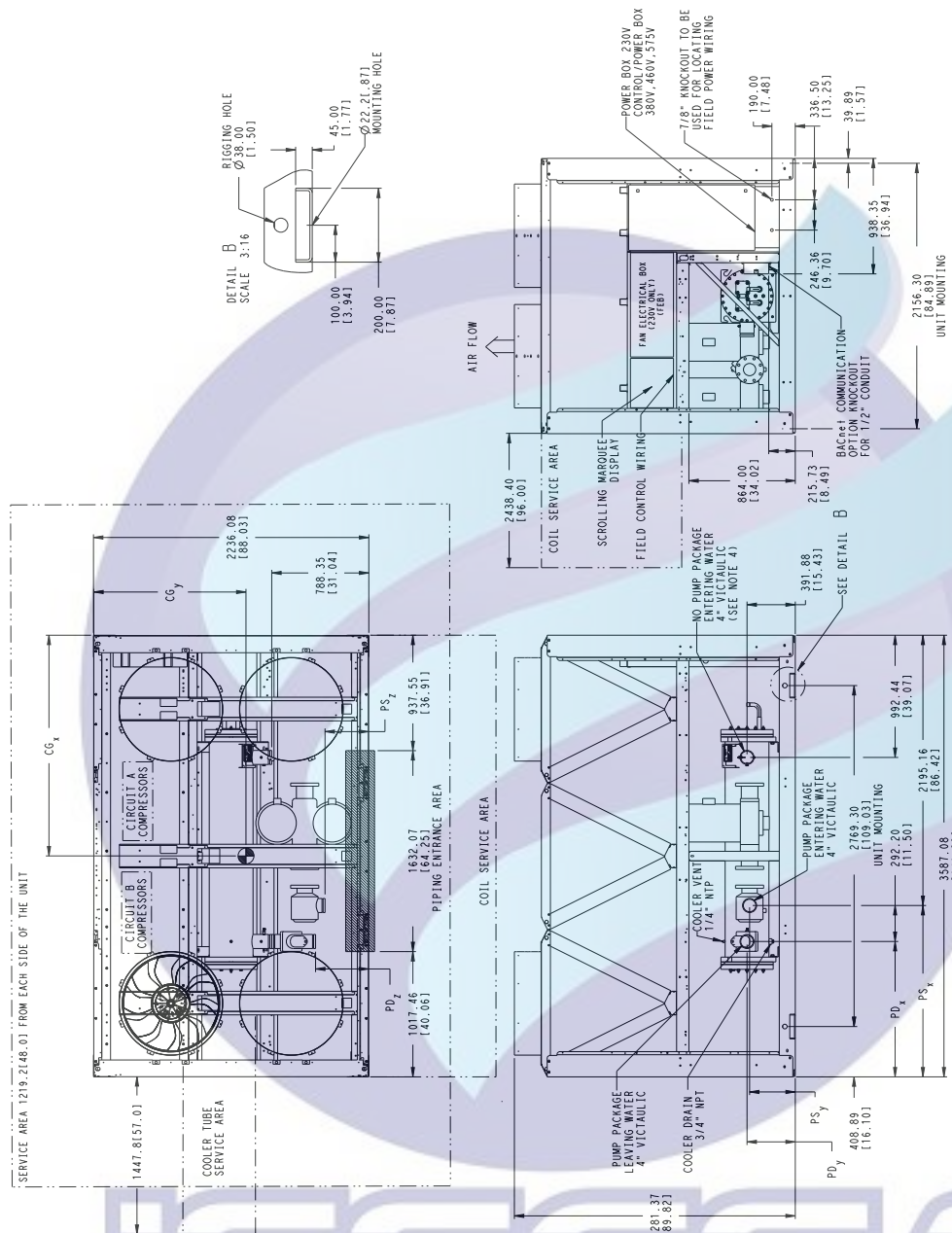

- NOTES:**
- Unit must have clearances as follows:  
 Top — Do not restrict.  
 Sides and End — 6' (1.8 m) from solid surface for airflow.  
 Side — 8' (2.4 m) required for coil service area.
  - All pumps have drains located at the bottom of volute for draining.
  - Temperature relief devices located on suction line, liquid line and filter drier of each circuit and have 1/4" flare connection.
  - Units without a pump package have the same leaving water connection, Y and Z dimensions (entering water), and Pump Discharge X dimensions as units with a pump package.
  - Dimensions are in mm [inches].

WEIGHT	MAX. WEIGHT	WEIGHT	MAX. WEIGHT	PUMP SUCTION (P.S.)			PUMP DISCHARGE (P.D.)		
				CU/CU	CU/CU	CU/CU	CU/CU	CU/CU	CU/CU
lb/kg	lb/kg	lb/kg	lb/kg	lb/kg	lb/kg	lb/kg	lb/kg	lb/kg	
5932	6655	7519	5449	6372	7300	8228	9156	10084	
2697	3116	3445	2472	2860	3311	3762	4213	4664	
6155	7078	8002	2463	2860	3311	3762	4213	4664	
2798	3117	3541	2593	2990	3441	3892	4343	4794	

**LEGEND**  
 MCHX — Microchannel Condenser Coil

## 30RB110 AIR-COOLED CHILLER

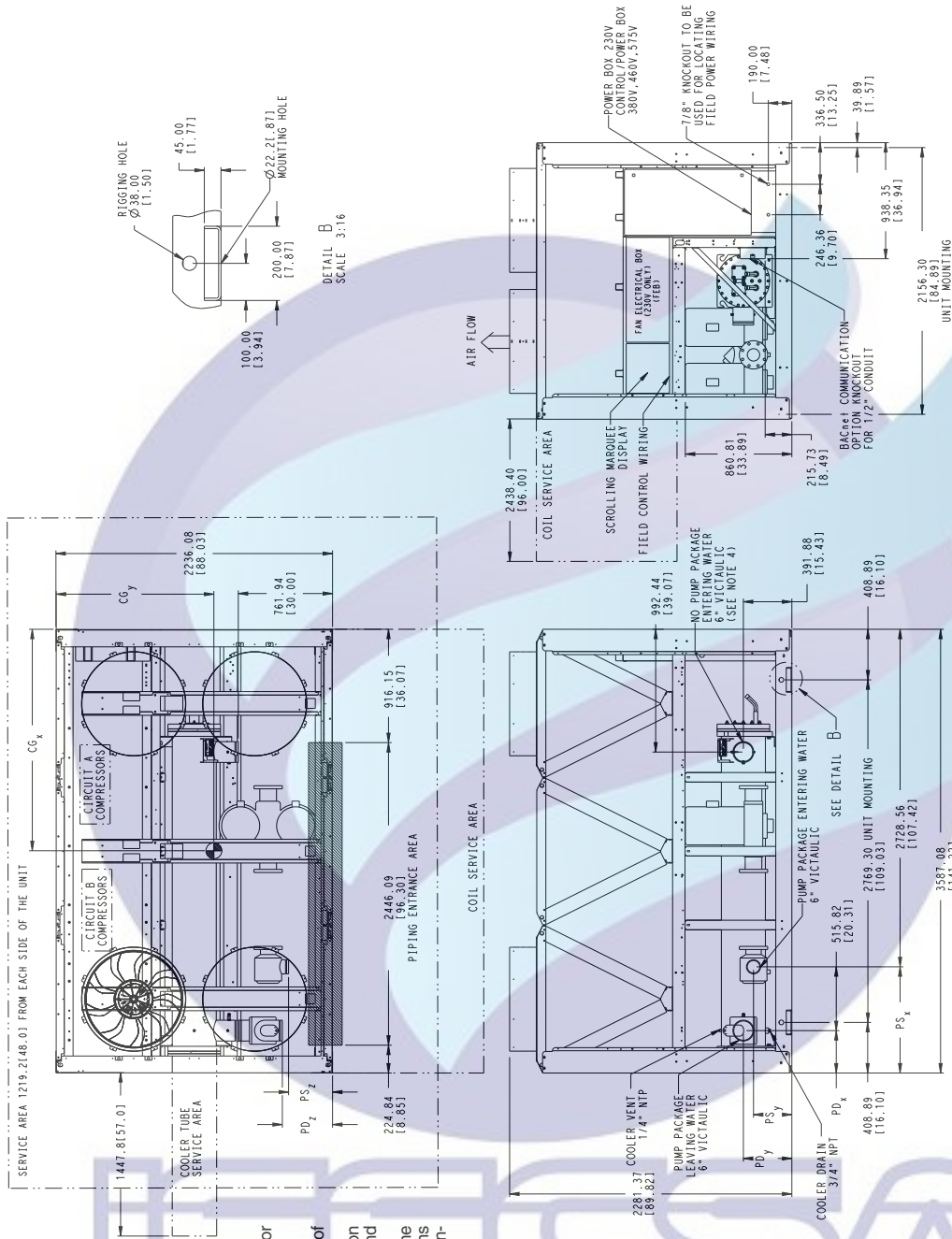

- NOTES:**
- Unit must have clearances as follows:  
 Top — Do not restrict.  
 Sides and End — 6' (1.8 m) from solid surface for airflow.  
 Side — 8' (2.4 m) required for coil service area.
  - All pumps have drains located at the bottom of volute for draining.
  - Temperature relief devices located on suction line, liquid line and filter drier of each circuit and have 1/2" flare connection.
  - Units without a pump package have the same leaving water connection, Y and Z dimensions (entering water), and Pump Discharge X dimensions as units with a pump package.
  - Dimensions are in mm (inches).

**LEGEND**  
 MCHX — Microchannel Condenser Coil

WEIGHT	MAX WEIGHT	MAX WEIGHT	MAX WEIGHT	PUMP SUCTION (FPS)			PUMP DISCHARGE (FPD)			
				X	Y	Z	X	Y	Z	
CU/AL PUMP	1674g	1674g	1674g	±.25	±.25	±.25	±.25	±.25	±.25	
CU/AL PUMP	1674g	1674g	1674g	±.25	±.25	±.25	±.25	±.25	±.25	
30RB-110	2463	2463	2463	171.3	856.0	281.9	60.9	340.4	391.2	233.7
				167.441	133.251	111.1	12.41	113.41	113.41	113.41

### 30RB120,130 AIR-COOLED CHILLER

NOTES:  
 1. Unit must have clearances as follows:  
 Top — Do not restrict.  
 Sides and End — 6' (1.8 m) from solid surface for airflow.  
 Side — 8' (2.4 m) required for coil service area.  
 2. All pumps have drains located at the bottom of volute for draining.  
 3. Temperature relief devices located on suction line, liquid line and filter drier of each circuit and have 1/4" flare connection.  
 4. Units without a pump package have the same leaving water connection, Y and Z dimensions (entering water), and Pump Discharge X dimensions as units with a pump package.  
 5. Dimensions are in mm [inches].

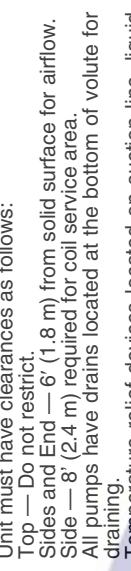

LEGEND  
 MCHX — Microchannel Condenser Coil

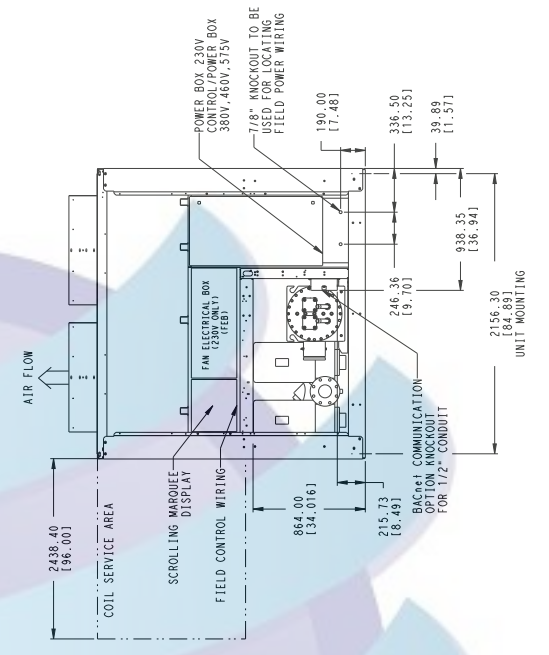
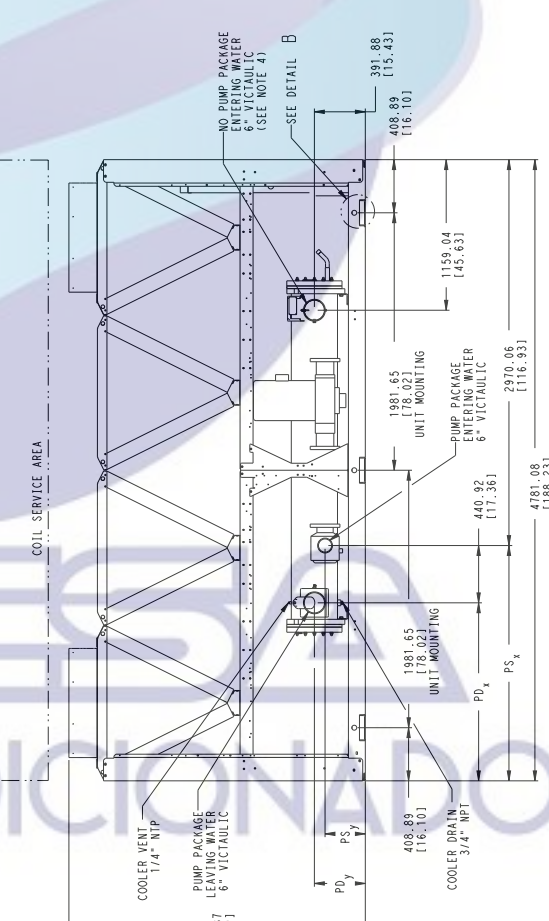
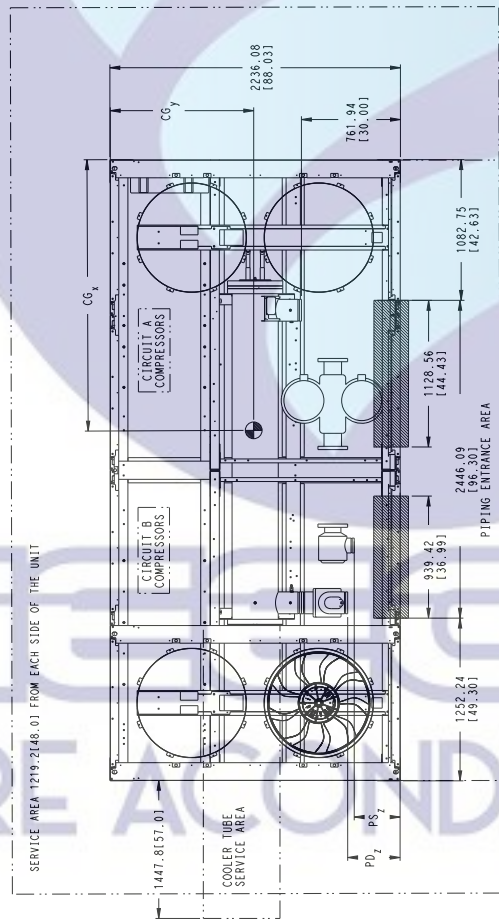

WEIGHT	MAX WEIGHT	WGT	MAX WEIGHT	WGT	MCHX	MCHX PUMP	CENTER OF GRAVITY			PUMP SUCTION (PS)			PUMP DISCHARGE (PD)				
							MM [INCH]	MM [INCH]	MM [INCH]	X	Y	Z	X	Y	Z		
7690	8534	167kg	187kg	1919	1919	8042	CGx	CGy	CGz	X	Y	Z	X	Y	Z		
3468	3907	76kg	86kg	1675	1675	3648	MM [INCH] <td>MM [INCH] <td>MM [INCH] <td>±.25</td> <td>±.25</td> <td>±.25</td> <td>±.25</td> <td>±.25</td> <td>±.25</td> </td></td>	MM [INCH] <td>MM [INCH] <td>±.25</td> <td>±.25</td> <td>±.25</td> <td>±.25</td> <td>±.25</td> <td>±.25</td> </td>	MM [INCH] <td>±.25</td> <td>±.25</td> <td>±.25</td> <td>±.25</td> <td>±.25</td> <td>±.25</td>	±.25	±.25	±.25	±.25	±.25	±.25		
30RB-120	8613	191kg	191kg	1919	1919	8042	2346	993	1808.5	281.9	60.9	1366.5	391.2	233.7	153.81	175.41	19.2
30RB-130	8613	191kg	191kg	1919	1919	8042	92.361	135.991	171.21	111.11	12.41	153.81	175.41	19.2			



### 30RB160, 170 AIR-COOLED CHILLER

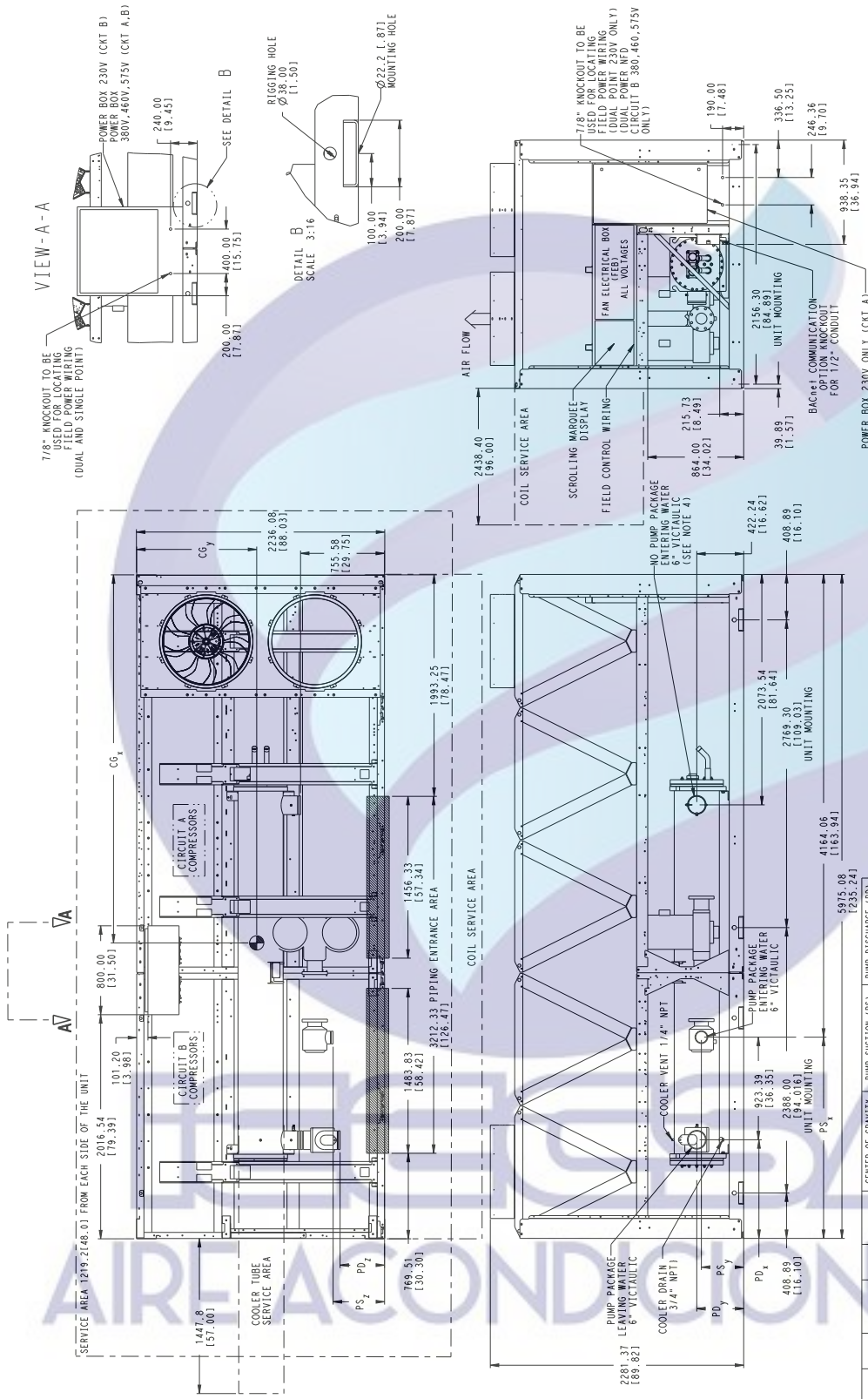

**LEGEND**  
 MCHX — Microchannel Condenser Coil

	WEIGHT 16/15g	MAX WEIGHT CU/CH 10/15g	WEIGHT CU/CH 10/15g	PUMP 16/15g	MCHX 16/15g	CENTER OF GRAVITY			PUMP SUCTION (PS)			PUMP DISCHARGE (PD)		
						CG <sub>x</sub> MM [INCH]	CG <sub>y</sub> MM [INCH]	CG <sub>z</sub> MM [INCH]	X	Y	Z	X	Y	Z
30RB-160	10266	11511	11472	12717	9445	10720	13086	984	808.48	381	297.7	883.92	421.64	231.14
16886	3526	3619	308	4859	4650	1760.83	1931.91	1036.21	175.01	524.63	116.89	181	181	
30RB-170	14819	5385	5387	5932	4443	3009	1122.91	1300.51	107.21	115.01	111.71	534.26	116.64	19.11

- NOTES:**
- Unit must have clearances as follows:  
 Top — Do not restrict.  
 Sides and End — 6' (1.8 m) from solid surface for airflow.  
 Side — 8' (2.4 m) required for coil service area.
  - All pumps have drains located at the bottom of volute for draining.
  - Temperature relief devices located on suction line, liquid line and filter drier of each circuit and have 1/4" flare connection.
  - Units without a pump package have the same leaving water connection, Y and Z dimensions (entering water), and Pump Discharge X dimensions as units with a pump package.
  - Dimensions are in mm [inches].

## 30RB190 AIR-COOLED CHILLER

**NOTES:**

- Unit must have clearances as follows:  
 Top — Do not restrict.  
 Sides and End — 6' (1.8 m) from solid surface.  
 Side — 8' (2.4 m) required for coil service area.  
 All pumps have drains located at the bottom of volute for draining.
- Temperature relief devices located on suction line, liquid line and filter drier of each circuit and have 1/4" flare connection.
- Dimensions are in mm [inches].

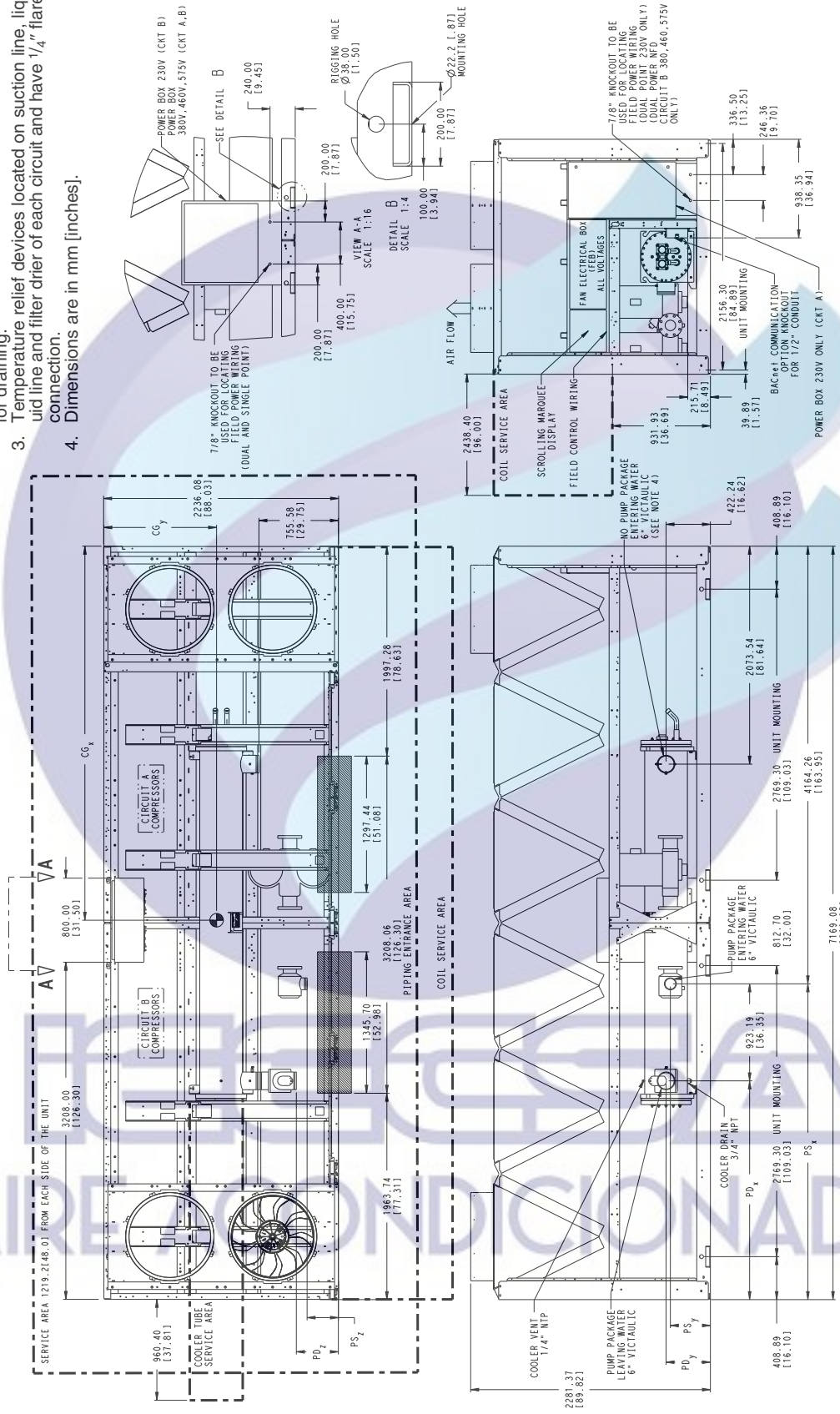

WEIGHT	MAX WEIGHT	WEIGHT	MAX WEIGHT	PUMP SUCTION (PS)			PUMP DISCHARGE (PD)			
				X	Y	Z	X	Y	Z	
12013	13258	13460	14705	974	3002	381	297.2	2804.3	421.6	231.1
3461	6014	6118	14705	140.87	118.2	115.0	117.7	181.9	116.6	15.1

LEGEND  
**MCHX** — Microchannel Condenser Coil



### 30RB210,225 AIR-COOLED CHILLER

- NOTES:**
- Unit must have clearances as follows:  
 Top — Do not restrict.  
 Sides and End — 6' (1.8 m) from solid surface.  
 Side — 8' (2.4 m) required for coil service area.
  - Temperature relief devices located on suction line, liquid line and filter drier of each circuit and have 1/4" flare connection.
  - Dimensions are in mm [inches].

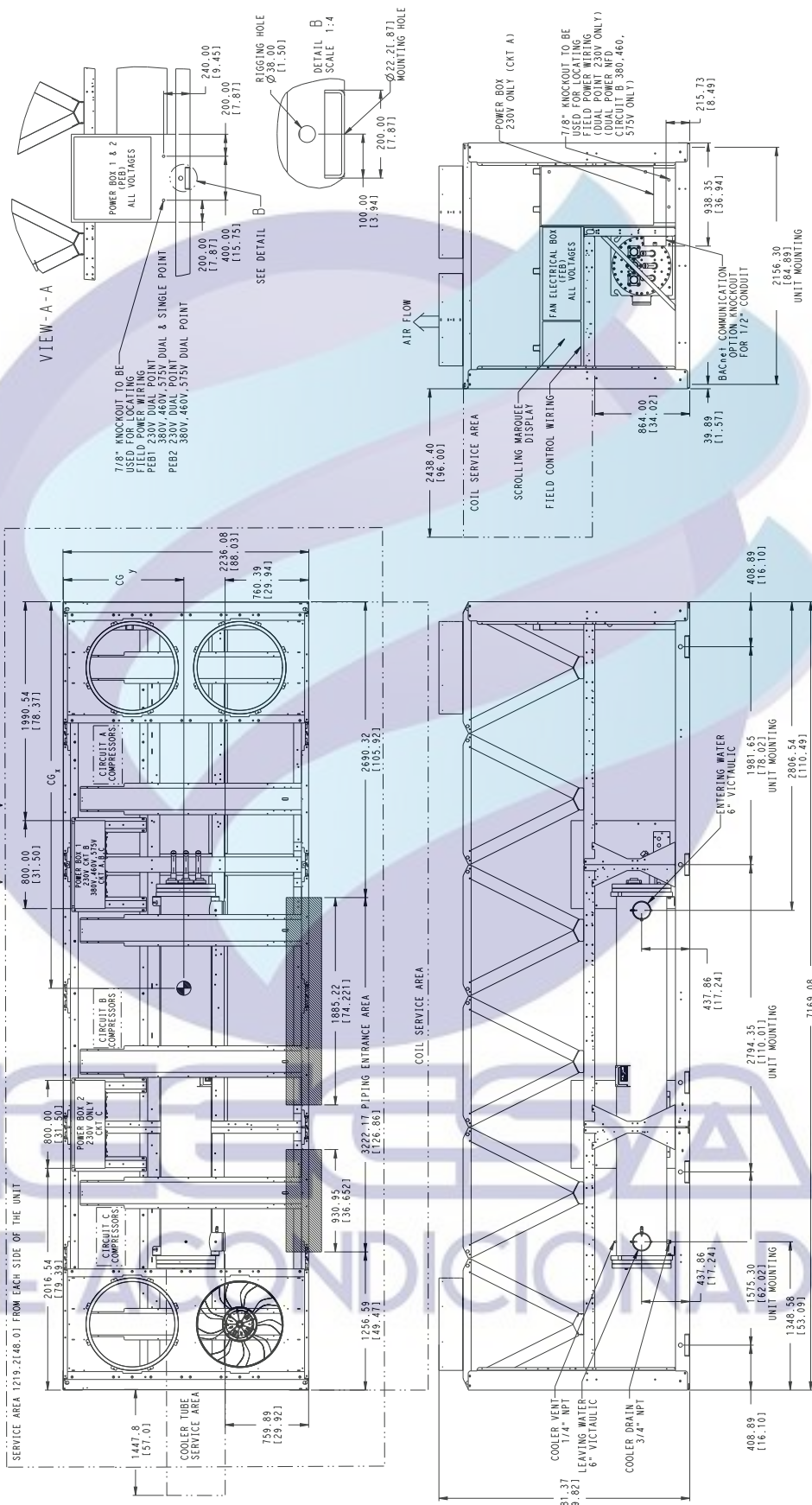

WEIGHT	WEIGHT	CENTER OF GRAVITY			
		CG <sub>X</sub>	CG <sub>Y</sub>		
CU/L	CU/CU	MM [INCH]	MM [INCH]		
30RB-210	13134	15181	3528	592	917
	6901	5793	1386.901	36.10	
30RB-225	14067	15514	3508	906	
	6934	7025	3937	147.26	35.87

LEGEND  
MCHX — Microchannel Condenser Coil

## 30RB250 AIR-COOLED CHILLER

NOTES:  
 1. Unit must have clearances as follows:  
 Top — Do not restrict.  
 Sides and End — 6' (1.8 m) from solid surface.  
 Side — 8' (2.4 m) required for coil service area.

- Temperature relief devices located on suction line, liquid line and filter drier of each circuit and have 1/4" flare connection.
- Dimensions are in mm [inches].

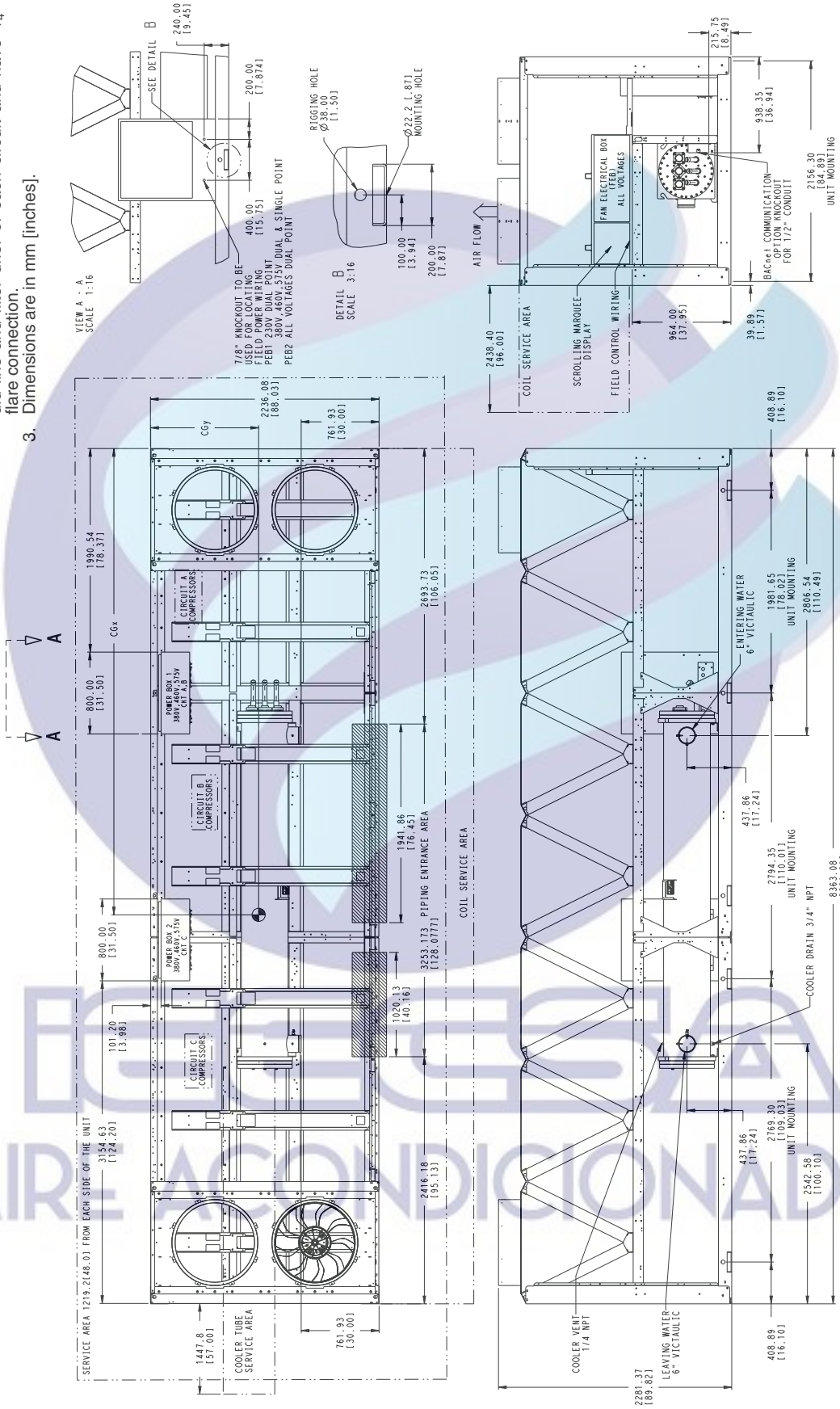

WEIGHT	WEIGHT	CENTER OF GRAVITY		
CU/AL	MC/CH	CG*	CGx	CGy
lb/ft	lb/ft	MM [INCH]	MM [INCH]	MM [INCH]
15468	17157	14349	4022	910
3088-250	7031	7789	6509	1190-355

LEGEND  
 MCHX — Microchannel Condenser Coil

### 30RB275 AIR-COOLED CHILLER

**NOTES:**

- Unit must have clearances as follows:  
 Top — Do not restrict.  
 Sides and End — 6' (1.8 m) from solid surface.  
 Side — 8' (2.4 m) required for coil service area.
- Temperature relief devices located on suction line, liquid line and filter drier of each circuit and have 1/4" flare connection.
- Dimensions are in mm [inches].

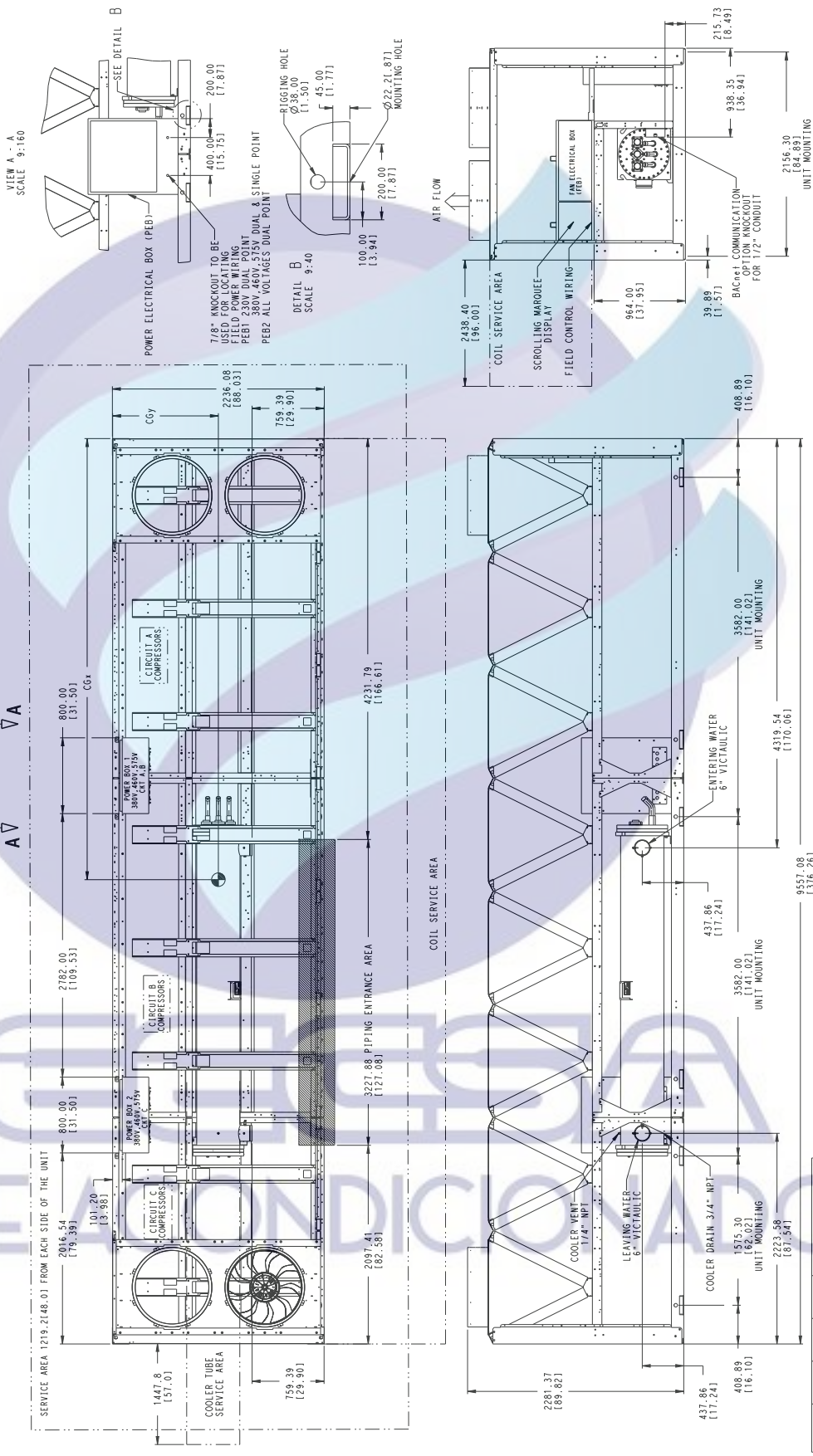

	WEIGHT	CENTER OF GRAVITY	CGY		
			CU/AL	CU/CU	CGY
	lb/kg	MM [INCH]	MM [INCH]	MM [INCH]	
30RB-275	16915 7689	18845 8556	15647 615.7	4857 191.22	914 35.98

**LEGEND**  
**MCHX** — Microchannel Condenser Coil

## 30RB300 AIR-COOLED CHILLER

- NOTES:**
- Unit must have clearances as follows:  
 Top — Do not restrict.  
 Sides and End — 6' (1.8 m) from solid surface.  
 Side — 8' (2.4 m) required for coil service area.
  - Temperature relief devices located on suction line, liquid line and filter drier of each circuit and have 1/4" flare connection.
  - Dimensions are in mm [inches].

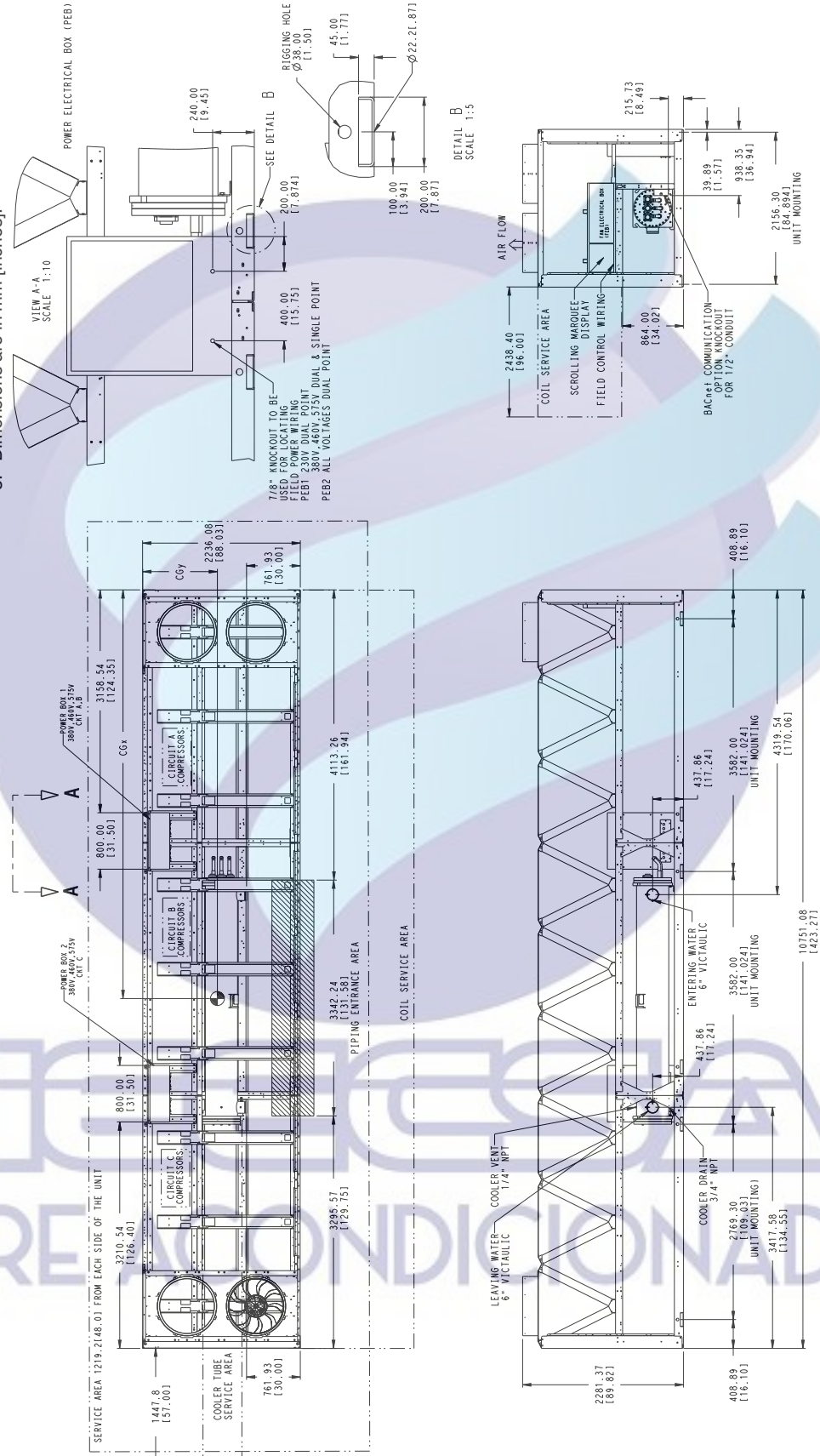

	WEIGHT CU/LAL LB/KG	WEIGHT MCHX LB/KG	CENTER OF GRAVITY	
			CGX MM [INCH]	CGY MM [INCH]
30RB-300	18306 8321	20477 9308	5317 [209.33]	916 [36.06]

**LEGEND**  
**MCHX** — Microchannel Condenser Coil

# Selection procedure

Carrier's NACO (North American Commercial Operations) Packaged Chiller Builder Program provides quick, easy selection of Carrier's air-cooled liquid chillers. The program considers specific temperature, fluid and flow requirements among other factors such as fouling and altitude corrections. Before selecting a chiller, consider the following points:

## Leaving water (fluid) temperature (LWT)

- If the LWT is less than 40°F (4.4°C), loop freeze protection to a minimum of 30°F (16.6°C) below the LWT set point is required.
- If the LWT is to be between 15°F and 30°F (-9.4°C and -1.1°C) and the unit size is 30RB060-100, then both suction line insulation and low ambient head pressure control (or 30RB chiller with Greenspeed® intelligence) must be included. For unit sizes 30RB110-390, operation below 30°F (-1.1°C) is not available.
- If the LWT requirement is greater than 60°F (16°C), a mixing loop is required.

## Entering water temperature (EWT)

- If the EWT requirement is greater than 70°F (21.1°C), a mixing loop is required. The EWT cannot exceed 70°F (21.1°C) for extended operation. Pulldown can be accomplished from 95°F (35°C).

## Cooler flow rate or cooler delta-T

- The cooler delta-T must fall between 3 and 20°F (1.7 and 11°C) while still meeting both the fluid min/max temperature requirements as well as the fluid min/max flow requirements.
- For larger or smaller delta-T applications, a mixing loop is required.
- If the cooler flow is variable, then the rate of change of flow should not exceed 10% per minute. A loop volume of greater than 3 gallons per ton (3.25 L per kW) is recommended.

## Cooler pressure drop

- A high cooler pressure drop can be expected when the cooler delta-T is low. A mixing loop can help to alleviate this situation.

## Water quality, fouling factor

- Poor water quality can increase the cooler fouling.
- Higher than standard fouling factors lead to lower capacity and higher input kW from a given chiller size compared to running the same application with better quality water (and lower fouling factors).

## Operation below 32°F (0°C)

- Low ambient head pressure control (or 30RB chiller with Greenspeed intelligence) is required.
- Wind baffles are required.
- Consider higher loop volumes, 6 to 10 gallons per nominal ton (6.5 to 10.75 L per kW).
- Loop freeze protection with glycol is strongly recommended to a minimum of 15°F (8°C) below lowest anticipated ambient temperature.
- Chilled water pump control is strongly recommended; otherwise override capability is required.
- Consider the remote cooler option. Do not bury refrigerant piping.

## Chiller idle below 32°F (0°C)

- Loop freeze protection with glycol is strongly recommended to a minimum of 15°F (8°C) below lowest anticipated ambient temperature.
- Chilled water pump control is strongly recommended; otherwise override capability is required.
- Drain the cooler — This will require a small amount of glycol for residual water. Cooler heaters (if provided) will need to be disconnected.
- Consider the remote cooler option. Never bury refrigerant lines.

## Ambient temperature

- Highest allowable ambient air temperature is 125°F (52°C) for all unit sizes.
- Lowest allowable ambient temperature for the standard unit to start and operate is 32°F (0°C). With the inclusion of wind baffles (field fabricated and installed) and low ambient head pressure control (low ambient control is not required on units with Greenspeed intelligence), the unit is capable to start as low as -13°F (-25°C) and to operate as low as -20°F (-29°C) ambient temperature.

## Cooling capacity requirements

- Do not oversize the chillers by more than 15% at design conditions.
- If close capacity control is required below the standard minimum step of unloading, the minimum load control option should be employed.

## Coil corrosion requirements

- Coastal application
- Industrial application
- Coastal/industrial application
- Urban application
- Farming

NOTE: See NACO Packaged Chiller Builder and appropriate selection guides for more information.

## Chilled water pump external head requirement

## Capacity control

- Temperature reset
- Return water reset
- Outside air temperature reset
- Space temperature reset
- 4 to 20 mA temperature reset (requires an energy management module)

## Demand limit

- 2-step (requires an energy management module)
- 4 to 20 mA (requires an energy management module)
- CCN loadshed

To select a chiller, use the Packaged Chiller Builder Program.

## AquaSnap® pump selection

Several pump sizes are available for each AquaSnap chiller size to provide flexibility in matching water system requirements. A dual pump option is also available for primary/standby operation. The Carrier Packaged Chiller Builder Program must be used for pump selection.

Proper water system design is critical; cooling loads, water pressure drops and proper water line sizing must be accounted for in order to ensure proper system operation. Incorrect or incomplete analysis/design of the water loop could lead to low water flow, loss of water temperature control, and excessive cycling of chiller compressors.

## PUMP IMPELLER SIZES

UNIT 30RB	PUMP Hp	SINGLE PUMP				DUAL PUMP			
		Option Code*	Rpm	Impeller Dia. (in.)	Pump Curve	Option Code*	Rpm	Impeller Dia. (in.)	Pump Curve
060 070	3	0	1750	6.5	I	6	1750	6.5	V
	5	1	1750	7.3	I	7	1750	7.3	V
	7.5	2	1750	8.15	I	8	1750	8.15	V
						9	3450	5.25	VI
10	3	3450	5.4	II	B	3450	5.9	VI	
080 090 100 110 120 130	5	1	1750	7.3	I	7	1750	7.3	V
	7.5	2	1750	8.15	I	8	1750	8.15	V
	10	3	3450	5.4	II	B	3450	5.4	VIIIA
	15	4	3450	6.1	II	C	3450	6.0	VIIIC
150 160 170 190	5	1	1750	6.5	IIIA	—	—	—	—
	7.5	2	1750	7.4	IIIB	9	3450	5.0	VIIIB
	10	3	3450	4.6	IVA	B	3450	4.6	VIIIA
	15	4	3450	5.2	IVB	C	3450	5.2	VIIIB

\*Option Code refers to the Hydronics Option (position 11) in the model number. See the 30RB nomenclature on page 5 for option identification.

NOTE: Pump Selections are chiller-size dependent. For example, dual pump "C" on a 30RB170 chiller is not the same as dual pump "C" on a 30RB130 chiller. The pump option is not available on units with high SCCR option. The 30RB chillers with Greenspeed® intelligence are not available for size 060 and 070.

## COOLER PRESSURE DROP CURVES

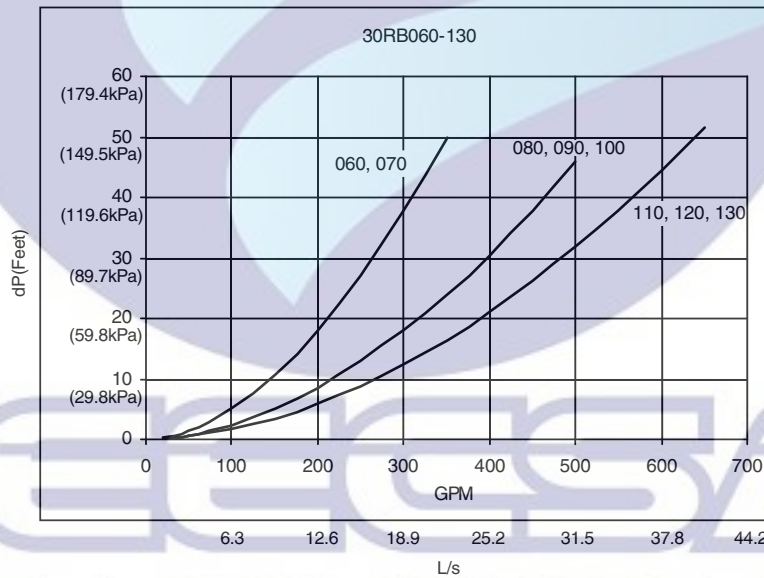

### COOLER PRESSURE DROP CURVES (cont)

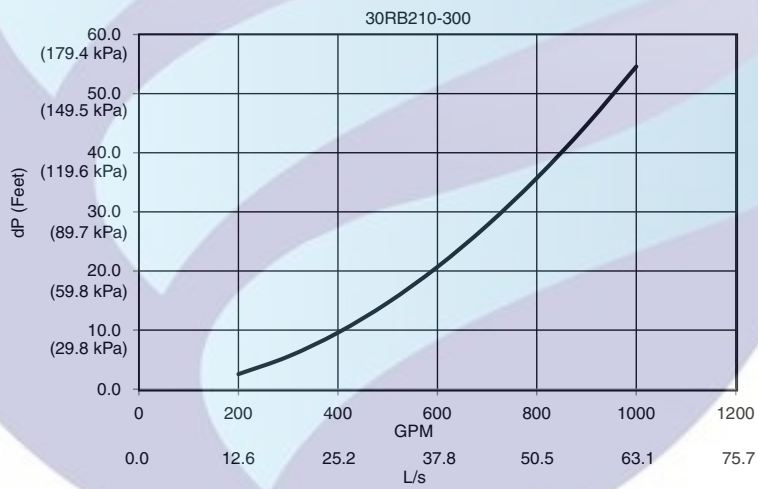
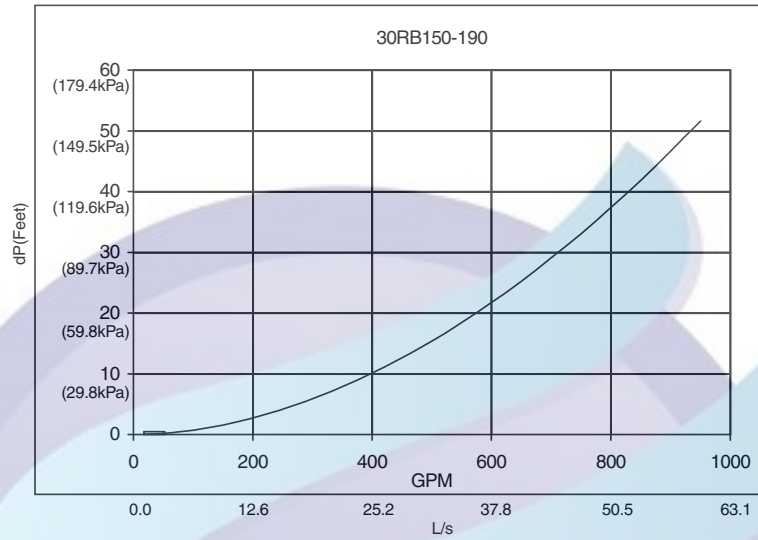

**IEEGCSA**  
**AIRE ACONDICIONADO**

**PUMP CURVE I FOR HYDRONIC PACKAGE SINGLE PUMP (Fresh Water)**

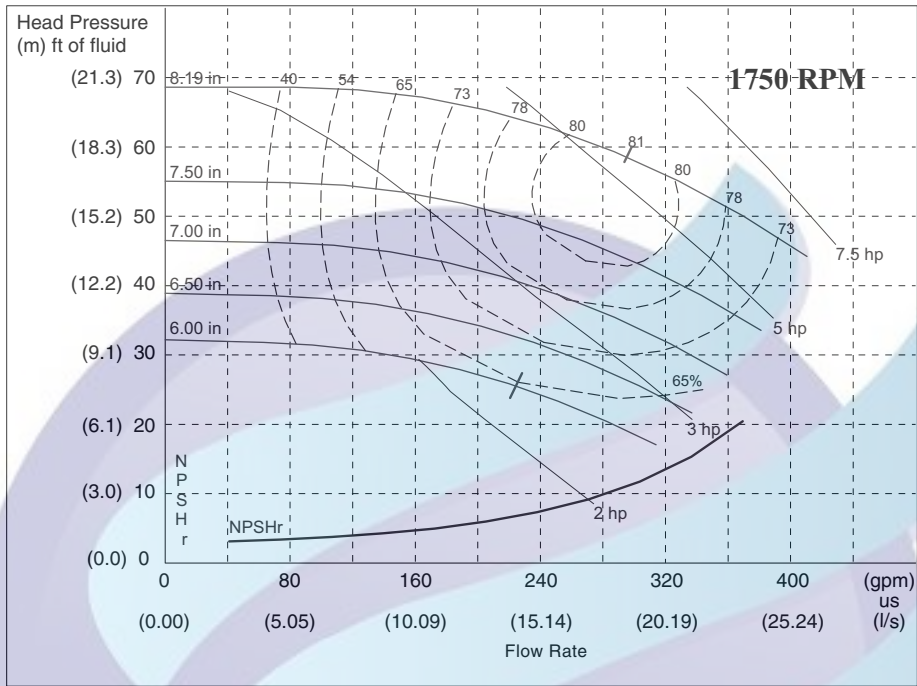

**LEGEND**  
**NPSHr** — Net Positive Suction Head (Pressure) Required

**NOTE:** Refer to the 30RB nomenclature on page 5 for option identification. Refer to the Pump Impeller Sizes table on page 30 for more information.

**PUMP CURVE II FOR HYDRONIC PACKAGE SINGLE PUMP (Fresh Water)**

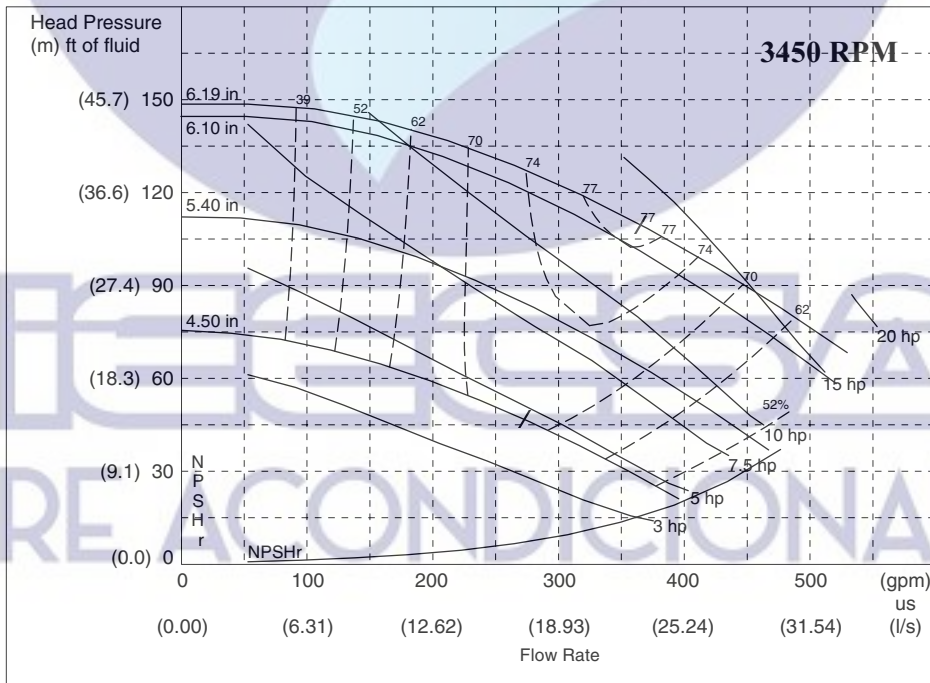

**LEGEND**  
**NPSHr** — Net Positive Suction Head (Pressure) Required

**NOTE:** Refer to the 30RB nomenclature on page 5 for option identification. Refer to the Pump Impeller Sizes table on page 30 for more information.



**PUMP CURVE IIIA FOR HYDRONIC PACKAGE SINGLE PUMP (Fresh Water)**

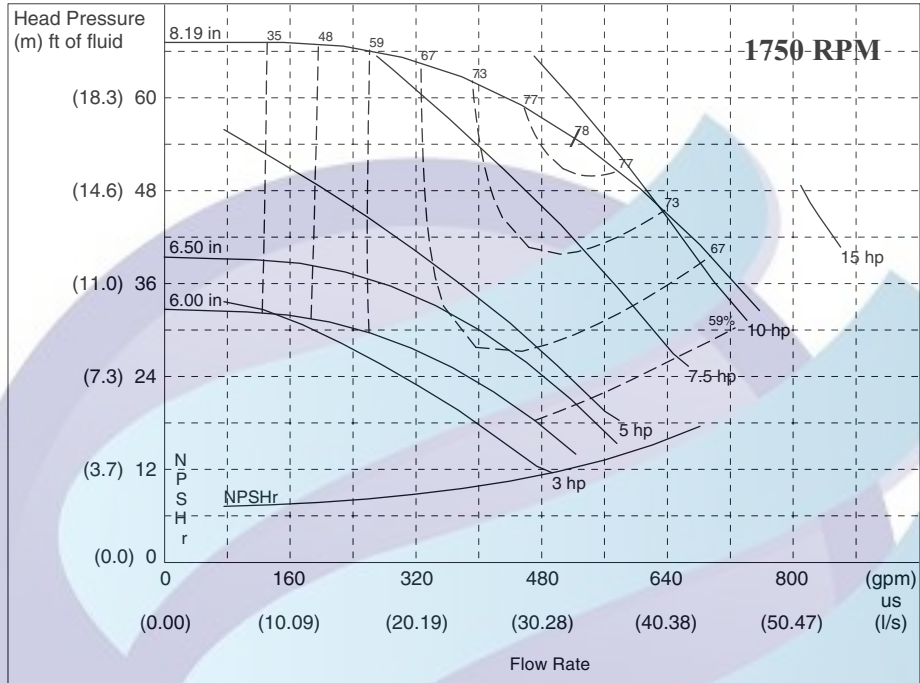

**LEGEND**  
**NPSHr** — Net Positive Suction Head (Pressure) Required

**NOTE:** Refer to the 30RB nomenclature on page 5 for option identification. Refer to the Pump Impeller Sizes table on page 30 for more information.

**PUMP CURVE IIIB FOR HYDRONIC PACKAGE SINGLE PUMP (Fresh Water)**

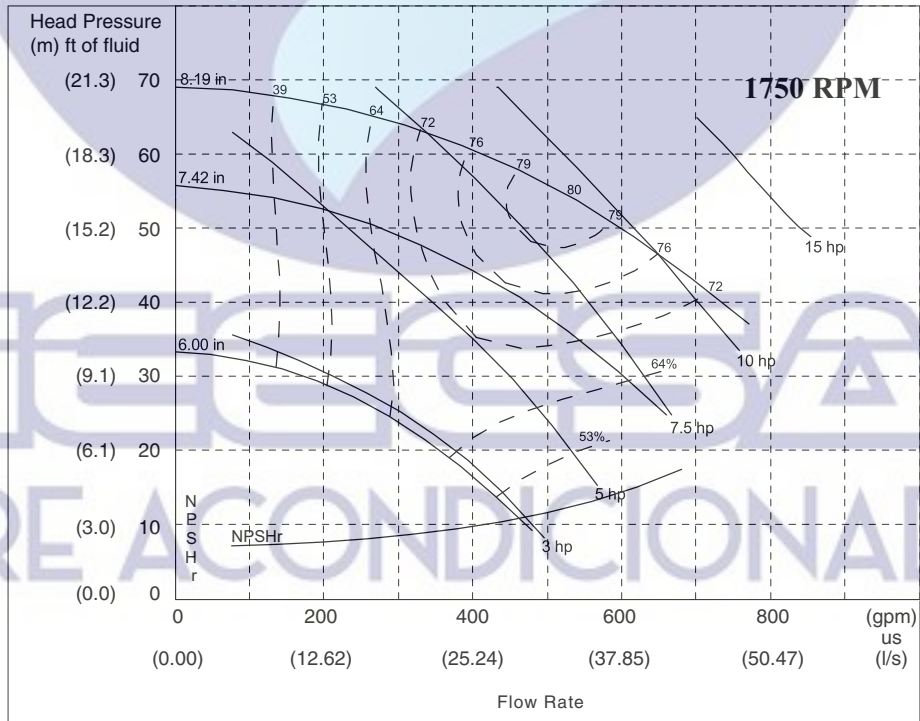

**LEGEND**  
**NPSHr** — Net Positive Suction Head (Pressure) Required

**NOTE:** Refer to the 30RB nomenclature on page 5 for option identification. Refer to the Pump Impeller Sizes table on page 30 for more information.

## PUMP CURVE IVA FOR HYDRONIC PACKAGE SINGLE PUMP (Fresh Water)

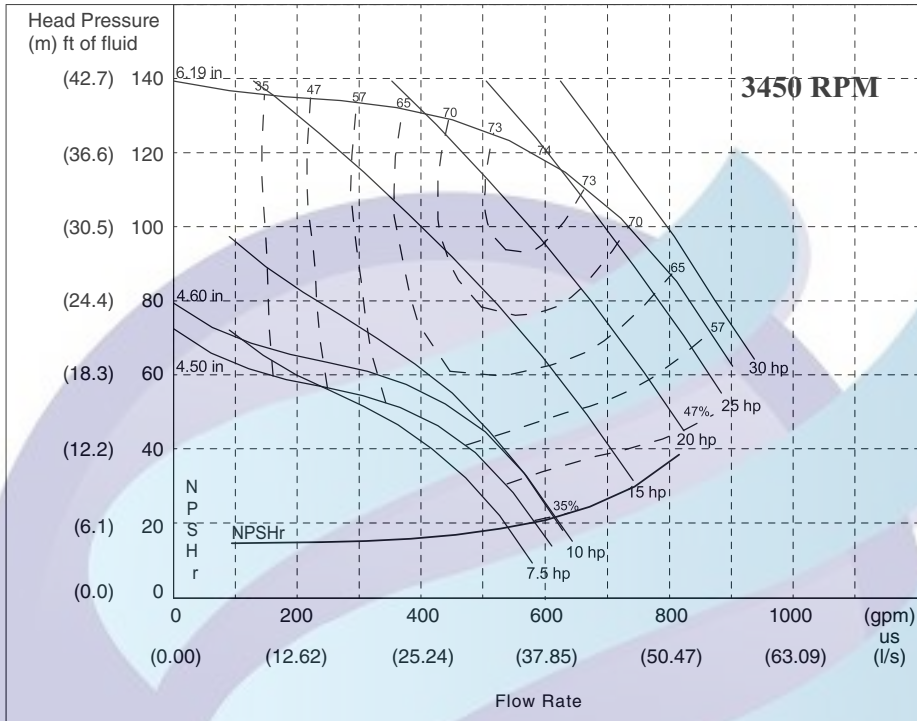

**LEGEND**  
**NPSHr** — Net Positive Suction Head (Pressure) Required

**NOTE:** Refer to the 30RB nomenclature on page 5 for option identification. Refer to the Pump Impeller Sizes table on page 30 for more information.

## PUMP CURVE IVB FOR HYDRONIC PACKAGE SINGLE PUMP (Fresh Water)

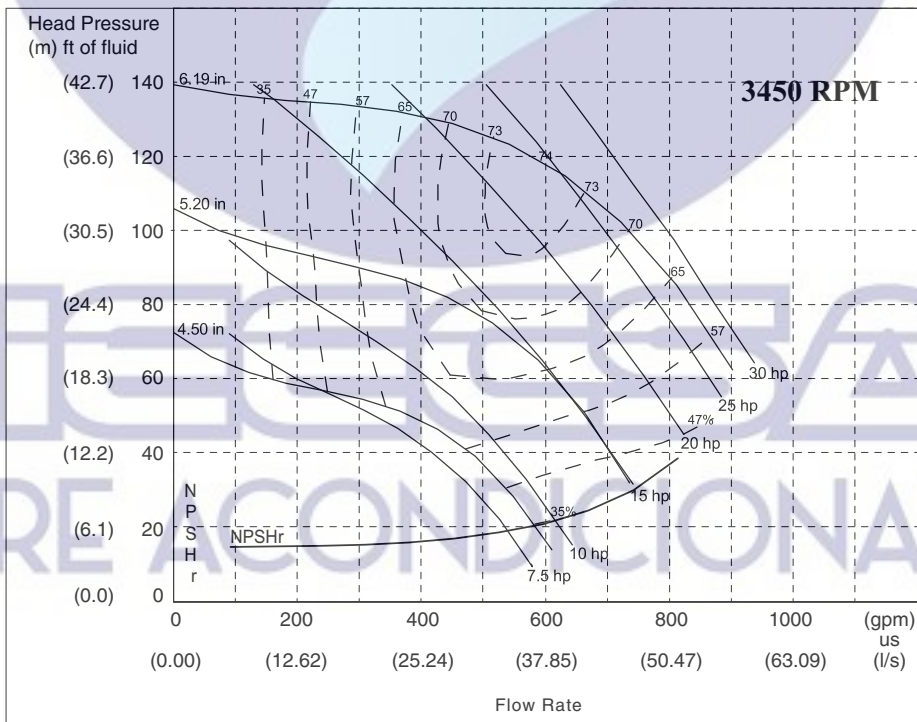

**LEGEND**  
**NPSHr** — Net Positive Suction Head (Pressure) Required

**NOTE:** Refer to the 30RB nomenclature on page 5 for option identification. Refer to the Pump Impeller Sizes table on page 30 for more information.

### PUMP CURVE V FOR HYDRONIC PACKAGE DUAL PUMP (Fresh Water)

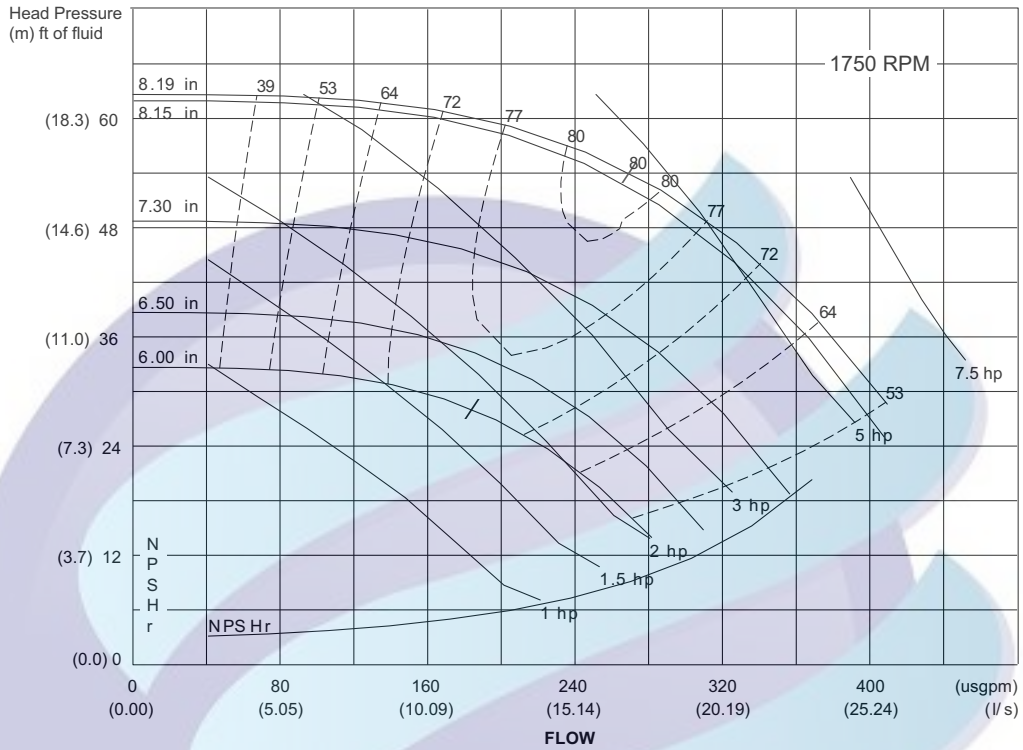

LEGEND  
NPSHr — Net Positive Suction Head (Pressure) Required

NOTE: Refer to the 30RB nomenclature on page 5 for option identification. Refer to the Pump Impeller Sizes table on page 30 for more information.

### PUMP CURVE VI FOR HYDRONIC PACKAGE DUAL PUMP (Fresh Water)

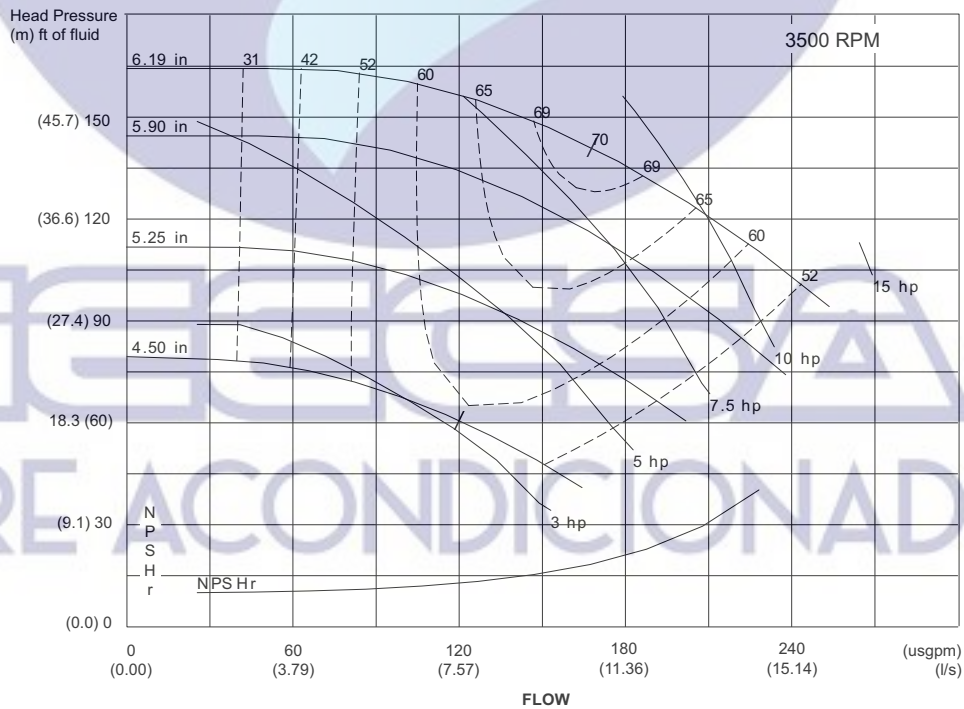

LEGEND  
NPSHr — Net Positive Suction Head (Pressure) Required

NOTE: Refer to the 30RB nomenclature on page 5 for option identification. Refer to the Pump Impeller Sizes table on page 30 for more information.

**PUMP CURVE VIIA FOR HYDRONIC PACKAGE DUAL PUMP (Fresh Water)**

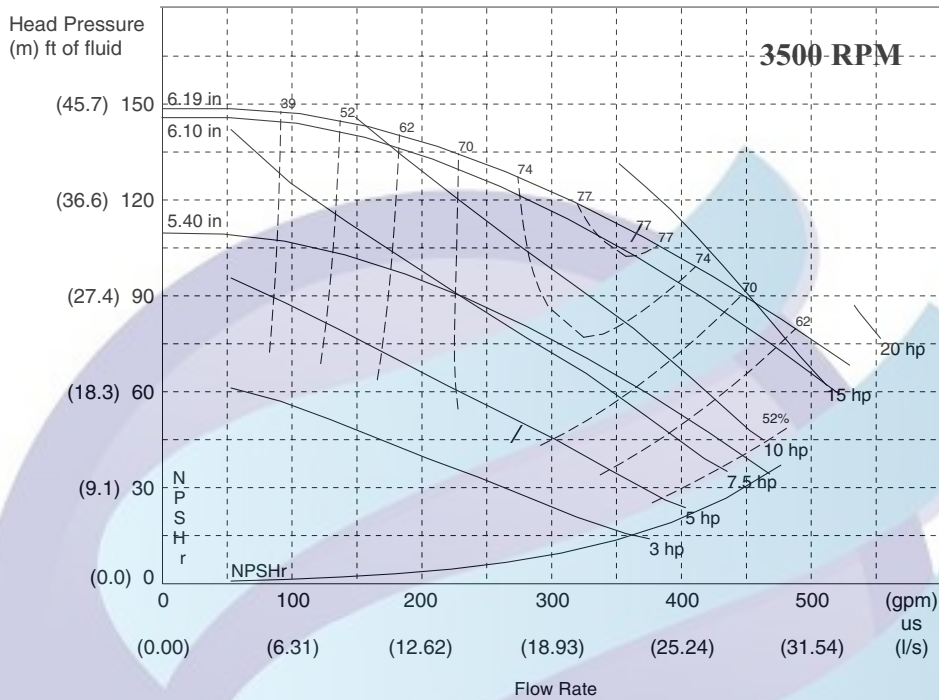

**LEGEND**  
**NPSH<sub>r</sub>** — Net Positive Suction Head (Pressure) Required

**NOTE:** Refer to the 30RB nomenclature on page 5 for option identification. Refer to the Pump Impeller Sizes table on page 30 for more information.

**PUMP CURVE VIIIB FOR HYDRONIC PACKAGE DUAL PUMP (Fresh Water)**

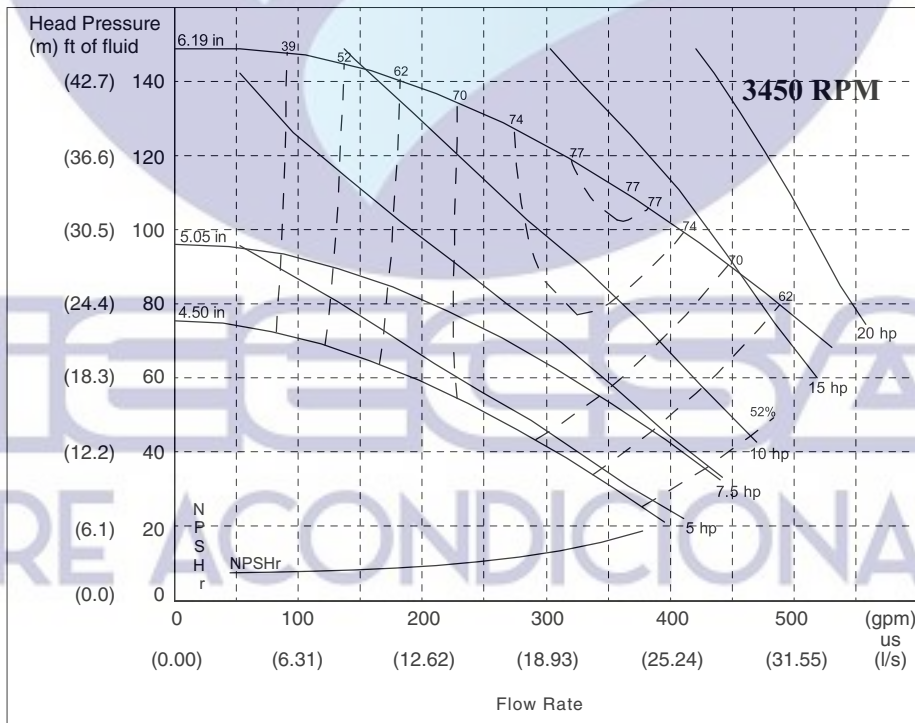

**LEGEND**  
**NPSH<sub>r</sub>** — Net Positive Suction Head (Pressure) Required

**NOTE:** Refer to the 30RB nomenclature on page 5 for option identification. Refer to the Pump Impeller Sizes table on page 30 for more information.

**PUMP CURVE VIIC FOR HYDRONIC PACKAGE DUAL PUMP (Fresh Water)**

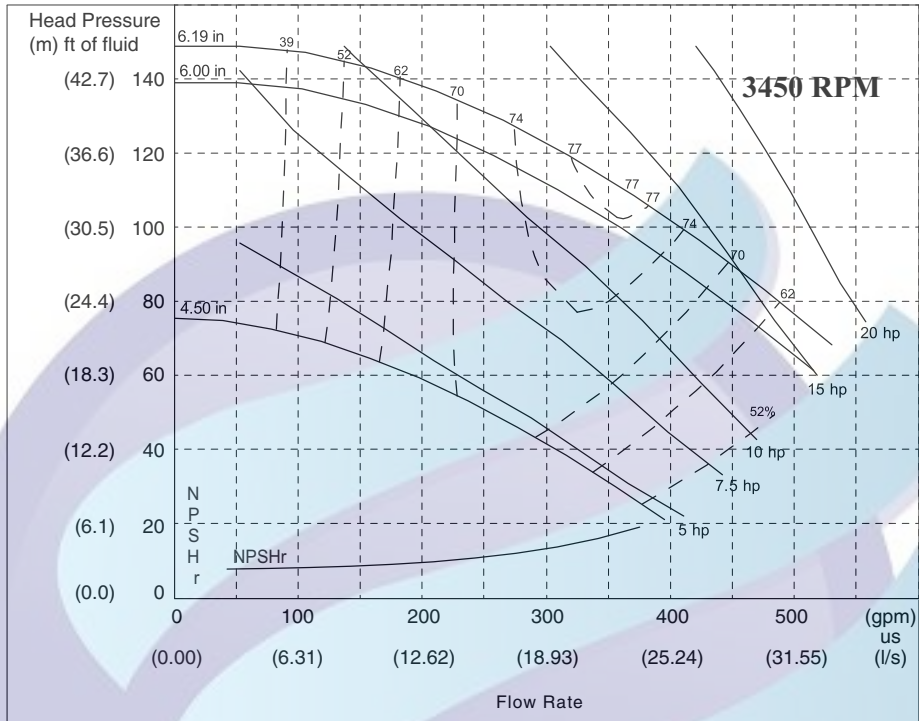

**LEGEND**  
**NPSHr** — Net Positive Suction Head (Pressure) Required

**NOTE:** Refer to the 30RB nomenclature on page 5 for option identification. Refer to the Pump Impeller Sizes table on page 30 for more information.

**PUMP CURVE VIIIA FOR HYDRONIC PACKAGE DUAL PUMP (Fresh Water)**

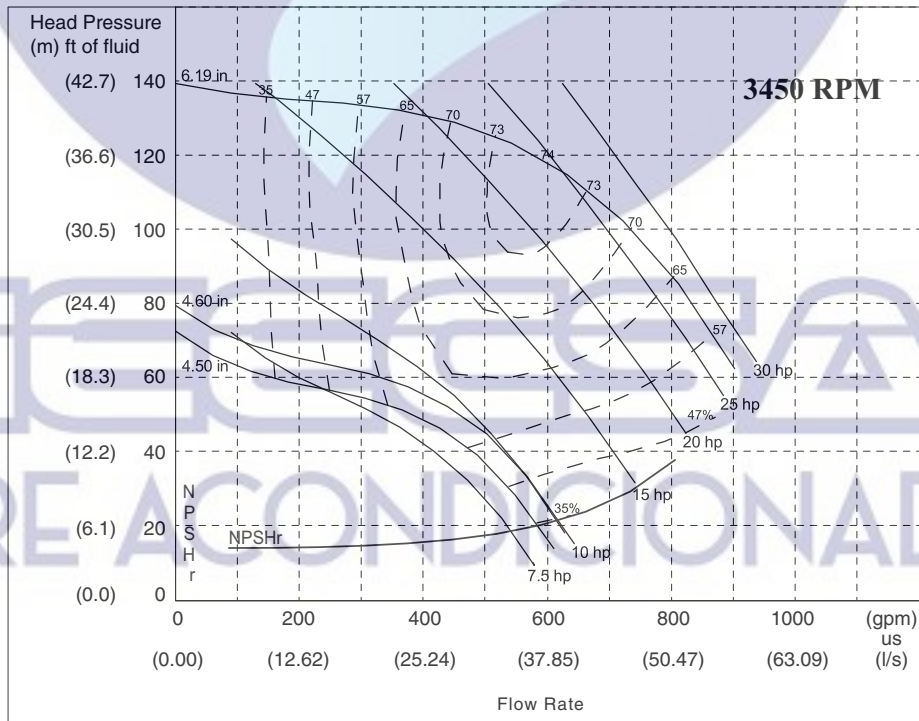

**LEGEND**  
**NPSHr** — Net Positive Suction Head (Pressure) Required

**NOTE:** Refer to the 30RB nomenclature on page 5 for option identification. Refer to the Pump Impeller Sizes table on page 42 for more information.

**PUMP CURVE VIII B FOR HYDRONIC PACKAGE DUAL PUMP (Fresh Water)**

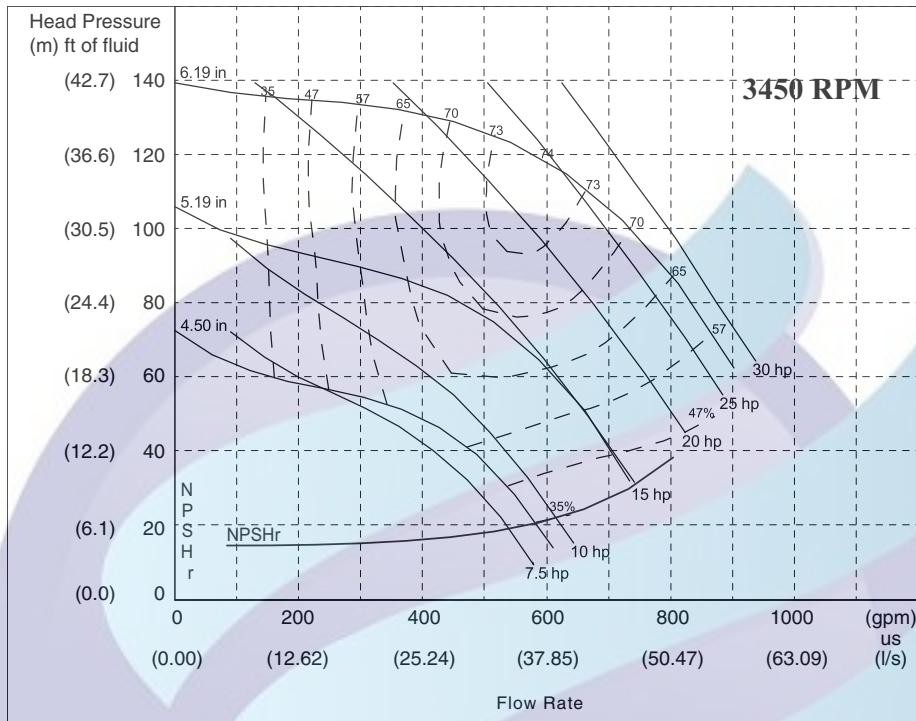

**LEGEND**  
**NPSHr** — Net Positive Suction Head (Pressure) Required

**NOTE:** Refer to the 30RB nomenclature on page 5 for option identification. Refer to the Pump Impeller Sizes table on page 30 for more information.



### 30RB060, 070 — SINGLE PUMP ENVELOPE CURVES

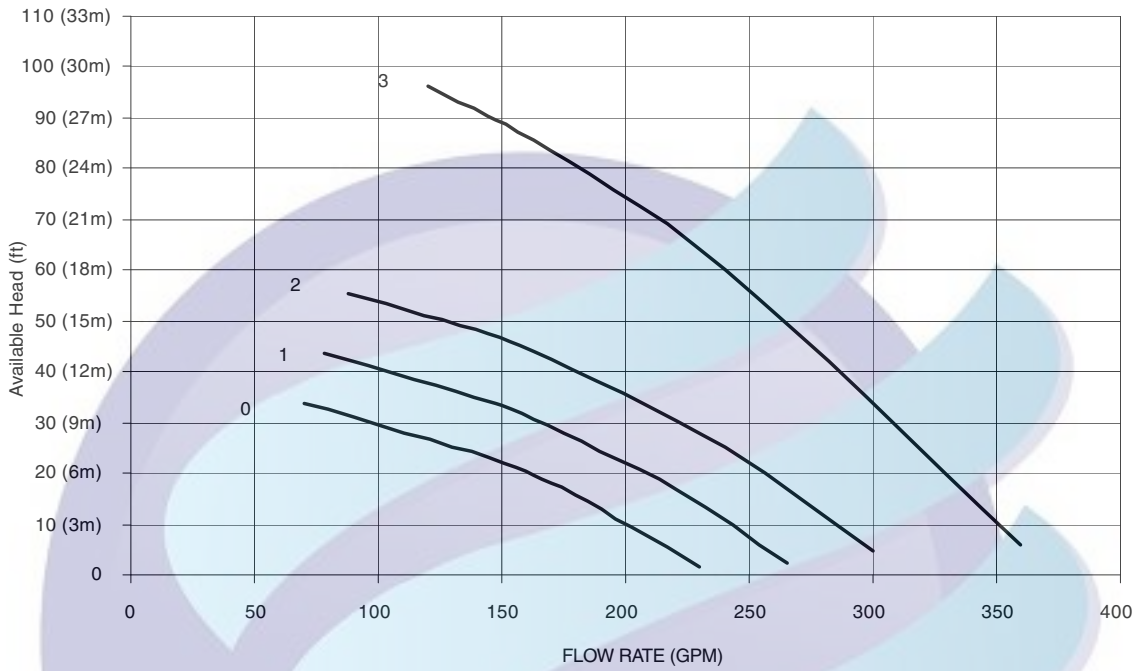

### 30RB080, 090, 100 — SINGLE PUMP ENVELOPE CURVES

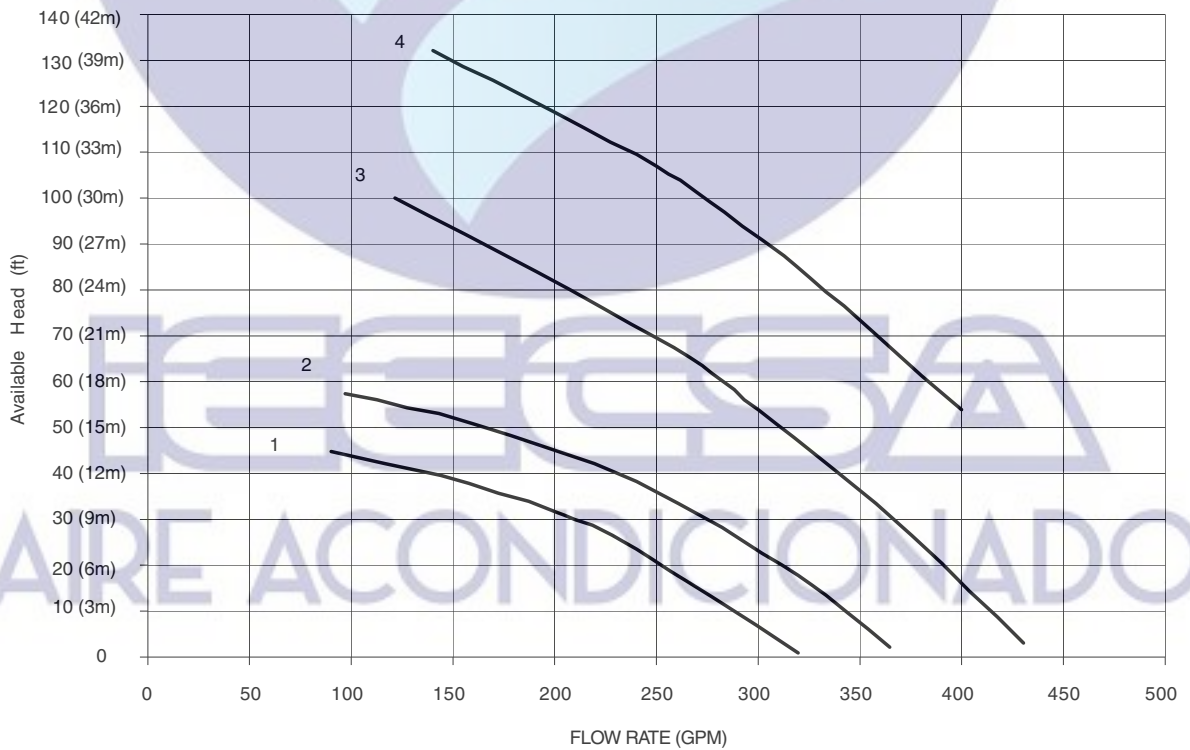

NOTE: Refer to the 30RB nomenclature on page 5 for pump envelope curve option identification.

## 30RB110, 120, 130 — SINGLE PUMP ENVELOPE CURVES

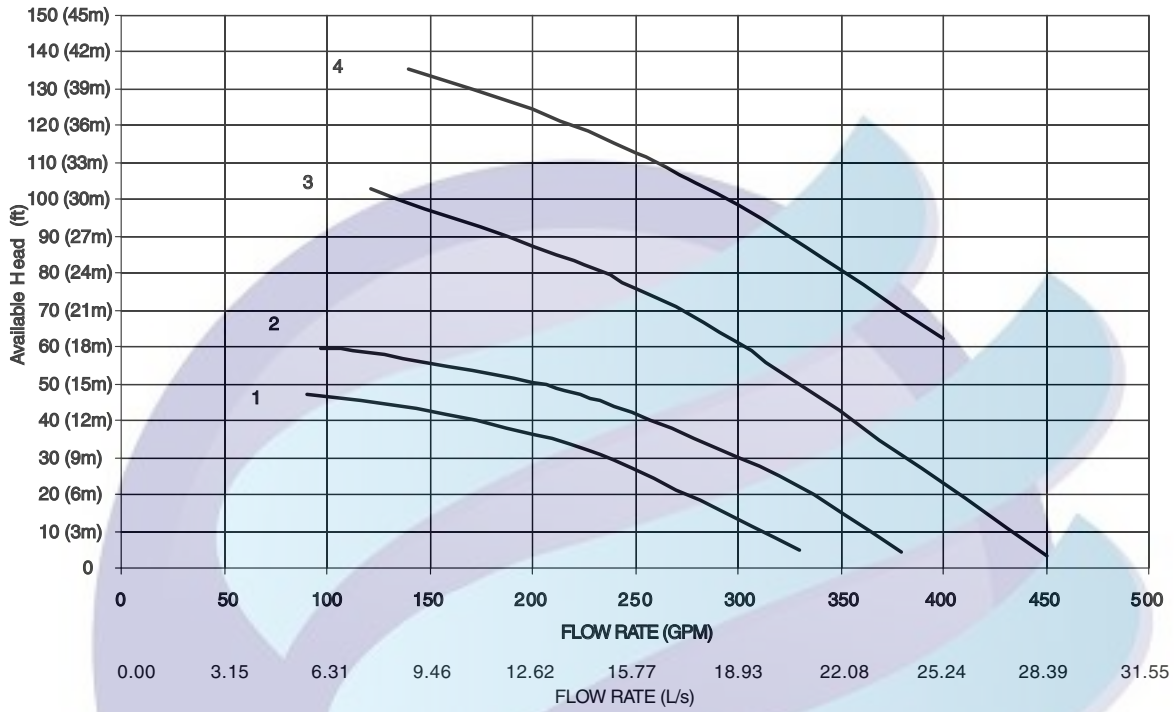

## 30RB150, 160, 170, 190 — SINGLE PUMP ENVELOPE CURVES

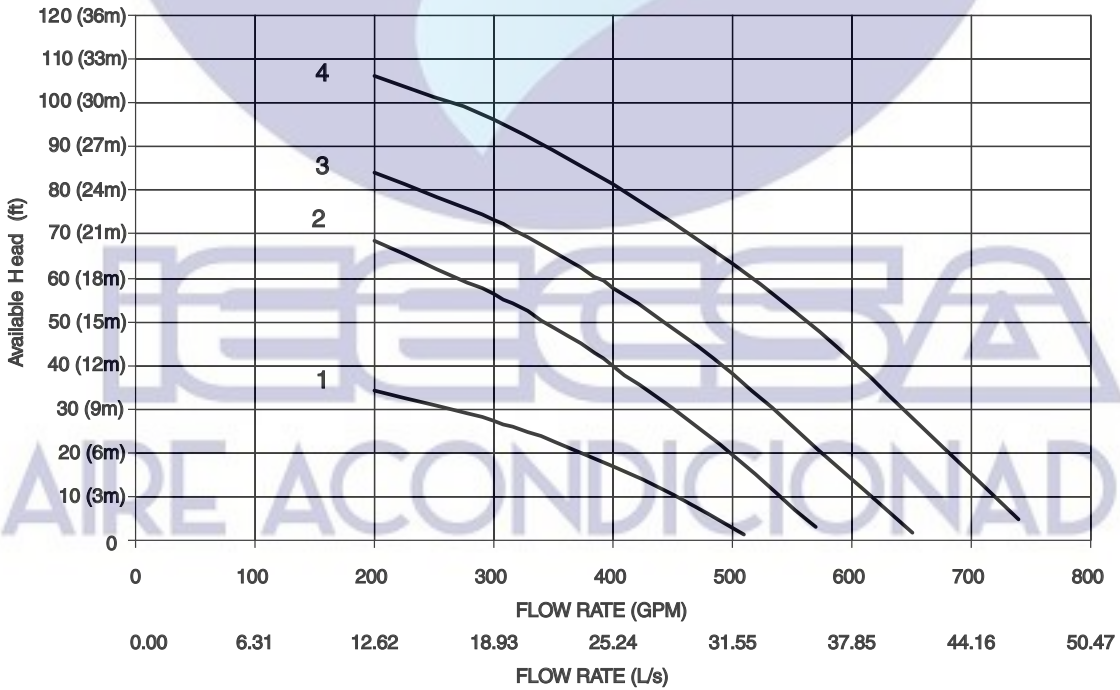

NOTE: Refer to the 30RB nomenclature on page 5 for pump envelope curve option identification.



### 30RB060, 070 — DUAL PUMP ENVELOPE CURVES

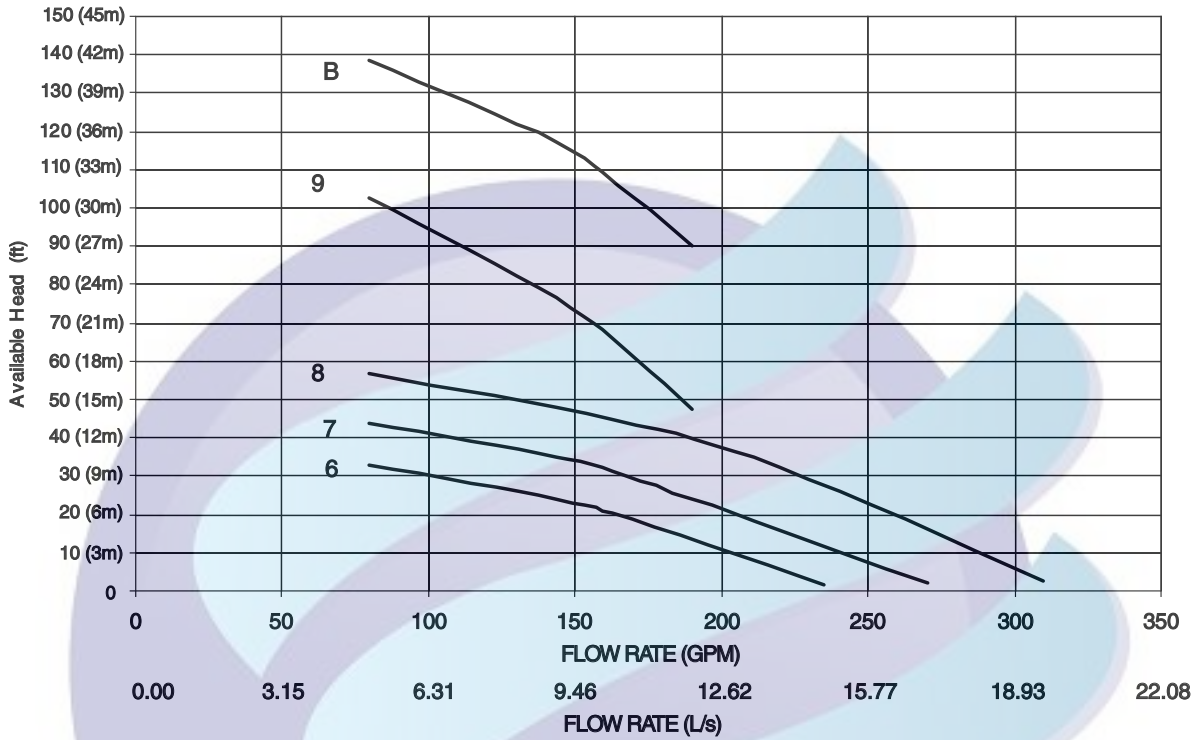

### 30RB080, 090, 100 — DUAL PUMP ENVELOPE CURVES

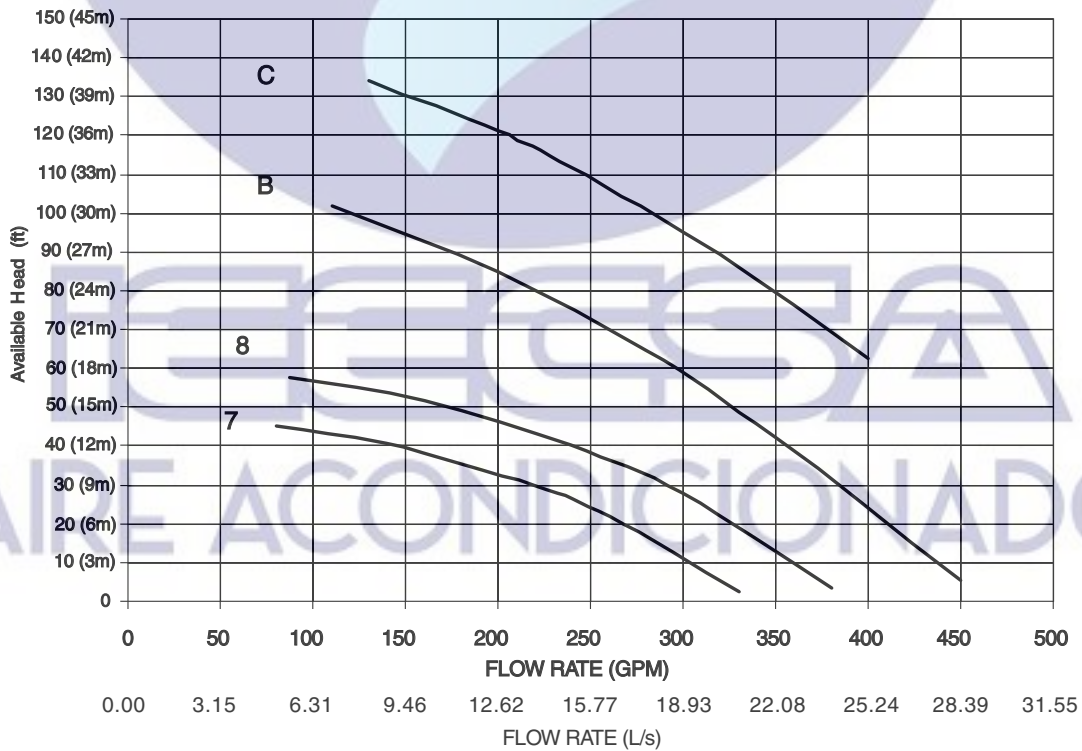

NOTE: Refer to the 30RB nomenclature on page 5 for pump envelope curve option identification.

**30RB110, 120, 130 — DUAL PUMP ENVELOPE CURVES**

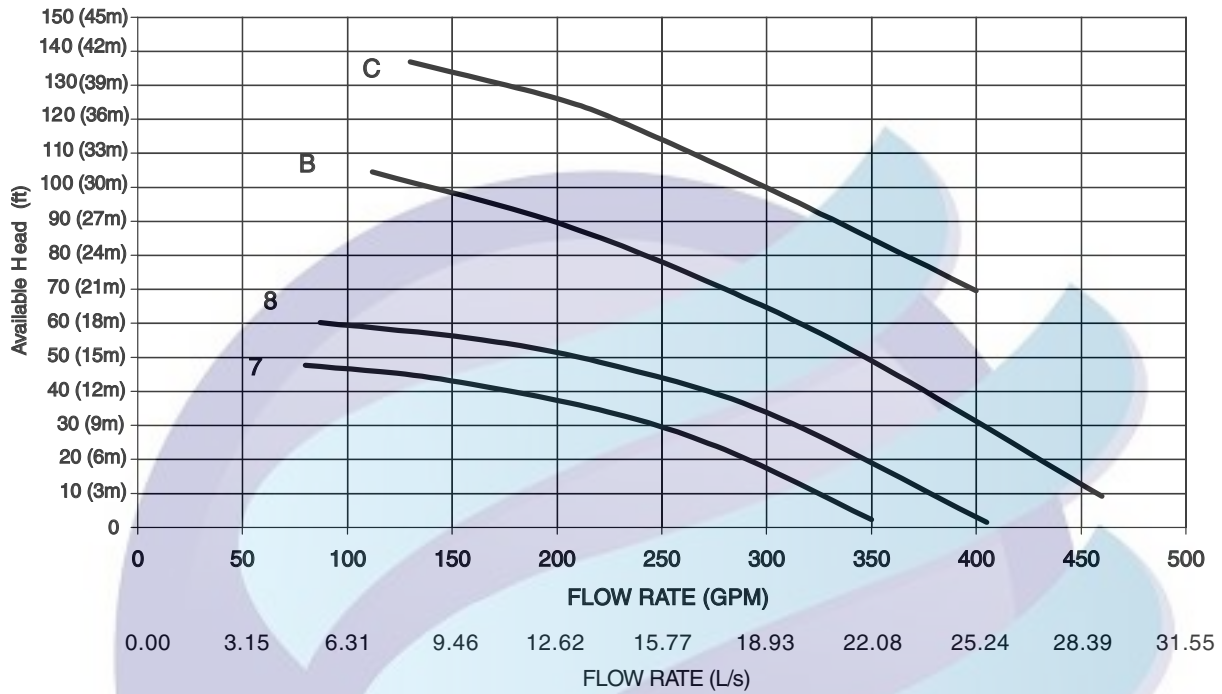

**30RB150, 160, 170, 190 — DUAL PUMP ENVELOPE CURVES**

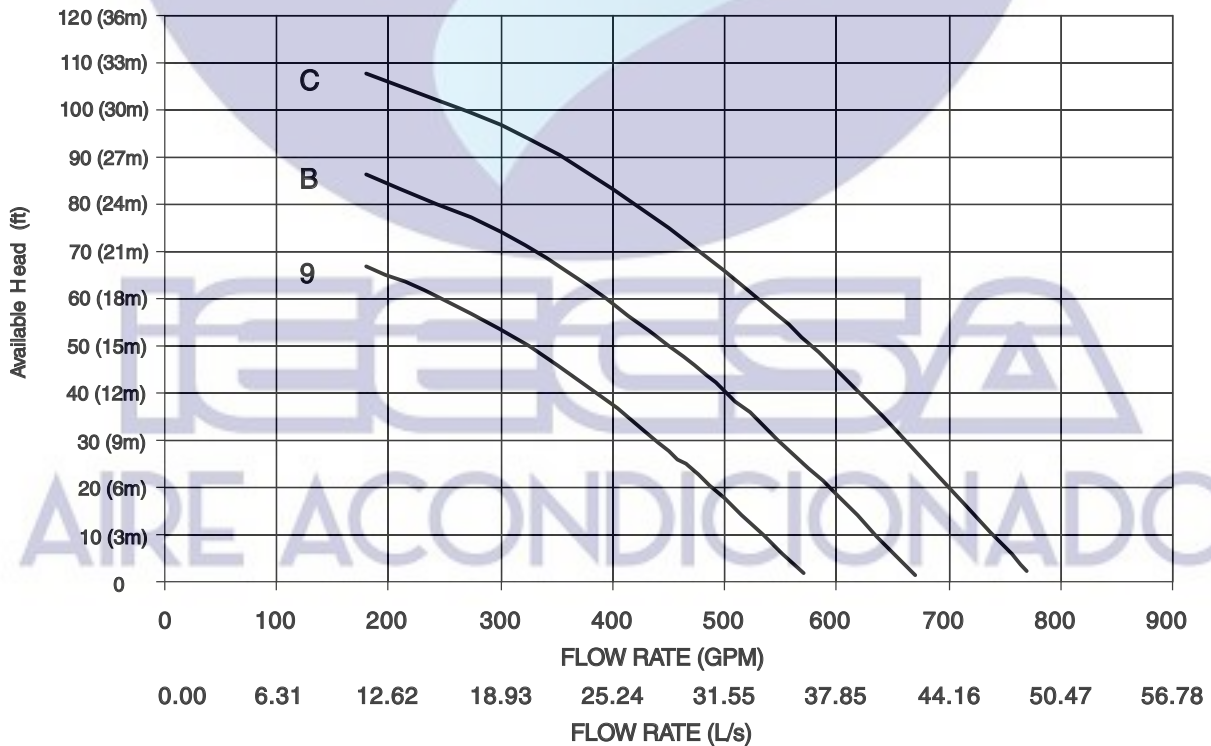

NOTE: Refer to the 30RB nomenclature on page 5 for pump envelope curve option identification.

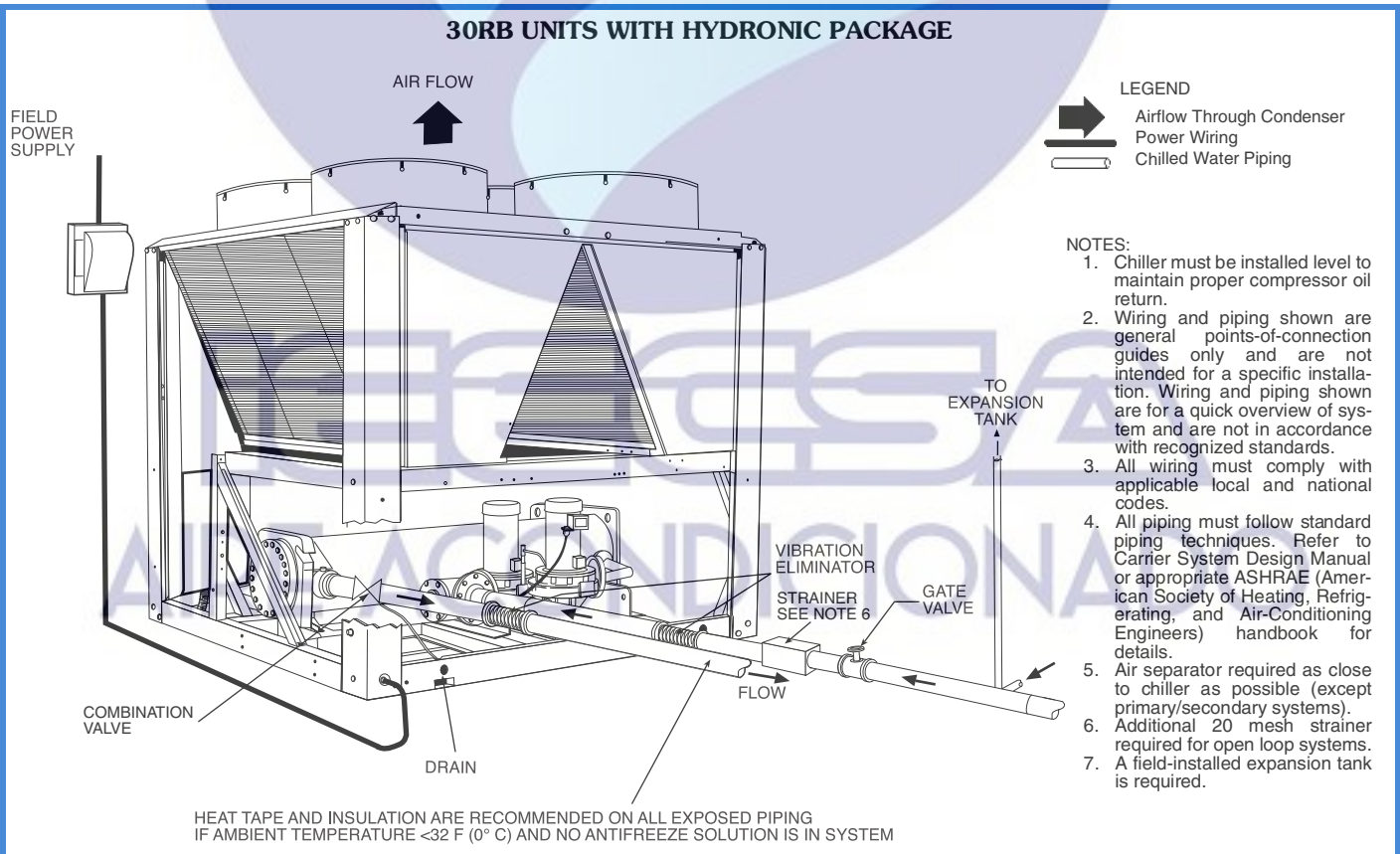
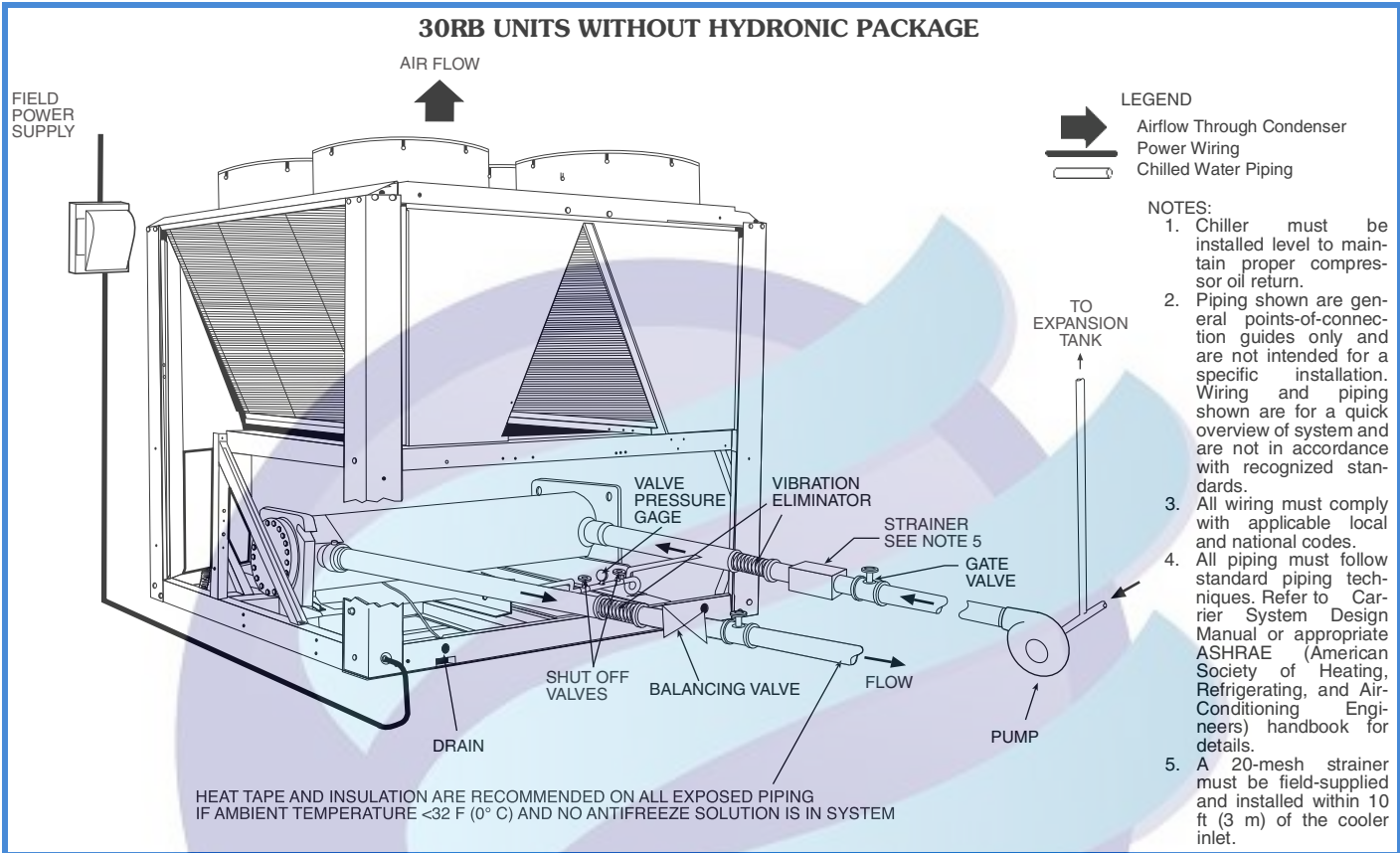

**TYPICAL PIPING DIAGRAM FOR 30RB UNITS WITHOUT HYDRONIC PACKAGE**

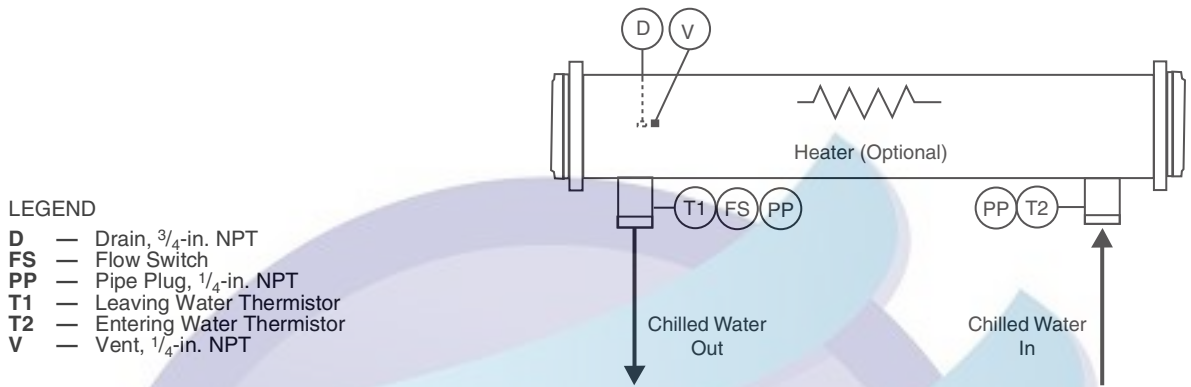

**LEGEND**

- D** — Drain, 3/4-in. NPT
- FS** — Flow Switch
- PP** — Pipe Plug, 1/4-in. NPT
- T1** — Leaving Water Thermistor
- T2** — Entering Water Thermistor
- V** — Vent, 1/4-in. NPT

**TYPICAL PIPING DIAGRAM FOR 30RB UNITS WITH HYDRONIC PACKAGE — SINGLE PUMP**

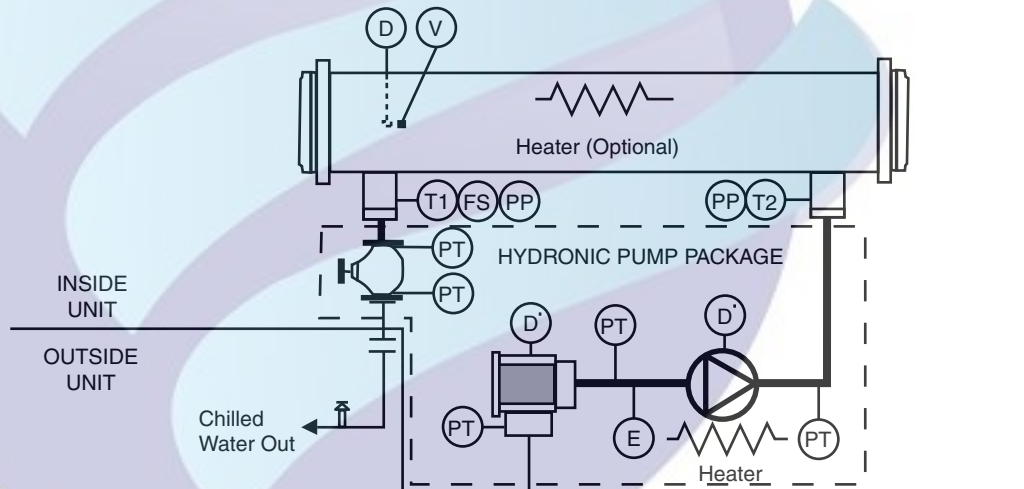

**LEGEND**

- D** — Drain, 3/4-in. NPT
- D'** — Drain, 1/4-in. NPT
- E** — Expansion Tank Connection, 3/4-in. NPT
- FS** — Flow Switch
- PP** — Pipe Plug, 1/4-in. NPT
- PT** — Pressure/Temperature Tap
- T1** — Leaving Water Thermistor
- T2** — Entering Water Thermistor
- V** — Vent, 1/4-in. NPT
- Indicates items provided with the optional hydronic pump package.

\*Field-supplied and installed.  
 †The strainer supplied with the optional hydronic pump package is 1/8 in. perforated.  
 \*\*Required for open loop systems.

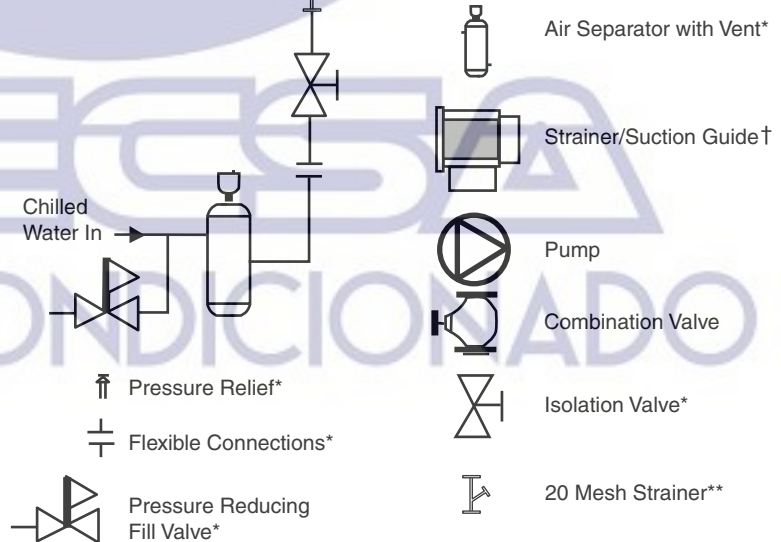

**TYPICAL PIPING DIAGRAM FOR 30RB UNITS WITH HYDRONIC PACKAGE — DUAL PUMPS**

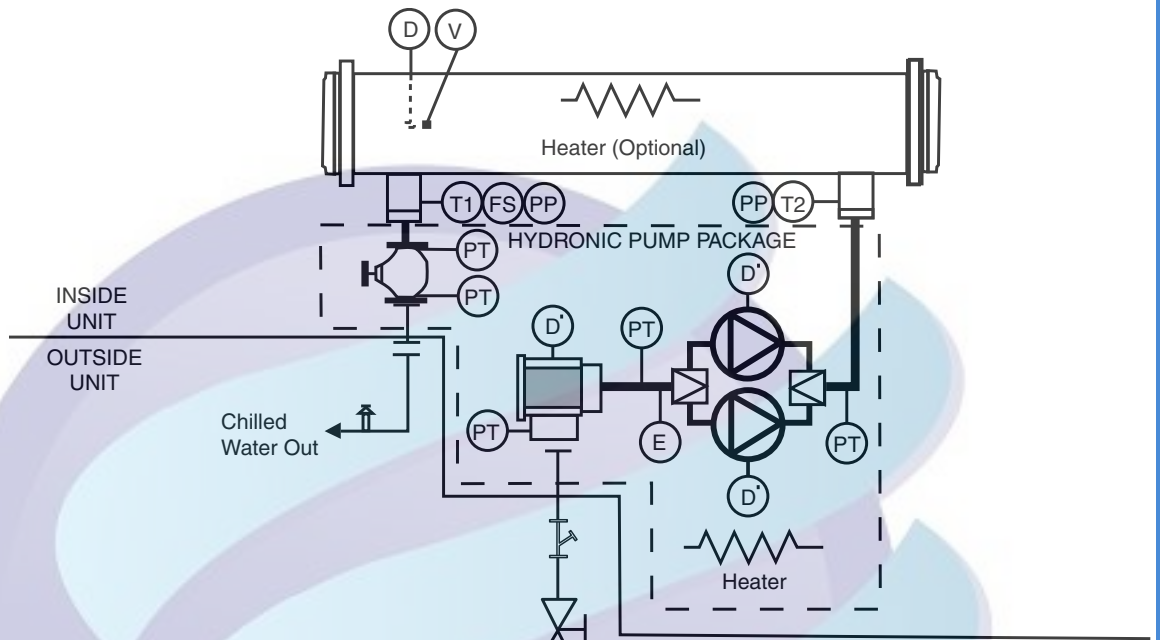

**LEGEND**

- D** — Drain, 3/4-in. NPT
- D'** — Drain, 1/4-in. NPT
- E** — Expansion Tank Connection, 3/4-in. NPT
- FS** — Flow Switch
- PP** — Pipe Plug, 1/4-in. NPT
- PT** — Pressure/Temperature Tap
- T1** — Leaving Water Thermistor
- T2** — Entering Water Thermistor
- V** — Vent, 1/4-in. NPT
- Indicates items provided with the optional hydronic pump package.

\*Field-supplied and installed.  
 †The strainer supplied with the optional hydronic pump package is 1/8 in. perforated.  
 \*\*Required for open loop systems.

- 
- 
- 
- 
- 
- 
- 
- 
- 
- 
- 

AIRE ACONDICIONADO

## 30RB060-190 ELECTRICAL DATA – SINGLE POINT UNITS

30RB UNIT SIZE	UNIT VOLTAGE			NO HYDRONIC PACKAGE				3 HP PUMP, 1750 RPM				5 HP PUMP, 1750 RPM			
	V-Hz (3 Ph)	Supplied		MCA	MOCP	ICF	Rec Fuse Size	MCA	MOCP	ICF	Rec Fuse Size	MCA	MOCP	ICF	Rec Fuse Size
		Min	Max	XL	XL	XL		XL	XL	XL		XL	XL	XL	
060	208/230-60	187	253	291.5	350	682.8	350	300.6	350	693.6	350	306.9	350	700.5	350
	380-60	342	418	150.9	175	362.9	175	156.0	175	368.8	175	159.0	175	372.6	175
	460-60	414	506	127.9	150	302.0	150	132.1	150	306.9	150	135.0	150	310.0	150
	575-60	518	633	102.4	125	244.7	110	105.7	125	248.6	125	107.8	125	251.1	125
070	208/230-60	187	253	334.7	400	777.0	400	343.8	400	787.8	400	350.1	400	794.7	400
	380-60	342	418	175.5	200	428.8	200	108.8	225	434.7	200	183.6	225	438.5	200
	460-60	414	506	147.9	175	355.9	175	152.1	175	360.8	175	155.0	175	363.9	175
	575-60	518	633	119.8	150	287.4	150	123.1	150	291.3	150	125.2	150	293.8	150
080	208/230-60	187	253	366.5	400	757.8	400	—	—	—	—	381.9	450	775.5	450
	380-60	342	418	189.3	225	401.3	200	—	—	—	—	197.4	225	411.0	225
	460-60	414	506	160.6	175	334.7	175	—	—	—	—	167.7	200	342.7	200
	575-60	518	633	128.6	150	270.9	150	—	—	—	—	134.0	150	277.3	150
090	208/230-60	187	253	433.6	500	875.9	500	—	—	—	—	449.0	500	893.6	500
	380-60	342	418	248.7	250	502.1	250	—	—	—	—	235.0	250	490.0	250
	460-60	414	506	191.4	225	399.4	225	—	—	—	—	198.5	225	407.4	225
	575-60	518	633	154.6	175	322.2	175	—	—	—	—	160.0	175	328.6	175
100	208/230-60	187	253	472.0	500	914.3	500	—	—	—	—	487.4	500	932.0	500
	380-60	342	418	248.7	250	502.1	250	—	—	—	—	256.8	300	511.8	300
	460-60	414	506	209.2	250	417.2	225	—	—	—	—	216.3	250	425.2	250
	575-60	518	633	170.0	200	337.6	200	—	—	—	—	175.4	200	344.0	200
110	208/230-60	187	253	508.6	600	950.9	600	—	—	—	—	524.0	600	968.6	600
	380-60	342	418	265.3	300	518.7	300	—	—	—	—	273.4	300	528.4	300
	460-60	414	506	224.1	250	432.1	250	—	—	—	—	231.2	250	440.1	250
	575-60	518	633	180.8	200	348.4	200	—	—	—	—	186.2	200	354.8	200
120	208/230-60	187	253	578.1	600	1020.4	600	—	—	—	—	593.5	600	1038.1	600
	380-60	342	418	304.6	350	538.0	350	—	—	—	—	312.7	350	567.6	350
	460-60	414	506	256.2	300	464.2	300	—	—	—	—	263.3	300	472.2	300
	575-60	518	633	208.2	225	325.8	225	—	—	—	—	213.6	225	382.2	225
130	208/230-60	187	253	626.7	700	1068.9	700	—	—	—	—	642.1	700	1086.6	700
	380-60	342	418	327.7	350	581.1	350	—	—	—	—	335.8	350	590.8	350
	460-60	414	506	276.5	300	484.5	300	—	—	—	—	283.6	300	492.5	300
	575-60	518	633	223.3	250	391.0	250	—	—	—	—	228.7	250	397.4	250
150	208/230-60	187	253	684.3	700	1126.5	700	—	—	—	—	699.7	700	1144.2	700
	380-60	342	418	360.4	400	613.8	400	—	—	—	—	368.5	400	623.5	400
	460-60	414	506	303.2	350	511.2	350	—	—	—	—	310.3	350	519.2	350
	575-60	518	633	246.4	250	414.1	250	—	—	—	—	251.8	300	420.5	300
160	208/230-60	187	253	744.8	800	1187.0	800	—	—	—	—	760.2	800	1204.7	800
	380-60	342	418	390.1	400	643.5	400	—	—	—	—	398.2	400	653.2	400
	460-60	414	506	328.9	350	536.9	350	—	—	—	—	336.0	350	544.9	350
	575-60	518	633	265.9	300	433.5	300	—	—	—	—	271.3	300	439.9	300
170	208/230-60	187	253	802.4	1000	1244.6	1000	—	—	—	—	817.8	1000	1262.3	1000
	380-60	342	418	422.8	450	676.2	450	—	—	—	—	430.9	450	685.9	450
	460-60	414	506	355.6	400	563.6	400	—	—	—	—	362.7	400	571.6	400
	575-60	518	633	289.0	300	456.6	300	—	—	—	—	294.4	300	463.0	300
190	208/230-60	187	253	920.5	1000	1362.7	1000	—	—	—	—	935.9	1000	1380.4	1000
	380-60	342	418	485.2	500	738.5	500	—	—	—	—	493.3	500	748.2	500
	460-60	414	506	408.0	450	616.0	450	—	—	—	—	415.1	450	624.0	450
	575-60	518	633	331.5	350	499.1	350	—	—	—	—	336.9	350	505.5	350

### LEGEND

- ICF — Instantaneous Current Flow
- MCA — Minimum Circuit Amps
- MOCP — Maximum Overcurrent Protection
- XL — Across-the-Line Start

### NOTES:

1. Units are suitable for use on electrical systems where voltage supplied to the unit terminals is not below or above the listed minimum and maximum limits. Maximum allowable phase imbalance is: voltage, 2%; amps 10%.
2. All units have single point primary power connection. (Each unit requires its own power supply.) Main power must be supplied from a field-supplied disconnect.
3. Cooler heater is wired into the control circuit so it is always operable as long as the power supply disconnect is on, even if any safety device is open.
4. For MCA that is less than or equal to 380 amps, 3 conductors are required.  
For MCA between 381 and 760 amps, 6 conductors are required.  
For MCA between 761 and 1140 amps, 9 conductors are required.  
For MCA between 1141 and 1520 amps, 12 conductors are required.  
Calculation of conductors required is based on 75°C copper wire.
5. Wiring for main field supply must be rated 75°C minimum. Use copper for all units.
  - a. Incoming wire size range for the terminal block is no. 4 AWG (American Wire Gauge) to 500 kcmil.
  - b. Incoming wire size range of non-fused disconnect with MCA up to 599.9 amps is 3/0 to 500 kcmil.
  - c. Incoming wire size range of non-fused disconnect with MCA from 600 to 799.9 amps is 1/0 to 500 kcmil.
  - d. Incoming wire size range of non-fused disconnect with MCA from 800 to 1199.9 amps is 250 kcmil to 500 kcmil.
6. Hydronic pump packages are not available as a factory-installed option for units 30RB210-300 and 30RB060-190 with high SCCR option.
7. Power draw includes both crankcase heaters and cooler heaters. Each compressor has a crankcase heater which draws 56 watts of power. Units have 1 (060-150) or 2 (160-300) cooler heaters, 825 watts each.
8. 30RB chillers with Greenspeed® intelligence are not available in size 060 and 070.



### 30RB060-190 ELECTRICAL DATA — SINGLE POINT UNITS (cont)

30RB UNIT SIZE	UNIT VOLTAGE			7.5 HP PUMP, 1750/3450 RPM				10 HP PUMP, 3450 RPM				15 HP PUMP, 3450 RPM			
	V-Hz (3 Ph)	Supplied		MCA	MOCP	ICF	Rec Fuse Size	MCA	MOCP	ICF	Rec Fuse Size	MCA	MOCP	ICF	Rec Fuse Size
		Min	Max	XL	XL	XL		XL	XL	XL		XL	XL	XL	
060	208/230-60	187	253	313.5	350	708.5	350	316.5	350	716.4	350	—	—	—	—
	380-60	342	418	163.2	200	376.9	175	164.9	200	381.3	175	—	—	—	—
	460-60	414	506	138.0	150	313.6	150	139.4	150	317.2	150	—	—	—	—
	575-60	518	633	110.5	125	254.0	125	111.6	125	256.9	125	—	—	—	—
070	208/230-60	187	253	356.7	450	802.7	400	359.7	450	810.6	400	—	—	—	—
	380-60	342	418	187.8	225	442.8	225	189.5	225	447.2	225	—	—	—	—
	460-60	414	506	158.0	175	367.5	175	159.4	200	371.1	175	—	—	—	—
	575-60	518	633	127.9	150	296.7	150	129.0	150	299.6	150	—	—	—	—
080	208/230-60	187	253	388.5	450	783.5	450	391.5	450	791.4	450	403.2	450	807.6	450
	380-60	342	418	201.6	225	415.3	225	203.3	225	419.7	225	210.3	225	428.5	225
	460-60	414	506	170.7	200	346.3	200	172.1	200	349.9	200	177.6	200	357.2	200
	575-60	518	633	136.7	150	280.2	150	137.8	150	283.1	150	142.6	150	288.9	150
090	208/230-60	187	253	455.6	500	901.6	500	458.6	500	909.5	500	470.3	500	925.7	500
	380-60	342	418	239.2	250	494.3	250	240.9	250	498.7	250	247.9	250	507.5	300
	460-60	414	506	201.5	225	411.0	225	202.9	225	414.6	225	208.4	250	421.9	225
	575-60	518	633	162.7	175	331.5	175	163.8	175	334.4	175	168.6	200	340.2	200
100	208/230-60	187	253	494.0	500	940.0	500	497.0	500	947.9	500	508.7	600	964.1	600
	380-60	342	418	261.0	300	516.1	300	262.7	300	520.5	300	269.7	300	529.3	300
	460-60	414	506	219.3	250	428.8	250	220.7	250	432.4	250	226.2	250	439.7	250
	575-60	518	633	178.1	200	346.9	200	179.2	200	349.8	200	184.0	200	355.6	200
110	208/230-60	187	253	530.6	600	976.6	600	533.6	600	984.5	600	545.3	600	1000.7	600
	380-60	342	418	277.6	300	532.7	300	279.3	300	537.1	300	286.3	300	545.9	300
	460-60	414	506	234.2	250	443.7	250	235.6	250	447.3	250	241.1	250	454.6	250
	575-60	518	633	188.9	200	357.7	200	190.0	200	360.6	200	194.8	225	366.4	225
120	208/230-60	187	253	600.1	700	1046.1	700	603.1	700	1054.0	700	614.8	700	1070.2	700
	380-60	342	418	316.9	350	572.0	350	318.6	350	576.4	350	325.6	350	585.2	350
	460-60	414	506	266.3	300	425.8	300	267.7	300	479.4	300	273.2	300	486.7	300
	575-60	518	633	216.3	225	385.1	225	217.4	250	392.4	250	222.2	250	393.8	250
130	208/230-60	187	253	648.7	700	1094.6	700	651.7	700	1102.5	700	663.4	700	1118.7	700
	380-60	342	418	340.0	350	595.1	350	341.7	350	599.5	350	348.7	350	608.3	400
	460-60	414	506	286.6	300	496.1	300	288.0	300	499.7	300	293.5	300	507.0	300
	575-60	518	633	231.4	250	400.3	250	232.5	250	403.2	250	237.3	250	409.0	250
150	208/230-60	187	253	706.3	800	1152.2	800	709.3	800	1160.1	800	721.0	800	1176.3	800
	380-60	342	418	372.7	400	627.8	400	374.4	400	632.2	400	381.4	400	641.0	400
	460-60	414	506	313.3	350	522.8	350	314.7	350	526.4	350	320.2	350	533.7	350
	575-60	518	633	254.5	300	423.4	300	255.6	300	426.3	300	260.4	300	432.1	300
160	208/230-60	187	253	766.8	800	1212.7	800	769.8	800	1220.6	800	781.5	800	1236.8	800
	380-60	342	418	402.4	450	657.5	450	404.1	450	661.9	450	411.1	450	670.7	450
	460-60	414	506	339.0	350	548.5	350	340.4	350	552.1	350	345.9	350	559.4	350
	575-60	518	633	274.0	300	442.8	300	275.1	300	445.7	300	279.9	300	451.5	300
170	208/230-60	187	253	824.4	1000	1270.3	1000	827.4	1000	1278.2	1000	839.1	1000	1294.4	1000
	380-60	342	418	435.1	450	690.2	450	436.8	450	694.6	450	443.8	450	703.4	500
	460-60	414	506	365.7	400	575.2	400	367.1	400	578.8	400	372.6	400	586.1	400
	575-60	518	633	297.1	300	465.9	300	298.2	300	468.8	300	303.0	350	474.6	350
190	208/230-60	187	253	942.5	1000	1388.4	1000	945.5	1000	1396.3	1000	957.2	1000	1412.5	1000
	380-60	342	418	497.5	500	752.5	500	499.2	500	756.9	600	506.2	600	765.7	600
	460-60	414	506	418.1	450	627.6	450	419.5	450	631.2	450	425.0	450	638.5	450
	575-60	518	633	339.6	350	508.4	350	340.7	350	511.3	350	345.5	350	517.1	350

**LEGEND**

- ICF — Instantaneous Current Flow
- MCA — Minimum Circuit Amps
- MOCP — Maximum Overcurrent Protection
- XL — Across-the-Line Start

**NOTES:**

1. Units are suitable for use on electrical systems where voltage supplied to the unit terminals is not below or above the listed minimum and maximum limits. Maximum allowable phase imbalance is: voltage, 2%; amps 10%.
2. All units have single point primary power connection. (Each unit requires its own power supply.) Main power must be supplied from a field-supplied disconnect.
3. Cooler heater is wired into the control circuit so it is always operable as long as the power supply disconnect is on, even if any safety device is open.
4. For MCA that is less than or equal to 380 amps, 3 conductors are required.  
For MCA between 381 and 760 amps, 6 conductors are required.  
For MCA between 761 and 1140 amps, 9 conductors are required.  
For MCA between 1141 and 1520 amps, 12 conductors are required.  
Calculation of conductors required is based on 75°C copper wire.
5. Wiring for main field supply must be rated 75°C minimum. Use copper for all units.
  - a. Incoming wire size range for the terminal block is no. 4 AWG (American Wire Gage) to 500 kcmil.
  - b. Incoming wire size range of non-fused disconnect with MCA up to 599.9 amps is 3/0 to 500 kcmil.
  - c. Incoming wire size range of non-fused disconnect with MCA from 600 to 799.9 amps is 1/0 to 500 kcmil.
  - d. Incoming wire size range of non-fused disconnect with MCA from 800 to 1199.9 amps is 250 kcmil to 500 kcmil.
6. Hydronic pump packages are not available as a factory-installed option for units 30RB210-300 and 30RB060-190 with high SCCR option.
7. Power draw includes both crankcase heaters and cooler heaters. Each compressor has a crankcase heater which draws 56 watts of power. Units have 1 (060-150) or 2 (160-300) cooler heaters, 825 watts each.
8. 30RB chillers with Greenspeed intelligence are not available in size 060 and 070.



## 30RB210-300 ELECTRICAL DATA — SINGLE POINT UNITS

30RB UNIT SIZE	UNIT VOLTAGE			NO HYDRONIC PACKAGE			
	V-Hz (3 Ph)	Supplied		MCA	MOCP	ICF	Rec Fuse Size
		Min	Max	XL	XL	XL	
210	208/230-60	187	253	—	—	—	—
	380-60	342	418	501.8	600	755.1	600
	460-60	414	506	422.9	450	630.9	450
	575-60	518	633	342.3	350	509.9	350
225	208/230-60	187	253	—	—	—	—
	380-60	342	418	534.5	600	787.8	600
	460-60	414	506	449.6	450	657.6	450
	575-60	518	633	365.4	400	533.0	400
250	208/230-60	187	253	—	—	—	—
	380-60	342	418	596.8	600	850.2	600
	460-60	414	506	502.0	600	710.0	600
	575-60	518	633	408.0	450	575.6	450
275	208/230-60	187	253	—	—	—	—
	380-60	342	418	659.2	700	912.6	700
	460-60	414	506	554.4	600	762.4	600
	575-60	518	633	450.5	500	618.1	500
300	208/230-60	187	253	—	—	—	—
	380-60	342	418	721.6	800	975.0	800
	460-60	414	506	606.8	700	814.8	700
	575-60	518	633	493.0	500	660.7	500

### LEGEND

**ICF** — Instantaneous Current Flow  
**MCA** — Minimum Circuit Amps  
**MOCP** — Maximum Overcurrent Protection  
**XL** — Across-the-Line Start

### NOTES:

- Units are suitable for use on electrical systems where voltage supplied to the unit terminals is not below or above the listed minimum and maximum limits. Maximum allowable phase imbalance is: voltage, 2%; amps 10%.
- All units have single point primary power connection. (Each unit requires its own power supply.) Main power must be supplied from a field-supplied disconnect.
- Cooler heater is wired into the control circuit so it is always operable as long as the power supply disconnect is on, even if any safety device is open.
- For MCA that is less than or equal to 380 amps, 3 conductors are required.  
 For MCA between 381 and 760 amps, 6 conductors are required.  
 For MCA between 761 and 1140 amps, 9 conductors are required.  
 For MCA between 1141 and 1520 amps, 12 conductors are required.  
 Calculation of conductors required is based on 75°C copper wire.

- Wiring for main field supply must be rated 75°C minimum. Use copper for all units.
  - Incoming wire size range for the terminal block is no. 4 AWG (American Wire Gage) to 500 kcmil.
  - Incoming wire size range of non-fused disconnect with MCA up to 599.9 amps is 3/0 to 500 kcmil.
  - Incoming wire size range of non-fused disconnect with MCA from 600 to 799.9 amps is 1/0 to 500 kcmil.
  - Incoming wire size range of non-fused disconnect with MCA from 800 to 1199.9 amps is 250 kcmil to 500 kcmil.
- Hydronic pump packages are not available as a factory-installed option for units 30RB210-300 and 30RB060-190 with high SCCR option.
- Power draw includes both crankcase heaters and cooler heaters. Each compressor has a crankcase heater which draws 56 watts of power. Units have 1 (060-150) or 2 (160-300) cooler heaters, 825 watts each.
- 30RB chillers with Greenspeed intelligence are not available in size 060 and 070.



# AIRE ACONDICIONADO





### 30RB060-190 ELECTRICAL DATA — DUAL POINT UNITS

30RB UNIT SIZE	UNIT VOLTAGE			NO HYDRONIC PACKAGE				3 HP PUMP, 1750 RPM				5 HP PUMP, 1750 RPM			
	V-Hz (3 Ph)	Supplied		MCA	MOCP	ICF	Rec Fuse Size	MCA	MOCP	ICF	Rec Fuse Size	MCA	MOCP	ICF	Rec Fuse Size
		Min	Max	XL	XL	XL		XL	XL	XL		XL	XL	XL	
060	208/230-60	187	253	168.8/141.5	225/200	560.0/532.8	200/175	177.9/141.5	250/200	570.8/532.8	200/175	184.2/141.5	250/200	577.7/532.8	225/175
	380-60	342	418	86.4/ 74.1	110/110	298.4/286.1	110/ 90	91.5/ 74.1	125/110	304.3/286.1	110/ 90	94.5/ 74.1	125/110	308.1/286.1	110/ 90
	460-60	414	506	73.6/ 62.5	100/ 90	247.7/236.6	90/ 80	77.8/ 62.5	110/ 90	252.6/236.6	90/ 80	80.7/ 62.5	110/ 90	255.7/236.6	90/ 80
	575-60	518	633	59.0/ 50.0	80/ 70	201.2/192.3	70/ 60	62.3/ 50.0	80/ 70	205.1/192.3	70/ 60	64.4/ 50.0	90/ 70	207.6/192.3	80/ 60
070	208/230-60	187	253	212.0/141.5	300/200	654.2/532.8	250/175	221.1/141.5	300/200	665.0/532.8	250/175	227.4/141.5	300/200	671.9/532.8	300/175
	380-60	342	418	110.9/ 74.1	150/110	364.3/286.1	125/ 90	116.0/ 74.1	150/110	370.2/286.1	150/ 90	119.0/ 74.1	150/110	374.0/286.1	150/ 90
	460-60	414	506	93.6/ 62.5	125/ 90	301.6/236.6	110/ 80	97.8/ 62.5	125/ 90	306.5/236.6	110/ 80	100.7/ 62.5	125/ 90	309.6/236.6	125/ 80
	575-60	518	633	76.3/ 50.0	110/ 70	243.9/192.3	90/ 60	79.6/ 50.0	110/ 70	247.8/192.3	90/ 60	81.7/ 50.0	110/ 70	250.3/192.3	100/ 60
080	208/230-60	187	253	216.5/168.8	250/225	607.8/560.0	250/200	—	—	—	—	231.9/168.8	300/225	625.5/560.0	300/200
	380-60	342	418	112.5/ 86.4	150/110	324.5/298.4	125/100	—	—	—	—	120.6/ 86.4	150/110	334.2/298.4	150/100
	460-60	414	506	95.2/ 73.6	125/100	269.3/247.7	110/ 90	—	—	—	—	102.6/ 73.6	125/100	277.3/247.7	125/ 90
	575-60	518	633	76.2/ 59.0	100/ 80	218.5/201.2	90/ 70	—	—	—	—	81.6/ 59.0	100/ 80	224.9/201.2	90/ 70
090	208/230-60	187	253	283.6/168.8	350/225	725.9/560.0	350/200	—	—	—	—	299.0/168.8	350/225	743.5/560.0	350/200
	380-60	342	418	150.1/ 86.4	175/110	403.5/298.4	175/100	—	—	—	—	158.2/ 86.4	200/110	413.2/298.4	175/100
	460-60	414	506	126.0/ 73.6	150/100	334.0/247.7	150/ 90	—	—	—	—	133.1/ 73.6	150/100	342.0/247.7	150/ 90
	575-60	518	633	102.2/ 59.0	125/ 80	269.8/201.2	125/ 70	—	—	—	—	107.6/ 59.0	125/ 80	276.2/201.2	125/ 70
100	208/230-60	187	253	283.6/212.0	350/300	725.9/654.2	350/250	—	—	—	—	299.0/212.0	350/300	743.5/654.2	350/250
	380-60	342	418	150.1/110.9	175/150	403.5/364.3	175/125	—	—	—	—	158.2/110.9	200/150	413.2/364.3	175/125
	460-60	414	506	126.0/ 93.6	150/125	334.0/301.6	150/110	—	—	—	—	133.1/ 93.6	150/125	342.0/301.6	150/110
	575-60	518	633	102.2/ 76.3	125/110	269.8/243.9	125/ 90	—	—	—	—	107.6/ 76.3	125/110	276.2/243.9	125/ 90
110	208/230-60	187	253	283.6/243.8	350/300	725.9/635.0	350/300	—	—	—	—	299.0/243.8	350/300	743.5/635.0	350/300
	380-60	342	418	150.1/124.8	175/150	403.5/336.8	175/150	—	—	—	—	158.2/124.8	200/150	413.2/336.8	175/150
	460-60	414	506	126.0/106.3	150/125	334.0/280.4	150/125	—	—	—	—	133.1/106.3	150/125	342.0/280.4	150/125
	575-60	518	633	102.2/ 85.2	125/110	269.8/227.4	125/100	—	—	—	—	107.6/ 85.2	125/110	276.2/227.4	125/100
120	208/230-60	187	253	295.5/306.2	350/400	737.8/748.4	350/350	—	—	—	—	310.9/306.2	400/400	755.5/748.4	350/350
	380-60	342	418	156.7/160.2	200/200	410.1/413.6	175/175	—	—	—	—	164.8/160.2	200/200	419.7/413.6	200/175
	460-60	414	506	131.4/135.2	150/175	339.4/343.2	150/150	—	—	—	—	138.5/135.2	175/175	347.4/343.2	150/150
	575-60	518	633	106.5/110.2	125/125	274.1/277.8	125/125	—	—	—	—	111.9/110.2	125/125	280.5/277.8	125/125
130	208/230-60	187	253	401.7/243.8	450/300	843.9/635.0	450/300	—	—	—	—	417.1/243.8	500/300	861.6/635.0	450/300
	380-60	342	418	212.5/124.8	250/150	465.9/336.8	225/150	—	—	—	—	220.6/124.8	250/150	475.6/336.8	250/150
	460-60	414	506	178.4/106.3	200/125	386.4/280.4	200/125	—	—	—	—	185.5/106.3	225/125	394.4/280.4	200/125
	575-60	518	633	144.7/ 85.2	175/110	312.4/227.4	175/100	—	—	—	—	150.1/ 85.2	175/110	318.8/227.4	175/100
150	208/230-60	187	253	401.7/306.2	450/400	843.9/748.4	450/350	—	—	—	—	417.1/306.2	500/400	861.6/748.4	450/350
	380-60	342	418	212.5/160.2	250/200	465.9/413.6	225/175	—	—	—	—	220.6/160.2	250/200	475.6/413.6	250/175
	460-60	414	506	178.4/135.2	200/175	386.4/343.2	200/150	—	—	—	—	185.5/135.2	225/175	394.4/343.2	200/150
	575-60	518	633	144.7/110.2	175/125	312.4/277.8	175/125	—	—	—	—	150.1/110.2	175/125	318.8/277.8	175/125
160	208/230-60	187	253	519.8/243.8	600/300	962.0/635.0	600/300	—	—	—	—	535.2/243.8	600/300	979.7/635.0	600/300
	380-60	342	418	274.9/124.8	300/150	528.3/336.8	300/150	—	—	—	—	283.0/124.8	300/150	538.0/336.8	300/150
	460-60	414	506	230.8/106.3	250/125	438.8/280.4	250/125	—	—	—	—	237.9/106.3	250/125	446.8/280.4	250/125
	575-60	518	633	187.3/ 85.2	200/110	354.9/227.4	200/100	—	—	—	—	192.7/ 85.2	225/110	361.3/227.4	225/100
170	208/230-60	187	253	519.8/306.2	600/400	962.0/748.4	600/350	—	—	—	—	535.2/306.2	600/400	979.7/748.4	600/350
	380-60	342	418	274.9/160.2	300/200	528.3/413.6	300/175	—	—	—	—	283.0/160.2	300/200	538.0/413.6	300/175
	460-60	414	506	230.8/135.2	250/175	438.8/343.2	250/150	—	—	—	—	237.9/135.2	250/175	446.8/343.2	250/150
	575-60	518	633	187.3/110.2	200/125	354.9/277.8	200/125	—	—	—	—	192.7/110.2	225/125	361.3/277.8	225/125
190	208/230-60	187	253	543.7/400.4	600/450	985.9/842.6	600/450	—	—	—	—	559.1/400.4	600/450	1003.6/842.6	600/450
	380-60	342	418	288.0/209.5	300/250	541.3/462.9	300/225	—	—	—	—	296.1/209.5	300/250	551.0/462.9	300/225
	460-60	414	506	241.6/176.8	250/200	449.6/384.8	250/200	—	—	—	—	248.7/176.8	250/200	457.6/384.8	250/200
	575-60	518	633	195.9/144.1	225/175	363.5/311.7	225/175	—	—	—	—	201.3/144.1	225/175	369.9/311.7	225/175

**LEGEND**

**ICF** — Instantaneous Current Flow (Ckt1/Ckt2)  
**MCA** — Minimum Circuit Amps (Ckt1/Ckt2)  
**MOCP** — Maximum Overcurrent Protection (Ckt1/Ckt2)  
**XL** — Across-the-Line Start

**NOTES:**

- Units are suitable for use on electrical systems where voltage supplied to the unit terminals is not below or above the listed minimum and maximum limits. Maximum allowable phase imbalance is: voltage, 2%; amps 10%.
- Control power is derived from main power. No separate control power connection is required.
- Cooler heater is wired into the control circuit so it is always operable as long as the power supply disconnect is on, even if any safety device is open.
- For MCA that is less than or equal to 380 amps, 3 conductors are required.  
 For MCA between 381 and 760 amps, 6 conductors are required.  
 For MCA between 761 and 1140 amps, 9 conductors are required.  
 For MCA between 1141 and 1520 amps, 12 conductors are required.  
 Calculation of conductors required is based on 75 C copper wire.

- Wiring for main field supply must be rated 75 C minimum. Use copper for all units.
  - Incoming wire size range for the terminal block is no. 4 AWG (American Wire Gage) to 500 kcmil.
  - Incoming wire size range of non-fused disconnect with MCA up to 599.9 amps is 3/0 to 500 kcmil.
  - Incoming wire size range of non-fused disconnect with MCA from 600 to 799.9 amps is 1/0 to 500 kcmil.
  - Incoming wire size range of non-fused disconnect with MCA from 800 to 1199.9 amps is 250 kcmil to 500 kcmil.
- Hydronic pump packages are not available as a factory-installed option for units 30RB210-300.
- Power draw includes both crankcase heaters and cooler heaters (where used). Each compressor has a crankcase heater which draws 56 watts of power. Units ordered with the cooler heater option have 1 (060-150) or 2 (160-300) cooler heaters, 825 watts each.
- 30RB chillers with Greenspeed® technology are not available in size 060 and 070.



# AIRE ACONDICIONADO

## 30RB060-190 ELECTRICAL DATA — DUAL POINT UNITS (cont)

30RB UNIT SIZE	UNIT VOLTAGE		7.5 HP PUMP, 1750/3450 RPM				10 HP PUMP, 3450 RPM				15 HP PUMP, 3450 RPM						
	V-Hz (3 Ph)	Supplied	MCA		MOCP	ICF	Rec Fuse Size	MCA		MOCP	ICF	Rec Fuse Size	MCA		MOCP	ICF	Rec Fuse Size
		Min	Max	XL	XL	XL		XL	XL	XL	XL		XL	XL	XL	XL	
060	208/230-60	187	253	190.8/141.5	250/200	585.7/532.8	225/175	193.8/141.5	250/200	593.6/532.8	225/175	—	—	—	—	—	—
	380-60	342	418	98.7/ 74.1	125/110	312.4/286.1	110/ 90	100.4/ 74.1	125/110	316.8/286.1	110/ 90	—	—	—	—	—	—
	460-60	414	506	83.7/ 62.5	110/ 90	259.3/236.6	100/ 80	85.1/ 62.5	110/ 90	262.9/236.6	100/ 80	—	—	—	—	—	—
	575-60	518	633	67.1/ 50.0	90/ 70	210.5/192.3	80/ 60	68.2/ 50.0	90/ 70	213.4/192.3	80/ 60	—	—	—	—	—	—
070	208/230-60	187	253	234.0/141.5	300/200	679.9/532.8	300/175	237.0/141.5	300/200	687.8/532.8	300/175	—	—	—	—	—	—
	380-60	342	418	123.2/ 74.1	150/110	378.3/286.1	150/ 90	124.9/ 74.1	150/110	382.7/286.1	150/ 90	—	—	—	—	—	—
	460-60	414	506	103.7/ 62.5	125/ 90	313.2/236.6	125/ 80	105.1/ 62.5	125/ 90	316.8/236.6	125/ 80	—	—	—	—	—	—
	575-60	518	633	84.4/ 50.0	110/ 70	253.2/192.3	100/ 60	85.5/ 50.0	110/ 70	256.1/192.3	100/ 60	—	—	—	—	—	—
080	208/230-60	187	253	238.5/168.8	300/225	633.4/560.0	300/200	241.5/168.8	300/225	641.4/560.0	300/200	253.2/168.8	300/225	657.5/560.0	300/200	—	—
	380-60	342	418	123.2/ 74.1	150/110	378.3/286.1	150/100	126.5/ 86.4	150/110	382.9/286.1	150/100	133.5/ 86.4	150/110	351.8/298.4	150/100	—	—
	460-60	414	506	105.3/ 73.6	125/100	280.9/247.7	125/ 90	106.7/ 73.6	125/100	284.5/247.7	125/ 90	112.2/ 73.6	125/100	291.8/247.7	125/ 90	—	—
	575-60	518	633	84.3/ 59.0	110/ 80	227.8/201.2	100/ 70	85.4/ 59.0	110/ 80	230.6/201.2	100/ 70	90.2/ 59.0	110/ 80	236.5/201.2	100/ 70	—	—
090	208/230-60	187	253	305.6/168.8	350/225	751.5/560.0	350/200	308.6/168.8	400/225	759.5/560.0	350/200	320.3/168.8	400/225	775.6/560.0	350/200	—	—
	380-60	342	418	162.4/ 86.4	200/110	417.6/298.4	175/100	164.1/ 86.4	200/110	421.9/298.4	200/100	171.1/ 86.4	200/110	430.8/298.4	200/100	—	—
	460-60	414	506	136.1/ 73.6	175/100	345.6/247.7	150/ 90	137.5/ 73.6	175/100	349.2/247.7	150/ 90	143.0/ 73.6	175/100	356.5/247.7	175/ 90	—	—
	575-60	518	633	110.3/ 59.0	125/ 80	279.1/201.2	125/ 70	111.4/ 59.0	125/ 80	282.0/201.2	125/ 70	116.2/ 59.0	150/ 80	287.8/201.2	125/ 70	—	—
100	208/230-60	187	253	305.6/212.0	350/300	751.5/654.2	350/250	308.6/212.0	400/300	759.5/654.2	350/250	320.3/212.0	400/300	775.6/654.2	350/250	—	—
	380-60	342	418	162.4/110.9	200/150	417.6/364.3	175/125	164.1/110.9	200/150	421.9/364.3	200/125	171.1/110.9	200/150	430.8/364.3	200/125	—	—
	460-60	414	506	136.1/ 93.6	175/125	345.6/301.6	150/110	137.5/ 93.6	175/125	349.2/301.6	150/110	143.0/ 93.6	175/125	356.5/301.6	175/110	—	—
	575-60	518	633	110.3/ 76.3	125/110	279.1/243.9	125/ 90	111.4/ 76.3	125/110	282.0/243.9	125/ 90	116.2/ 76.3	150/110	287.8/243.9	125/ 90	—	—
110	208/230-60	187	253	305.6/243.8	350/300	751.5/635.0	350/300	308.6/243.8	400/300	759.5/635.0	350/300	320.3/243.8	400/300	775.6/635.0	350/300	—	—
	380-60	342	418	162.4/124.8	200/150	417.6/336.8	175/150	164.1/124.8	200/150	421.9/336.8	200/150	171.1/124.8	200/150	430.8/336.8	200/150	—	—
	460-60	414	506	136.1/106.3	175/125	345.6/280.4	150/125	137.5/106.3	175/125	349.2/280.4	150/125	143.0/106.3	175/125	356.5/280.4	175/125	—	—
	575-60	518	633	110.3/ 85.2	125/110	279.1/227.4	125/100	111.4/ 85.2	125/110	282.0/227.4	125/100	116.2/ 85.2	150/110	287.8/227.4	125/100	—	—
120	208/230-60	187	253	317.5/306.2	400/400	763.5/748.4	350/350	320.5/306.2	400/400	771.4/748.4	350/350	332.2/306.2	400/400	787.6/748.4	400/350	—	—
	380-60	342	418	169.0/160.2	200/200	424.1/413.6	200/175	170.7/160.2	200/200	428.5/413.6	200/175	177.7/160.2	225/200	493.1/413.6	200/175	—	—
	460-60	414	506	141.5/135.2	175/175	351.0/343.2	175/150	142.9/135.2	175/175	354.6/343.2	175/150	148.4/135.2	175/175	361.9/343.2	175/150	—	—
	575-60	518	633	114.6/110.2	125/125	283.4/277.8	125/125	115.7/110.2	125/125	286.3/277.8	125/125	120.5/110.2	150/125	292.1/277.8	150/125	—	—
130	208/230-60	187	253	423.7/243.8	500/300	869.6/635.0	450/300	426.7/243.8	500/300	877.6/635.0	500/300	438.4/243.8	500/300	893.7/635.0	500/300	—	—
	380-60	342	418	224.8/124.8	250/150	479.9/336.8	250/150	226.5/124.8	250/150	484.3/336.8	250/150	233.5/124.8	250/150	493.1/336.8	250/150	—	—
	460-60	414	506	188.5/106.3	225/125	398.0/280.4	200/125	189.9/106.3	225/125	401.6/280.4	225/125	195.4/106.3	225/125	408.9/280.4	225/125	—	—
	575-60	518	633	152.8/ 85.2	175/110	321.6/227.4	175/100	153.9/ 85.2	175/110	324.5/227.4	175/100	158.7/ 85.2	175/110	330.4/227.4	175/100	—	—
150	208/230-60	187	253	423.7/306.2	500/400	869.6/748.4	450/350	426.7/306.2	500/400	877.6/748.4	500/350	438.4/306.2	500/400	893.7/748.4	500/350	—	—
	380-60	342	418	224.8/160.2	250/200	479.9/413.6	250/175	226.5/160.2	250/200	484.3/413.6	250/175	233.5/160.2	250/200	493.1/413.6	250/175	—	—
	460-60	414	506	188.5/135.2	225/175	398.0/343.2	200/150	189.9/135.2	225/175	401.6/343.2	225/150	195.4/135.2	225/175	408.9/343.2	225/150	—	—
	575-60	518	633	152.8/110.2	175/125	321.6/277.8	175/125	153.9/110.2	175/125	324.5/277.8	175/125	158.7/110.2	175/125	330.4/277.8	175/125	—	—
160	208/230-60	187	253	541.8/243.8	600/300	987.7/635.0	600/300	544.8/243.8	600/300	995.6/635.0	600/300	556.5/243.8	600/300	1011.8/635.0	600/300	—	—
	380-60	342	418	287.2/124.8	300/150	542.3/336.8	300/150	288.9/124.8	300/150	546.7/336.8	300/150	295.9/124.8	300/150	555.5/336.8	350/150	—	—
	460-60	414	506	240.9/106.3	250/125	450.4/280.4	250/125	242.3/106.3	250/125	454.0/280.4	250/125	247.8/106.3	250/125	461.3/280.4	300/125	—	—
	575-60	518	633	195.4/ 85.2	225/110	364.2/227.4	225/100	196.5/ 85.2	225/110	367.1/227.4	225/100	201.3/ 85.2	225/110	372.9/227.4	225/100	—	—
170	208/230-60	187	253	541.8/306.2	600/400	987.7/748.4	600/350	544.8/306.2	600/400	995.6/748.4	600/350	556.5/306.2	600/400	1011.8/748.4	600/350	—	—
	380-60	342	418	287.2/160.2	300/200	542.3/413.6	300/175	288.9/160.2	300/200	546.7/413.6	300/175	295.9/160.2	350/200	555.5/413.6	300/175	—	—
	460-60	414	506	240.9/135.2	250/175	450.4/343.2	250/150	242.3/135.2	250/175	454.0/343.2	250/150	247.8/135.2	250/175	461.3/343.2	300/150	—	—
	575-60	518	633	195.4/110.2	225/125	364.2/277.8	225/125	196.5/110.2	225/125	367.1/277.8	225/125	201.3/110.2	225/125	372.9/277.8	225/125	—	—
190	208/230-60	187	253	565.7/400.4	600/450	1011.6/842.6	600/450	568.7/400.4	600/450	1019.5/842.6	600/450	580.4/400.4	600/450	1035.7/842.6	600/450	—	—
	380-60	342	418	300.3/209.5	350/250	555.4/462.9	350/225	302.0/209.5	350/250	559.7/462.9	350/225	309.0/209.5	350/250	568.6/462.9	350/225	—	—
	460-60	414	506	251.7/176.8	300/200	461.2/384.8	300/200	253.1/176.8	300/200	464.8/384.8	300/200	258.6/176.8	300/200	472.1/384.8	300/200	—	—
	575-60	518	633	204.0/144.1	225/175	372.8/311.7	225/175	205.1/144.1	225/175	375.7/311.7	225/175	209.9/144.1	225/175	381.5/311.7	225/175	—	—

### LEGEND

**ICF** — Instantaneous Current Flow (Ckt1/Ckt2) **MOCP** — Maximum Overcurrent Protection (Ckt1/Ckt2)  
**MCA** — Minimum Circuit Amps (Ckt1/Ckt2) **XL** — Across-the-Line Start

### NOTES:

- Units are suitable for use on electrical systems where voltage supplied to the unit terminals is not below or above the listed minimum and maximum limits. Maximum allowable phase imbalance is: voltage, 2%; amps 10%.
- Control power is derived from main power. No separate control power connection is required.
- Cooler heater is wired into the control circuit so it is always operable as long as the power supply disconnect is on, even if any safety device is open.
- For MCA that is less than or equal to 380 amps, 3 conductors are required.  
 For MCA between 381 and 760 amps, 6 conductors are required.  
 For MCA between 761 and 1140 amps, 9 conductors are required.  
 For MCA between 1141 and 1520 amps, 12 conductors are required.  
 Calculation of conductors required is based on 75 C copper wire.

- Wiring for main field supply must be rated 75 C minimum. Use copper for all units.
  - Incoming wire size range for the terminal block is no. 4 AWG (American Wire Gauge) to 500 kcmil.
  - Incoming wire size range of non-fused disconnect with MCA up to 599.9 amps is 3/0 to 500 kcmil.
  - Incoming wire size range of non-fused disconnect with MCA from 600 to 799.9 amps is 1/0 to 500 kcmil.
  - Incoming wire size range of non-fused disconnect with MCA from 800 to 1199.9 amps is 250 kcmil to 500 kcmil.
- Hydronic pump packages are not available as a factory-installed option for units 30RB210-300.
- Power draw includes both crankcase heaters and cooler heaters (where used). Each compressor has a crankcase heater which draws 56 watts of power. Units ordered with the cooler heater option have 1 (060-150) or 2 (

### 30RB210-300 ELECTRICAL DATA — DUAL POINT UNITS

30RB UNIT SIZE	UNIT VOLTAGE			NO HYDRONIC PACKAGE			
	V-Hz (3 Ph)	Supplied		MCA	MOCP	ICF	Rec Fuse Size
		Min	Max	XL	XL	XL	
210	208/230-60	187	253	626.7/353.9	700/400	1068.9/796.2	700/400
	380-60	342	418	327.7/186.4	350/225	581.1/439.7	350/200
	460-60	414	506	233.3/200.0	250/225	441.3/408.0	250/225
	575-60	518	633	188.8/162.0	200/175	356.4/329.6	200/175
225	208/230-60	187	253	684.3/353.9	700/400	1126.5/796.2	700/400
	380-60	342	418	360.4/186.4	400/225	613.8/439.7	400/200
	460-60	414	506	260.0/200.0	300/225	468.0/408.0	300/225
	575-60	518	633	211.9/162.0	225/175	379.5/329.6	225/175
250	208/230-60	187	253	684.3/472.0	700/500	1126.5/914.3	700/500
	380-60	342	418	360.4/248.7	400/250	613.8/502.1	400/250
	460-60	414	506	303.2/209.2	350/250	511.2/417.2	350/225
	575-60	518	633	246.4/170.0	250/200	414.1/337.6	250/200
275	208/230-60	187	253	920.5/353.9	1000/400	1362.7/796.2	1000/400
	380-60	342	418	485.2/186.4	500/225	738.5/439.7	500/200
	460-60	414	506	408.0/156.8	450/175	616.0/364.8	450/175
	575-60	518	633	331.5/127.5	350/150	499.1/295.1	350/150
300	208/230-60	187	253	920.5/472.0	1000/500	1362.7/914.3	1000/500
	380-60	342	418	485.2/248.7	500/250	738.5/502.1	500/250
	460-60	414	506	408.0/209.2	450/250	616.0/417.2	450/225
	575-60	518	633	331.5/170.0	350/200	499.1/337.6	350/200

**LEGEND**

**ICF** — Instantaneous Current Flow (Ckt1/Ckt2)  
**MCA** — Minimum Circuit Amps (Ckt1/Ckt2)  
**MOCP** — Maximum Overcurrent Protection (Ckt1/Ckt2)  
**XL** — Across-the-Line Start

**NOTES:**

- Units are suitable for use on electrical systems where voltage supplied to the unit terminals is not below or above the listed minimum and maximum limits. Maximum allowable phase imbalance is: voltage, 2%; amps 10%.
- Control power is derived from main power. No separate control power connection is required.
- Cooler heater is wired into the control circuit so it is always operable as long as the power supply disconnect is on, even if any safety device is open.
- For MCA that is less than or equal to 380 amps, 3 conductors are required.  
 For MCA between 381 and 760 amps, 6 conductors are required.  
 For MCA between 761 and 1140 amps, 9 conductors are required.  
 For MCA between 1141 and 1520 amps, 12 conductors are required.  
 Calculation of conductors required is based on 75 C copper wire.

- Wiring for main field supply must be rated 75 C minimum. Use copper for all units.
  - Incoming wire size range for the terminal block is no. 4 AWG (American Wire Gage) to 500 kcmil.
  - Incoming wire size range of non-fused disconnect with MCA up to 599.9 amps is 3/0 to 500 kcmil.
  - Incoming wire size range of non-fused disconnect with MCA from 600 to 799.9 amps is 1/0 to 500 kcmil.
  - Incoming wire size range of non-fused disconnect with MCA from 800 to 1199.9 amps is 250 kcmil to 500 kcmil.
- Hydronic pump packages are not available as a factory-installed option for units 30RB210-300.
- Power draw includes both crankcase heaters and cooler heaters (where used). Each compressor has a crankcase heater which draws 56 watts of power. Units ordered with the cooler heater option have 1 (060-150) or 2 (160-300) cooler heaters, 825 watts each.
- 30RB chillers with Greenspeed® technology are not available in size 060 and 070.



# IEECSA

## AIRE ACONDICIONADO

## 30RB ELECTRICAL DATA — POWER ENTRY

30RB UNIT SIZE	VOLTAGE	ELECTRICAL OPTION	CONNECTIONS	MAIN POWER ENTRANCE	CONTROL BOX		
060,070	208/230, 380, 460, 575	Standard (Terminal Block)	Single Point	Circuit 1	Combination		
			Dual Point	Circuit 1	Combination		
		Non-Fused Disconnect Option*	Single Point	Circuit 2	Combination		
080-120	208/230	Standard (Terminal Block)	Single Point	Circuit 1	Power-L		
			Dual Point	Circuit 1	Power-L		
		Non-Fused Disconnect Option*	Single Point	Circuit 2	Power-L		
	380, 460, 575	Standard (Terminal Block)	Single Point	Circuit 1	Combination		
			Dual Point	Circuit 1	Combination		
		Non-Fused Disconnect Option*	Single Point	Circuit 2	Combination		
130-190	208/230	Standard (Terminal Block)	Single Point	Circuit 1	Power-L		
			Dual Point	Circuit 1	Power-L		
		Non-Fused Disconnect Option	Single Point	Circuit 2	PEB1		
			Dual Point	Circuit 1	Power-L		
		380, 460, 575	Standard (Terminal Block)	Single Point	Circuit 1	Power-L	
				Dual Point	Circuit 1	PEB1	
	Non-Fused Disconnect Option		Single Point	Circuit 2	PEB1		
			Dual Point	Circuit 1	PEB1		
	210, 225		208/230†	Standard (Terminal Block)	Single Point	Circuit 1	Power-L
					Dual Point	Circuit 1	Power-L
		Non-Fused Disconnect Option		Dual Point	Circuit 2	PEB2	
		380, 460, 575	Standard (Terminal Block)	Single Point	Circuit 1	PEB1	
Dual Point				Circuit 1	PEB1		
Non-Fused Disconnect Option			Dual Point	Circuit 2	PEB1		
250-300	208/230†	Standard (Terminal Block)	Single Point	Circuit 1	Power-L		
			Dual Point	Circuit 1	Power-L		
		Non-Fused Disconnect Option	Dual Point	Circuit 2	PEB2		
	380, 460, 575	Standard (Terminal Block)	Single Point	Circuit 1	PEB1		
			Dual Point	Circuit 1	PEB1		
		Non-Fused Disconnect	Single Point	Circuit 2	PEB2		

LEGEND

PEB — Power Electrical Box

\*Dual point connection is not available when non-fused disconnect option is selected.

†Single point connection not available.

NOTE: 30RB chillers with Greenspeed® technology are not available in size 060



### CONDENSER FAN ELECTRICAL DATA

30RB UNIT SIZE	UNIT VOLTAGE V-Hz (3 Ph)	STANDARD CONDENSER FANS					
		Circuit A Quantity	FLA (each)	Circuit B Quantity	FLA (each)	Circuit C Quantity	FLA (each)
060, 070	208/230-60	3	11.9	1	11.9	—	—
	380-60	3	6.5	1	6.5	—	—
	460-60	3	5.4	1	5.4	—	—
	575-60	3	4.3	1	4.3	—	—
080	208/230-60	2	11.9	2	11.9	—	—
	380-60	2	6.5	2	6.5	—	—
	460-60	2	5.4	2	5.4	—	—
	575-60	2	4.3	2	4.3	—	—
090, 100, 110	208/230-60	3	11.9	3	11.9	—	—
	380-60	3	6.5	3	6.5	—	—
	460-60	3	5.4	3	5.4	—	—
	575-60	3	4.3	3	4.3	—	—
120	208/230-60	3	11.9	4	11.9	—	—
	380-60	3	6.5	4	6.5	—	—
	460-60	3	5.4	4	5.4	—	—
	575-60	3	4.3	4	4.3	—	—
130, 150	208/230-60	4	11.9	4	11.9	—	—
	380-60	4	6.5	4	6.5	—	—
	460-60	4	5.4	4	5.4	—	—
	575-60	4	4.3	4	4.3	—	—
160,170	208/230-60	6	11.9	4	11.9	—	—
	380-60	6	6.5	4	6.5	—	—
	460-60	6	5.4	4	5.4	—	—
	575-60	6	4.3	4	4.3	—	—
190	208/230-60	6	11.9	6	11.9	—	—
	380-60	6	6.5	6	6.5	—	—
	460-60	6	5.4	6	5.4	—	—
	575-60	6	4.3	6	4.3	—	—
210, 225	208/230-60	4	11.9	4	11.9	4	11.9
	380-60	4	6.5	4	6.5	4	6.5
	460-60	4	5.4	4	5.4	4	5.4
	575-60	4	4.3	4	4.3	4	4.3
250	208/230-60	4	11.9	4	11.9	6	11.9
	380-60	4	6.5	4	6.5	6	6.5
	460-60	4	5.4	4	5.4	6	5.4
	575-60	4	4.3	4	4.3	6	4.3
275	208/230-60	6	11.9	6	11.9	4	11.9
	380-60	6	6.5	6	6.5	4	6.5
	460-60	6	5.4	6	5.4	4	5.4
	575-60	6	4.3	6	4.3	4	4.3
300	208/230-60	6	11.9	6	11.9	6	11.9
	380-60	6	6.5	6	6.5	6	6.5
	460-60	6	5.4	6	5.4	6	5.4
	575-60	6	4.3	6	4.3	6	4.3

LEGEND  
FLA — Full Load Amps

NOTE: 30RB chillers with Greenspeed® technology are not available in size 060 and 070.

### PUMP ELECTRICAL DATA

PUMP HP	UNIT VOLTAGE V-Hz (3 Ph)	HYDRONIC SYSTEM (SINGLE/DUAL) FLA (each)	USED ON 30RB SIZES*
3	208/230-60	9.1	060, 070
	380-60	5.1	
	460-60	4.2	
	575-60	3.3	
5	208/230-60	15.4	060-190
	380-60	8.1	
	460-60	7.1	
	575-60	5.4	
7.5	208/230-60	22.0	060-190
	380-60	12.3	
	460-60	10.1	
	575-60	8.1	
10	208/230-60	25.0	060-190
	380-60	14.0	
	460-60	11.5	
	575-60	9.2	
15	208/230-60	36.7	080-190
	380-60	21.0	
	460-60	17.0	
	575-60	14.0	

LEGEND  
FLA — Full Load Amps  
\*Hydronic pump packages are not available as a factory-installed option for units 30RB210-300.

NOTE: 30RB chillers with Greenspeed® technology are not available in size 060 and 070.



## Microprocessor

The *ComfortLink* microprocessor controls overall unit operation. Its central executive routine controls a number of processes simultaneously. These include internal timers, reading inputs, analog to digital conversions, fan control, display control, diagnostic control, output relay control, demand limit, capacity control, head pressure control, and temperature reset. Some processes are updated almost continuously, others every 2 to 3 seconds, and some every 30 seconds. The microprocessor routine is started by switching the Emergency ON-OFF switch to ON position. Pump control of external pumps (where so configured) or optional internal pump, will energize the cooler pump to the internal (or CCN) time schedule (or input occupied signal from external system).

Where dual pumps are utilized only one pump will be operated at a time. The control will start the pump with the least hours. When the unit receives a call for cooling (based on a deviation from chilled water set point), the unit stages up in capacity to maintain the cooler fluid set point. The first compressor starts 1 to 3 minutes after the call for cooling. The *ComfortLink* microprocessor controls the capacity of the chiller by cycling compressors at a rate to satisfy actual dynamic load conditions. The control maintains leaving-fluid temperature set point shown on the scrolling marquee display board through intelligent cycling. Accuracy depends on loop volume, loop flow rate, load, outdoor-air temperature, number of stages, and particular stage being cycled off. No adjustment for cooling range or cooler flow rate is required, because the control automatically compensates for cooling range by measuring both return-fluid temperature and leaving-fluid temperature. This is referred to as leaving-fluid temperature control with return-fluid temperature compensation.

The basic logic for determining when to add or remove a stage is a time band integration of deviation from set point plus rate of change of leaving-fluid temperature. When leaving-fluid temperature is close to set point and slowly moving closer, logic prevents addition of another stage.

If 1°F per minute (0.6°C per minute) pulldown control has been selected (adjustable setting), no additional steps of capacity are added as long as the difference between leaving-fluid temperature and set point is greater than 4°F (2.2°C) and rate of change in leaving-fluid temperature is greater than the selected pulldown control rate. If it has been less than 90 seconds since the last capacity change, compressors will continue to run unless a safety device trips. This prevents rapid cycling and also helps return oil during short on periods.

## Sensors

Thermistors are used to control temperature-sensing inputs to microprocessor. Additional thermistor sensors may be used as remote temperature sensors for optional LCWT (leaving chilled fluid temperature) reset.

- Cooler leaving chilled fluid temperature (T1)
- Cooler entering fluid (return) temperature (T2)
- Outside-air temperature (T9)

Two refrigerant pressure transducers are used in each circuit for sensing suction and discharge pressure. The microprocessor uses these inputs to control capacity and fan cycling.

- Saturated condensing temperature
- Cooler saturation temperature

## Control sequence

### Off cycle

If ambient temperature is below 36°F (2°C), cooler heaters (if equipped) are also energized.

### Start-up

After the control circuit switches on, the prestart process takes place, then microprocessor checks itself, starts pump (if configured) and waits for temperature to stabilize. The controlled pulldown feature limits compressor loading on start-up to reduce demand on start-up and unnecessary compressor usage. The microprocessor limits supply-fluid temperature decrease (start-up only) to 1°F (0.6°C) per minute.

### Capacity control

On first call for cooling, microprocessor starts initial compressor and fan stage on lead circuit.

As additional cooling is required, additional compressors are energized.

Speed at which capacity is added or reduced is controlled by temperature deviation from set point and rate of temperature change of chilled fluid.

The Main Base Board (MBB) responds to the supply chilled water temperature to cycle the compressors to match cooling load requirements.

Minimum load control valve is energized by the MBB. Valve allows hot gas to pass directly into the cooler circuit on the final step of unloading, permitting the unit to operate at lower loads with less compressor cycling.

### Additional information

Detailed information on controls and operation is available in the Controls, Start-Up, Operation and Troubleshooting guide included with each unit. Packaged Service Training programs are also available. Contact your Carrier representative for more information.

### High-efficiency variable condenser fans (30RB chillers with Greenspeed® intelligence only)

All fans on a circuit run at the same speed and are controlled by a VFD with special CCN software to maintain SCT (saturated condensing temperature) set point. The set point is calculated from operating conditions and adjusted to the most efficient operating point. The high-efficiency variable condenser fan option uses Danfoss VLT 102 variable frequency drives, each with a display. Drives are connected to the LEN communication bus. Fan speed is determined by the chiller controller and communicated to the drive to provide excellent part load efficiency and reduced sound level operation over the life of the chiller.

### Dual chiller control

The *ComfortLink* controller allows 2 chillers (piped in parallel) to operate as a single chilled water plant with standard control functions coordinated through the master chiller controller. This standard *ComfortLink* feature requires a communication link between the 2 chillers and, in the case of parallel chillers, requires an additional thermistor and well for each chiller.

## Dynamic ComfortLink controls

Dynamic *ComfortLink* controls keep the chiller on line during periods of extreme operating conditions. If the entering fluid temperature is 85°F (29°C) or higher and the saturated suction temperature is 50°F (10°C) or higher the maximum operating pressure (MOP) feature limits the suction to keep the chiller online. The control automatically starts the chiller in the unloaded state to eliminate the potential of compressor overload due to high head pressure or low suction pressure. The controller will equalize run time on each circuit through the lead/lag feature. If a circuit becomes disabled, the control will automatically set the active circuit to lead, keeping the chiller online at a reduced capacity.

### CAPACITY CONTROL STEPS\*

UNIT 30RB	STANDARD CAPACITY STEPS (%)
060	0, 33, 67, 100
070	0, 29, 64, 100
080	0, 25, 50, 75, 100
090	0, 22, 50, 72, 100
100	0, 25, 50, 75, 100
110	0, 18, 41, 59, 82, 100
120	0, 20, 40, 60, 80, 100
130	0, 15, 33, 48, 67, 81, 100
150	0, 17, 33, 50, 67, 83, 100
160	0, 13, 28, 41, 56, 69, 84, 100
170	0, 14, 29, 43, 57, 71, 86, 100
190	0, 13, 25, 38, 50, 63, 75, 88, 100
210	0, 10, 21, 33, 43, 55, 67, 76, 88, 100
225	0, 11, 22, 33, 44, 56, 67, 78, 89, 100
250	0, 10, 20, 30, 40, 50, 60, 70, 80, 90, 100
275	0, 9, 18, 27, 36, 45, 55, 64, 73, 82, 91, 100
300	0, 8, 17, 25, 33, 42, 50, 58, 67, 75, 83, 92, 100

\*Capacity control steps may vary due to compressor sequencing.

## Standard ComfortLink controls with scrolling marquee display

A four-digit alphanumeric display shows all of the *ComfortLink* control codes (with 60-character expandable clear language), plus set points, time of day, temperatures, pressures, and superheat. Additional information can be displayed all at once with the accessory Navigator™ display.

### Navigator display

An optional 4-line, 20-character per line display and also available as a field-installed accessory.

### Low-temperature override

This feature prevents LCWT from overshooting the set point and possibly causing a nuisance trip-out by the freeze protection.

### High-temperature override

This feature allows chiller to add capacity quickly during rapid load variations.

### Abnormal conditions

All control safeties in chiller operate through compressor protection board or control relay and microprocessor.

Loss of feedback signal to the MBB will cause the compressor(s) to shut down. For other safeties, microprocessor makes appropriate decision to shut down a compressor due to a safety trip or bad sensor reading and displays appropriate failure code on the display. Chiller remains in safety mode until reset. It then reverts to normal control when unit is reset.

## Low-pressure safety

Safety cuts out if system pressure drops below minimum.

## High-pressure cutout

Switch shuts down compressors if compressor discharge pressure increases to 641 psig (4420 kPa).

## Compressor anti-cycling

This feature limits compressor cycling.

## Loss of flow protection

Proof of flow switches are standard and installed on all 30RB chillers.

## Sensor failures

Failures are detected by the microprocessor.

### Temperature reset

The energy management module (EMM) is required for 4 to 20 mA reset of LCWT in constant fluid systems. Reset by return fluid, outdoor-air temperature, or space temperature does not require this option. Reset reduces compressor power usage at part load when design LCWT is not necessary. Humidity control should be considered since higher coil temperatures resulting from reset will reduce latent heat capacity. Three reset options are offered, based on the following:

### Return-fluid temperature

Increases LCWT set point as return (or entering) fluid temperature decreases (indicating load decrease). Option may be used in any application where return fluid provides accurate load indication. Limitation of return fluid reset is that LCWT may only be reset to value of design return fluid temperature.

### Outdoor-air temperature

Increases LCWT as outdoor ambient temperature decreases (indicating load decrease). This reset should be applied only where outdoor ambient temperature is an accurate indication of load. An accessory thermistor is required.

### Space temperature

Increases LCWT as space temperature decreases (indicating load decrease). This reset should be applied only where space temperature is an accurate indication of load. An accessory thermistor and the energy management module accessory is required.

For details on applying a reset option, refer to unit Controls and Troubleshooting literature. Obtain ordering part numbers for reset option from the Packaged Chiller Builder program or contact your local Carrier representative.

## Accessory controls

Demand can be limited by controlling the chiller capacity through the demand limit control (the energy management module is required for this function). This factory-installed option or accessory interfaces with microprocessor to control unit so that chiller's kW demand does not exceed its setting. It is activated from an external switch or a 4 to 20 mA signal.

The standard *ComfortLink* controller is programmed to accept various accessory temperature reset options (based on outdoor-air temperature [standard], return-fluid temperature, or space temperature), that reset the LCWT. An accessory thermistor (T10) is required if outdoor-air temperature or space temperature reset is selected. The



energy management module (EMM) is only required for temperature reset that is initiated by a 4 to 20 mA signal.

#### **Demand limit**

If applied, this limits the total power draw of unit to selected point by controlling number of operational compressors during periods of peak electrical demand. The energy management module is required for either 2-step or 4 to 20 mA demand limit.

#### **Electronic expansion valve (EXV)**

The EXV controls refrigerant flow to the cooler for different operating conditions by moving an orifice to increase or decrease the flow area through the valve based on microprocessor input. The orifice is positioned by a stepper motor through approximately 3,600 discrete steps and is monitored every three seconds. The EXV maintains an approximate 8°F (5°C) refrigerant superheat entering the compressor.

#### **Diagnostics**

The microprocessor may be put through a service test (see Controls, Start-Up, Operation, Service, and Troubleshooting literature). Service test confirms microprocessor is functional, informs observer through display the condition of each sensor and switch in chiller, and allows observer to check for proper operation of fans and compressors.

#### **Default settings**

To facilitate quick start-ups, 30RB chillers with *ComfortLink* controls are pre-configured with a default setting that assumes stand-alone operation supplying 44°F (6.7°C) chilled water.

Configuration settings will be based on any options or accessories included with the unit at the time of manufacturing.

Date and time are set to U.S.A. Eastern Time zone and will need reconfiguring based on location and local time zone. If operation based on occupancy scheduling is desired, this will also need to be set during installation.

#### **Ice duty**

*ComfortLink* controls have the capability of reduced leaving fluid temperature operation for thermal storage, or ice duty. On unit sizes 060-100 the optional energy management module includes input contacts for the “ice done” signal generated by the thermal storage control system. The ice duty feature may be configured to start on an external input command or by the *ComfortLink* standard internal scheduling function. Ice duty may be used in combination with any other standard features offered by the energy management module and *ComfortLink* controls.

The production of ice, which is stored for peak cooling demands, can significantly decrease energy costs. The unit produces ice (normally at night) by supplying ice storage tanks with low temperature cooling fluid. The chiller takes advantage of reduced ambient conditions at night for ice-making mode, so the capacity suffers a lower penalty for the low leaving fluid temperatures.

At peak cooling demands the chiller and the stored ice may share the cooling load to reduce operating costs. The thermal storage system may potentially reduce the size of the chiller plant required to meet demand loads.

**IEEGCSA**  
AIRE ACONDICIONADO

# Typical control wiring schematic



- NOTES:**
1. FACTORY WIRING IS IN ACCORDANCE WITH UL 1995 STANDARDS. FIELD MODIFICATIONS OR ADDITIONS MUST BE IN COMPLIANCE WITH ALL APPLICABLE CODES.
  2. WIRING FOR MAIN FIELD SUPPLY MUST BE RATED 75C MINIMUM. USE COPPER FOR ALL UNITS. INCOMING WIRE SIZE RANGE OF NON-FUSED DISCONNECT WITH MCA UP TO 599.9 AMPS IS 3/0 TO 500 KCMIL. INCOMING WIRE SIZE RANGE OF NON-FUSED DISCONNECT WITH MCA FROM 600 TO 799.9 AMPS IS 1/0 TO 500 KCMIL. INCOMING WIRE SIZE RANGE OF NON-FUSED DISCONNECT WITH MCA FROM 800 TO 1199.9 AMPS IS 250 KCMIL TO 500 KCMIL. THE CONTACTS MUST BE RATED FOR FIELD EXTERNAL CONNECTIONS FOR REMOTE ON-OFF. 24VAC LOAD UP TO 50 MA.
  3. THE CONTACTS MUST BE RATED FOR DRY CIRCUIT APPLICATION CAPABLE OF HANDLING A 24VAC LOAD UP TO 50 MA.
  4. TERMINALS 1 AND 2 OF TB5 ARE FOR EXTERNAL CONNECTIONS OF CHILLED WATER PUMP INTERLOCK. THE CONTACTS MUST BE RATED FOR DRY CIRCUIT APPLICATION CAPABLE OF HANDLING A 24VAC LOAD UP TO 50 MA.
  5. TERMINALS 13 AND 14 OF TB5 ARE FOR CONTROL OF CHILLED WATER PUMP (PMP1) STARTER. THE MAXIMUM LOAD ALLOWED FOR THE CHILLED WATER PUMP RELAY IS 5 VA SEALED, 10 VA UNSEALED AT 24V. FIELD POWER SUPPLY IS NOT REQUIRED.
  6. TERMINALS 15 AND 16 OF TB5 ARE FOR CONTROL OF CHILLED WATER PUMP (PMP2) STARTER. THE MAXIMUM LOAD ALLOWED FOR THE CHILLED WATER PUMP RELAY IS 5 VA SEALED, 10 VA UNSEALED AT 24V. FIELD POWER SUPPLY IS NOT REQUIRED.
  7. TERMINALS 12 AND 13 OF TB5 ARE FOR A ALARM RELAY. THE MAXIMUM LOAD ALLOWED FOR THE ALARM RELAY IS 5 VA SEALED, 10 VA UNSEALED AT 24V. FIELD POWER SUPPLY IS NOT REQUIRED.
  8. TERMINALS 17 AND 18 OF TB5 ARE FOR SHUTDOWN RELAY. THE MAXIMUM LOAD ALLOWED FOR THE SHUTDOWN RELAY IS 5 VA SEALED, 10 VA UNSEALED AT 24V. FIELD POWER SUPPLY IS NOT REQUIRED.
  9. J3 - 2A AND 25 OF EMM BOARD ARE FOR RUN RELAY AND SHUTDOWN RELAY. THE MAXIMUM FIELD POWER SUPPLY IS NOT REQUIRED.

- LEGEND:**
- A - ALARM
  - PMP1 - CHILLED WATER PUMP INTERLOCK
  - CMP - CHILLED WATER PUMP
  - EMM - ENERGY MANAGEMENT
  - SDR - SHUTDOWN RELAY
  - MV - MINIMUM LOAD VALVE
  - TB - TERMINAL BLOCK
  - ..... FIELD POWER WIRING
  - FACTORY INSTALLED WIRING

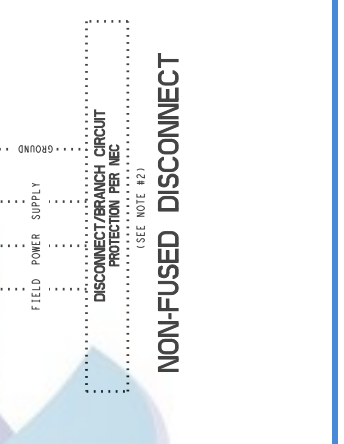
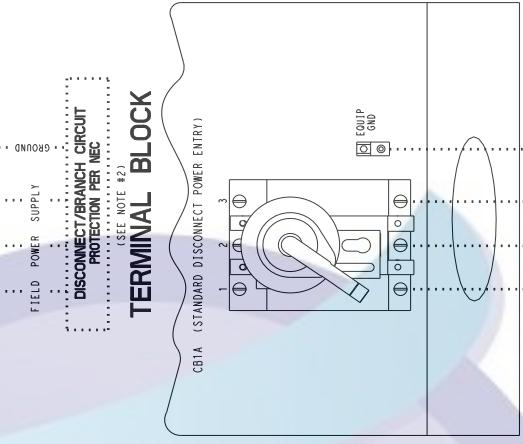
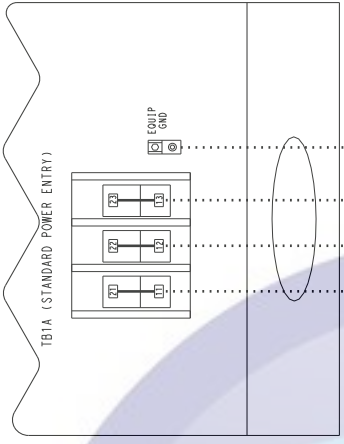
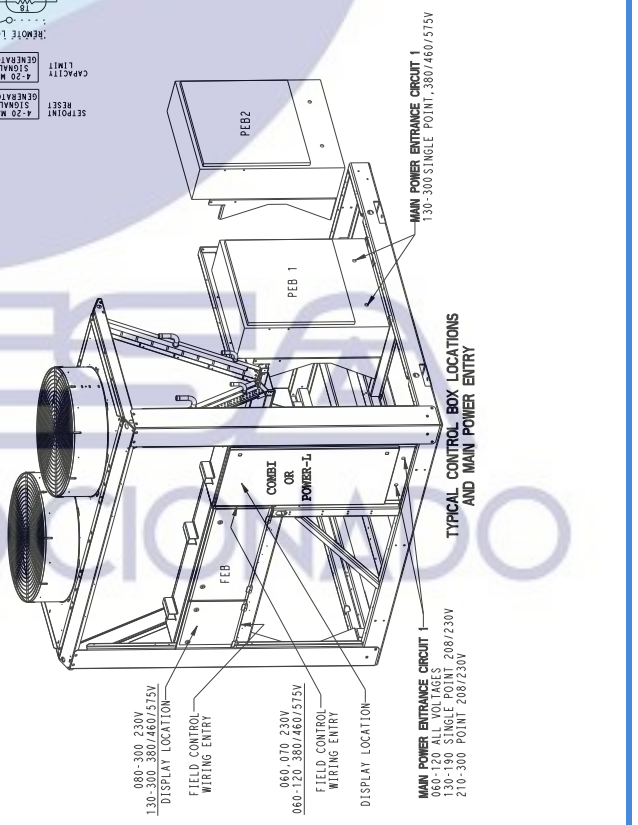
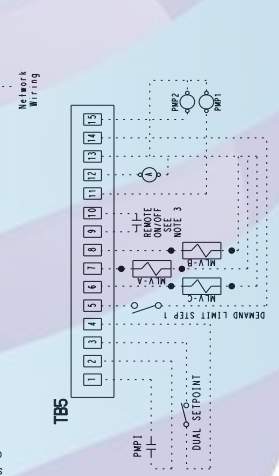
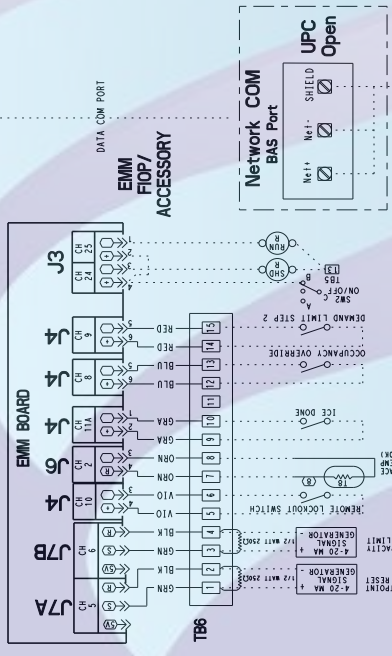
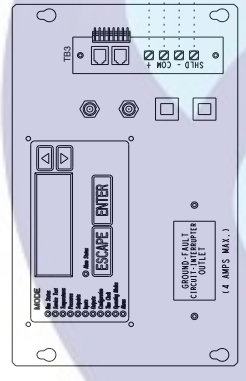
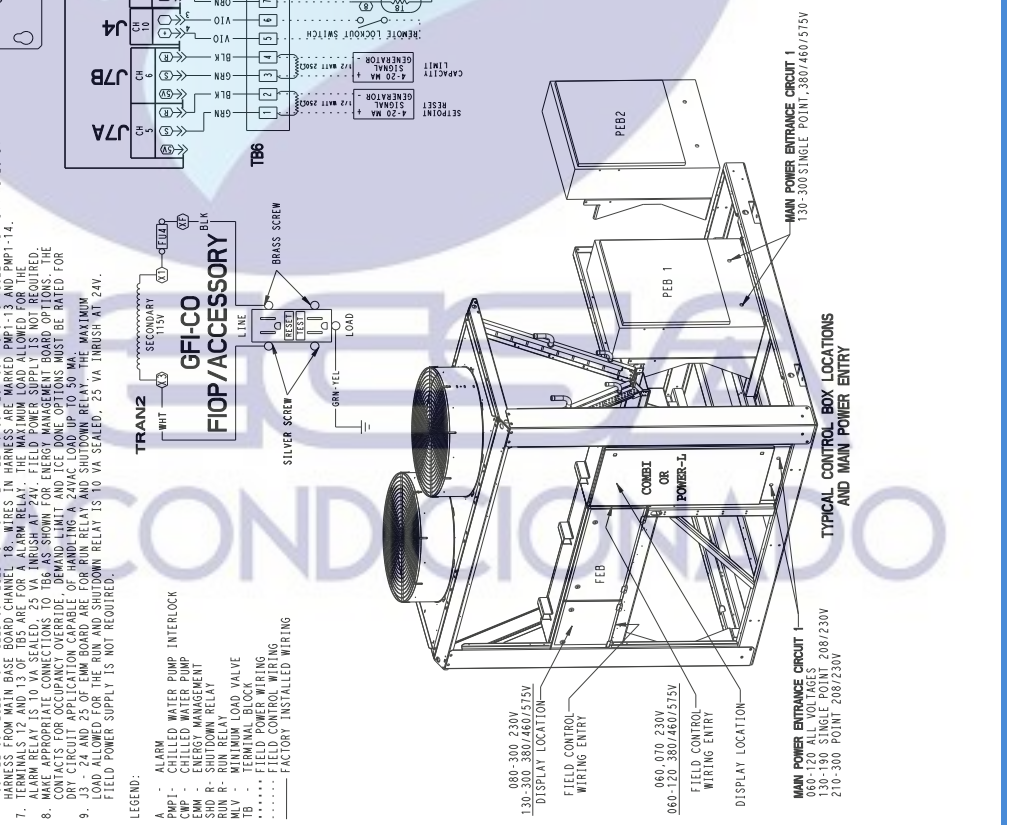

# Application data

## Chiller location and clearances

### The 30RB unit must be installed outdoors.

Do not locate near sound sensitive areas without proper acoustic consideration. For applications requiring mounting a chiller on a building rooftop, consideration should be given to using rubber-in-shear or spring isolators to minimize structure-borne transmission. Unit must be level when installed to ensure proper oil return to the compressors. Clearances must be provided around chillers for airflow, service and local code requirements. See dimensional drawings for specific unit clearance requirements. Ensure adequate clearance between adjacent chillers is maintained. A minimum of 10 ft (3048 mm) is recommended. Chiller fan is strongly recommended to be at least as high as adjacent solid walls. Installation in pits is not recommended.

### Minimum clearances

The recommended minimum clearance to ensure proper airflow through the condenser coils and to allow fan maintenance is as shown below.

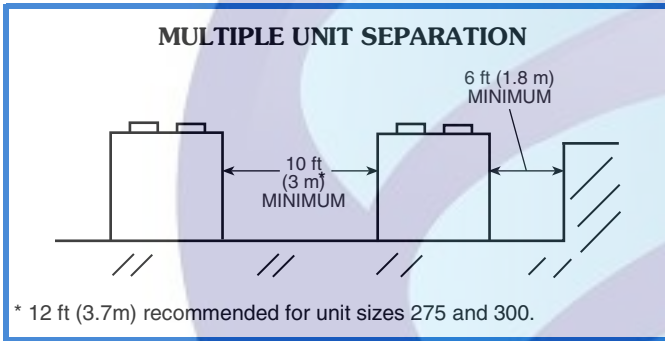

Acceptable clearance on the cooler connection side or end opposite the control box of the unit can be reduced to 3 ft (1 m) without sacrificing performance as long as the remaining three sides are unrestricted. Acceptable clearance on the side with a control box can be reduced to 4 ft (1.3 m) due to NEC (National Electric Code) regulations, without sacrificing performance as long as the remaining three sides are unrestricted. Clearances between chillers in dual chiller applications may be reduced to 6 ft (1.8 m) without sacrificing performance provided the remaining sides are unrestricted.

There are applications, however, in which recommended minimum clearances are not available. In these situations, customers request a prediction of the chiller performance within the confined space. A generalized derating factor may be insufficient to fully predict performance with various real-life physical layouts and ambient conditions.

To improve performance predictions when recommended clearances cannot be met, Carrier has developed the ExpertFit™ Software Model. An interface in the computerized chiller selection program predicts air-cooled chiller performance within a confined space, taking into account various spatial constraints and conditions, thus providing actual performance reports and not just derate guidelines.

Using this tool will provide the customer with a realistic expectation for their actual installation. The illustration below is an example of a typical installation that the software can model.

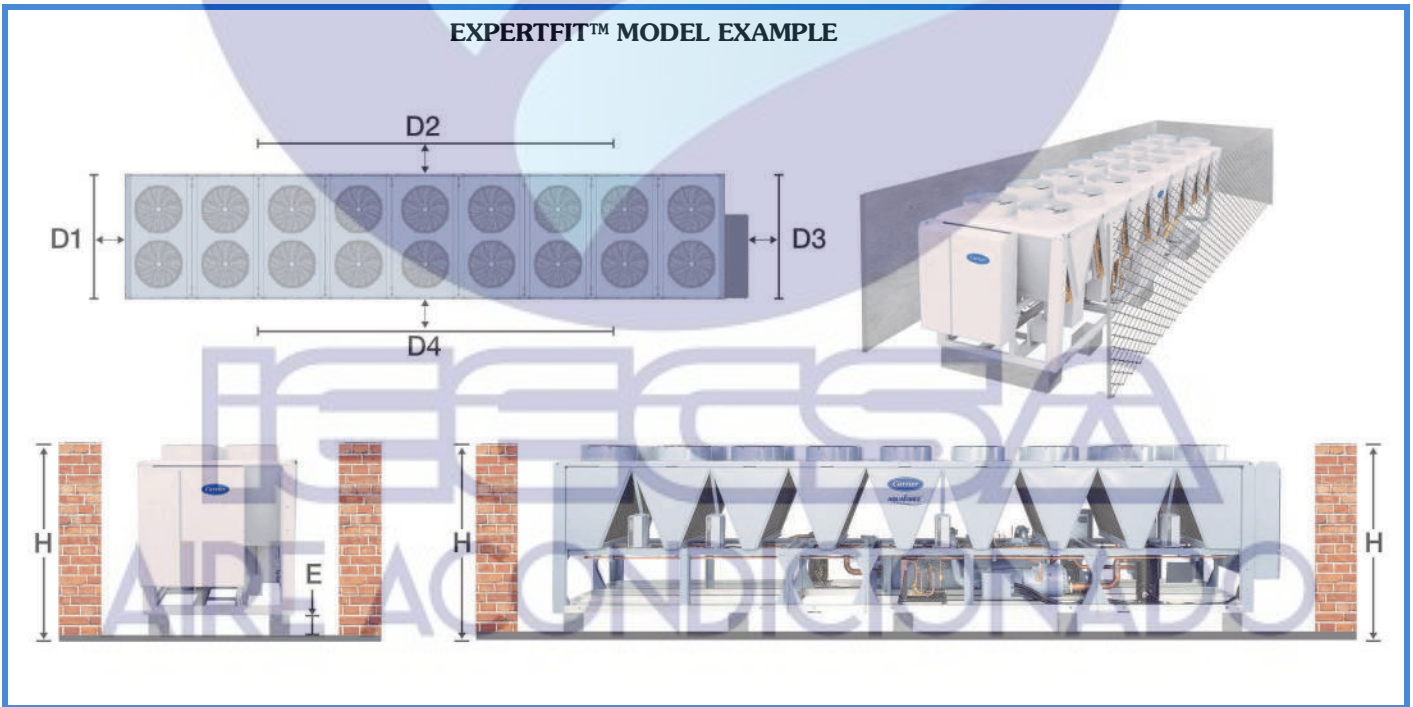

## Oversizing chillers

Oversizing chillers by more than 15% at design conditions must be avoided as the system operating efficiency is adversely affected (resulting in greater or excessive electrical demand). When future expansion of equipment is anticipated, install a single chiller to meet present load requirements and add a second chiller to meet the additional load demand. It is also recommended that 2 smaller chillers be installed where operation at minimum load is critical. The operation of a smaller chiller loaded to a greater percentage over minimum is preferred to operating a single chiller at or near its minimum recommended value. Minimum load control should not be used as a means to allow oversizing chillers. Minimum load control should be given consideration where substantial operating time is anticipated below the minimum unloading step.

## Piping duplex units

The 30RB duplex chillers (sizes 315 - 390) are shipped and rigged as 2 separate units. The units must be piped in parallel. If units are to be aligned end-to-end, minimum spacing of 42 to 48-in. (depending on local codes) between chillers is recommended to provide adequate service access and piping clearance.

## Multiple chillers

Where chiller capacities greater than can be supplied by a single 30RB chiller are required, or where standby capability is desired, chillers may be installed in parallel. Units may be of the same or different sizes with this piping arrangement. However, cooler flow rates must be balanced to ensure proper flow to each chiller.

Unit software is capable of controlling two parallel units as a single plant by making use of the dual chiller control feature. Refer to the Controls, Start-up, Operation, Service and Troubleshooting guide for further details. The accessory Chillervisor System Manager can be used to ensure proper staging sequence of up to 8 chillers arranged in a

parallel configuration. Refer to the accessory Chillervisor System Manager installation instructions for further details.

If the dual chiller algorithm is used, and the machines are installed in parallel, an additional chilled water sensor must be installed for each module. For 30RB315-390, where it is understood that these are duplex chillers comprised of 2 chillers to be installed in parallel, two factory-supplied thermistors and wells are shipped in the control box of one of the modules (for other 30RB chiller sizes which will be installed in a parallel piping configuration, a dual chiller accessory kit is available). Install one thermistor and well per chiller in the common leaving water header.

Parallel chiller control with dedicated pumps is recommended. The chiller must start and stop its own water pump located in its own piping. Check valves are required at the discharge of each pump (*when the factory hydronic package option is chosen, and dual pumps are selected, the check valves are automatically supplied*). If pumps are not dedicated for each chiller, then isolation valves are required. Each chiller must open and close its own isolation valve through the unit control (the valve must be connected to the pump outputs). Refer to the chiller piping configuration shown on the next page.

If a series application is required, the master/slave control feature cannot be used. Hydronic pump packages may not be applied in series applications.

## Series chillers

Where a large temperature drop (greater than 20°F [11.1°C]) is desired or where chiller capacities greater than can be supplied by a single 30RB chiller are required or where standby capability is required, chillers may be installed in series. The leaving fluid temperature sensors need not be relocated. However, the cooler minimum entering fluid temperature limitations should be considered for the chillers located downstream of other chillers. Use of reduced pass heads may be required to keep water-side pressure drop at an acceptable level.

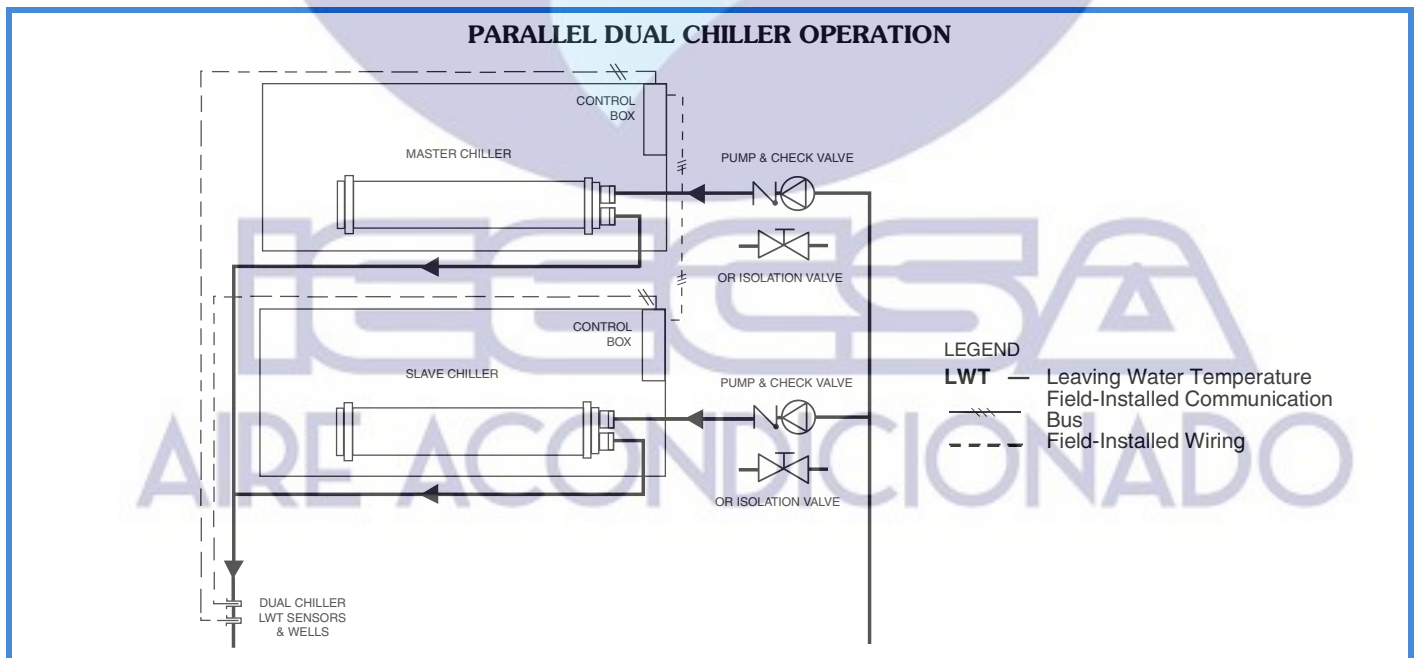

### Cooler water temperature

1. Maximum leaving chilled water temperature (LCWT) for the unit is 60°F (15.6°C). Unit can start and pull down with up to 95°F (35°C) entering-water temperature. It is recommended that entering-water temperature not exceed 70°F (21.1°C).
2. Minimum LCWT for standard unit is 30°F (-1.1°C). For leaving-fluid temperatures between 15 and 39.9°F (-9.4°C and 3.3°C) an inhibited antifreeze solution is required. Application of chiller to 15°F (-9.4°C) is standard on unit sizes 30RB060-100 provided that the unit is supplied with suction line insulation and low ambient head pressure control or optional 30RB chillers with Greenspeed® intelligence. For unit sizes 30RB110-390, applications with leaving fluid temperatures below 30°F (-1.1°C) are not available.

NOTE: Water flowing through cooler should not exceed 100°F (38°C).

### Strainers

For any application that does not have a factory-installed hydronic package, and for all open-loop applications, a screen strainer with a minimum screen size of 20 mesh must be installed a maximum of 10 ft (3.0 m) from the unit to prevent debris from damaging internal tubes of the cooler.

#### STRAINER REQUIREMENTS

APPLICATION	30RB WITH DX (SHELL-IN-TUBE) HEAT EXCHANGER	
	With Hydronic Package*	Without Hydronic Package
	Type of Strainer	
Closed Loop	1/8-in. Perforated (Factory Supplied)	20 Mesh†
Open Loop	1/8-in. Perforated (Factory Supplied) and 20 Mesh†	20 Mesh†

\* Units with a hydronic package are shipped with a fine mesh start-up strainer that must be removed within 24 hours after start-up.

† A 20-mesh strainer must be field supplied and installed within 10 ft (3 m) of the cooler inlet.

### Cooler flow/range

Ratings and performance data in this publication are for a cooling temperature rise of 10°F (6°C). The 30RB chillers may be operated at a different temperature rise, providing flow limits are not exceeded and corrections to system guidelines are made. For minimum and maximum cooler flow rates, see the Minimum and Maximum Cooler Flow Rates table on page 62. A high flow rate is generally limited by the maximum pressure drop that can be tolerated by the unit. The 30RB chillers are designed for a full load temperature rise of 3° to 20°F (1.7° to 11.1°C). Use the Packaged Chiller Builder Program to obtain the rating if a temperature rise other than 10°F (6°C) is used.

### Minimum cooler flow (maximum cooler temperature rise)

The minimum cooler flow for standard units is shown in Minimum and Maximum Cooler Fluid Flow Rates table on page 62. When system design conditions require a lower flow (or higher rise) than the minimum allowable cooler flow, follow the recommendations below.

- a. Multiple smaller chillers may be applied in series, each providing a portion of the design temperature rise.
- b. Cooler fluid may be recirculated to raise the flow rate to the chiller. The mixed temperature entering the cooler must be maintained to a minimum of at least 3°F (1.7°C) above the LCWT and to a maximum of no more than 20°F (11.1°C) above the LCWT.

NOTE: Recirculation flow is shown below.

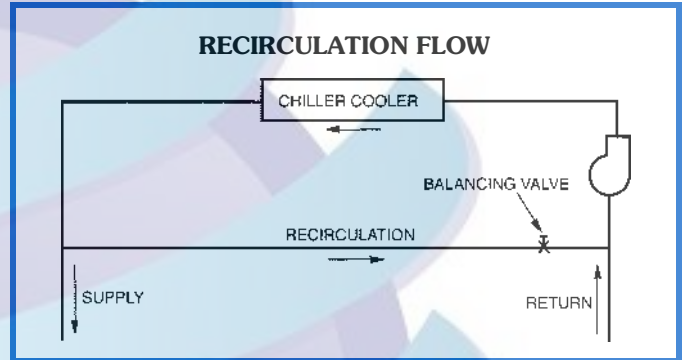

### Maximum cooler flow

The maximum cooler flow (see the Minimum and Maximum Cooler Flow Rates table on page 62) results in a practical maximum pressure drop through cooler.

Return fluid may bypass the cooler to keep the pressure drop through the cooler within acceptable limits. This permits a higher delta T with lower fluid flow through cooler and mixing after the cooler. The mixed temperature entering the cooler must be maintained to a minimum of at least 3°F (1.7°C) above the LCWT and to a maximum of no more than 20°F (11.1°C) above the LCWT.

NOTE: Bypass flow is shown below.

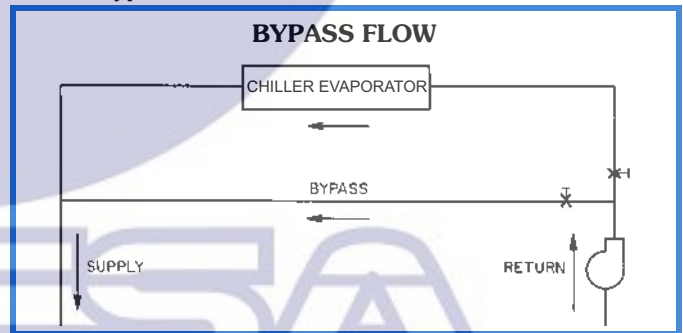

### Variable cooler flow rates

Variable flow rates may be applied to a standard chiller. The unit will, however, attempt to maintain a constant leaving chilled water temperature. In such cases, the minimum flow must be in excess of the minimum flow given in the Minimum and Maximum Cooler Fluid Flow Rates table (page 62), adjusted for glycol in the system, and the minimum fluid volume must be in excess of 3 gallons per ton (3.2 L per kW). The flow rate must change at a rate less than 10% per minute. Apply a minimum of 6 gallons per ton (6.5 L per kW) water loop volume if the flow rate changes more rapidly.

## MINIMUM AND MAXIMUM COOLER FLOW RATES 30RB060-300\*

30RB UNIT SIZE	MINIMUM COOLER FLOW RATE (gpm)†	MAXIMUM COOLER FLOW RATE (gpm)	MINIMUM LOOP VOLUME (gal.)	MINIMUM COOLER FLOW RATE (l/s)†	MAXIMUM COOLER FLOW RATE (l/s)	MINIMUM LOOP VOLUME (liters)
060	72	288	180	5	18	681
070	84	336	210	5	21	795
080	96	384	240	6	24	908
090	108	432	270	7	27	1022
100	120	480	300	8	30	1136
110	132	528	330	8	33	1249
120	144	576	360	9	36	1363
130	156	624	390	10	39	1476
150	180	720	450	11	45	1703
160	192	768	480	12	48	1817
170	204	816	510	13	51	1931
190	228	912	570	14	58	2158
210	252	950	630	16	60	2385
225	270	950	675	17	60	2555
250	300	950	750	19	60	2839
275	330	950	825	21	60	3123
300	360	950	900	23	60	3407

\* 30RB chillers with Greenspeed® intelligence are not available in size 060 and 070.

† For minimum cooler flow rate with brine applications, refer to E-cat software performance.

### Fluid loop volume

The volume in circulation must equal or exceed 3 gal. per nominal ton (3.25 L per kW) of cooling for temperature stability and accuracy in normal air conditioning applications. In process cooling applications, or for operation at ambient temperature below 32°F (0°C) with low loading conditions, there should be from 6 to 10 gal. per ton (6.5 to 10.8 L per kW). To achieve this volume, it is often necessary to install a tank in the loop.

Tank should be baffled to ensure there is no stratification and that water (or brine) entering tank is adequately mixed with liquid in the tank.

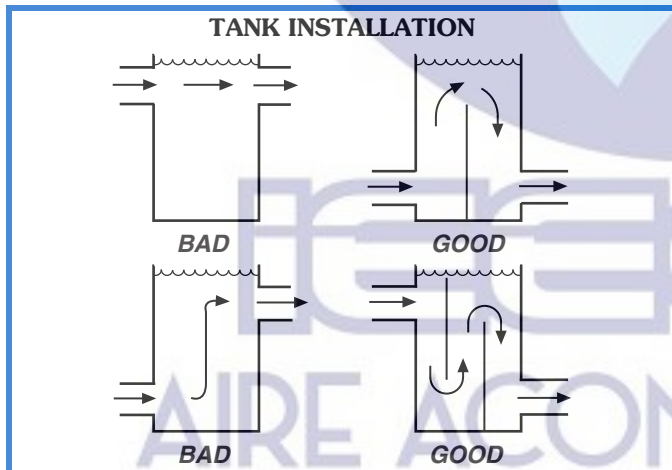

The piping between the chiller and the fluid loop volume tank can be done to allow the tank to be on the return side of the chiller (tank piped to chiller inlet) or the supply side of the chiller (tank piped to the chiller outlet). However, it is recommended that the tank be piped to the return side of the chiller to buffer any changes in load to allow more stable chiller operation.

### Minimum time to power chiller before start-up

In order to ensure that the crankcase heaters are provided sufficient time to raise the crankcase temperature to the required operating point, power must be applied to the control circuit a minimum of 24 hours prior to chiller start-up. On 30RB chillers, the control circuit obtains its power via a control transformer off the main 3-phase power supply. Therefore, the main (3-phase) power is to be supplied at least 24 hours prior to chiller start-up unless there are special means for providing control power.

### Cooler fouling factor

The fouling factor used to calculate tabulated ratings is 0.00010 ft<sup>2</sup> · hr · °F/Btu (0.000018 m<sup>2</sup> · °C/W). As fouling factor is increased, unit capacity decreases and compressor power increases. Corrections to published ratings can be approximated by using the multipliers in the fouling factors table.

#### FOULING FACTORS

FOULING FACTOR (English) (ft <sup>2</sup> ·hr·F/Btu)	FOULING FACTOR (SI) (m <sup>2</sup> ·C/W)	CAPACITY MULTIPLIER	COMPRESSOR POWER MULTIPLIER
0.00025	0.000044	0.991	0.995
0.00050	0.000088	0.977	0.987
0.00075	0.000132	0.955	0.979
0.00175	0.000308	0.910	0.952

### Cooler and hydronic system freeze protection

Freeze protection for down to -20°F (-28.9°C) for the cooler and hydronic package is standard. Since power is sometimes lost for extended periods during winter storms, freeze protection provided by heater tapes will be effective only if a back-up power supply can be assured for the unit's control circuit, heater and cooler pump. If not protected with an antifreeze solution, draining the cooler and outdoor piping is recommended if the system will not be used during freezing weather conditions.

Two conditions that must be considered when determining antifreeze concentration are leaving water set point and ambient freeze conditions. Both of these parameters can help determine the recommended concentration level. Higher concentration must be used to adequately protect the machine.

NOTE: Use only antifreeze solutions approved for heat exchanger duty.

For applications in which the leaving water temperature set point is less than 40°F (4.4°C), a suitable inhibited antifreeze solution must be used. The solution concentration must be sufficient to protect the chilled water loop to a freeze protection (first crystals) concentration of at least 15°F (8.3°C) below the leaving water temperature set point.

If the chiller refrigerant or fluid lines are in an area where ambient conditions fall below 34°F (1°C), it is required that an antifreeze solution be added to protect the unit and fluid piping to a temperature of 15°F (8.3°C) below the lowest anticipated ambient temperature.

Select concentration based on either burst or freeze protection as dictated by the application. If the chiller does not operate during the winter, nor is a start-up expected, a burst protection concentration is recommended. This concentration may not be high enough to pump the fluid through the unit. Burst protection is typically a lower concentration that will provide better performance from the machine. If the chiller does operate during winter, a freeze protection concentration is recommended. This concentration will be high enough to keep the fluid in a condition that it can be pumped at low ambient conditions.

**IMPORTANT:** Glycol anti-freeze solutions are highly recommended since heater tapes provide no protection in the event of a power failure.

Consult glycol fluid manufacturers for burst protection recommendations and fluid specifications.

### High ambient temperature operation

High outdoor ambient chiller start-up and operation is possible for standard 30RB chillers at ambient temperatures up to 125°F (52°C) at nominal voltage.

### Low ambient temperature operation

Units will start and operate down to 32°F (0°C) as standard.

NOTE: Minimum load on chiller must be above the minimum step of unloading.

With the inclusion of wind baffles (field-fabricated and installed) and low ambient head pressure control (low ambient control is not required on units with Greenspeed® intelligence) the unit is capable to start as low as -13°F (-25°C) and be operational to as low as -20°F (-29°C) ambient temperature. Inhibited propylene glycol or other suitable corrosion-resistant anti-freeze solution must be field supplied and installed in all units for unit operation below 34°F (1.1°C). Solution must be added to fluid loop to protect loop down to 15°F (8.3°C) below minimum operating ambient temperature. Concentration should be based on expected minimum temperature and either “Burst” or “Freeze” protection levels. At least 6 gal. per ton (6.5 L per kW) of water volume is the recommended minimum for a moderate system load.

### High-efficiency variable condenser fans

Highly efficient part load performance is available with variable speed condenser fan motors controlled by variable speed drives. In most applications, the chiller will run at

part load conditions the vast majority of the time, and this is particularly the case if the application has a 24/7 duty cycle. This option will lower utility costs while producing a scroll compressor design that provides excellent part load efficiency. This is the essence of 30RB chillers with Greenspeed® intelligence. (High-efficiency variable condenser fans are not available with sizes 060 and 070.)

### Altitude correction factors

Correction factors must be applied to standard ratings at altitudes above 2000 ft (610 m) using the following multipliers:

**ALTITUDE CORRECTION FACTORS**

ALTITUDE (ft)	ALTITUDE (m)	CAPACITY MULTIPLIER	COMPRESSOR POWER MULTIPLIER
2,000	610	0.99	1.01
4,000	1220	0.98	1.02
6,000	1830	0.97	1.03
8,000	2440	0.96	1.04
10,000	3050	0.95	1.05

### Condenser airflow

Airflow restrictions on units with standard fans will affect the unit capacity, condenser head pressure, and compressor power input. Correction factors to be applied for external static restrictions up to 0.2 in. wg (50 Pa) are as follows:

EXTERNAL STATIC		CAPACITY MULTIPLIER	COMPRESSOR POWER MULTIPLIER
in. wg	Pa		
0.0	0.0	1.000	1.00
0.1	25.0	0.986	1.01
0.2	50.0	0.968	1.03

### Condenser coil protection (Enviro-Shield™)

Refer to the environmental selection guides for more information. If the standard Novation® (microchannel) coil does not meet the corrosion requirements for a given application, additional coil options are available. For specific geographical recommendations, please refer to the NACO (North American Commercial Operations) Packaged Chiller Builder program.

**Aluminum fin/copper tube coils** are constructed of seamless copper tubes mechanically bonded to aluminum fins. The fins have wavy enhancements. These condenser coils are recommended with remote cooler applications. These coils are not recommended for corrosive environments.

**Pre-coated aluminum-fin coils** have a durable epoxy-phenolic coating applied to the fin prior to the fin stamping process to provide protection in mildly corrosive coastal environments. Pre-coated coils have an inert barrier between the aluminum fin and copper tube. This barrier electrically disconnects the dissimilar metals to minimize the potential for galvanic corrosion. This economical option provides substantial corrosion protection beyond the standard uncoated coil construction.

**Copper-fin coils** provide increased corrosion resistance compared to aluminum fin coils. All-copper coils eliminate bimetallic construction to eliminate the potential for galvanic corrosion. Application in industrial environments is not recommended due to potential attack from sulfur, sulfur oxide, nitrogen oxides, carbon and several other industrial airborne contaminants.

**E-coated Novation® coils** have an extremely flexible and durable epoxy coating uniformly applied to all coil surfaces. Unlike brittle phenolic dip and bake coatings, e-coat provides superior protection with unmatched flexibility, edge coverage, metal adhesion, thermal performance and most importantly, corrosion resistance. E-coated coils provide this protection since all coil surfaces are completely encapsulated from environmental contamination. This option provides the best protection for Novation coil technology. E-coated aluminum microchannel coils shall be capable of withstanding an 8000-hour salt spray test in accordance with the ASTM (American Society for Testing and Materials) (U.S.A.) B-117 Standard.

**E-coated aluminum-fin coils** have the same flexible and durable epoxy coating as e-coated Novation coils. This option provides better protection compared to standard or pre-coated aluminum-fin coils in many environments.

**E-coated copper-fin coils** have the same flexible and durable epoxy coating as other e-coated coils. However, this option combines the natural salt and environmental resistance of all-copper construction with the highest level of corrosion protection within the round-tube, plate-fin type of coils.

### Electrical/utility interests

Use of energy management practices can significantly reduce operating costs, especially during off-peak modes of operation. Demand limiting and temperature reset are 2 techniques for accomplishing efficient energy management. See Demand Limiting (also called load shedding) section below for further details.

### Demand limiting (load shedding)

When a utility's demand for electricity exceeds a certain level, loads are shed to keep electricity demand below a prescribed maximum level. Typically, this happens on hot days when air conditioning is most needed. The energy management module (EMM) can be added to accomplish this reduction. Demand may be limited on unit by resetting fluid temperature, or by unloading the chiller to a given predetermined percentage of the load. Demand limit may also be driven by an external 4 to 20 mA signal. These features require a signal from an intelligent central control. Do not cycle demand limiter for less than 10 minutes on and 5 minutes off. Duty cycling cycles electrical loads at regular intervals regardless of need. This reduces the electrical operating costs of building by "fooling" demand indicating devices. Duty cycling of compressors or fans is not recommended since motor winding and bearing life will suffer from constant cycling.

### Remote on-off control

Remote on-off control may be applied by hard-wired connection (see Controls and Troubleshooting literature) or by connection to a Carrier Comfort Network® (CCN) system.

### Optional hydronic system selection

Select pump gpm from resulting chiller selection and total pressure loss in the system plus the chiller internal pressure loss.

NOTE: Maximum gpm (L/s), pressure and pump hp must not exceed maximum on pump curve.

Pump flow can be reduced by using the factory-supplied triple-duty valve up to 10%. Beyond that, impeller trimming is recommended to reduce energy consumption. Follow local codes or ASHRAE 90.1 recommendations. Contact your Carrier representative for specific amount of trim required.

The AquaSnap® 30RB chiller will require a field-supplied expansion tank when the optional pumping package is provided.

The expansion tank is based on fluid type, temperature range, fluid pressure and loop volume.

Parallel chillers with hydronic packages require that pump inlets be equalized to prevent pump cavitation. Pump expansion tanks must be removed and located together in the common pump suction header. All materials needed for expansion tank relocation are field supplied. Appropriate measures must be taken for freeze protection.

### Air separation

The AquaSnap 30RB chiller will require a field-supplied air separation device when the optional pumping package is provided.

Air must be controlled in a hydronic system if it is to perform properly. Air can block the flow of chilled water to its destinations and can cause cavitation in the pump, which will aerate the pump and potentially cause pump failure. The air separator is sized according to the total flow through the system. The air separator should be located inside the building. There are several types of air separators to choose from. For more information and product selection contact your local manufacturer's representative.

### Heat reclaim (Desuperheater)

Whenever a chiller is operating, the heat removed from the cooler fluid, as well as, the energy associated with the compression process must be moved to another location. Under standard operation, an air-cooled chiller moves and releases this heat to the atmosphere. There are times, however, when it is beneficial to capture this heat and convert it into useful hot water.

A desuperheater, available with all coil types, may be used to serve this purpose. The desuperheater is available for sizes 080-300, and variable speed condenser fans are required when the desuperheater is employed. The leaving-water temperature can reach a maximum 140°F (60°C) under steady state and constant hot water flow conditions.

To operate in heat reclaim, there must be a simultaneous need for chilled water and tempered hot water. Just as the chiller operates in standard duty, the chiller always controls the leaving chilled water temperature.

The leaving hot-water temperature is a function of the entering hot water temperature, hot water flow and chiller capacity. As a consequence, these applications are useful for make-up water or preheating of process hot water systems that have alternative means of controlling the desired hot-water temperature.



### Freeze protection for desuperheater

The desuperheater is located within the standard chiller envelope. Therefore, this device, as well as its associated water piping, must be located outdoors. A form of freeze protection must be provided.

The same basic guidelines that have already been discussed for cooler freeze protection and preparation for winter shutdown must be followed. The Carrier warranty does not cover damage due to freezing. The piping, however, must either be provided with heat trace or an antifreeze solution must be added to the hot water fluid.

Adding antifreeze solution is the only certain means of protecting the unit from freeze-up if the heater fails or electrical power is interrupted or lost while temperatures are below 32°F (0°C).

### General heat reclaim application data

The desuperheater may be used with chiller sizes 30RB080-300, and with all coil types. The overall chiller dimensions are unchanged when the desuperheater is selected. The desuperheater water piping connections are Victaulic, and field-installed piping is connected to a header such that there is only 1 hot-water inlet and 1 hot-water outlet connection.

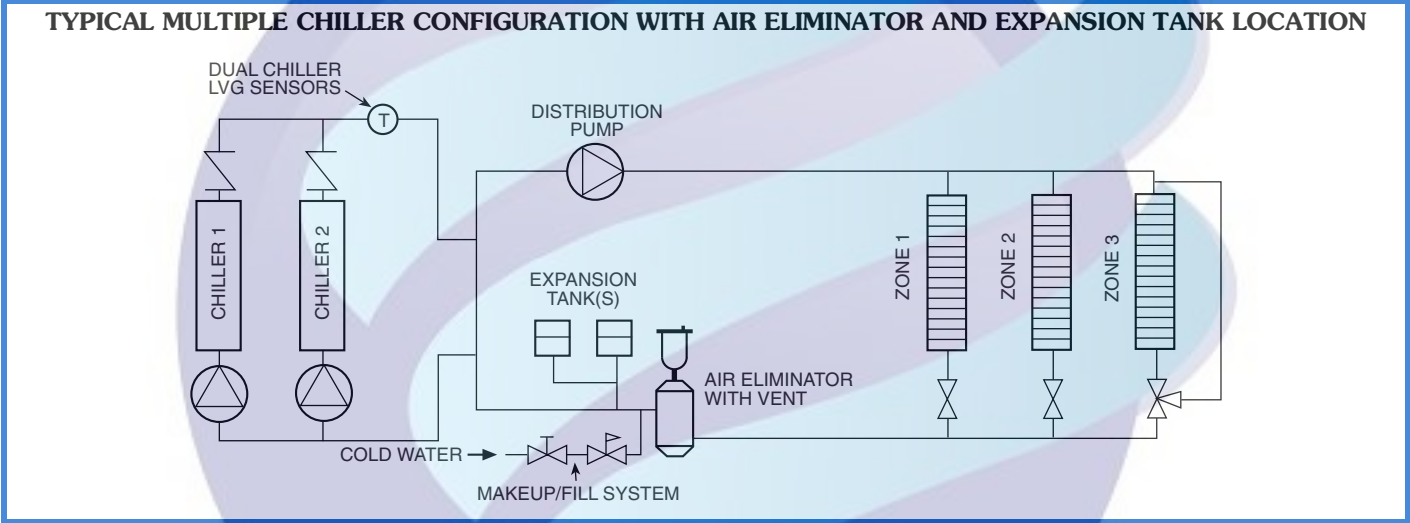

**IEEGCSA**  
**AIRE ACONDICIONADO**

## Outdoor Air-Cooled Liquid Chiller HVAC Guide Specifications

Size Range: **60 to 300 Tons**  
(**210 to 1055 kW**) Nominal  
**80 to 300 Tons**  
(**280 to 1055 kW**) Nominal with  
**Greenspeed® Intelligence**

Carrier Model Number: **30RB**

### Part 1 — General

#### 1.01 SYSTEM DESCRIPTION

Microprocessor controlled, air-cooled liquid chiller for outdoor installation, utilizing scroll compressors, low sound fans and optional hydronic pump system.

For units that incorporate Greenspeed intelligence, all fans are controlled with variable speed fan drive motors. Chiller software shall be specifically developed to coordinate optimal fan speed for application conditions and provide refrigerant circuit optimization, resulting in higher part-load efficiency and reduced acoustic levels.

NOTE: Hydronic pump packages are only available via ETO on 30RB060-190 units. Hydronic pump packages are not available on units with high SCCR option.

#### 1.02 QUALITY ASSURANCE

- A. Unit shall be rated in accordance with AHRI (Air-Conditioning, Heating and Refrigeration Institute) Standard 550/590, latest edition (U.S.A.) and all units shall be in compliance with ASHRAE (American Society of Heating, Refrigeration, and Air-Conditioning Engineers) 90.1.2007 and ASHRAE 90.1 2010.
- B. Unit construction shall comply with ASHRAE 15 Safety Code, UL (Underwriters Laboratories) latest edition, and ASME (American Society of Mechanical Engineers) applicable codes (U.S.A. codes).
- C. The management system governing the manufacture of this product is ISO 9001:2015 certified.
- D. An operational test, in which the chiller is run under load, is performed at the factory. This test checks for proper operation of fans as well as various controls and safeties, and a Certificate of Unit Testing, indicating successful end-of-line testing, is provided with the unit.

#### 1.03 DELIVERY, STORAGE AND HANDLING

- A. Unit controls shall be capable of withstanding 150°F (66°C) storage temperatures in the control compartment.
- B. Unit shall be stored and handled per unit manufacturer's recommendations.

### Part 2 — Products

#### 2.01 EQUIPMENT

##### A. General:

Factory assembled, single-piece air-cooled liquid chiller. Contained within the unit cabinet shall be all factory wiring, piping, controls, refrigerant charge

(R-410A), and special features required prior to field start-up.

##### B. Materials of Construction:

1. The base rail is industrial-quality, 7ga, zinc-dipped, galvanized frame (with Magni-coated screws).
2. Cabinet shall be galvanized steel casing with a baked enamel powder or pre-painted finish.
3. Painted parts shall withstand 1000 hours in constant neutral salt spray under ASTM B117 conditions with a 1 mm scribe per ASTM D1654. After test, painted parts shall show no signs of wrinkling or cracking, no loss of adhesion, no evidence of blistering, and the mean creepage shall not exceed  $\frac{1}{4}$  in. (Rating  $\geq 4$  per ASTM D1654) on either side of the scribe line.

##### C. Fans:

1. Condenser fans shall be direct-driven (VFD [variable frequency drive] controlled on units with Greenspeed intelligence), 9-blade airfoil cross-section, reinforced polymer construction, shrouded-axial type, and shall be statically and dynamically balanced with inherent corrosion resistance.
2. The variable speed drives for the condenser fans on 30RB units with Greenspeed intelligence shall include a DC link reactor.
3. Air shall be discharged vertically upward.
4. Fans shall be protected by coated steel wire safety guards.

##### D. Compressor/Compressor Assembly:

1. Fully hermetic scroll type compressors.
2. Direct drive, 3500 rpm (60 Hz), protected by motor temperature sensors, suction gas cooled motor.
3. External vibration isolation rubber-in-shear.
4. Each compressor shall be equipped with crank-case heaters to minimize oil dilution.

##### E. Cooler:

1. Shell-and-tube type, direct expansion.
2. Tubes shall be internally enhanced seamless-copper type rolled into tube sheets.
3. Shall be equipped with Victaulic-type water connections.
4. Shell shall be insulated with  $\frac{3}{4}$ -in. (19-mm) PVC foam (closed-cell) with a maximum K factor of 0.28.
5. Design shall incorporate a minimum of 2 independent direct-expansion refrigerant circuits.
6. Cooler shall be tested and stamped in accordance with ASME Code for a refrigerant working side pressure of 445 psig (3068 kPa). Cooler shall have a maximum water-side pressure of 300 psig (2068 kPa).

7. Cooler shall be provided with a factory-installed flow switch and heater.

#### F. Condenser:

1. Coil shall be air-cooled Novation® heat exchanger technology with microchannel (MCHX) coils and shall have a series of flat tubes containing a series of multiple, parallel flow microchannels layered between the refrigerant manifolds. Coils shall consist of a two-pass arrangement. Coil construction shall consist of aluminum alloys for fins, tubes, and manifolds in combination with a corrosion-resistant coating.
2. Tubes shall be cleaned, dehydrated, and sealed.
3. Assembled condenser coils shall be leak tested and pressure tested at 656 psig (4522 kPa).
4. To plan the chiller installation and for ease of maintenance/coil removal, all refrigerant piping entering and leaving the condenser coils shall be located on only one side of the chiller so the coils can be removed (when needed) from the side free of piping. This is important to consider because removing the coils from the header side, although possible, involves extra labor due to extra bending and brazing of the coil headers.

#### G. Refrigeration Components:

Refrigerant circuit components shall include replaceable-core filter drier, moisture indicating sight glass, electronic expansion device, discharge service valve and liquid line service valves, and complete operating charge of both refrigerant R-410A and compressor oil.

#### H. Controls, Safeties, and Diagnostics:

1. Unit controls shall include the following minimum components:
  - a. Microprocessor with non-volatile memory. Battery backup system shall not be accepted.
  - b. Separate terminal block for power and controls.
  - c. Control transformer to serve all controllers, relays, and control components.
  - d. ON/OFF control switch.
  - e. Replaceable solid-state controllers.
  - f. Pressure sensors shall be installed to measure suction and discharge pressure. Thermistors shall be installed to measure cooler entering and leaving fluid temperatures.
2. Unit controls shall include the following functions:
  - a. Automatic circuit lead/lag.
  - b. Hermetic scroll compressors are maintenance free and protected by an auto-adaptive control that minimizes compressor wear.
  - c. Capacity control based on leaving chilled fluid temperature and compensated by rate of change of return-fluid temperature with

temperature set point accuracy to 0.1°F (0.06°C).

- d. Limiting the chilled fluid temperature pull-down rate at start-up to an adjustable range of 0.2°F to 2°F (0.11°C to 1.1°C) per minute to prevent excessive demand spikes at start-up.
  - e. Seven-day time schedule.
  - f. Leaving chilled fluid temperature reset from return fluid and outside air temperature.
  - g. Chilled water pump start/stop control and primary/standby sequencing to ensure equal pump run time.
  - h. Dual chiller control for parallel chiller applications without addition of hardware modules and control panels (additional thermistors and wells are required).
  - i. Timed maintenance scheduling to signal maintenance activities for pumps, strainer maintenance and user-defined maintenance activities.
  - j. Low ambient protection to energize cooler or hydronic system heaters.
  - k. Periodic pump start to ensure pump seals are properly maintained during off-season periods.
  - l. Single step demand limit control activated by remote contact closure.
  - m. Nighttime sound mode to reduce the sound of the machine by a user-defined schedule.
- #### 3. Diagnostics:
- a. The control panel shall include, as standard, a scrolling marquee display capable of indicating the safety lockout condition by displaying a code for which an explanation may be scrolled at the display with time and date stamp.
  - b. Information included for display shall be:
    - 1) Compressor lockout.
    - 2) Loss of charge.
    - 3) Low fluid flow.
    - 4) Cooler coil freeze protection.
    - 5) Cooler set point.
    - 6) Chilled water reset parameters.
    - 7) Thermistor and transducer malfunction.
    - 8) Entering and leaving-fluid temperature.
    - 9) Evaporator and condenser pressure.
    - 10) System refrigerant temperatures.
    - 11) Chiller run hours.
    - 12) Compressor run hours.
    - 13) Compressor number of starts.  
Time of day:
      - a) Display module, in conjunction with the microprocessor, must also be capable of displaying the output (results) of a service test. Service test shall verify operation of every switch, thermistor, fan, and compressor before chiller is started.

- b) Diagnostics shall include the ability to review a list of the 30 most recent alarms with clear language descriptions of the alarm event. Display of alarm codes without the ability for clear language descriptions shall be prohibited.
- c) An alarm history buffer shall allow the user to store no less than 30 alarm events with clear language descriptions, time and date stamp event entry.
- d) The chiller controller shall include multiple connection ports for communicating with the local equipment network, the Carrier Comfort Network® (CCN) system and access to chiller control functions from any point on the chiller.
- e) The control system shall allow software upgrade without the need for new hardware modules.  
Crankcase heater failure.

#### 4. Safeties:

- a. Unit shall be equipped with thermistors and all necessary components in conjunction with the control system to provide the unit with the following protections:
  - 1) Loss of refrigerant charge.
  - 2) Reverse rotation.
  - 3) Low chilled fluid temperature.
  - 4) Thermal overload.
  - 5) High pressure.
  - 6) Electrical overload.
- b. Condenser fan and factory pump motors shall have external overcurrent protection.

#### I. Operating Characteristics:

- 1. Unit shall be capable of starting and running at outdoor ambient temperatures from 32°F to 125°F (0°C to 52°C) for all sizes.
- 2. Unit shall be capable of starting up with 95°F (35°C) entering fluid temperature to the cooler.

#### J. Motors:

Condenser-fan motors shall be totally enclosed single-speed, 3-phase type with permanently lubricated bearings and Class F insulation.

#### K. Electrical Requirements:

- 1. Unit/module primary electrical power supply shall enter the unit at a single location.
- 2. Unit shall operate on 3-phase power at the voltage shown in the equipment schedule.
- 3. Control points shall be accessed through terminal block.
- 4. Unit shall be shipped with factory control and power wiring installed.

#### L. Chilled Water Circuit:

- 1. Chilled water circuit shall be rated for 300 psig (2068 kPa). Units with optional pump package are rated for 150 psig (1034 kPa) working pressure.
- 2. Thermal dispersion proof of flow switch shall be factory installed and wired.
- 3. Optional hydronic package:
  - a. 30RB060-190 units only:
    - 1) Field pipe connections shall be Victaulic type.
    - 2) Optional single or primary/standby operation pump systems. Dual pump systems shall have a pump discharge check valve.
    - 3) Pumps shall be vertical in-line, single stage design, and capable of being serviced without disturbing piping connections.
      - a) Pump casing shall be of class 30 cast iron.
      - b) The impeller shall be of cast bronze, closed type, dynamically balanced, keyed to the shaft and secured by locking cap screw.
      - c) The hydronic kit will be provided with a flush line connection to ensure lubrication at the seal face and allow for positive venting of the seal chamber.
      - d) Each port shall be fitted with an isolation valve that allow the units to operate in parallel or standby, yet may be used to isolate one pumping unit for servicing or removal with the other pump still running.
      - e) Pump shall be rated for 150 psig (1034 kPa) working pressure.
      - f) The pump case shall have gage tapings at the suction and discharge nozzles and include drain ports.
      - g) Dual pumps shall allow for the servicing of one pump without draining the chilled water loop.
      - h) Motors shall be premium efficiency, totally enclosed fan cooled (TEFC) 3-phase type with grease lubricated ball bearings.
        - i) Each pump shall be factory tested per Hydraulic Institute Standards.
    - 4) Pressure/temperature taps (3) shall be factory installed to measure the pressure differential across the pump and across the strainer.
    - 5) Combination valve (which includes check, isolation, and modulation) shall be factory installed. Pressure/temperature taps (2) shall be factory installed to measure the pressure differential across the combination valve.
    - 6) Hydronic assembly shall have factory-supplied electric freeze protection to -20°F (-29°C).

- 7) Piping shall be Schedule 40 black steel.
- 8) Cast iron or ductile iron body 1/8-in. perforated strainer. A factory-installed, removable fine mesh start-up strainer for initial run period shall be included. The start-up strainer must be removed within 24 hours after chiller start-up.

#### M. Special Features:

Certain standard features are not applicable when the features designated by \* are specified. For assistance in amending the specifications, contact your Carrier representative.

##### 1. High-efficiency variable condenser fans:

All fans on the unit shall have variable speed fan motors to provide higher part load efficiency and reduced acoustic levels. Each fan circuit shall have a factory-installed, independent variable speed drive with display. Variable speed drives are rated IP-55 enclosures and UL Listed. The use of this option, with the addition of antifreeze in the cooler circuit and wind baffles, shall allow running with outdoor ambient temperatures down to -20°F (-28.9°C). This option is not available with sizes 060 and 070, and it is not available in combination with low ambient head pressure control.

##### \* 2. Low Ambient Head Pressure Control:

Unit shall be capable of running at outdoor ambient temperatures down to -20°F (-29°C) with the addition of antifreeze in the cooler circuit, wind baffles, and field-installed or factory-installed solid-state head pressure control with condenser coil minimum step capacity temperature sensor. This option or accessory is neither required nor available with the high-efficiency variable condenser fan option.

##### 3. Unit-Mounted Non-Fused Disconnect:

Unit shall be supplied with factory-installed, non-fused electrical disconnect for main power supply. This option is not available on 30RB060-120 with dual point power. This option is included with the high SCCR option.

##### 4. Optional Condenser Coil Materials:

###### a. E-coated microchannel coils:

E-coated aluminum microchannel coil shall have flexible epoxy polymer coating uniformly applied to all coil external surface areas without material bridging between fins or louvers. Coating process shall ensure complete coil encapsulation, including all exposed fin edges. E-coat shall have a thickness of 0.8 to 1.2 mil with top coat having a uniform dry film thickness from 1.0 to 2.0 mil on all external coil surface areas including fin edges. E-coated coils shall have superior hardness characteristics of 2H per ASTM D3363-00 and cross hatch adhesion of 4B-5B per ASTM D3359-02. Impact resistance shall be up to 160 in./lb

(ASTM D2794-93). E-coated coil shall have superior impact resistance with no cracking, chipping, or peeling per NSF/ANSI 51-2002 Method 10.2. E-coated aluminum micro-channel coils shall be capable of withstanding an 8000-hour salt spray test in accordance with the ASTM (American Society for Testing and Materials) (U.S.A.) B-117 Standard.

###### b. Aluminum fin/copper tube coils:

Coil shall be constructed of seamless copper tubes mechanically bonded to aluminum fins. Fins shall have wavy enhancements. These condenser coils are recommended with remote cooler applications. These coils are not recommended for corrosive environments.

###### c. Pre-coated aluminum-fin coils:

Coil shall have a durable epoxy-phenolic coating to provide protection in mildly corrosive coastal environments. Coating shall be applied to the aluminum fin stock prior to the fin stamping process to create an inert barrier between the aluminum fin and copper tube. Epoxy-phenolic barrier shall minimize galvanic action between dissimilar metals.

###### d. Copper-fin coils:

Coil shall be constructed of copper fins mechanically bonded to copper tubes and copper tube sheets. Galvanized steel tube sheets shall not be acceptable. A polymer strip shall prevent coil assembly from contacting sheet metal coil pan to minimize potential for galvanic corrosion between the coil and pan. All-copper construction shall provide protection in moderate coastal applications.

###### e. E-coated aluminum-fin coils:

Coil shall have a flexible epoxy polymer coating uniformly applied to all coil surface areas without material bridging between fins. Coating process shall ensure complete coil encapsulation. Color shall be high gloss black with gloss — 60° of 65 to 90% per ASTM ID523-89. Uniform dry film thickness from 0.8 to 1.2 mil on all surface areas including fin edges. Superior hardness characteristics of 2H per ASTM D3363-92A and cross hatch adhesion of 4B-5B per ASTM D3359-93. Impact resistance shall be up to 160 in./lb (ASTM D2794-93). Humidity and water immersion resistance shall be up to minimum 1000 and 250 hours respectively (ASTM D2247-92 and ASTM D870-92). Corrosion durability shall be confirmed through testing to no less than 3000 hours salt spray per ASTM B117-90. Coil construction shall be aluminum fins mechanically bonded to copper tubes.

- f. E-coated copper-fin coils:  
Coil shall have a flexible epoxy polymer coating uniformly applied to all coil surface areas without material bridging between fins. Coating process shall ensure complete coil encapsulation. Color shall be high gloss black with gloss — 60° of 65 to 90% per ASTM D523-89. Uniform dry film thickness from 0.8 to 1.2 mil on all surface areas including fin edges. Superior hardness characteristics of 2H per ASTM D3363-92A and cross hatch adhesion of 4B-5B per ASTM D3359-93. Impact resistance shall be up to 160 in./lb (ASTM D2794-93). Humidity and water immersion resistance shall be up to minimum 1000 and 250 hours respectively (ASTM D2247-92 and ASTM D870-92). Corrosion durability shall be confirmed through testing to no less than 3000 hours salt spray per ASTM B117-90. Coil construction shall be copper-fins mechanically bonded to copper tube sheets. Galvanized steel tube sheets shall not be acceptable. A polymer strip shall prevent coil assembly from contacting sheet metal coil pan to maintain coating integrity and minimize corrosion potential between the coil and pan.
5. Heat Reclaim (Desuperheater):  
Unit shall be equipped with a desuperheater (on sizes 080-300) to obtain beneficial use of some of the system heat rejection.
- a. Desuperheater shall be of brazed-plate design, and be rated for a maximum refrigerant pressure of 653 psig (4506 kPa).
- b. Desuperheater plates shall be of stainless-steel construction.
- c. Water connections shall be Victaulic.
- d. One desuperheater per refrigerant circuit shall be provided, but the system water piping shall be of header construction so that only one inlet and one outlet water connection is required.
- e. Chillers employing desuperheaters must also employ variable speed condenser fans.
- f. For all climates which experience temperatures below 32°F (0°C), a form of freeze protections must be field-supplied (some type of glycol is recommended).
- g. A strainer with a minimum of 40 mesh must be installed within 10 ft (3 m) of the desuperheater fluid inlet to prevent debris from clogging the heat exchanger.
6. Remote Enhanced Display:  
Unit shall be supplied with indoor-mounted, remote, 40-character per line, 16-line display panel for field installation.
7. Chillervisor System Manager Multi-Unit Control:  
Field-installed control shall sequence between 2 and 8 chillers in parallel in a single system.
8. Minimum Load Control:  
Unit shall be equipped with field-installed, microprocessor-controlled, minimum load control that shall permit unit operation down to a minimum of 6% capacity (varies with unit size). This accessory is not available on applications with leaving fluid temperature less than 38°F (3.3°C).
9. Energy Management Control Module:  
A factory or field-installed module shall provide the following energy management capabilities: 4 to 20 mA signals for leaving fluid temperature reset, cooling set point reset or demand limit control; 2-step demand limit control (from 0% to 100%) activated by a remote contact closure; and discrete input for “Ice Done” indication for ice storage system interface.
10. Condenser Coil Trim Panels and Security Grilles:  
Unit shall be supplied with factory or field-installed coil covers and painted grilles to protect the condenser coil and internal chiller components from physical damage.
11. Upper Hail Guard:  
Unit shall be equipped with a factory-installed option consisting of louvered panels on the ends of the machine which firmly fasten to the machine frame. These panels shall cover the unit from the top to the bottom of the coils, thus providing protection of the coils from hail damage.
12. Full Hail Guard:  
Unit shall be equipped with field-installed accessory consisting of hinged, louvered panels, which cover both ends of the unit. This accessory provides complete protection from hail.
13. Full End Screen:  
Unit shall be equipped with a factory-installed option consisting of louvered panels that cover the machine ends from top to bottom and firmly fasten to the machine frame. These end screens function as a privacy screen and also provide hail protection.
14. BACnet<sup>1</sup> Communication:  
Shall provide pre-programmed factory-installed communication capability with a BACnet MS/TP network. Allows integration with i-Vu<sup>®</sup> Open control system or a third-party BACnet building automation system. No field programming shall be required.

1. BACnet is a registered trademark of ASHRAE (American Society of Heating, Refrigeration, and Air Conditioning Engineers).

15. BACnet/Modbus<sup>1</sup> Translator Control:  
Unit shall be supplied with factory or field-installed interface between the chiller and a BACnet Local Area Network (LAN, i.e., MS/TP EIA-485). Field programming shall be required.
16. LON Translator Control:  
Unit shall be supplied with factory or field-installed interface between the chiller and a Local Operating Network (LON, i.e., LonWorks<sup>2</sup> FT-10A ANSI/EIA-709.1). Field programming is required.
17. Navigator™ Hand Held Display:
- Portable hand held display module with a minimum of 4 lines and 20 characters per line, of clear English, Spanish, Portuguese or French language.
  - Display menus shall provide clear language descriptions of all menu items, operating modes, configuration points and alarm diagnostics. Reference to factory codes shall not be accepted.
  - RJ-14 connection plug shall allow display module to be connected to factory-installed receptacle.
  - Industrial grade coiled extension cord shall allow the display module to be moved around the chiller.
  - Magnets shall hold the display module to any sheet metal panel to allow hands-free operation.
  - Display module shall have NEMA (National Electrical Manufacturers Association) 4x housing suitable for use in outdoor environments.
  - Display shall have back light and contrast adjustment for easy viewing in bright sunlight or night conditions.
  - Raised surface buttons with positive tactile response.
18. Touch Pilot™ Display:  
Unit shall be supplied with a remote mount touch screen display for network attachment to the chiller.
19. Compressor Suction Service Valve:  
Standard refrigerant discharge isolation and liquid valves shall enable service personnel to store the refrigerant charge in the cooler or condenser during servicing. This factory-installed option (one valve per refrigerant circuit) shall allow for further isolation of the compressor from the cooler vessel.
20. Suction Line Insulation:  
Insulation shall be tubular closed-cell insulation. This option shall be required on applications with leaving fluid temperatures below 30°F (-1.1°C) and recommended for areas of high dewpoints where condensation may be a concern.
21. Remote Cooler Kit:  
Shall allow remote installation of cooler. Kit shall include expansion valve and flow switch cable extensions, and instructions.
22. CRN Cooler (Canada Only):  
Shall provide minor cooler modifications to meet Canadian code.
23. Compressor Sound Reduction:  
Shall provide sound reduction for the scroll compressors.
- Unit shall be equipped with factory-installed option low sound - compressor sound reduction blanket which reduces unit sound levels by providing an acoustic blanket on each compressor.
  - Unit shall be equipped with factory-installed option ultra low sound - compressor sound reduction enclosure which provides an enclosure to encase each compressor that is covered with an acoustic blanket.
24. High SCCR (Short Circuit Current Rating):  
The optional high SCCR (short circuit current rating) device shall allow the chiller to tolerate a 65 kA short circuit current for a brief period of time while protecting downstream components. The high SCCR option shall provide a higher level of protection than the standard unit. This option is not available on 30RB250-300 units. This option includes the unit-mounted non-fused disconnect option. This option is only available in 460-v units.
25. Dual Chiller Accessory Kit:  
For dual chiller applications (with units piped in parallel), unit shall be provided with the additional hardware (thermistors, wells, connectors) required for proper system operation.
26. GFI Convenience Outlet:  
Shall be factory or field-installed and mounted with easily accessible 115-v female receptacle and shall include a 4-amp GFI receptacle.
27. Seismic Certification:  
A seismic unit modification is available which will result in a unit SDS (seismic design acceleration parameter) level of 2.0.

1. Modbus is a registered trademark of Schneider Electric.

2. LonWorks is a registered trademark of Echelon Corporation.



# IEEGCSA

## AIRE ACONDICIONADO

