



Installation Instructions

CONTENTS

	Page
SAFETY CONSIDERATIONS	1
INSTALLATION	2
Storage Recommendations	2
Step 1 — Place and Rig the Unit	2
• PLACING UNIT	
• RIGGING	
• MOUNTING UNIT	
Step 2 — Check Compressor Mounting	18
Step 3 — Connect Cooler Fluid and Drain Piping	18
• ALL UNITS	
• VICTAULIC COUPLING INSTALLATION	
• UNITS WITH FACTORY-INSTALLED HYDRONIC PACKAGES	
• AIR SEPARATION	
Step 4 — Fill the Chilled Water Loop	34
• WATER SYSTEM CLEANING	
• FILLING THE SYSTEM	
• PUMP VFD	
• SENSORLESS CONTROL (CLOSED LOOP) — ACTIVE SETUP 1	
• REMOTE SENSOR (CLOSED LOOP) — ACTIVE SETUP 2	
• REMOTE CONTROLLER (OPEN LOOP) — ACTIVE SETUP 3	
• PREPARATION FOR YEAR-ROUND OPERATION	
• FREEZE PROTECTION	
• PREPARATION FOR WINTER SHUTDOWN	
Step 5 — Make Electrical Connections	45
• POWER SUPPLY	
• POWER WIRING	
• CONTROL POWER	
Step 6 — Install Accessories	67
• ELECTRICAL	
Step 7 — Check Refrigerant Circuit	67
• LEAK TESTING	
• DEHYDRATION	
• REFRIGERANT CHARGE	
BACnet Communication Option Wiring	68
APPENDIX A (PRESSURE DROP CURVES)	71

SAFETY CONSIDERATIONS

Installing, starting up, and servicing air-conditioning equipment can be hazardous due to system pressures, electrical components, and equipment location (roofs, elevated structures, etc.).

Only trained, qualified installers and service mechanics should install, start up, and service this equipment (Fig. 1).

Untrained personnel can perform basic maintenance functions such as cleaning coils. All other operations should be performed by trained service personnel.

When working on the equipment, observe precautions in the literature and on tags, stickers, and labels attached to the equipment.

- Follow all safety codes.

- Wear safety glasses and work gloves.
- Keep quenching cloth and fire extinguisher nearby when brazing.
- Use care in handling, rigging, and setting bulky equipment.

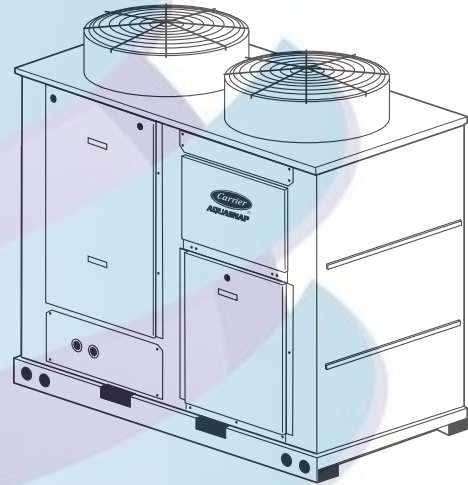

Fig. 1 — Typical 30RAP Unit (018-030 Shown)

WARNING

Electrical shock can cause personal injury and death. Shut off all power to this equipment during installation. There may be more than one disconnect switch. Tag all disconnect locations to alert others not to restore power until work is completed.

WARNING

DO NOT USE TORCH to remove any component. System contains oil and refrigerant under pressure.

To remove a component, wear protective gloves and goggles and proceed as follows:

- Shut off electrical power to unit.
- Recover refrigerant to relieve all pressure from system using both high-pressure and low pressure ports.
- Traces of vapor should be displaced with nitrogen and the work area should be well ventilated. Refrigerant in contact with an open flame produces toxic gases.
- Cut component connection tubing with tubing cutter and remove component from unit. Use a pan to catch any oil that may come out of the lines and as a gage for how much oil to add to the system.
- Carefully unsweat remaining tubing stubs when necessary. Oil can ignite when exposed to torch flame.

Failure to follow these procedures may result in personal injury or death.

CAUTION

DO NOT re-use compressor oil or any oil that has been exposed to the atmosphere. Dispose of oil per local codes and regulations. DO NOT leave refrigerant system open to air any longer than the actual time required to service the equipment. Seal circuits being serviced and charge with dry nitrogen to prevent oil contamination when timely repairs cannot be completed. Failure to follow these procedures may result in damage to equipment.

INSTALLATION

Storage Recommendations — The 30RAP air-cooled chillers are designed for outdoor installations. At times, a delay in construction or other factors require that a unit be stored for a period of time prior to installation. The following guidelines should be used for unit storage.

PROVIDE MACHINE PROTECTION — Place and store the unit in an area that will protect it from vandalism, accidental contact with vehicles, falling debris or construction waste. Ideally, do not remove the shipping protection such as the coil protectors. This will provide additional protection for the unit. The unit can be stored outdoors.

INSPECTION DURING STORAGE — To ensure faster installation when the time comes, the following inspection schedule is recommended:

Every 3 Months — The 30RAP units are shipped with a complete operating charge of R-410A. Check each refrigerant circuit to be sure that there is positive pressure, at least 26 psig (180 kPa) in the circuit. If a circuit is found to be without pressure, contact a qualified refrigeration mechanic. The system should be pressurized to find the leak. It should be repaired, dehydrated, and recharged with refrigerant. If a positive circuit pressure was not found, the compressor oil should be changed or at least sampled to determine if moisture is present. If moisture is found in the compressor oil, the oil should be changed.

Every 6 Months — Check the unit for damage, both physical and from wildlife. Check the unit for nests from rodents, birds, or insects. Depending on location, these organisms can cause deterioration of components which may result in failure. Consider an exterminator if necessary. If damage is found and it will interfere with the installation, consider repairing the damage before installation. Check the unit control box for signs of moisture. If moisture is found, determine the entry path and seal the leak.

Step 1 — Place and Rig the Unit

PLACING UNIT — Units are suitable for outdoor use only. For 30RAP011-060 units, see Fig. 2. When parallel chillers are aligned such that coils face each other, a minimum of 6 ft (1829 mm) separation is recommended. When the parallel arrangement has only one coil drawing air from the space between chillers, a minimum of 3.5 ft (1067 mm) is recommended. When parallel chillers have no coils facing each other (a back-to-back arrangement), be sure to maintain the larger of the recommended service clearances associated with each chiller (see the certified drawings). Due to NEC (National Electric Code) regulations, a minimum clearance of 4 ft (1219 mm) must be maintained on the side of the chiller that has an electrical box. Chiller fan discharge must be at least as high as adjacent solid walls. Installation in pits is not recommended.

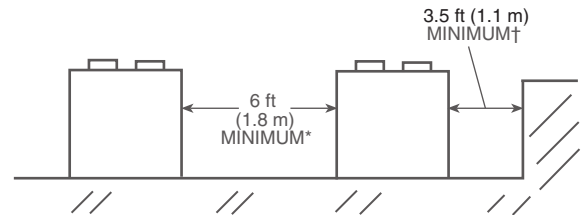

* Minimum for when coils face each other. Less clearance is required in other configurations.

† Clearance of 3.5 ft is required when a coil faces the wall. When there is no coil facing the wall, see the certified drawing for the required service clearance.

Fig. 2 — 30RAP011-060 Multiple Unit Separation

For 30RAP070-150 units, see Fig. 3. When chillers are arranged in parallel, a minimum of 10 ft (3048 mm) between chillers is recommended. Acceptable clearance on the cooler connection side or end opposite the control box of the unit can be reduced to 3 ft (1 m) without sacrificing performance as long as the remaining three sides are unrestricted. Acceptable clearance on the side with a control box can be reduced to 4 ft (1.3 m) due to NEC (National Electric Code) regulations, without sacrificing performance as long as the remaining three sides are unrestricted. Clearances between chillers in dual chiller applications may be reduced to 6 ft (1.8 m) without sacrificing performance provided the remaining sides are unrestricted. For acceptable clearance with layout involving more than 2 chillers, please contact application engineering.

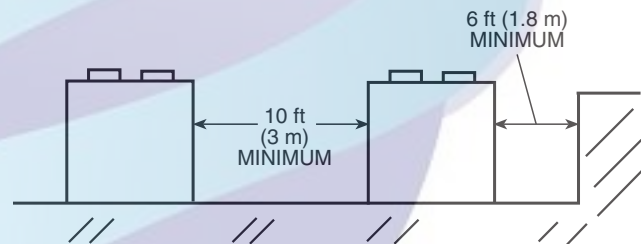

Fig. 3 — 30RAP070-150 Multiple Unit Separation

These instructions cover installation of 30RAP011-150 air-cooled liquid chillers. Refer to Fig. 4 and 5 for model number to determine factory-installed options.

RIGGING — Preferred method for rigging is with spreader bars from above the unit. Use shackles in lifting holes. Rig at a single point with 4 cables for size 011-115 units, 6 cables for size 130 and 150 units, or use spread bars. All panels must be in place when rigging. See rigging label on unit for details concerning shipping weights, distance between lifting holes, center of gravity, and lifting ring dimensions. See Tables 1-3 and Fig. 6 for unit weights. See Tables 6 and 7 for physical data. See Fig. 7 and 8 for rigging label.

If overhead rigging is not possible, place chiller on skid or pad for rolling or dragging. When rolling, use a minimum of 3 rollers. When dragging, pull the pad. *Do not apply force to the unit.* When in final position, raise from above to lift unit off pad.

CAUTION

All panels must be in place when rigging. If they are not, damage to unit could result.

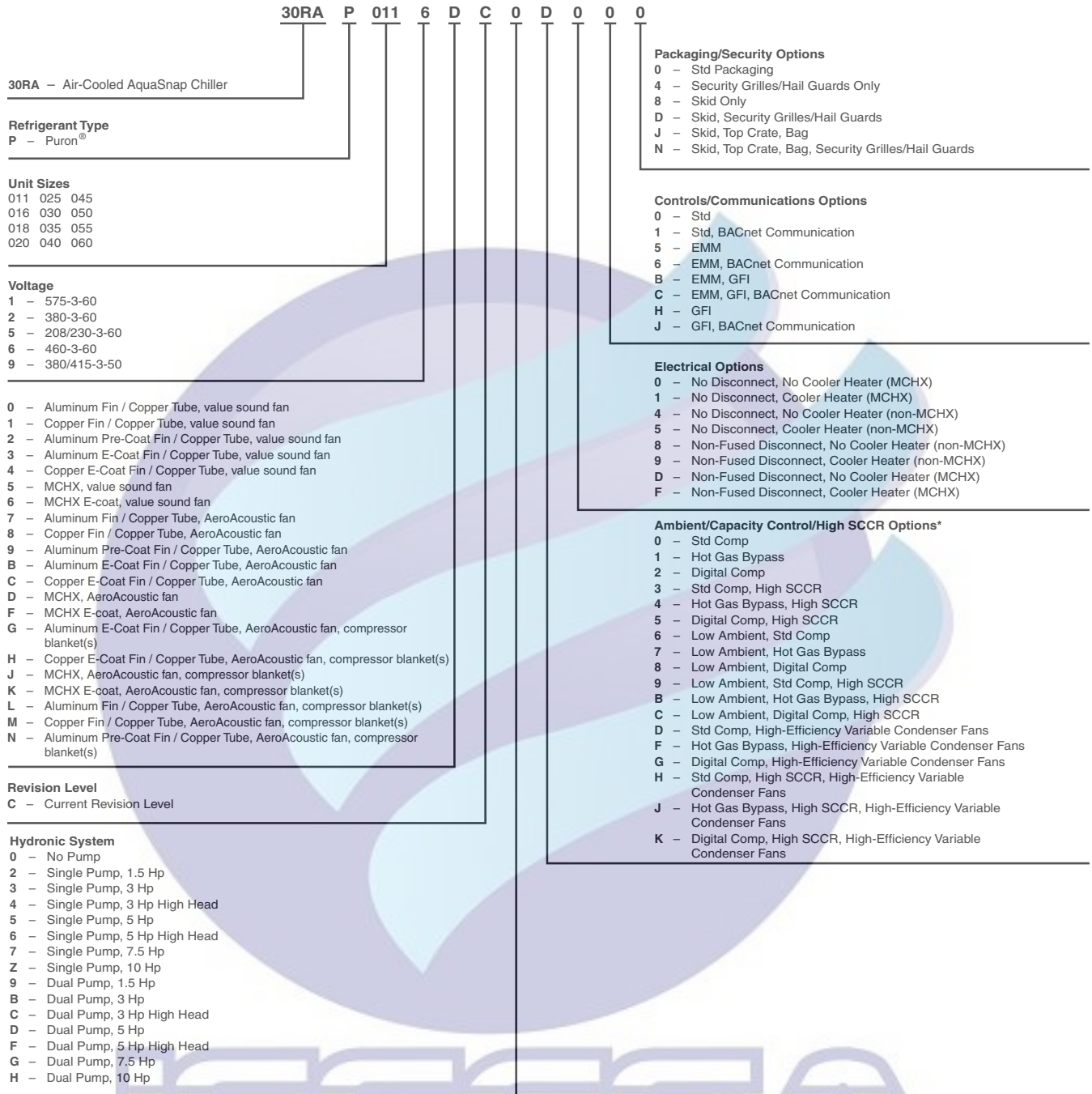

*High-efficiency variable condenser fans (codes D, F, G, H, J, and K) are the only choices for sizes 011 and 016.

LEGEND

- EMM** — Energy Management Module
- GFI** — Ground Fault Interrupting
- MCHX** — Microchannel Heat Exchanger
- SCCR** — Short Circuit Current Rating

Fig. 4 — AquaSnap® Chiller Model Number Designation, 30RAP011-060

30RA P 070 6 D B 0 6 0 0 0

30RA – Air-Cooled AquaSnap Chiller

Refrigerant Type

P – Puron®

Unit Sizes

070 115
080 130
090 150
100

Voltage

1 – 575-3-60
2 – 380-3-60
5 – 208/230-3-60
6 – 460-3-60
9 – 380/415-3-50

Condenser Coil and Low Sound Options

0 – Aluminum/Copper, Value Sound Fan
1 – Copper/Copper, Value Sound Fan
2 – Aluminum/Copper, Pre-Coat, Value Sound Fan
3 – Aluminum/Copper, E-Coat, Value Sound Fan
4 – Copper/Copper, E-Coat, Value Sound Fan
5 – MCHX, Value Sound Fan
6 – MCHX, E-Coat, Value Sound Fan
7 – Aluminum/Copper, AeroAcoustic™ Fan
8 – Copper/Copper, AeroAcoustic Fan
9 – Copper/Aluminum, Pre-Coat, AeroAcoustic Fan
B – Copper/Aluminum, E-Coat, AeroAcoustic Fan
C – Copper/Copper, E-Coat, AeroAcoustic Fan
D – MCHX, AeroAcoustic Fan
F – MCHX, E-Coat, AeroAcoustic Fan
J – MCHX, AeroAcoustic Fan, Compressor Blanket(s)
K – MCHX, E-Coat, AeroAcoustic Fan, Compressor Blanket(s)
L – Aluminum/Copper, AeroAcoustic Fan, Compressor Blanket(s)
M – Copper/Copper, AeroAcoustic Fan, Compressor Blanket(s)
N – Aluminum/Copper, Pre-Coat, AeroAcoustic Fan, Compressor Blanket(s)
P – Aluminum/Copper, E-Coat, AeroAcoustic Fan, Compressor Blanket(s)
Q – Copper/Copper, E-Coat, AeroAcoustic Fan, Compressor Blanket(s)

Revision Level

B – Current Revision Level

Hydronic System

0 – No Pump
2 – Single Pump, 5 Hp
3 – Single Pump, 7.5 Hp
4 – Single Pump, 10 Hp
5 – Single Pump, 15 Hp
8 – Dual Pump, 7.5 Hp
9 – Dual Pump, 10 Hp
B – Dual Pump, 15 Hp
D – Single Pump, 5 Hp with VFD
F – Single Pump, 7.5 Hp with VFD
G – Single Pump, 10 Hp with VFD
H – Single Pump, 15 Hp with VFD
L – Dual Pump, 7.5 Hp with VFD
M – Dual Pump, 10 Hp with VFD
N – Dual Pump, 15 Hp with VFD

Packaging/Security Options

0 – Std Packaging
4 – Security Grilles/Hail Guards Only
8 – Skid Only
D – Skid, Security Grilles/Hail Guards
J – Skid, Top Crate, Bag
N – Skid, Top Crate, Bag, Security Grilles/Hail Guards

Controls/Communications Options

0 – Std
1 – Std, BACnet Communication
5 – EMM
6 – EMM, BACnet Communication
B – EMM, GFI
C – EMM, GFI, BACnet Communication
H – GFI
J – GFI, BACnet Communication

Electrical Options

0 – Single Point, No Disconnect, No Cooler Heater
1 – Single Point, No Disconnect, Cooler Heater
2 – Single Point, Non-Fused Disconnect, No Cooler Heater
3 – Single Point, Non-Fused Disconnect, Cooler Heater
4 – Dual Point, No Disconnect, No Cooler Heater
5 – Dual Point, No Disconnect, Cooler Heater

Ambient/Capacity Control/High SCCR Options

0 – Std Comp
1 – Hot Gas Bypass
2 – Digital Comp
3 – Std Comp, High SCCR
4 – Hot Gas Bypass, High SCCR
5 – Digital Comp, High SCCR
6 – Low Ambient, Std Comp
7 – Low Ambient, Hot Gas Bypass
8 – Low Ambient, Digital Comp
9 – Low Ambient, Std Comp, High SCCR
B – Low Ambient, Hot Gas Bypass, High SCCR
C – Low Ambient, Digital Comp, High SCCR
D – Std Comp, Suction Service Valve
F – Hot Gas Bypass, Suction Service Valve
G – Digital Comp, Suction Service Valve
H – Std Comp, High SCCR, Suction Service Valve
J – Hot Gas Bypass, High SCCR, Suction Service Valve
K – Digital Comp, High SCCR, Suction Service Valve
L – Low Ambient, Std Comp, Suction Service Valves
M – Low Ambient, Hot Gas Bypass, Suction Service Valves
N – Low Ambient, Digital Comp, Suction Service Valves
P – Low Ambient, Std Comp, High SCCR, Suction Service Valves
Q – Low Ambient, Hot Gas Bypass, High SCCR, Suction Service Valves
R – Low Ambient, Digital Comp, High SCCR, Suction Service Valves



LEGEND

EMM — Energy Management Module
GFI — Ground Fault Interrupting
MCHX — Microchannel Heat Exchanger
SCCR — Short Circuit Current Rating
VFD — Variable Frequency Drive

Fig. 5 — AquaSnap® Chiller Model Number Designation, 30RAP070-150

Table 1 — Unit Operating Weights

MCHX COIL, NO PUMP UNITS

30RAP SIZE	WEIGHT AT MOUNTING POINTS (lb)							30RAP SIZE	WEIGHT AT MOUNTING POINTS (kg)						
	A	B	C	D	E	F	Total Weight		A	B	C	D	E	F	Total Weight
011	243	187	144	187	—	—	762	011	110	85	66	85	—	—	346
016	261	195	147	197	—	—	800	016	119	88	67	89	—	—	363
018	363	264	209	288	—	—	1125	018	165	120	95	131	—	—	510
020	365	266	211	290	—	—	1133	020	166	121	96	132	—	—	514
025	393	290	237	321	—	—	1242	025	178	132	108	146	—	—	564
030	405	301	246	331	—	—	1283	030	184	136	112	150	—	—	582
035	652	730	413	369	—	—	2163	035	296	331	187	167	—	—	981
040	704	697	390	394	—	—	2185	040	319	316	177	179	—	—	991
045	675	758	425	379	—	—	2238	045	306	344	193	172	—	—	1015
050	732	724	401	405	—	—	2263	050	332	328	182	184	—	—	1026
055	744	762	437	427	—	—	2369	055	337	346	198	193	—	—	1075
060	746	762	438	429	—	—	2375	060	338	346	199	194	—	—	1077
070	930	984	727	770	—	—	3410	070	422	446	330	349	—	—	1547
080	936	1038	791	877	—	—	3641	080	425	471	359	398	—	—	1652
090	952	1057	800	888	—	—	3697	090	432	479	363	403	—	—	1677
100	779	805	963	617	595	931	4690	100	353	365	437	280	270	422	2127
115	796	824	1027	697	672	991	5008	115	361	374	466	316	305	450	2272
130	1100	1179	1430	680	682	1380	6451	130	499	535	649	309	309	626	2926
150	1120	1205	1554	779	781	1499	6938	150	508	546	705	353	354	680	3147

MCHX COIL, SINGLE PUMP UNITS

30RAP SIZE	WEIGHT AT MOUNTING POINTS (lb)							30RAP SIZE	WEIGHT AT MOUNTING POINTS (kg)						
	A	B	C	D	E	F	Total Weight		A	B	C	D	E	F	Total Weight
011	264	249	200	212	—	—	925	011	120	113	91	96	—	—	419
016	282	257	202	222	—	—	963	016	128	117	92	101	—	—	437
018	393	317	258	320	—	—	1288	018	178	144	117	145	—	—	584
020	395	319	260	322	—	—	1296	020	179	145	118	146	—	—	588
025	423	343	286	353	—	—	1405	025	192	155	130	160	—	—	637
030	436	352	294	364	—	—	1446	030	198	160	133	165	—	—	656
035	692	863	529	424	—	—	2507	035	314	391	240	192	—	—	1137
040	743	832	504	450	—	—	2529	040	337	377	229	204	—	—	1147
045	715	891	541	434	—	—	2582	045	324	404	245	197	—	—	1171
050	771	858	515	462	—	—	2606	050	350	389	234	210	—	—	1182
055	783	895	552	483	—	—	2713	055	355	406	250	219	—	—	1231
060	785	896	553	485	—	—	2719	060	356	406	251	220	—	—	1233
070	1036	1032	871	874	—	—	3812	070	470	468	395	396	—	—	1729
080	1054	1070	963	948	—	—	4035	080	478	485	437	430	—	—	1830
090	1063	1082	967	950	—	—	4061	090	482	491	438	431	—	—	1842
100	1105	871	886	823	554	850	5089	100	501	395	402	373	252	385	2308
115	1121	892	948	904	631	912	5407	115	508	405	430	410	286	414	2453
130	1418	1252	1415	817	615	1333	6850	130	643	568	642	370	279	605	3107
150	1437	1280	1537	916	714	1453	7337	150	652	581	697	415	324	659	3328

MCHX COIL, DUAL PUMP UNITS

30RAP SIZE	WEIGHT AT MOUNTING POINTS (lb)							30RAP SIZE	WEIGHT AT MOUNTING POINTS (kg)						
	A	B	C	D	E	F	Total Weight		A	B	C	D	E	F	Total Weight
011	285	312	256	234	—	—	1087	011	129	142	116	106	—	—	493
016	303	320	257	244	—	—	1125	016	138	145	117	111	—	—	510
018	422	370	307	350	—	—	1450	018	191	168	139	159	—	—	658
020	424	372	309	352	—	—	1458	020	192	169	140	160	—	—	661
025	452	396	336	383	—	—	1567	025	205	180	152	174	—	—	711
030	465	405	344	394	—	—	1608	030	211	184	156	179	—	—	729
035	734	993	646	477	—	—	2850	035	333	451	293	216	—	—	1293
040	783	964	621	505	—	—	2872	040	355	437	282	229	—	—	1303
045	757	1022	659	488	—	—	2925	045	343	464	299	221	—	—	1327
050	811	991	631	517	—	—	2950	050	368	449	286	234	—	—	1338
055	824	1027	669	537	—	—	3056	055	374	466	303	243	—	—	1386
060	826	1027	670	539	—	—	3062	060	375	466	304	244	—	—	1389
070	1123	1036	928	1005	—	—	4092	070	509	470	421	456	—	—	1856
080	1159	1094	1038	1099	—	—	4390	080	526	496	471	499	—	—	1991
090	1167	1104	1041	1099	—	—	4411	090	529	501	472	499	—	—	2001
100	1353	908	820	990	506	797	5374	100	614	412	372	449	229	361	2438
115	1367	931	881	1070	583	860	5692	115	620	422	400	485	264	360	2582
130	1658	1297	1404	922	559	1295	7135	130	752	588	637	418	254	587	3236
150	1676	1326	1526	1020	659	1415	7622	150	760	601	692	463	299	642	3457

NOTES:

1. See Fig. 6 for unit mounting points.

2. 30RAP chillers with Greenspeed® intelligence are not available on unit sizes 070-150.

Table 2 — Unit Operating Weights (Al/Cu Coil)
AL/CU COIL, NO PUMP UNITS

30RAP SIZE	POUNDS							Total Weight	30RAP SIZE	KILOGRAMS							Total Weight
	A	B	C	D	E	F	A			B	C	D	E	F			
011	244	192	170	216	—	—	822	011	111	87	77	98	—	—	373		
016	263	200	171	226	—	—	860	016	119	91	78	102	—	—	390		
018	367	267	237	326	—	—	1197	018	166	121	108	148	—	—	543		
020	369	269	239	328	—	—	1205	020	167	122	108	149	—	—	547		
025	397	293	273	369	—	—	1332	025	180	133	124	167	—	—	604		
030	409	303	281	379	—	—	1372	030	185	138	128	172	—	—	623		
035	695	779	440	393	—	—	2308	035	315	353	200	178	—	—	1047		
040	751	744	416	420	—	—	2330	040	340	337	189	190	—	—	1057		
045	729	819	459	409	—	—	2417	045	331	371	208	186	—	—	1096		
050	790	781	433	437	—	—	2441	050	358	354	196	198	—	—	1107		
055	800	819	470	459	—	—	2548	055	363	372	213	208	—	—	1156		
060	802	820	471	461	—	—	2554	060	364	372	214	209	—	—	1158		
070	1017	1030	862	851	—	—	3759	070	461	467	391	386	—	—	1705		
080	1062	1100	968	935	—	—	4064	080	482	499	439	424	—	—	1843		
090	1035	1153	1018	914	—	—	4119	090	469	523	462	414	—	—	1868		
100	887	911	1179	724	702	1145	5548	100	402	413	535	328	319	519	2517		
115	913	940	1261	813	789	1223	5939	115	414	427	572	369	358	555	2694		
130	1183	1261	1596	763	765	1545	7113	130	537	572	724	346	347	701	3226		
150	1213	1296	1739	871	873	1682	7673	150	550	588	789	395	396	763	3480		

AL/CU COIL, SINGLE PUMP UNITS

30RAP SIZE	POUNDS							Total Weight	30RAP SIZE	KILOGRAMS							Total Weight
	A	B	C	D	E	F	A			B	C	D	E	F			
011	265	254	228	238	—	—	984	011	120	115	104	108	—	—	447		
016	283	262	230	248	—	—	1022	016	128	119	104	113	—	—	464		
018	396	320	288	356	—	—	1360	018	180	145	130	162	—	—	617		
020	398	322	289	358	—	—	1368	020	181	146	131	163	—	—	620		
025	427	346	323	399	—	—	1494	025	194	157	147	181	—	—	678		
030	439	355	331	410	—	—	1535	030	199	161	150	186	—	—	696		
035	732	912	559	448	—	—	2652	035	332	414	254	203	—	—	1203		
040	785	879	533	476	—	—	2674	040	356	399	242	216	—	—	1213		
045	765	953	579	464	—	—	2760	045	347	432	262	211	—	—	1252		
050	824	917	550	494	—	—	2785	050	374	416	250	224	—	—	1263		
055	835	954	588	514	—	—	2892	055	379	433	267	233	—	—	1312		
060	837	955	589	517	—	—	2898	060	380	433	267	234	—	—	1314		
070	1126	1140	954	942	—	—	4161	070	511	517	433	427	—	—	1887		
080	1164	1206	1062	1025	—	—	4457	080	528	547	482	465	—	—	2022		
090	1126	1255	1108	994	—	—	4483	090	511	569	502	451	—	—	2033		
100	1215	982	1098	929	664	1059	5947	100	551	445	498	421	301	480	2697		
115	1240	1012	1178	1019	750	1140	6338	115	562	459	534	462	340	517	2875		
130	1506	1337	1577	901	696	1495	7512	130	683	606	715	409	316	678	3407		
150	1534	1373	1718	1009	804	1634	8072	150	696	623	779	458	365	741	3661		

AL/CU COIL, DUAL PUMP UNITS

30RAP SIZE	POUNDS							Total Weight	30RAP SIZE	KILOGRAMS							Total Weight
	A	B	C	D	E	F	A			B	C	D	E	F			
011	286	315	287	260	—	—	1147	011	130	143	130	118	—	—	520		
016	304	323	288	270	—	—	1185	016	138	147	130	123	—	—	537		
018	425	373	339	386	—	—	1522	018	193	169	154	175	—	—	691		
020	427	375	340	388	—	—	1530	020	194	170	154	176	—	—	694		
025	456	399	374	428	—	—	1657	025	207	181	170	194	—	—	751		
030	468	408	382	439	—	—	1697	030	212	185	173	199	—	—	770		
035	771	1048	678	499	—	—	2995	035	350	475	307	226	—	—	1358		
040	823	1015	651	528	—	—	3017	040	373	461	295	239	—	—	1368		
045	803	1085	699	517	—	—	3104	045	364	492	317	235	—	—	1408		
050	860	1051	670	548	—	—	3129	050	390	477	304	249	—	—	1419		
055	872	1087	708	568	—	—	3235	055	396	493	321	258	—	—	1467		
060	875	1087	709	570	—	—	3241	060	397	493	322	259	—	—	1470		
070	1201	1216	1018	1005	—	—	4441	070	545	552	462	456	—	—	2014		
080	1237	1282	1128	1089	—	—	4737	080	561	581	512	494	—	—	2149		
090	1197	1333	1177	1057	—	—	4763	090	543	605	534	479	—	—	2160		
100	1459	1023	1034	109	622	1004	6232	100	662	464	469	495	282	455	2827		
115	1483	1055	1113	1180	708	1085	6623	115	673	478	505	535	321	492	3004		
130	1744	1383	1565	1005	641	1458	7797	130	791	627	710	456	291	661	3536		
150	1771	1421	1706	1112	750	1597	8357	150	803	645	774	504	340	724	3790		

LEGEND

AL/CU — Aluminum Fin/Copper Tube

NOTES:

1. See Fig. 6 for unit mounting points.

2. 30RAP chillers with Greenspeed® intelligence are not available on unit sizes 070-150.

Table 3 — Unit Operating Weights (Cu/Cu Coil)

CU/CU COIL, NO PUMP UNITS

30RAP SIZE	POUNDS							Total Weight	30RAP SIZE	KILOGRAMS							Total Weight
	A	B	C	D	E	F	A			B	C	D	E	F			
011	242	195	208	258	—	—	903	011	110	88	94	117	—	—	410		
016	261	203	209	268	—	—	941	016	118	92	95	122	—	—	427		
018	367	267	296	407	—	—	1337	018	167	121	134	185	—	—	607		
020	369	269	298	409	—	—	1345	020	167	122	135	186	—	—	610		
025	395	292	349	472	—	—	1508	025	179	132	158	214	—	—	684		
030	407	302	358	482	—	—	1548	030	185	137	162	219	—	—	702		
035	780	873	494	441	—	—	2588	035	354	396	224	200	—	—	1174		
040	841	833	466	470	—	—	2610	040	381	378	211	213	—	—	1184		
045	836	938	526	469	—	—	2769	045	379	426	239	213	—	—	1256		
050	904	894	495	501	—	—	2793	050	410	405	224	227	—	—	1267		
055	910	932	535	522	—	—	2900	055	413	423	243	237	—	—	1315		
060	913	933	536	525	—	—	2906	060	414	423	243	238	—	—	1318		
070	1179	1194	999	987	—	—	4359	070	535	542	453	448	—	—	1977		
080	1250	1294	1140	1100	—	—	4784	080	567	587	517	499	—	—	2170		
090	1216	1354	1196	1073	—	—	4839	090	552	614	542	487	—	—	2195		
100	992	1016	1389	829	808	1354	6388	100	450	461	630	376	366	614	2898		
115	1033	1060	1501	933	909	1463	6899	115	469	481	681	423	412	664	3129		
130	1319	1395	1867	898	900	1814	8193	130	598	633	847	407	408	823	3716		
150	1363	1445	2039	1021	1023	1981	8873	150	618	655	925	463	464	899	4025		

CU/CU COIL, SINGLE PUMP UNITS

30RAP SIZE	POUNDS							Total Weight	30RAP SIZE	KILOGRAMS							Total Weight
	A	B	C	D	E	F	A			B	C	D	E	F			
011	262	257	270	276	—	—	1065	011	119	117	123	125	—	—	483		
016	281	265	271	286	—	—	1103	016	127	120	123	130	—	—	501		
018	397	320	350	433	—	—	1500	018	180	145	159	196	—	—	680		
020	399	322	351	435	—	—	1508	020	181	146	159	197	—	—	684		
025	426	345	403	497	—	—	1670	025	193	156	183	225	—	—	758		
030	438	354	410	508	—	—	1711	030	199	161	186	230	—	—	776		
035	809	1009	618	496	—	—	2932	035	367	458	280	225	—	—	1330		
040	867	971	589	526	—	—	2954	040	393	441	267	239	—	—	1340		
045	862	1074	652	523	—	—	3112	045	391	487	296	237	—	—	1412		
050	928	1033	620	556	—	—	3137	050	421	469	281	252	—	—	1423		
055	936	1071	660	577	—	—	3244	055	425	486	299	262	—	—	1471		
060	939	1071	661	579	—	—	3250	060	426	486	300	263	—	—	1474		
070	1288	1304	1091	1078	—	—	4761	070	584	591	495	489	—	—	2160		
080	1352	1401	1233	1191	—	—	5177	080	613	635	559	540	—	—	2348		
090	1307	1456	1285	1154	—	—	5203	090	593	660	583	524	—	—	2360		
100	1317	1090	1308	1030	773	1268	6787	100	597	494	593	467	351	575	3078		
115	1357	1135	1418	1135	873	1379	7298	115	615	515	643	515	396	626	3310		
130	1639	1474	1846	1035	832	1766	8592	130	743	668	837	469	377	801	3897		
150	1682	1525	2017	1158	955	1935	9272	150	763	692	915	525	433	878	4206		

CU/CU COIL, DUAL PUMP UNITS

30RAP SIZE	POUNDS							Total Weight	30RAP SIZE	KILOGRAMS							Total Weight
	A	B	C	D	E	F	A			B	C	D	E	F			
011	306	337	307	278	—	—	1228	011	139	153	139	126	—	—	557		
016	324	345	307	289	—	—	1266	016	147	157	139	131	—	—	574		
018	464	407	370	421	—	—	1662	018	210	185	168	191	—	—	754		
020	466	409	372	423	—	—	1670	020	211	186	169	192	—	—	758		
025	504	441	414	473	—	—	1833	025	229	200	188	215	—	—	831		
030	517	450	422	484	—	—	1873	030	234	204	191	220	—	—	850		
035	843	1146	741	545	—	—	3275	035	382	520	336	247	—	—	1485		
040	900	1110	711	576	—	—	3297	040	408	503	323	261	—	—	1495		
045	894	1208	778	576	—	—	3456	045	406	548	353	261	—	—	1568		
050	957	1169	745	610	—	—	3481	050	434	530	338	277	—	—	1579		
055	967	1205	785	630	—	—	3587	055	439	547	356	286	—	—	1627		
060	970	1206	786	632	—	—	3593	060	440	547	356	287	—	—	1630		
070	1364	1381	1156	1141	—	—	5041	070	618	626	524	518	—	—	2287		
080	1425	1476	1300	1255	—	—	5457	080	647	670	590	569	—	—	2475		
090	1378	1534	1355	1216	—	—	5483	090	625	696	614	552	—	—	2487		
100	1558	1134	1246	1187	735	1211	7072	100	707	514	565	539	333	549	3208		
115	1597	1181	1356	1291	836	1323	7583	115	724	536	615	586	379	600	3440		
130	1875	1523	1834	1137	778	1730	8877	130	851	691	832	516	353	785	4026		
150	1917	1575	2004	1260	902	1899	9557	150	870	715	909	571	406	861	4335		

LEGEND

CU/CU — Copper Fin/Copper Tube

NOTES:

1. See Fig. 6 for unit mounting points.
2. 30RAP chillers with Greenspeed® intelligence are not available on unit sizes 070-150.

Table 4 — Unit Operating Weights (RTPF AL/CU COIL)

RTPF AL/CU COIL, NO PUMP UNITS

30RAP SIZE	WEIGHT AT MOUNTING POINTS (POUNDS)						
	A	B	C	D	E	F	Total Weight
070	1017	1030	862	851	—	—	3759
080	1062	1100	968	935	—	—	4064
090	1035	1153	1018	914	—	—	4119
100	887	911	1179	724	702	1145	5548
115	913	940	1261	813	789	1223	5939
130	1183	1261	1596	763	765	1545	7113
150	1213	1296	1739	871	873	1682	7673

30RAP SIZE	WEIGHT AT MOUNTING POINTS (KILOGRAMS)						
	A	B	C	D	E	F	Total Weight
070	461	467	391	386	—	—	1705
080	482	499	439	424	—	—	1843
090	469	523	462	414	—	—	1868
100	402	413	535	328	319	519	2517
115	414	427	572	369	358	555	2694
130	537	572	724	346	347	701	3226
150	550	588	789	395	396	763	3480

RTPF AL/CU COIL, SINGLE PUMP UNITS

30RAP SIZE	POUNDS						
	A	B	C	D	E	F	Total Weight
070	1126	1140	954	942	—	—	4161
080	1164	1206	1062	1025	—	—	4457
090	1126	1255	1108	994	—	—	4483
100	1215	982	1098	929	664	1059	5947
115	1240	1012	1178	1019	750	1140	6338
130	1506	1337	1577	901	696	1495	7512
150	1534	1373	1718	1009	804	1634	8072

30RAP SIZE	KILOGRAMS						
	A	B	C	D	E	F	Total Weight
070	511	517	433	427	—	—	1887
080	528	547	482	465	—	—	2022
090	511	569	502	451	—	—	2033
100	551	445	498	421	301	480	2697
115	562	459	534	462	340	517	2875
130	683	606	715	409	316	678	3407
150	696	623	779	458	365	741	3661

RTPF AL/CU COIL, DUAL PUMP UNITS

30RAP SIZE	POUNDS						
	A	B	C	D	E	F	Total Weight
070	1201	1216	1018	1005	—	—	4441
080	1237	1282	1128	1089	—	—	4737
090	1197	1333	1177	1057	—	—	4763
100	1459	1023	1034	109	622	1004	6232
115	1483	1055	1113	1180	708	1085	6623
130	1744	1383	1565	1005	641	1458	7797
150	1771	1421	1706	1112	750	1597	8357

30RAP SIZE	KILOGRAMS						
	A	B	C	D	E	F	Total Weight
070	545	552	462	456	—	—	2014
080	561	581	512	494	—	—	2149
090	543	605	534	479	—	—	2160
100	662	464	469	495	282	455	2827
115	673	478	505	535	321	492	3004
130	791	627	710	456	291	661	3536
150	803	645	774	504	340	724	3790

LEGEND

CU/CU — Copper Fin/Copper Tube

NOTES:

1. See Fig. 6 for unit mounting points.
2. 30RAP chillers with Greenspeed® intelligence are not available on unit sizes 070-150.



Table 5 — Unit Operating Weights (RTPF CU/CU COIL)

RTPF CU/CU COIL, NO PUMP UNITS

30RAP SIZE	WEIGHT AT MOUNTING POINTS (POUNDS)							Total Weight	30RAP SIZE	WEIGHT AT MOUNTING POINTS (KILOGRAMS)							Total Weight
	A	B	C	D	E	F	A			B	C	D	E	F			
070	1179	1194	999	987	—	—	4359	070	535	542	453	448	—	—	1977		
080	1250	1294	1140	1100	—	—	4784	080	567	587	517	499	—	—	2170		
090	1216	1354	1196	1073	—	—	4839	090	552	614	542	487	—	—	2195		
100	992	1016	1389	829	808	1354	6388	100	450	461	630	376	366	614	2898		
115	1033	1060	1501	933	909	1463	6899	115	469	481	681	423	412	664	3129		
130	1319	1395	1867	898	900	1814	8193	130	598	633	847	407	408	823	3716		
150	1363	1445	2039	1021	1023	1981	8873	150	618	655	925	463	464	899	4025		

RTPF CU/CU COIL, SINGLE PUMP UNITS

30RAP SIZE	POUNDS							Total Weight	30RAP SIZE	KILOGRAMS							Total Weight
	A	B	C	D	E	F	A			B	C	D	E	F			
070	1288	1304	1091	1078	—	—	4761	070	584	591	495	489	—	—	2160		
080	1352	1401	1233	1191	—	—	5177	080	613	635	559	540	—	—	2348		
090	1307	1456	1285	1154	—	—	5203	090	593	660	583	524	—	—	2360		
100	1317	1090	1308	1030	773	1268	6787	100	597	494	593	467	351	575	3078		
115	1357	1135	1418	1135	873	1379	7298	115	615	515	643	515	396	626	3310		
130	1639	1474	1846	1035	832	1766	8592	130	743	668	837	469	377	801	3897		
150	1682	1525	2017	1158	955	1935	9272	150	763	692	915	525	433	878	4206		

RTPF CU/CU COIL, DUAL PUMP UNITS

30RAP SIZE	POUNDS							Total Weight	30RAP SIZE	KILOGRAMS							Total Weight
	A	B	C	D	E	F	A			B	C	D	E	F			
070	1364	1381	1156	1141	—	—	5041	070	618	626	524	518	—	—	2287		
080	1425	1476	1300	1255	—	—	5457	080	647	670	590	569	—	—	2475		
090	1378	1534	1355	1216	—	—	5483	090	625	696	614	552	—	—	2487		
100	1558	1134	1246	1187	735	1211	7072	100	707	514	565	539	333	549	3208		
115	1597	1181	1356	1291	836	1323	7583	115	724	536	615	586	379	600	3440		
130	1875	1523	1834	1137	778	1730	8877	130	851	691	832	516	353	785	4026		
150	1917	1575	2004	1260	902	1899	9557	150	870	715	909	571	406	861	4335		

LEGEND

CU/CU — Copper Fin/Copper Tube

NOTES:

1. See Fig. 6 for unit mounting points.
2. 30RAP chillers with Greenspeed® intelligence are not available on unit sizes 070-150.

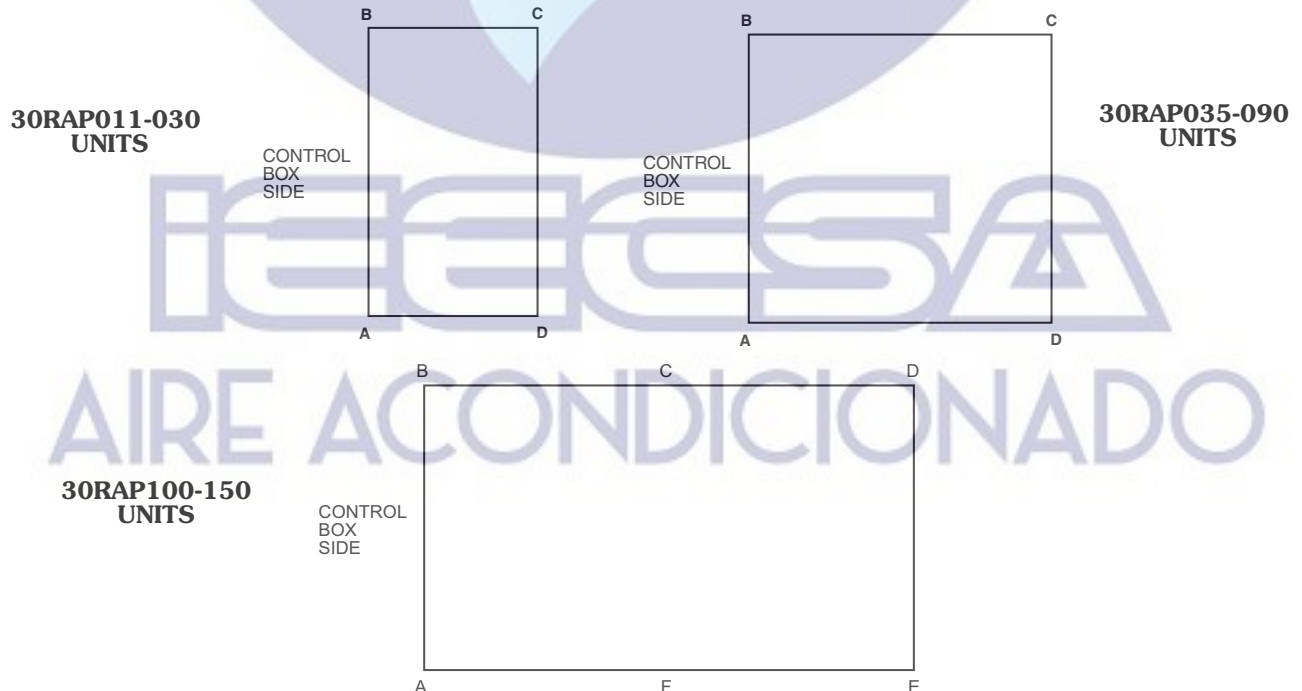

Fig. 6 — Unit Mounting Points

Table 6 — Physical Data, 30RAP — English

UNIT 30RAP	011	016	018	020	025
OPERATING WEIGHT (lb)					
MCHX Condenser Coil, No Pump	762	800	1125	1133	1242
MCHX Condenser Coil, Single Pump (60 Hz only)	925	963	1288	1296	1405
MCHX Condenser Coil, Dual Pump (60 Hz only)	1087	1125	1450	1458	1567
Al-Cu Condenser Coil, No Pump	822	860	1197	1205	1332
Al-Cu Condenser Coil, Single Pump (60 Hz only)	985	1023	1360	1368	1495
Al-Cu Condenser Coil, Dual Pump (60 Hz only)	1147	1185	1522	1530	1657
Cu-Cu Condenser Coil, No Pump	903	941	1337	1345	1508
Cu-Cu Condenser Coil, Single Pump (60 Hz only)	1066	1104	1500	1508	1671
Cu-Cu Condenser Coil, Dual Pump (60 Hz only)	1228	1266	1662	1670	1833
REFRIGERANT TYPE					
R-410A, EXV Controlled System					
Total Refrigerant Charge MCHX (lb)	8.3	9.3	14.6	15.2	16.7
Refrigerant Charge MCHX (lb) Ckt A/Ckt B	8.3/—	9.3/—	14.6/—	15.2/—	16.7/—
Total Refrigerant Charge RTPF (lb)	20.3	21.3	31.0	31.6	36.9
Refrigerant Charge RTPF (lb) Ckt A/Ckt B	20.3/—	21.3/—	31.0/—	31.6/—	36.9/—
COMPRESSORS					
Scroll, Hermetic					
Quantity	2	2	2	2	2
Speed (Rpm)	3500 (60 Hz)/2900 (50 Hz)				
(Qty) Tons, Ckt A	(2) 6/4	(2) 9/6	(2) 9	(2) 10	(2) 13
(Qty) Tons, Ckt B	—	—	—	—	—
Oil Charge (Pt) Ckt A/Ckt B	6.4/—	9.1/—	13.8/—	13.8/—	13.8/—
No. Capacity Steps					
Standard	3	3	2	2	2
With Hot Gas Bypass	—	—	3	3	3
Digital Compressor Option	21	21	22	22	22
Minimum Capacity Step (%)					
Standard	40	40	50	50	50
With Hot Gas Bypass	—	—	20	24	29
Digital Compressor Option	20	20	17	17	17
Capacity (%)					
Circuit A	100	100	100	100	100
Circuit B	—	—	—	—	—
COOLER					
Braze, Direct-Expansion Plate Heat Exchanger					
Weight (lb) (empty)	22.4	31.8	31.8	40.3	46.3
Net Fluid Volume (gal)	0.6	0.9	0.9	1.2	1.4
Maximum Refrigerant Pressure (psig)	505	505	505	505	505
Maximum Water-Side Pressure Without Pump(s) (psig)	300	300	300	300	300
Maximum Water-Side Pressure With Pump(s) (psig)	150	150	150	150	150
CHILLER WATER CONNECTIONS (in.)					
Inlet and Outlet, Victaulic (IPS Carbon Steel)*	2	2	2	2	2
Drain (NPT)	1/4	1/4	1/4	1/4	1/4
CONDENSER FANS					
Standard Low-Sound AeroAcoustic™ Type					
Plastic Type, Axial, Vertical Discharge					
Fan Speed (Rpm)	850 (60 Hz)/710 (50 Hz)				
No. Blades...Diameter (in.)	9...30	9...30	9...30	9...30	9...30
No. Fans	1	1	2	2	2
Total Airflow 60 Hz (Cfm)	9400	9400	17,500	17,500	19,400
Total Airflow 50 Hz (Cfm)	7849	7849	14,613	14,613	16,199
Optional Value Sound Type					
Propeller Type, Axial, Vertical Discharge					
1140 (60 Hz)/950 (50 Hz)					
Fan Speed (Rpm)	4...30	4...30	4...30	4...30	4...30
No. Blades...Diameter (in.)	4...30	4...30	4...30	4...30	4...30
No. Fans	1	1	2	2	2
Total Airflow 60 Hz (Cfm)	10,100	10,100	18,500	18,500	20,900
Total Airflow 50 Hz (Cfm)	8434	8434	15,448	15,448	17,452
CONDENSER COILS					
Novation® MCHX Aluminum Tube, Aluminum Fin					
Quantity (Ckt A/Ckt B)	1/—	1/—	1/—	1/—	1/—
Total Face Area (sq ft)	19	19	26	26	33
Maximum Refrigerant Pressure (psig)	656	656	656	656	656
HYDRONIC MODULE (Optional, 60 Hz only)†					
Pump(s), Strainer with Blowdown Valve, Expansion Tank, Pressure Taps, Drain and Vent Plugs, Flow Switch, and Balance Valve					
Single or Dual, Centrifugal Monocell Pump(s), 3500 Rpm. Dual pumps with check valves and isolation valves.					
Pump					
Expansion Tank Volume (gal) Total/Acceptance	4.4/3.2				
CHASSIS DIMENSIONS (ft - in.)					
Length	5-7	5-7	7-5	7-5	7-5
Width	3-5	3-5	3-5	3-5	3-5
Height	5-6	5-6	5-6	5-6	6-6

LEGEND

EXV — Electronic Expansion Valve
MCHX — Microchannel Heat Exchanger
RTPF — Round Tube, Plate Fin (Condenser Coil)

*Unit connection is IPS Carbon Steel piping.
†Flow switch and strainer are standard on all units, with or without hydronic package.
NOTE: 30RAP chillers with Greenspeed intelligence are not available on unit sizes 070-150.

Table 6 — Physical Data, 30RAP — English (cont)

UNIT 30RAP	030	035	040	045	050	055	060
OPERATING WEIGHT (lb)							
MCHX Condenser Coil, No Pump	1283	2163	2185	2238	2263	2369	2375
MCHX Condenser Coil, Single Pump (60 Hz only)	1446	2507	2529	2582	2606	2713	2719
MCHX Condenser Coil, Dual Pump (60 Hz only)	1608	2850	2872	2925	2950	3056	3062
Al-Cu Condenser Coil, No Pump	1372	2308	2330	2417	2442	2548	2554
Al-Cu Condenser Coil, Single Pump (60 Hz only)	1535	2652	2674	2761	2785	2892	2898
Al-Cu Condenser Coil, Dual Pump (60 Hz only)	1697	2995	3017	3104	3129	3235	3241
Cu-Cu Condenser Coil, No Pump	1548	2588	2610	2769	2794	2900	2906
Cu-Cu Condenser Coil, Single Pump (60 Hz only)	1711	2932	2954	3113	3137	3244	3250
Cu-Cu Condenser Coil, Dual Pump (60 Hz only)	1873	3275	3297	3456	3481	3587	3593
REFRIGERANT TYPE							
Total Refrigerant Charge MCHX (lb)	19.0	31.0	31.4	34.6	36.6	37.0	37.0
Refrigerant Charge MCHX (lb) Ckt A/Ckt B	19.0/—	15.5/15.5	15.6/15.8	17.3/17.3	18.2/18.4	18.5/18.5	18.5/18.5
Total Refrigerant Charge RTPF (lb)	39.3	63.4	63.8	70.6	72.6	73.0	73.0
Refrigerant Charge RTPF (lb) Ckt A/Ckt B	39.3/—	31.7/31.7	31.8/32.0	35.3/35.3	36.2/36.4	36.5/36.5	36.5/36.5
COMPRESSORS							
Quantity	2	4	4	4	4	4	4
Speed (Rpm)			3500	3500	3500	3500	3500
(Qty) Tons, Ckt A	(2) 15	(2) 10	(2) 10	(2) 11	(2) 13	(2) 13	(2) 15
(Qty) Tons, Ckt B	—	(2) 9	(2) 11	(2) 13	(2) 13	(2) 15	(2) 15
Oil Charge (Pt) Ckt A/Ckt B	13.8/—	13.8/13.8	13.8/13.8	13.8/13.8	13.8/13.8	13.8/13.8	13.8/13.8
No. Capacity Steps							
Standard	2	4	4	4	4	4	4
With Hot Gas Bypass	3	5	5	5	5	5	5
Digital Compressor Option	22	44	44	44	44	44	44
Minimum Capacity Step (%)							
Standard	50	23	23	24	25	23	25
With Hot Gas Bypass	32	9	11	12	14	13	16
Digital Compressor Option	17	9	8	8	8	8	8
Capacity (%)							
Circuit A	100	54	47	47	50	46	50
Circuit B	—	46	53	53	50	54	50
COOLER							
Weight (lb) (empty)	99.3	98	109	117	129	140	140
Net Fluid Volume (gal)	2.62	3.4	3.9	4.2	4.6	5.2	5.2
Maximum Refrigerant Pressure (psig)	565	565	565	565	565	565	565
Maximum Water-Side Pressure Without Pump(s) (psig)	300	300	300	300	300	300	300
Maximum Water-Side Pressure With Pump(s) (psig)	150	150	150	150	150	150	150
CHILLER WATER CONNECTIONS (in.)							
Inlet and Outlet, Victaulic (IPS Carbon Steel)*	2	2½	2½	2½	2½	2½	2½
Drain (NPT)	¼	¼	¼	¼	¼	¼	¼
CONDENSER FANS							
Standard Low-Sound AeroAcoustic™ Type							
Fan Speed (Rpm)				850 (60 Hz)/710 (50 Hz)			
No. Blades...Diameter (in.)	9...30	9...30	9...30	9...30	9...30	9...30	9...30
No. Fans	2	3	3	3	3	4	4
Total Airflow 60 Hz (Cfm)	19,400	29,600	29,600	30,500	30,500	38,800	38,800
Total Airflow 50 Hz (Cfm)	16,199	24,716	24,716	25,468	25,468	32,398	32,398
Optional Value Sound Type							
Fan Speed (Rpm)				1140 (60 Hz)/950 (50 Hz)			
No. Blades...Diameter (in.)	4...30	4...30	4...30	4...30	4...30	4...30	4...30
No. Fans	2	3	3	3	3	4	4
Total Airflow 60 Hz (Cfm)	20,900	32,000	32,000	33,300	33,300	41,800	41,800
Total Airflow 50 Hz (Cfm)	17,452	26,720	26,720	27,805	27,805	34,903	34,903
CONDENSER COILS							
Quantity (Ckt A/Ckt B)	1/—	1/1	1/1	1/1	1/1	1/1	1/1
Total Face Area (sq ft)	33	53	53	66	66	66	66
Maximum Refrigerant Pressure (psig)	656	656	656	656	656	656	656
HYDRONIC MODULE (Optional, 60 Hz only)†							
Pump	Pump(s), Strainer with Blowdown Valve, Expansion Tank, Pressure Taps, Drain and Vent Plugs, Flow Switch, and Balance Valve						
Expansion Tank Volume (gal)	Single or Dual, Centrifugal Monocell Pump(s), 3500 Rpm. Dual pumps with check valves and isolation valves.						
Total/Acceptance	4.4/3.2			10.3/10.3			
CHASSIS DIMENSIONS (ft - in.)							
Length	7-5	7-5	7-5	7-5	7-5	7-5	7-5
Width	3-5	7-9	7-9	7-9	7-9	7-9	7-9
Height	6-6	5-6	5-6	6-6	6-6	6-6	6-6

LEGEND

EXV — Electronic Expansion Valve
MCHX — Microchannel Heat Exchanger
RTPF — Round Tube, Plate Fin (Condenser Coil)

*Unit connection is IPS Carbon Steel piping.
†Flow switch and strainer are standard on all units, with or without hydronic package.
NOTE: 30RAP chillers with Greenspeed intelligence are not available on unit sizes 070-150.

Table 6 — Physical Data, 30RAP — English (cont)

UNIT 30RAP	070	080	090	100	115	130	150
OPERATING WEIGHT (lb)							
MCHX Condenser Coil, No Pump	3410	3641	3697	4690	5008	6451	6938
MCHX Condenser Coil, Single Pump (60 Hz only)	3812	4035	4061	5089	5407	6850	7337
MCHX Condenser Coil, Dual Pump (60 Hz only)	4092	4390	4411	5374	5692	7135	7622
Al-Cu Condenser Coil, No Pump	3759	4064	4119	5548	5939	7113	7673
Al-Cu Condenser Coil, Single Pump (60 Hz only)	4161	4457	4483	5947	6338	7512	8072
Al-Cu Condenser Coil, Dual Pump (60 Hz only)	4441	4737	4763	6232	6623	7797	8357
Cu-Cu Condenser Coil, No Pump	4359	4784	4839	6388	6899	8193	8873
Cu-Cu Condenser Coil, Single Pump (60 Hz only)	4761	5177	5203	6787	7298	8592	9272
Cu-Cu Condenser Coil, Dual Pump (60 Hz only)	5041	5457	5483	7072	7583	8877	9557
REFRIGERANT TYPE							
R-410A, EXV Controlled System							
Total Refrigerant Charge MCHX (lb)	60.5	70.2	71.0	88.3	100.9	110.4	119.5
Refrigerant Charge MCHX (lb) Ckt A/Ckt B	25.5/35	35.1/35.1	35.5/35.5	39.3/49.0	50.6/50.3	51.2/59.2	60.0/59.5
Total Refrigerant Charge RTPF (lb)	150.0	169.2	170.0	192.0	213.0	239.2	264.0
Refrigerant Charge RTPF (lb) Ckt A/Ckt B	65.5/84.5	84.6/84.6	85.0/85.0	87.0/105.0	106.5/106.5	107.5/131.7	132.0/132.0
COMPRESSORS							
Scroll, Hermetic							
Quantity	5	6	6	5	6	6	6
Speed (Rpm)	3500 (60 Hz)/ 2900 (50Hz)						
(Qty, Tons) Ckt A	(2) 15	(3) 13	(3) 15	(1) 20 (1) 25	(3) 20	(3) 20	(3) 25
(Qty, Tons) Ckt B	(3) 15	(3) 15	(3) 15	(3) 20	(3) 20	(3) 25	(3) 25
Oil Charge (Pt) Ckt A/Ckt B	13.8/20.6	20.6/20.6	20.6/20.6	28.4/42.6	42.6/42.6	42.6/42.6	42.6/42.6
No. Capacity Steps							
Standard	5	6	6	5	6	6	6
With Hot Gas Bypass	6	7	7	6	7	7	7
Digital Compressor Option	55	66	66	—	—	—	—
Minimum Capacity Step (%)							
Standard	20	15	17	19	17	15	17
With Hot Gas Bypass	13	9	11	13	11	9	11
Digital Compressor Option	7	5	6	—	—	—	—
Capacity (%)							
Circuit A	40	46	50	43	50	44	50
Circuit B	60	54	50	57	50	56	50
COOLER							
Braze, Direct-Expansion Plate Heat Exchanger							
Weight (lb) (empty)	197	228	245	267	304	334	378
Net Fluid Volume (gal)	4.3	5.0	6.8	7.4	8.6	9.5	10.9
Maximum Refrigerant Pressure (psig)	450	450	450	450	450	450	450
Maximum Water-Side Pressure Without Pump(s) (psig)	300	300	300	300	300	300	300
Maximum Water-Side Pressure With Pump(s) (psig)	150	150	150	150	150	150	150
CHILLER WATER CONNECTIONS (in.)							
Inlet and Outlet, Victaulic (IPS Carbon Steel)*	3	3	3	4	4	4	4
Drain (NPT)	1/4	1/4	1/4	1/4	1/4	1/4	1/4
CONDENSER FANS							
Standard Low-Sound AeroAcoustic™ Type							
Plastic Type, Axial, Vertical Discharge							
Fan Speed (Rpm)	850 (60 Hz)/710 (50 Hz)						
No. Blades...Diameter (in.)	9...30	9...30	9...30	9...30	9...30	9...30	9...30
No. Fans	5	6	6	7	8	9	10
Total Airflow, 60 Hz (Cfm)	48,500	58,200	58,200	67,900	77,600	87,300	97,000
Total Airflow, 50 Hz (Cfm)	40,512	48,614	48,614	56,716	64,819	72,921	81,024
Optional Value Sound Type							
Propeller Type, Axial, Vertical Discharge							
Fan Speed (Rpm)	1140 (60 Hz)/950 (50 Hz)						
No. Blades...Diameter (in.)	4...30	4...30	4...30	4...30	4...30	4...30	4...30
No. Fans	5	6	6	7	8	9	10
Total Airflow, 60 Hz (Cfm)	51,250	61,500	61,500	71,750	82,000	92,250	102,500
Total Airflow, 50 Hz (Cfm)	42,809	51,371	51,371	59,932	68,494	77,056	85,618
CONDENSER COILS							
Novation® MCHX Aluminum Tube, Aluminum Fin or RTPF							
Quantity (Ckt A/Ckt B)	2/3	3/3	3/3	3/4	4/4	4/5	5/5
Total Face Area (sq ft)	124.7	149.6	149.6	174.5	199.4	224.4	249.3
Maximum Refrigerant Pressure (psig)	656	656	656	656	656	656	656
HYDRONIC MODULE (Optional, 60 Hz Only)†							
Pump(s), Strainer with Blowdown Valve, Expansion Tank, Pressure Taps, Drain and Vent Plugs, Flow Switch, and Balance Valve							
Pump	Single or Dual, Centrifugal Monocell Pump(s), 3500 Rpm. Dual pumps with check valves and isolation valves.						
Expansion Tank Volume (gal) Total/Acceptance	—	—	—	—	—	—	—
CHASSIS DIMENSIONS (ft - in.)							
Length	12-7	12-7	12-7	15-11	15-11	19-4	19-4
Width	7-4	7-4	7-4	7-4	7-4	7-4	7-4
Height	6-6	6-6	6-6	6-6	6-6	6-6	6-6

*Unit connection is IPS Carbon Steel piping.

†Flow switch and strainer are standard on all units, with or without hydronic package.

NOTE: 30RAP chillers with Greenspeed intelligence are not available on unit sizes 070-150.

LEGEND

- EXV — Electronic Expansion Valve
- MCHX — Microchannel Heat Exchanger
- RTPF — Round Tube, Plate Fin (Condenser Coil)

Table 7 — Physical Data, 30RAP — SI

UNIT 30RAP	011	016	018	020	025
OPERATING WEIGHT (kg)					
MCHX Condenser Coil, No Pump	346	363	510	514	564
MCHX Condenser Coil, Single Pump (60 Hz only)	419	437	584	588	637
MCHX Condenser Coil, Dual Pump (60 Hz only)	493	510	658	661	711
Al-Cu Condenser Coil, No Pump	373	390	543	547	604
Al-Cu Condenser Coil, Single Pump (60 Hz only)	447	464	617	621	678
Al-Cu Condenser Coil, Dual Pump (60 Hz only)	520	538	691	694	751
Cu-Cu Condenser Coil, No Pump	410	427	606	610	684
Cu-Cu Condenser Coil, Single Pump (60 Hz only)	484	501	680	684	758
Cu-Cu Condenser Coil, Dual Pump (60 Hz only)	557	574	754	757	831
REFRIGERANT TYPE					
	R-410A, EXV Controlled System				
Total Refrigerant Charge MCHX (kg)	3.8	4.2	6.6	7.1	7.6
Refrigerant Charge MCHX (kg) Ckt A/Ckt B	3.8/—	4.2/—	6.6/—	7.1/—	7.6/—
Total Refrigerant Charge RTPF (kg)	9.2	9.6	14.0	14.3	16.7
Refrigerant Charge RTPF (kg) Ckt A/Ckt B	9.2/--	9.6/--	14.0/--	14.3/--	16.7/--
COMPRESSORS					
	Scroll, Hermetic				
Quantity	2	2	2	2	2
Speed (R/s)	58.3 (60 Hz)/48.3 (50 Hz)				
(Qty) kW, Ckt A	(2) 21/14	(2) 31/21	(2) 32	(2) 35	(2) 46
(Qty) kW, Ckt B	—	—	—	—	—
Oil Charge (L) Ckt A/Ckt B	3/—	4.3/—	6.5/—	6.5/—	6.5/—
No. Capacity Steps					
Standard	3	3	2	2	2
With Hot Gas Bypass	—	—	3	3	3
Digital Compressor Option	21	21	22	22	22
Minimum Capacity Step (%)					
Standard	40	40	50	50	50
With Hot Gas Bypass	—	—	20	24	29
Digital Compressor Option	20	20	17	17	17
Capacity (%)					
Circuit A	100	100	100	100	100
Circuit B	—	—	—	—	—
COOLER					
	Brazed, Direct-Expansion Plate Heat Exchanger				
Weight (kg) (empty)	10.1	14.4	14.4	18.3	21.0
Net Fluid Volume (L)	2.3	3	3.4	4.5	5.3
Maximum Refrigerant Pressure (kPa)	3482	3482	3482	3482	3482
Maximum Water-Side Pressure Without Pump(s) (kPa)	2068	2068	2068	2068	2068
Maximum Water-Side Pressure With Pump(s) (kPa)	1034	1034	1034	1034	1034
CHILLER WATER CONNECTIONS (in.)					
Inlet and Outlet, Victaulic (IPS Carbon Steel)*	2	2	2	2	2
Drain (NPT)	1/4	1/4	1/4	1/4	1/4
CONDENSER FANS					
	Standard Low-Sound AeroAcoustic™ Type				
	Plastic Type, Axial, Vertical Discharge				
Fan Speed (R/s)	14.2 (60 Hz)/11.8 (50 Hz)				
No. Blades...Diameter (mm)	9...762	9...762	9...762	9...762	9...762
No. Fans	1	1	2	2	2
Total Airflow 60 Hz (L/s)	4437	4437	8260	8260	9157
Total Airflow 50 Hz (L/s)	3705	3705	6897	6897	7646
Optional Value Sound Type	Propeller Type, Axial, Vertical Discharge				
Fan Speed (R/s)	19.0 (60 Hz)/15.8 (50 Hz)				
No. Blades...Diameter (mm)	4...762	4...762	4...762	4...762	4...762
No. Fans	1	1	2	2	2
Total Airflow 60 Hz (L/s)	4800	4800	8732	8732	9865
Total Airflow 50 Hz (L/s)	3981	3981	7291	7291	8237
CONDENSER COILS					
	Novation® MCHX Aluminum Tube, Aluminum Fin				
Quantity (Ckt A/Ckt B)	1/—	1/—	1/—	1/—	1/—
Total Face Area (sq m)	1.8	1.8	2.4	2.4	3.1
Maximum Refrigerant Pressure (kPa)	4523	4523	4523	4523	4523
HYDRONIC MODULE (Optional, 60 Hz Only)†					
	Pump(s), Strainer with Blowdown Valve, Expansion Tank, Pressure Taps, Drain and Vent Plugs, Flow Switch, and Balance Valve				
Pump	Single or Dual, Centrifugal Monocell Pump(s), 3500 Rpm. Dual pumps with check valves and isolation valves.				
Expansion Tank Volume (L) Total/Acceptance	17.4/12.3				
CHASSIS DIMENSIONS (mm)					
Length	1689	1689	2242	2242	2242
Width	1029	1029	1025	1025	1025
Height	1689	1689	1689	1689	1994

LEGEND

EXV — Electronic Expansion Valve
MCHX — Microchannel Heat Exchanger
RTPF — Round Tube, Plate Fin (Condenser Coil)

*Unit connection is IPS Carbon Steel piping.

†Flow switch and strainer are standard on all units, with or without hydronic package.

NOTE: 30RAP chillers with Greenspeed intelligence are not available on unit sizes 070-150.

Table 7 — Physical Data, 30RAP — SI (cont)

UNIT 30RAP	030	035	040	045	050	055	060
OPERATING WEIGHT (kg)							
MCHX Condenser Coil, No Pump	582	981	991	1015	1026	1075	1077
MCHX Condenser Coil, Single Pump (60 Hz only)	656	1137	1147	1171	1182	1231	1233
MCHX Condenser Coil, Dual Pump (60 Hz only)	729	1293	1303	1327	1338	1386	1389
Al-Cu Condenser Coil, No Pump	623	1047	1057	1096	1108	1156	1159
Al-Cu Condenser Coil, Single Pump (60 Hz only)	696	1203	1213	1252	1263	1312	1315
Al-Cu Condenser Coil, Dual Pump (60 Hz only)	770	1358	1368	1408	1419	1467	1470
Cu-Cu Condenser Coil, No Pump	702	1174	1184	1256	1267	1316	1318
Cu-Cu Condenser Coil, Single Pump (60 Hz only)	776	1330	1340	1412	1423	1472	1474
Cu-Cu Condenser Coil, Dual Pump (60 Hz only)	850	1485	1495	1568	1579	1627	1630
REFRIGERANT TYPE							
Total Refrigerant Charge MCHX (kg)	8.6	14.1	14.3	15.7	16.6	16.8	16.8
Refrigerant Charge MCHX (kg) Ckt A/Ckt B	8.6/—	7.0/7.0	7.1/7.2	7.9/7.9	8.3/8.4	8.4/8.4	8.4/8.4
Total Refrigerant Charge RTPF (kg)	17.8	28.8	28.9	32.0	32.9	33.1	33.1
Refrigerant Charge RTPF (kg) Ckt A/Ckt B	17.8/--	14.4/14.4	14.4/14.5	16.0/16.0	16.4/16.5	16.6/16.6	16.6/16.6
COMPRESSORS							
Quantity	2	4	4	4	4	4	4
Speed (R/s)				58.3			
(Qty) kW, Ckt A	(2) 53	(2) 35	(2) 35	(2) 38	(2) 46	(2) 46	(2) 53
(Qty) kW, Ckt B	—	(2) 32	(2) 38	(2) 46	(2) 46	(2) 53	(2) 53
Oil Charge (L) Ckt A/Ckt B	6.5/—	6.5/6.5	6.5/6.5	6.5/6.5	6.5/6.5	6.5/6.5	6.5/6.5
No. Capacity Steps							
Standard	2	4	4	4	4	4	4
With Hot Gas Bypass	3	5	5	5	5	5	5
Digital Compressor Option	22	44	44	44	44	44	44
Minimum Capacity Step (%)							
Standard	50	23	23	24	25	23	25
With Hot Gas Bypass	32	9	11	12	14	13	16
Digital Compressor Option	17	9	8	8	8	8	8
Capacity (%)							
Circuit A	100	54	47	47	50	46	50
Circuit B	—	46	53	53	50	54	50
COOLER							
Weight (kg) (empty)	45	44.5	49.5	53.2	58.6	63.6	63.6
Net Fluid Volume (L)	9.9	12.9	14.8	15.9	17.4	19.7	19.7
Maximum Refrigerant Pressure (kPa)	3896	3896	3896	3896	3896	3896	3896
Maximum Water-Side Pressure Without Pump(s) (kPa)	2068	2068	2068	2068	2068	2068	2068
Maximum Water-Side Pressure With Pump(s) (kPa)	1034	1034	1034	1034	1034	1034	1034
CHILLER WATER CONNECTIONS (in.)							
Inlet and Outlet, Victaulic (IPS Carbon Steel)*	2	2½	2½	2½	2½	2½	2½
Drain (NPT)	¼	¼	¼	¼	¼	¼	¼
CONDENSER FANS							
Standard Low-Sound AeroAcoustic™ Type							
Fan Speed (R/s)				14.2 (60 Hz)/11.8 (50 Hz)			
No. Blades...Diameter (mm)	9...762	9...762	9...762	9...762	9...762	9...762	9...762
No. Fans	2	3	3	3	3	4	4
Total Airflow 60 Hz (L/s)	9157	13 971	13 971	14 396	14 396	18 314	18 314
Total Airflow 50 Hz (L/s)	7646	11 666	11 666	12 021	12 021	15 292	15 292
Optional Value Sound Type							
Propeller Type, Axial, Vertical Discharge				19.0 (60 Hz)/15.8 (50 Hz)			
Fan Speed (R/s)							
No. Blades...Diameter (mm)	4...762	4...762	4...762	4...762	4...762	4...762	4...762
No. Fans	2	3	3	3	3	4	4
Total Airflow 60 Hz (L/s)	9865	15 104	15 104	15 718	15 718	19 730	19 730
Total Airflow 50 Hz (L/s)	8237	12 612	12 612	13 124	13 124	16 474	16 474
CONDENSER COILS							
Quantity (Ckt A/Ckt B)	1/—	1/1	1/1	1/1	1/1	1/1	1/1
Total Face Area (sq m)	3.1	4.9	4.9	6.1	6.1	6.1	6.1
Maximum Refrigerant Pressure (kPa)	4523	4523	4523	4523	4523	4523	4523
HYDRONIC MODULE (Optional, 60 Hz Only)†							
Pump	Pump(s), Strainer with Blowdown Valve, Expansion Tank, Pressure Taps, Drain and Vent Plugs, Flow Switch, and Balance Valve						
Expansion Tank Volume (L)	Single or Dual, Centrifugal Monocell Pump(s), 3500 Rpm. Dual pumps with check valves and isolation valves.						
Total/Acceptance	17.4/12.3			39.0/39.0			
CHASSIS DIMENSIONS (mm)							
Length	2242	2248	2248	2248	2248	2248	2248
Width	1025	2350	2350	2350	2350	2350	2350
Height	1994	1689	1689	1994	1994	1994	1994

LEGEND

- EXV — Electronic Expansion Valve
- MCHX — Microchannel Heat Exchanger
- RTPF — Round Tube, Plate Fin (Condenser Coil)

*Unit connection is IPS Carbon Steel piping.

†Flow switch and strainer are standard on all units, with or without hydronic package.

NOTE: 30RAP chillers with Greenspeed intelligence are not available on unit sizes 070-150.

Table 7 — Physical Data, 30RAP — SI (cont)

UNIT 30RAP	070	080	090	100	115	130	150
OPERATING WEIGHT (kg)							
MCHX Condenser Coil, No Pump	1547	1652	1677	2127	2272	2926	3147
MCHX Condenser Coil, Single Pump (60 Hz only)	1729	1830	1842	2308	2453	3107	3328
MCHX Condenser Coil, Dual Pump (60 Hz only)	1856	1991	2001	2438	2582	3236	3457
Al-Cu Condenser Coil, No Pump	1705	1843	1868	2517	2694	3226	3480
Al-Cu Condenser Coil, Single Pump (60 Hz only)	1887	2022	2033	2698	2875	3407	3661
Al-Cu Condenser Coil, Dual Pump (60 Hz only)	2014	2149	2160	2827	3004	3537	3791
Cu-Cu Condenser Coil, No Pump	1977	2170	2195	2898	3129	3716	4025
Cu-Cu Condenser Coil, Single Pump (60 Hz only)	2160	2348	2360	3079	3310	3897	4206
Cu-Cu Condenser Coil, Dual Pump (60 Hz only)	2287	2475	2487	3208	3440	4027	4335
REFRIGERANT TYPE							
	R-410A, EXV Controlled System						
Total Refrigerant Charge MCHX (kg)	27.5	31.8	32.2	40.1	45.8	50.1	54.2
Refrigerant Charge MCHX (kg) Ckt A/Ckt B	11.6/15.9	15.9/15.9	16.1/16.1	17.8/22.3	23.0/22.8	23.2/26.9	27.2/27.0
Total Refrigerant Charge RTPF (kg)	68.0	76.8	77.2	87.1	96.6	108.5	119.8
Refrigerant Charge RTPF (kg) Ckt A/Ckt B	29.7/38.3	38.4/38.4	38.6/38.6	39.5/47.6	48.3/48.3	48.8/59.7	59.9/59.9
COMPRESSORS							
	Scroll, Hermetic						
Quantity	5	6	6	5	6	6	6
Speed (R/s)	58.3 (60 Hz)/48.3 (50 Hz)						
(Qty, kW) Ckt A	(2) 53	(3) 46	(3) 53	(1) 70 (1) 87.9	(3) 70	(3) 70	(3) 87.9
(Qty, kW) Ckt B	(3) 53	(3) 53	(3) 53	(3) 70	(3) 70	(3) 87.9	(3) 87.9
Oil Charge (L) Ckt A/Ckt B	6.5/9.7	9.7/9.7	9.7/9.7	13.4/20.1	20.1/20.1	20.1/20.1	20.1/20.1
No. Capacity Steps							
Standard	5	6	6	5	6	6	6
With Hot Gas Bypass	6	7	7	6	7	7	7
Digital Compressor Option	55	66	66	—	—	—	—
Minimum Capacity Step (%)							
Standard	20	15	17	19	17	15	17
With Hot Gas Bypass	13	9	11	13	11	9	11
Digital Compressor Option	7	5	6	—	—	—	—
Capacity (%)							
Circuit A	40	46	50	43	50	44	50
Circuit B	60	54	50	57	50	56	50
COOLER							
	Braze, Direct-Expansion Plate Heat Exchanger						
Weight (kg) (empty)	89.4	103.4	111.1	121.0	137.7	151.3	171.2
Net Fluid Volume (L)	16.3	18.9	25.7	28.0	32.5	35.9	41.2
Maximum Refrigerant Pressure (kPa)	3103	3103	3103	3103	3103	3103	3103
Maximum Water-Side Pressure Without Pump(s) (kPa)	2068	2068	2068	2068	2068	2068	2068
Maximum Water-Side Pressure With Pump(s) (kPa)	1034	1034	1034	1034	1034	1034	1034
CHILLER WATER CONNECTIONS (in.)							
Inlet and Outlet, Victaulic (IPS Carbon Steel)*	3	3	3	4	4	4	4
Drain (NPT)	1/4	1/4	1/4	1/4	1/4	1/4	1/4
CONDENSER FANS							
Standard Low-Sound AeroAcoustic™ Type							
Fan Speed (R/s)	14.2 (60 Hz)/11.8 (50 Hz)						
No. Blades...Diameter (mm)	9...762	9...762	9...762	9...762	9...762	9...762	9...762
No. Fans	5	6	6	7	8	9	10
Total Airflow, 60 Hz (L/s)	22 890	27 467	27 467	32 045	36 623	41 201	45 779
Total Airflow, 50 Hz (L/s)	19 120	22 943	22 943	26 767	30 591	34 415	38 239
Optional Value Sound Type							
Fan Speed (R/s)	19.0 (60 Hz)/15.8 (50 Hz)						
No. Blades...Diameter (mm)	4...762	4...762	4...762	4...762	4...762	4...762	4...762
No. Fans	5	6	6	7	8	9	10
Total Airflow, 60 Hz (L/s)	24 187	29 025	29 025	33 862	38 700	43 537	48 375
Total Airflow, 50 Hz (L/s)	20 204	24 245	24 245	28 285	32 326	36 367	40 407
CONDENSER COILS							
	Novation® MCHX Aluminum Tube, Aluminum Fin or RTPF						
Quantity (Ckt A/Ckt B)	2/3	3/3	3/3	3/4	4/4	4/5	5/5
Total Face Area (sq m)	11.6	13.9	13.9	16.2	18.5	20.8	23.2
Maximum Refrigerant Pressure (kPa)	4523	4523	4523	4523	4523	4523	4523
HYDRONIC MODULE (Optional, 60 Hz Only)†							
Pump	Pump(s), Strainer with Blowdown Valve, Expansion Tank, Pressure Taps, Drain and Vent Plugs, Flow Switch, and Balance Valve						
Expansion Tank Volume (L)	Single or Dual, Centrifugal Monocell Pump(s), 3500 Rpm. Dual pumps with check valves and isolation valves.						
Total/Acceptance	—	—	—	—	—	—	—
CHASSIS DIMENSIONS (mm)							
Length	3826	3826	3826	4864	4864	5893	5893
Width	2241	2241	2241	2241	2241	2241	2241
Height	1976	1976	1976	1976	1976	1976	1976

LEGEND

- EXV — Electronic Expansion Valve
- MCHX — Microchannel Heat Exchanger
- RTPF — Round Tube, Plate Fin (Condenser Coil)

*Unit connection is IPS Carbon Steel piping.
†Flow switch and strainer are standard on all units, with or without hydronic package.

NOTE: 30RAP chillers with Greenspeed intelligence are not available on unit sizes 070-150.

CAUTION - NOTICE TO RIGGERS:

ALL PANELS MUST BE IN PLACE WHEN RIGGING. FORK ONLY THROUGH BASE RAIL FORK OPENINGS.

NOTES:

1. RIG WITH FOUR CABLES USING A MINIMUM 20 FT. (6096mm) LENGTH FOR 010-030 SIZES AND 24 FT. (7315mm) LENGTH FOR 035-060 SIZES.
2. CENTRAL LIFTING POINT MUST BE A MINIMUM OF 10 FT. (3048mm) FOR 010-030 SIZES AND 12 FT. (3658mm) FOR 035-060 SIZES ABOVE THE TOP OF THE UNIT.
3. LIFTING HOLES PROVIDED ARE 2.25 IN. (57.2mm) DIAMETER.
4. CHECK BILL OF LADING FOR SHIPPING WEIGHT OF UNIT.
5. 010-030 SIZES SUBTRACT 230 LBS (104 KGS) FROM THE MAX WEIGHT FOR UNITS WITHOUT PUMPS. 035-060 SIZES SUBTRACT 290 LBS (132 KGS) FROM THE MAX WEIGHT FOR UNITS WITHOUT PUMPS.

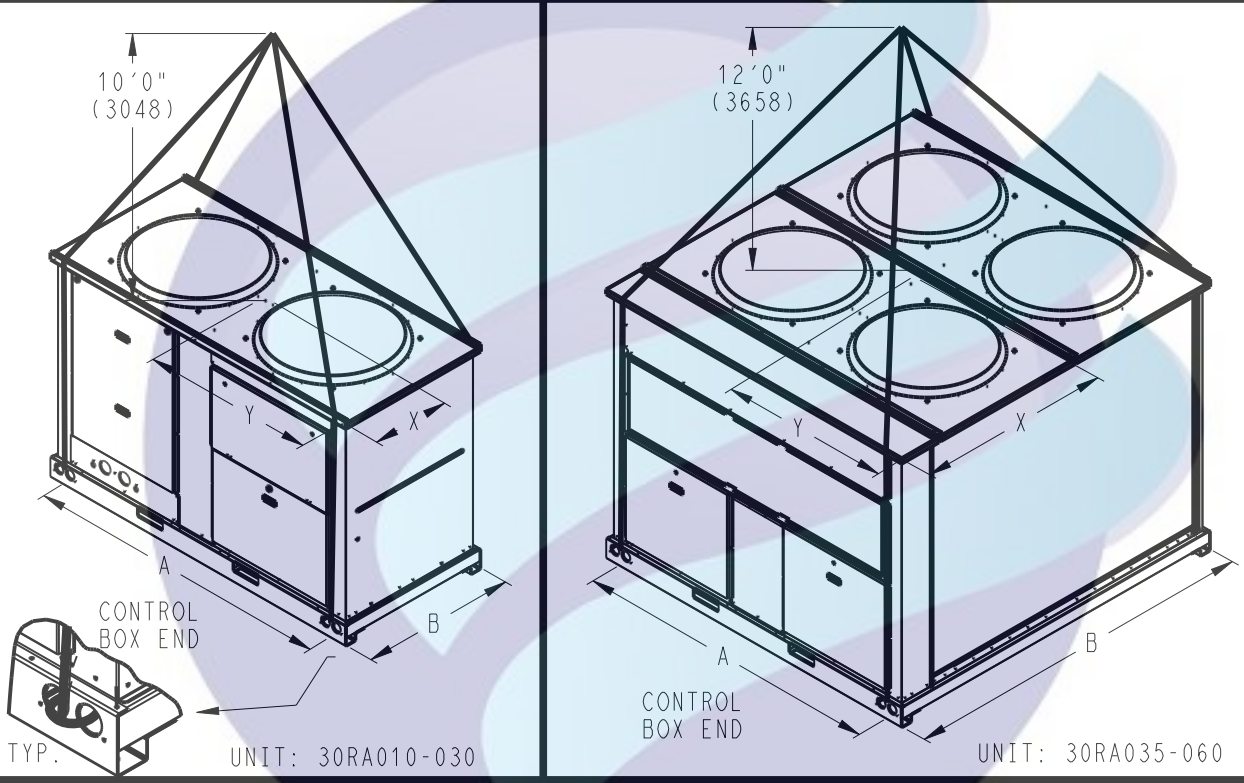

MODEL NUMBER	MCHX				RTPF(CU/CU)				LIFTING HOLES				CENTER OF GRAVITY			
	MAX. SHIP WT. W/O PACKAGING		MAX. SHIP WT. W/PACKAGING		MAX. SHIP WT. W/O PACKAGING		MAX. SHIP WT. W/PACKAGING		A		B		X		Y	
	LBS	KGS	LBS	KGS	LBS	KGS	LBS	KGS	IN	MM	IN	MM	IN	MM	IN	MM
30RA011	1087	493	1165	528	1228	557	1306	593	57.4	1458	40.3	1022	19.4	467	34.8	960
30RA016	1125	510	1203	546	1266	574	1344	609	57.4	1458	40.3	1022	19.1	466	34.3	957
30RA018	1450	658	1536	697	1662	754	1748	793	79.4	2017	40.3	1022	19.3	467	38.8	985
30RA020	1458	661	1544	700	1670	758	1756	797	79.4	2017	40.3	1022	19.3	467	38.8	985
30RA025	1567	711	1653	750	1833	831	1919	870	79.4	2017	40.3	1022	19.6	472	38.9	989
30RA030	1608	729	1694	768	1873	850	1959	889	79.4	2017	40.3	1022	19.6	472	39.0	990
30RA035	2850	1293	3055	1386	3275	1485	3480	1578	79.4	2017	92.1	2340	36.5	926	46.1	1171
30RA040	2872	1303	3077	1396	3297	1495	3502	1588	79.4	2017	92.1	2340	36.2	921	44.0	1118
30RA045	2925	1327	3130	1420	3456	1568	3661	1661	79.4	2017	92.1	2340	36.2	921	46.2	1172
30RA050	2950	1338	3155	1431	3481	1579	3686	1672	79.4	2017	92.1	2340	36.0	914	44.0	1118
30RA055	3056	1386	3261	1479	3587	1627	3792	1720	79.4	2017	92.1	2340	36.5	927	44.6	1133
30RA060	3062	1389	3267	1482	3593	1630	3798	1723	79.4	2017	92.1	2340	36.5	927	44.6	1132

38AP50000200 REV. -

Fig. 7 — Unit Rigging Label Detail (011-060 Sizes)

CAUTION - NOTICE TO RIGGERS:

ALL PANELS MUST BE IN PLACE WHEN RIGGING. DO NOT FORK THIS UNIT WITHOUT SKID.
NOTES:

1. RIG WITH FOUR CABLES USING A MINIMUM 24 FT. (7315MM) LENGTH FOR 070-115 SIZES. RIG WITH SIX CABLES FOR 130, 150 TON.
2. CENTRAL LIFTING POINTS MUST BE A MINIMUM OF 12 FT. (3658MM) ABOVE THE TOP OF THE UNIT.
3. LIFTING HOLES PROVIDED ARE 2.5 IN. (63.5MM) DIAMETER. 30RAP130 AND 30RAP150 HAVE A MIDDLE LIFTING HOLE, WHICH IS LOCATED 115.5 IN. (2921 MM) FROM THE CONTROL BOX SIDE LIFTING HOLE.
4. CHECK BILL OF LADING FOR SHIPPING WEIGHT OF UNIT.

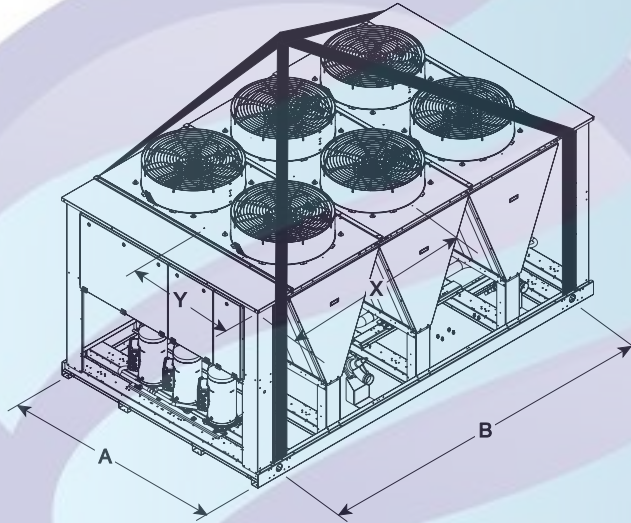

MODEL NUMBER	MAX. SHIP WT. W/O PACKAGING		MAX. SHIP WT. W/PACKAGING		MAX. SHIP WT. W/O PACKAGING		MAX. SHIP WT. W/PACKAGING		MAX. SHIP WT. W/O PACKAGING		MAX. SHIP WT. W/PACKAGING	
	LBS	KGS	LBS	KGS	LBS	KGS	LBS	KGS	LBS	KGS	LBS	KGS
	MCHX COILS				AL-CU COILS				CU-CU COILS			
30RAP070	3991	1810	4121	1869	4340	1968	4470	2027	4940	2240	5070	2299
30RAP080	4289	1945	4419	2004	4637	2103	4767	2194	5357	2429	5487	2520
30RAP090	4310	1955	4440	2014	4663	2114	4793	2205	5383	2441	5513	2532
30RAP100	5267	2389	5417	2457	6125	2778	6275	2846	6965	3159	7118	3228
30RAP115	5575	2528	5725	2596	6507	2951	6657	3019	7467	3386	7617	3454
30RAP130	7010	3179	7190	3261	7672	3479	7852	3561	8752	3969	8932	4051
30RAP150	7485	3394	7665	3476	8220	3728	8400	3809	9420	4272	9600	4354

	LIFTING HOLES				CENTER OF GRAVITY			
	A		B		X		Y	
	IN	MM	IN	MM	IN	MM	IN	MM
30RAP070	88.0	2235	131.6	3343	68.8	1748	44.4	1128
30RAP080	88.0	2235	131.6	3343	70.7	1796	44.9	1140
30RAP090	88.0	2235	131.6	3343	70.8	1798	46.5	1181
30RAP100	88.0	2235	171.8	4364	87.1	2212	45.3	1151
30RAP115	88.0	2235	171.8	4364	90.5	2299	45.2	1148
30RAP130	88.0	2235	212.1	5387	104.3	2649	45.4	1153
30RAP150	88.0	2235	212.1	5387	108.1	2746	45.3	1151

DEDUCT THESE VALUES FOR UNITS WITH NO PUMP OPTIONS		
	SINGLE PUMP DEDUCT LBS/KGS	NO PUMP DEDUCT LBS/KGS
30RAP 070,080,090	280/127	635/288
30RAP 100,115,130,150	285/129	675/306

38AP503120

Fig. 8 — Unit Rigging Label Detail (070-150 Sizes)

MOUNTING UNIT — When unit is in proper location, use of mounting holes in base rails is recommended for securing unit to supporting structure, or for mounting unit on vibration isolators if required. See Fig. 9-16. Fasteners for mounting unit are field supplied. Be sure unit is level to within $\frac{1}{8}$ in. (.32 mm) per foot for proper oil return to compressor.

Step 2 — Check Compressor Mounting — As shipped, units with single compressors are held down with 4 bolts through rubber grommets. All units with tandem compressors are held down with 6 bolts per pair through grommets. After unit is installed, verify mounting bolt torque 7 to 10 ft-lb (9.5 to 13.6 N•m).

For 30RAP100-150 units, RED bolts from compressor mounting rail must be removed. These RED bolts are for shipping purposes only. Also remove the RED shipping braces that tie the compressors in a circuit together. Using a 15-mm socket, loosen each bolt and nut on each compressor tab and remove all braces before unit start-up.

Step 3 — Connect Cooler Fluid and Drain Piping

ALL UNITS — These chillers are supplied with factory-installed strainer (including blow-down valve) in the entering fluid piping and flow switch in the leaving fluid piping. Flow switch wiring is factory installed.

⚠ CAUTION

Do not circulate water through unit without strainer in place. Failure to use the strainer represents abuse and may impair or otherwise negatively affect the Carrier product warranty.

Piping connections are located on the front of the chiller when facing the control panel for sizes 011-030 and at the end opposite the control panel for sizes 035-060. For sizes 070-150, piping connections are on the right side when facing the control panel and (Circuit B) of the chiller. See Fig. 9-16, depending on model. See Fig. 17-19 for accessory storage tank dimensions.

All sizes have carbon steel Victaulic IPS connections as shown in the physical data tables. Any connecting pipe to the 30RAP unit must be of a material that will not cause any galvanic corrosion. For this reason, dissimilar metals must not be used unless joined by a dielectric coupling.

Provide a means of venting air from the high point of the field-installed piping as required. Install field-supplied drains in both the entering and leaving fluid connections.

After field piping is complete, freeze-up protection is recommended using inhibited glycol or other suitable inhibited antifreeze solution and electric heat tapes in areas where piping is exposed to low ambient temperatures (34°F [1°C] or below). Heat tapes should possess a rating for area ambient temperatures and be covered with a suitable thickness of closed-cell insulation. Route power for heating tapes from a separately fused disconnect. Identify disconnect as heat tape power source with a warning that power must not be turned off except when unit is being serviced.

Installation of water systems should follow sound engineering practice as well as applicable local and industry standards. Improperly designed or installed systems may cause unsatisfactory operation and/or system failure. Consult a water treatment specialist or appropriate literature for information regarding filtration, water treatment, and control devices.

IEECSA
AIRE ACONDICIONADO

UNIT	CENTER OF GRAVITY		UNIT HEIGHT		WATER CONNECTION VICINIAUS FPS CARRON STEEL
	X	Y	H (STANDARD)	H (VALUE SOUND)	
30RA011	19.40 [493]	34.80 [884]	66.5 [1689]	61.0 [1549]	2"
30RA016	19.10 [485]	34.30 [871]	66.5 [1689]	61.0 [1549]	2"

NOTES:

- DO NOT CAP OR OTHERWISE OBSTRUCT THE LIQUID LINE TEMPERATURE RELIEF.
- Ø7/8 [22.4] PILOT HOLE PROVIDED FOR LOCATING FIELD POWER WIRING. ACTUAL HOLE REQUIRED DEPENDS ON FIELD WIRE SIZING.
- Ø0.437 [11.10] HOLE USED FOR MOUNTING UNIT.
- UNIT MUST HAVE CLEARANCES AS FOLLOWS:
TOP - DO NOT RESTRICT.
COIL SIDE - 42 [1067] FROM SOLID SURFACE.
PANEL SIDE - 46 [1219] PER NEC.
- SEE TABLE COLUMN H: DIMENSION FOR STANDARD FAN OR VALUE SOUND FAN OPTION.
- CARRIER DOES NOT RECOMMEND INSTALLATION IN A PIT.
- UNIT CAN BE HANDLED USING THE FORK TRUCK LIFT POCKETS.
- WATER CONNECTIONS RECESSED 2-3/8 INCHES INSIDE UNIT. ALL WATER DRAIN AND VENTING HOLES ARE 1/4" NPT.

DIMENSIONS IN () ARE IN MILLIMETERS

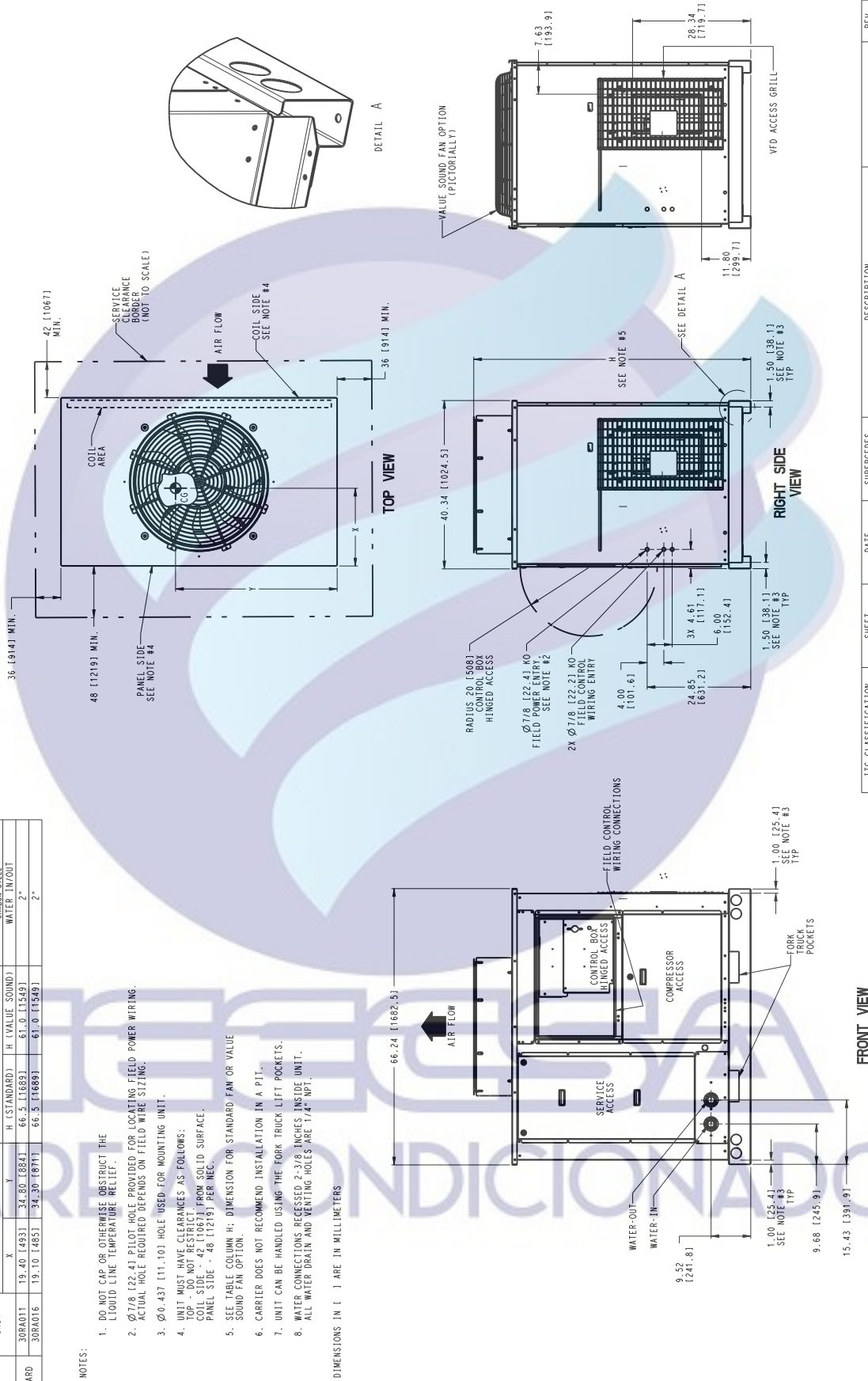

TIC CLASSIFICATION	SHEET	DATE	SUPERCEDES	DESCRIPTION	REV
U.S. - ECCN:EAR99	1 OF 1	09/07/18	A	38RAP011-016 UNIT ASSY	B

Fig. 9 — Dimensions — 30RAP011 and 016 Units

UNIT	CENTER OF GRAVITY		UNIT HEIGHT	POWER ENTRY	WATER CONNECTION	
	X	Y			MCHANICAL	STEEL
30RA018	19.30 (490)	38.77 (985)	H (VALUE SOUND)	P	WATER IN/OUT	2"
30RA020	19.30 (490)	38.79 (985)	66.5 (1689)	24.9 (631)	WATER IN/OUT	2"
30RA025	19.60 (498)	38.93 (989)	61.0 (1549)	24.9 (631)	WATER IN/OUT	2"
30RA030	19.60 (498)	38.98 (990)	73.0 (1854)	36.9 (936)	WATER IN/OUT	2"

NOTES:

- DO NOT CAP OR OTHERWISE OBSTRUCT THE LIQUID LINE TEMPERATURE RELIEF.
- Ø7/8 (22.4) PILOT HOLE PROVIDED FOR LOCATING FIELD POWER WIRING. ACTUAL HOLE REQUIRED DEPENDS ON FIELD WIRE SIZING.
- Ø0.437 (11.101) HOLE USED FOR MOUNTING UNIT.
- UNIT MUST HAVE CLEARANCES AS FOLLOWS:
 COIL SIDE - 42 (1067) FROM SOLID SURFACE.
 PANEL SIDE - 48 (1219) PER NEC.
 SEE TABLE COLUMN H; DIMENSION FOR STANDARD FAN OR VALUE SOUND FAN OPTION.
- CARRIER DOES NOT RECOMMEND INSTALLATION IN A PIT.
- UNIT CAN BE HANDLED USING THE FORK TRUCK LIFT POCKETS.
- WATER CONNECTIONS RECESSED 2 INCHES INSIDE UNIT.
 ALL WATER DRAIN AND VENTING HOLES ARE 1/4" NPT.

DIMENSIONS IN () ARE IN MILLIMETERS

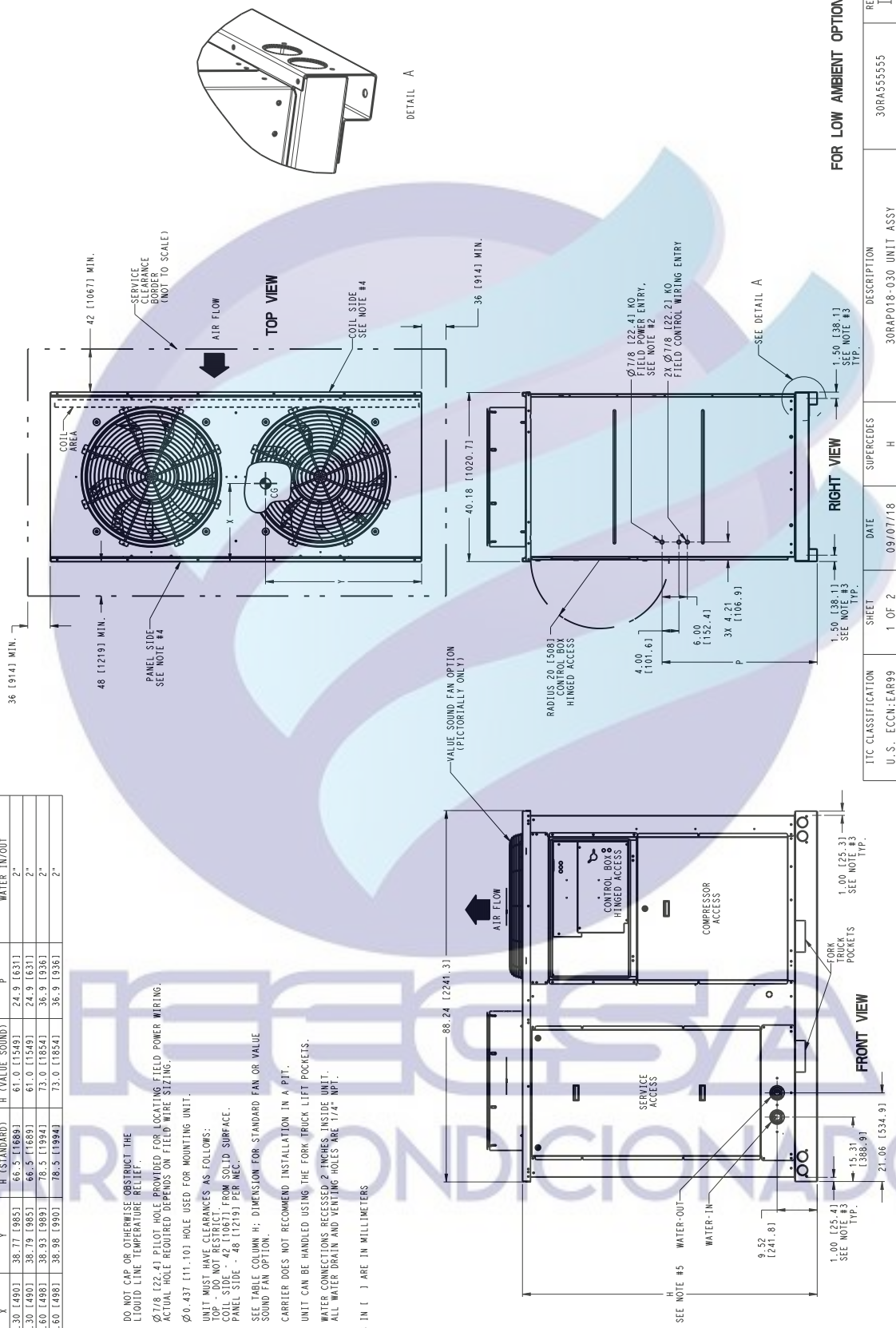

FOR LOW AMBIENT OPTION

ITC CLASSIFICATION	SHEET	DATE	SUPERCEDES	DESCRIPTION	REV
U.S. ECCN:EAR99	1 OF 2	09/07/18	H	30RAP018-030 UNIT ASSY	I

Fig. 10 — Dimensions — 30RAP018-030 Units with Fixed Speed Fans

UNIT	CENTER OF GRAVITY		UNIT HEIGHT	POWER ENTRY	WATER CONNECTION	
	X	Y			H (STANDARD)	MICHAUD I/P
30RA018	19.30 (490)	38.77 (985)	66.5 (1683)	P	24.9 (631)	2*
30RA020	19.30 (490)	38.79 (985)	66.5 (1683)	P	24.9 (631)	2*
30RA025	19.60 (498)	38.93 (989)	78.5 (1994)	P	36.9 (936)	2*
30RA030	19.60 (498)	38.98 (990)	78.5 (1994)	P	36.9 (936)	2*

NOTES:

- DO NOT CAP OR OTHERWISE OBSTRUCT THE LIQUID LINE TEMPERATURE RELIEF.
- Ø7/8 (22.4) PILOT HOLE PROVIDED FOR LOCATING FIELD POWER WIRING. ACTUAL HOLE REQUIRED DEPENDS ON FIELD WIRE SIZING.
- Ø0.437 (11.101) HOLE USED FOR MOUNTING UNIT.
- UNIT MUST HAVE CLEARANCES AS FOLLOWS:
 COIL SIDE - 42 (1067) FROM SOLID SURFACE.
 PANEL SIDE - 48 (1219) PER NEC.
- SEE TABLE COLUMN H; DIMENSION FOR STANDARD FAN OR VALUE SOUND FAN OPTION.
- CARRIER DOES NOT RECOMMEND INSTALLATION IN A PIT.
- UNIT CAN BE HANDLED USING THE FORK TRUCK LIFT POCKETS.
- WATER CONNECTIONS RECESSED 2 INCHES INSIDE UNIT.
 ALL WATER DRAIN AND VENTING HOLES ARE 1/4" NPT.

DIMENSIONS IN () ARE IN MILLIMETERS

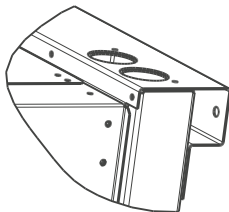
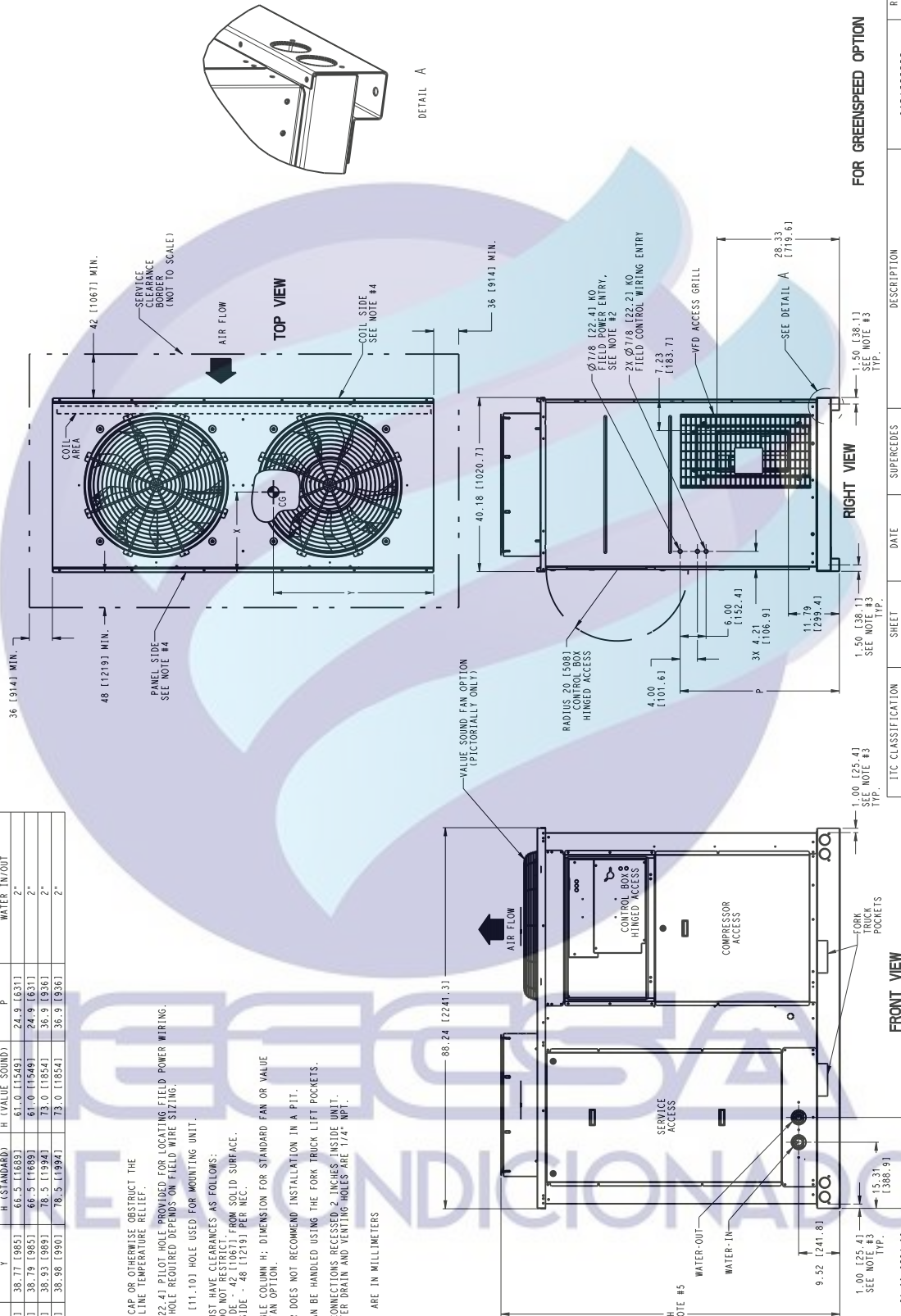

FOR GREENSPEED OPTION

I/C CLASSIFICATION	SHEET	DATE	SUPERCEDES	DESCRIPTION	REV
U.S. ECCN:EAR99	2 OF 2	09/07/18	H	30RAP018-030 UNIT ASSY	I
				30RA555555	

Fig. 11 — Dimensions — 30RAP018-030 Units with Greenspeed® Intelligence

UNIT	CENTER OF GRAVITY		UNIT HEIGHT	WATER CONNECTION TO CARBON STEEL	
	X	Y		H (VALUE SOUND)	WATER IN/OUT
30RA035	36.45 [1926]	146.08 [11170]	66.5 [1689]	61.0 [1549]	2-1/2"
30RA040	36.24 [1921]	144.03 [11168]	66.5 [1689]	61.0 [1549]	2-1/2"
30RA045	36.24 [1921]	146.15 [11172]	78.5 [1994]	73.0 [1854]	2-1/2"
30RA050	36.00 [1914]	144.00 [11172]	78.5 [1994]	73.0 [1854]	2-1/2"
30RA055	36.48 [1927]	144.00 [11172]	78.5 [1994]	73.0 [1854]	2-1/2"
30RA060	36.50 [1927]	144.56 [11132]	78.5 [1994]	73.0 [1854]	2-1/2"

NOTES:

- DO NOT CAP OR OTHERWISE OBSTRUCT THE LIQUID LINE TEMPERATURE RELIEF.
- Ø7/8 [22.41] PILOT HOLE PROVIDED FOR LOCATING FIELD POWER WIRING. ACTUAL HOLE REQUIRED DEPENDS ON FIELD WIRE SIZING.
- Ø9.437 [11.101] HOLE USED FOR MOUNTING UNIT.
- UNIT MUST HAVE CLEARANCES AS FOLLOWS:
TOP - DO NOT RESTRICT FROM SOLID SURFACE.
COIL SIDE - 42 [1067] MIN.
PANEL SIDE - 48 [1219] MIN. PER REC.
- SEE TABLE COLUMN H: DIMENSION FOR STANDARD FAN OR VALUE SOUND FAN OPTION.
- CARRIER DOES NOT RECOMMEND INSTALLATION IN A PIT.
- UNIT CAN BE HANDLED USING THE FORK TRUCK LIFT POCKETS (MINIMUM OF 80" FORK LENGTH).
- WATER CONNECTIONS RECESSED 2-5/8" INCHES INSIDE UNIT. ALL WATER DRAIN AND VENTING HOLES ARE 1/4" NPT.

DIMENSIONS IN [] ARE IN MILLIMETERS

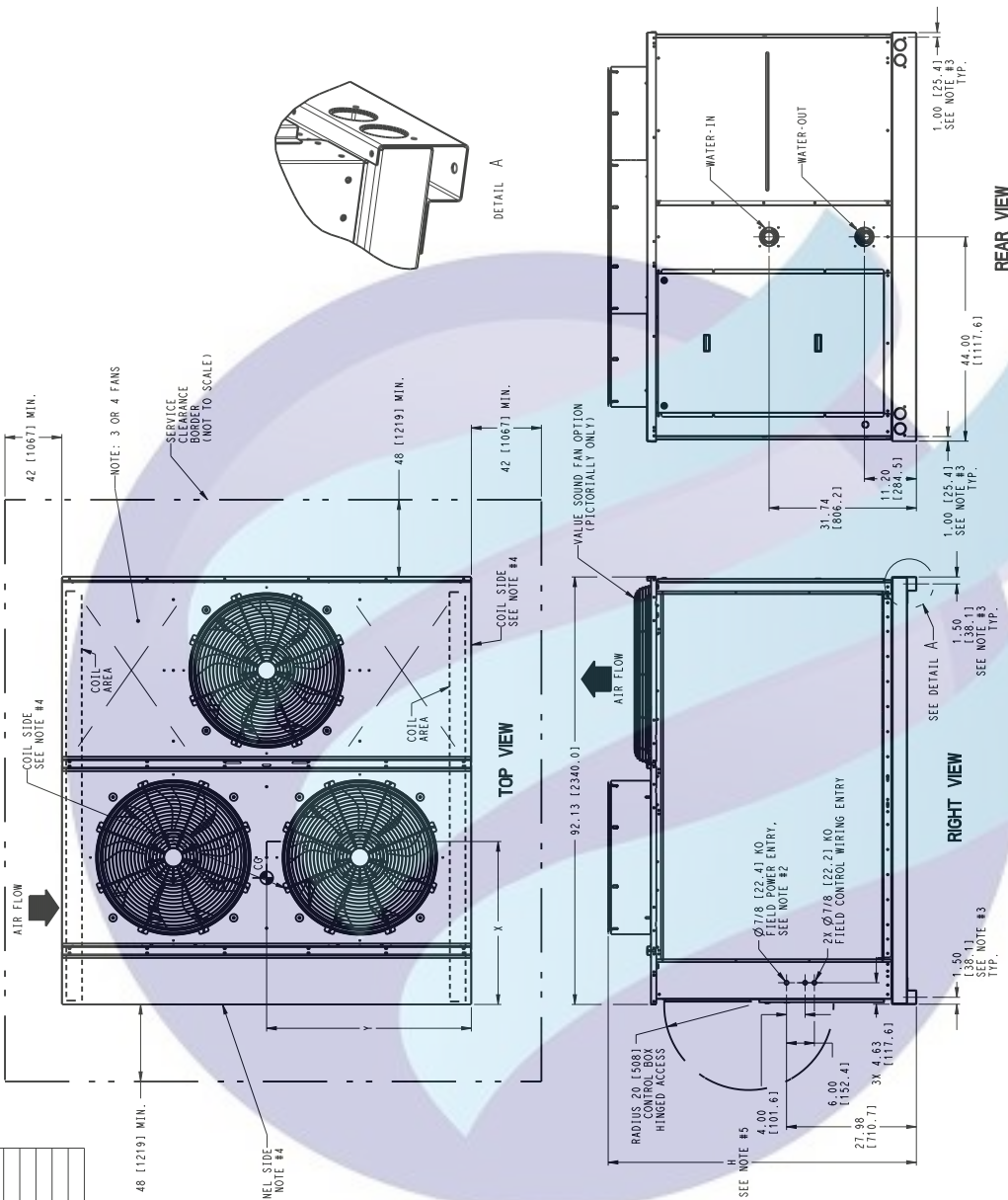

FOR LOW AMBIENT OPTION

DATE	09/10/7/15	REV	H
SUPERSEDES	G	30RAP035-060 UNIT ASSY	30RA555556

Fig. 12 — Dimensions — 30RAP035-060 Units with Fixed Speed Fans

UNIT	CENTER OF GRAVITY		UNIT HEIGHT		WATER CONNECTIONS (CARBON STEEL)	
	X	Y	H (STANDARD)	H (VALUE SOUND)	WATER IN/OUT	WATER IN/OUT
30RA035	36.45 [926]	46.08 [1170]	66.5 [1689]	61.0 [1549]	2-1/2"	2-1/2"
30RA040	36.24 [921]	44.03 [1119]	66.5 [1689]	61.0 [1549]	2-1/2"	2-1/2"
30RA045	36.24 [921]	44.03 [1119]	78.5 [1994]	73.0 [1854]	2-1/2"	2-1/2"
30RA050	36.00 [914]	44.00 [1119]	78.5 [1994]	73.0 [1854]	2-1/2"	2-1/2"
30RA055	36.48 [927]	44.60 [1133]	78.5 [1994]	73.0 [1854]	2-1/2"	2-1/2"
30RA060	36.50 [927]	44.56 [1132]	78.5 [1994]	73.0 [1854]	2-1/2"	2-1/2"

- NOTES:
- DO NOT CAP OR OTHERWISE OBSTRUCT THE LIQUID LINE TEMPERATURE RELIEF.
 - Ø7/8 (22.4) PILOT HOLE PROVIDED FOR LOCATING FIELD POWER WIRING. ACTUAL HOLE REQUIRED DEPENDS ON FIELD WIRE SIZING.
 - Ø0.437 (11.1) HOLE USED FOR MOUNTING UNIT.
 - UNIT MUST HAVE CLEARANCES AS FOLLOWS:
COIL SIDE - 42 (1067) FROM SOLID SURFACE.
PANEL SIDE - 48 (1219) PER NEC.
 - SEE TABLE COLUMN H: DIMENSION FOR STANDARD FAN OR VALUE SOUND FAN OPTION.
 - CARRIER DOES NOT RECOMMEND INSTALLATION IN A PIT.
 - UNIT CAN BE HANDLED USING THE FORK TRUCK LIFT POCKETS (MINIMUM OF 60" FORK LENGTH).
 - WATER CONNECTIONS RECESSED 2-5/8 INCHES INSIDE UNIT. ALL WATER DRAIN AND VENTING HOLES ARE 1/4" NPT.

DIMENSIONS IN () ARE IN MILLIMETERS

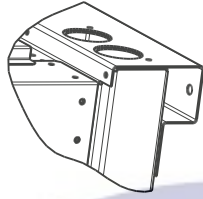
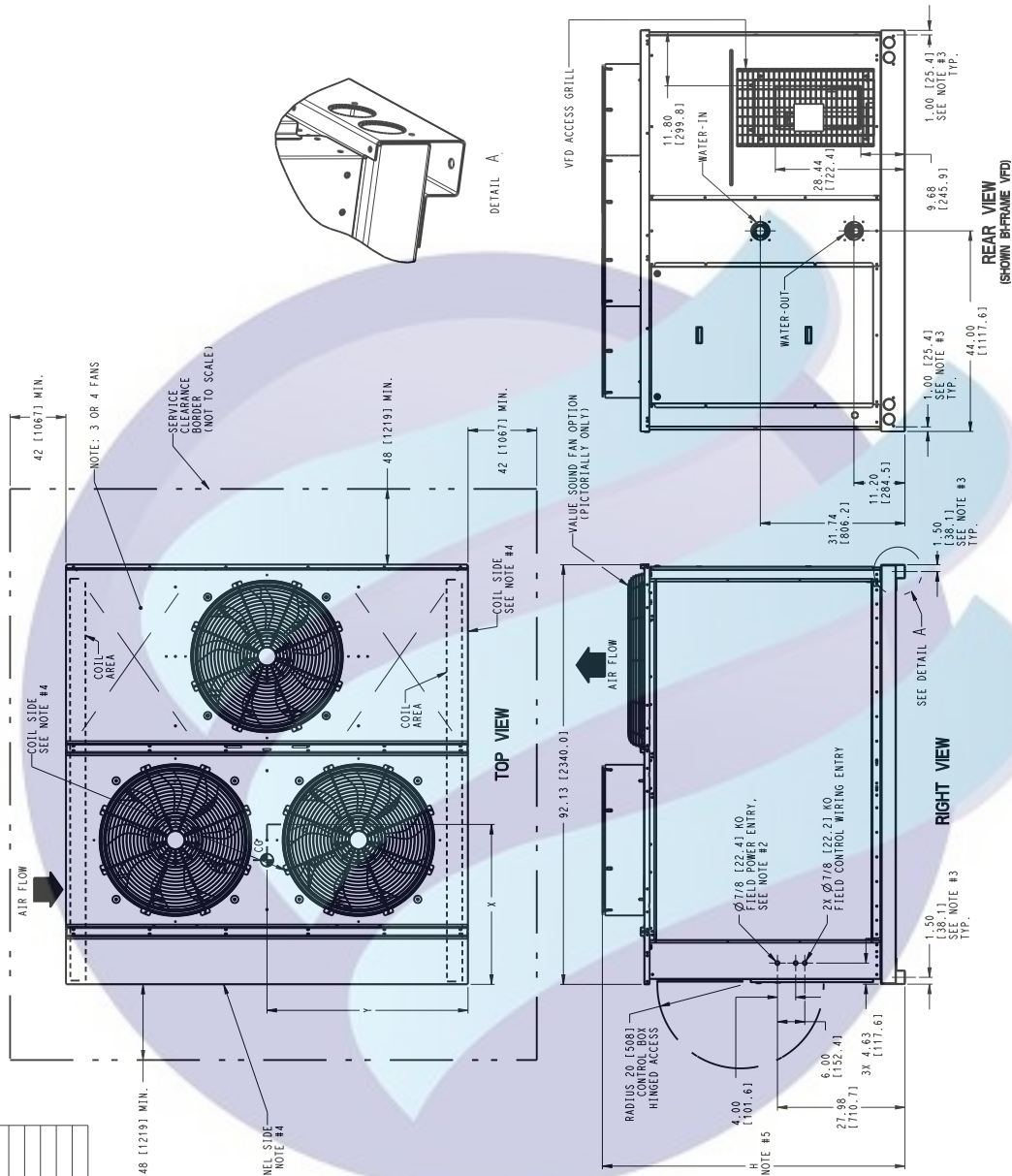

DETAIL A

DATE	09/07/15	SUPPLIERS	30RAP035-060 UNIT ASSY	REV	H

FOR GREENSPEED OPTION

Fig. 13 — Dimensions — 30RAP035-060 Units with Greenspeed® Intelligence

NOTES: 1. UNIT MUST HAVE CLEARANCES AS FOLLOWS:

- TOP: DO NOT RESTRICT TOP SURFACE FOR AIRFLOW
- LEFT: 8" REQUIRED FOR COIL SERVICE AREA
- RIGHT: 8" REQUIRED FOR COIL SERVICE AREA
- ALL PUMPS HAVE DRAINS LOCATED AT THE BOTTOM OF VOLUME FOR DRAINING.
- TEMPERATURE RELIEF DEVICES LOCATED ON SUCTION LINE, LIQUID LINE AND DISCHARGE LINE OF PUMP CIRCUITS PROVIDER FOR LOCATING FIELD POWER WIRING.
- ACTUAL HOLE REQUIRED DEPENDS ON FIELD WIRE SIZING.
- DIMENSIONS ARE IN INCHES. DIMENSIONS IN [] ARE IN MILLIMETERS.
- FIELD CONTROL WIRING ENTRY POINTS USED FOR MOUNTING UNITS.
- FIELD CONTROL WIRING INFORMATION IS CONSISTENT WITH IFS CARBON STEEL PIPING.

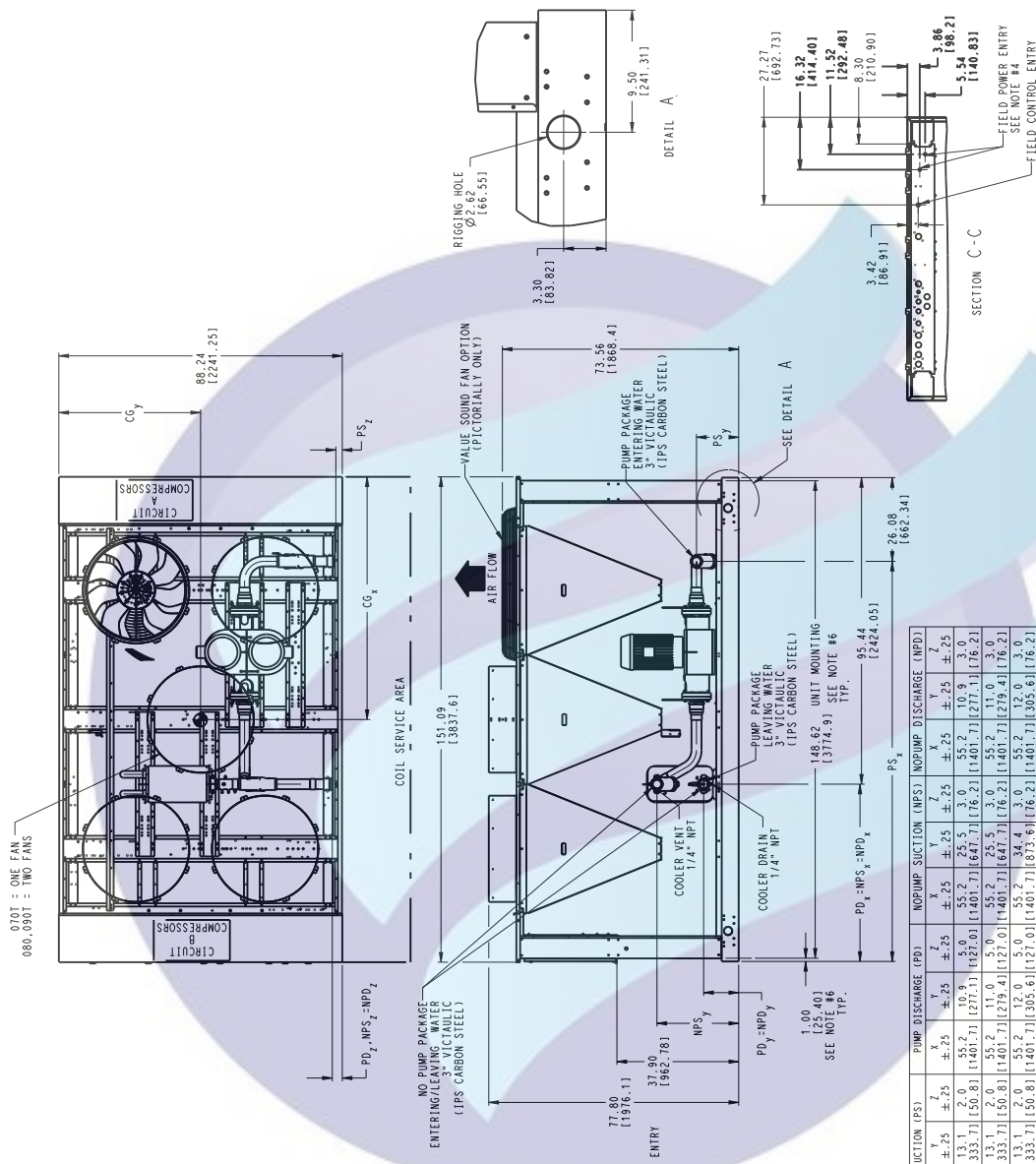

WEIGHT MCHX 1b/1g	MAX WEIGHT MCHX PUMP 1b/1g	WEIGHT AL-CU 1b/1g	MAX WEIGHT PUMP 1b/1g	CENTER OF GRAVITY			PUMP SUCTION (FPS)			PUMP DISCHARGE (FPI)			NOPUMP SUCTION (NPS)			NOPUMP DISCHARGE (NPD)													
				CGx INCH (MM)	CGy INCH (MM)	CGz INCH (MM)	X ±.25	Y ±.25	Z ±.25	X ±.25	Y ±.25	Z ±.25	X ±.25	Y ±.25	Z ±.25	X ±.25	Y ±.25	Z ±.25											
30RAP-070	3356.7	3997.1	3705.7	4340.7	4305.7	4940.7	85	41.5	124.5	13.1	2.0	55.2	25.5	3.0	55.2	25.5	3.0	55.2	25.5	3.0	55.2	25.5	3.0	55.2	25.5	3.0	55.2	25.5	3.0
30RAP-080	3522.0	4180.0	3968.0	4660.0	4620.0	5220.0	100	41.5	124.5	13.1	2.0	55.2	25.5	3.0	55.2	25.5	3.0	55.2	25.5	3.0	55.2	25.5	3.0	55.2	25.5	3.0	55.2	25.5	3.0
30RAP-090	3655.7	4310.7	4088.7	4988.7	4948.7	5588.7	110	41.5	124.5	13.1	2.0	55.2	25.5	3.0	55.2	25.5	3.0	55.2	25.5	3.0	55.2	25.5	3.0	55.2	25.5	3.0	55.2	25.5	3.0

DATE: 02/09/15
 SUPPLIERS: I
 30RAP-70, 80 AND 90 AIR COOLED CHILLERS
 30RA555557
 REV: J

Fig. 14 — Dimensions — 30RAP070-090 Units

NOTES: 1. UNIT MUST HAVE CLEARANCES AS FOLLOWS:

- TOP- DO NOT RESTRICT CLEARANCE FROM SOLID SURFACE, FOR AIRFLOW SIDES AND END OF UNIT.
- 2. ALL PUMPS HAVE DRAINS LOCATED AT THE BOTTOM OF VOLUME FOR DRAINING. TEMPERATURE RELIEF DEVICES LOCATED ON SUCTION LINE, LIQUID LINE AND FILTER ORIFICE OF EACH CIRCUIT AND HAVE 1/4" FLARE CONNECTION.
- 3. ACTUAL HOLE REQUIRED DEPENDS ON FIELD WIRE SIZING.
- 4. ACTUAL HOLE REQUIRED DEPENDS ON FIELD WIRE SIZING.
- 5. DIMENSIONS ARE IN INCHES. DIMENSIONS IN () ARE IN MILLIMETERS.
- 6. Ø1.524 (1.3.3) HOLE USED FOR MOUNTING UNITS.
- 7. IPS CARBON STEEL PIPING.

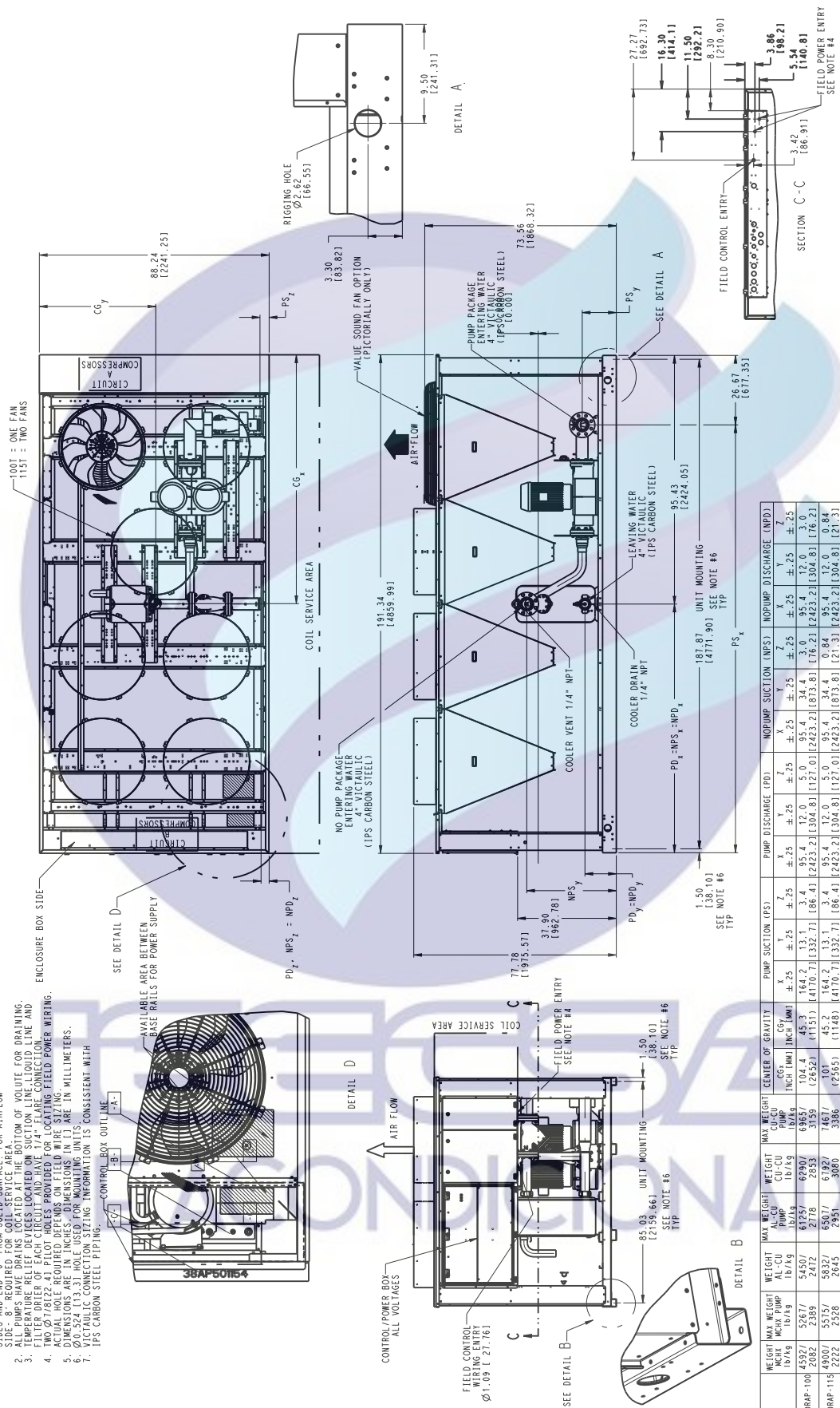

WEIGHT MCH	MAX WEIGHT AL-CU PUMP	WEIGHT CU-CU PUMP	MAX WEIGHT PUMP	CENTER OF GRAVITY INCH (MM)	PUMP SUCTION (PSI)			PUMP DISCHARGE (PSI)			NO PUMP SUCTION (MPS)			NO PUMP DISCHARGE (MPD)			
					X	Y	Z	X	Y	Z	X	Y	Z	X	Y	Z	
4092	5287	6179	6759	6200	104.4	49.0	104.4	104.4	49.0	104.4	104.4	49.0	104.4	49.0	104.4	49.0	104.4
4907	5575	6532	7137	7437	104.4	49.0	104.4	104.4	49.0	104.4	104.4	49.0	104.4	49.0	104.4	49.0	104.4
2222	2528	2645	2951	3080	104.4	49.0	104.4	104.4	49.0	104.4	104.4	49.0	104.4	49.0	104.4	49.0	104.4

DATE: 02/06/15
 SUPERSEDES: F
 30RAP-100 AND 115 AIR COOLED CHILLER
 30RA555538
 REV: G

Fig. 15 — Dimensions — 30RAP100,115 Units

NOTES: 1. UNIT MUST HAVE CLEARANCES AS FOLLOWS:
 TOP - DO NOT RESTRICT
 SIDES AND END - 6" FROM SOLID SURFACE FOR AIR FLOW
 SIDE AND END - 6" FOR COIL SERVICE AREA
 SIDE AND END - 6" FOR COIL SERVICE AREA BOTTOM OF VOLUTE FOR BRAINLING
 2. PUMPS, RELIEF VALVES OR COIL SERVICE AREA BOTTOM OF VOLUTE FOR BRAINLING
 3. TEMPERATURE RELIEF DEVICES LOCATED ON SUCTION LINE LIQUID LINE AND
 4. FILTER DRIER OF EACH CIRCUIT AND HAVE 1/4" FLARE CONNECTION.
 5. TWO Ø 7/8 (22.4) PILOT HOLES PROVIDED FOR LOCATING FIELD POWER WIRING.
 6. DIMENSIONS ARE IN INCHES DIMENSIONS IN [] ARE IN MILLIMETERS.
 7. VICTAULIC CONNECTION SIZING INFORMATION IS CONSISTENT WITH
 8. I/P CONTROL BOX WIRING

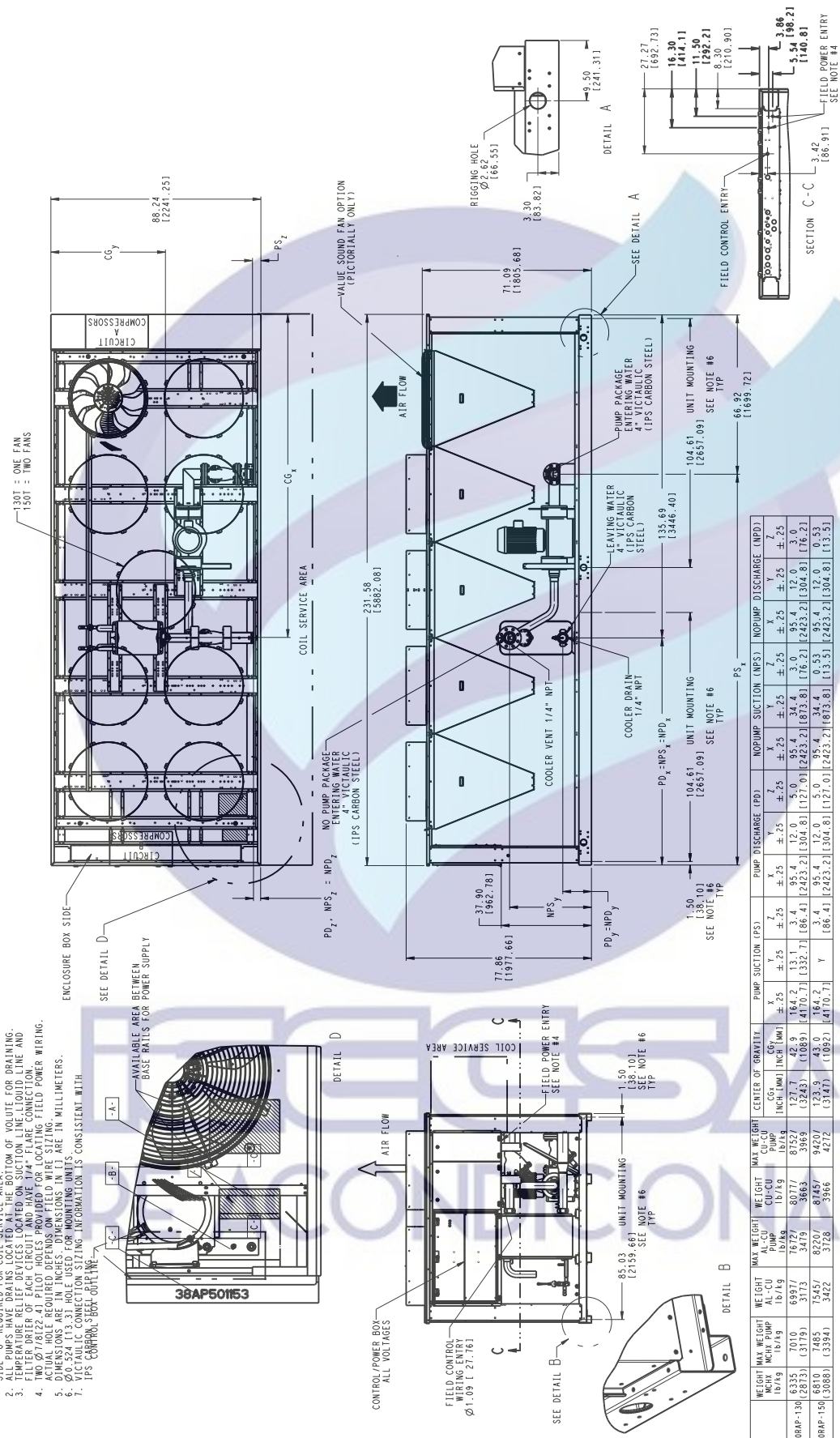

WEIGHT MCHT	MAX WEIGHT MCHT PUMP	WEIGHT AL-CU lb/kg	WEIGHT CU-CU lb/kg	MAX WEIGHT PUMP	CENTER OF GRAVITY			PUMP SUCTION (PS)			PUMP DISCHARGE (PD)			NO PUMP SUCTION (NPS)			NO PUMP DISCHARGE (NPD)		
					INCH	MM	INCH	MM	X	Y	Z	X	Y	Z	X	Y	Z	X	Y
30RAP-130	6335	7010	6997	7627	8077	127.7	42.9	164.2	13.1	3.4	95.4	12.0	5.0	95.4	34.4	3.0	95.4	12.0	3.0
	[2873]	[3179]	[3179]	[3479]	[3663]	[3243]	[1089]	[470.7]	[332.7]	[66.4]	[2423.2]	[304.8]	[127.0]	[2423.2]	[873.8]	[76.2]	[2423.2]	[304.8]	[176.2]
30RAP-150	6810	7485	7545	8207	8745	123.9	43.0	164.2	13.1	3.4	95.4	12.0	5.0	95.4	34.4	3.0	95.4	12.0	0.53
	[3088]	[3394]	[3422]	[3728]	[3986]	[3147]	[1092]	[470.7]	[332.7]	[66.4]	[2423.2]	[304.8]	[127.0]	[2423.2]	[873.8]	[76.2]	[2423.2]	[304.8]	[113.3]

Y : 13.1 (332.7) FOR DUAL PUMP AND 15.6 (396.2) FOR SINGLE PUMP

DATE	02/06/15	DATE	02/06/15
SUPERSEDES	F	SUPERSEDES	F
REV	G	REV	G

Fig. 16 — Dimensions — 30RAP130,150 Units

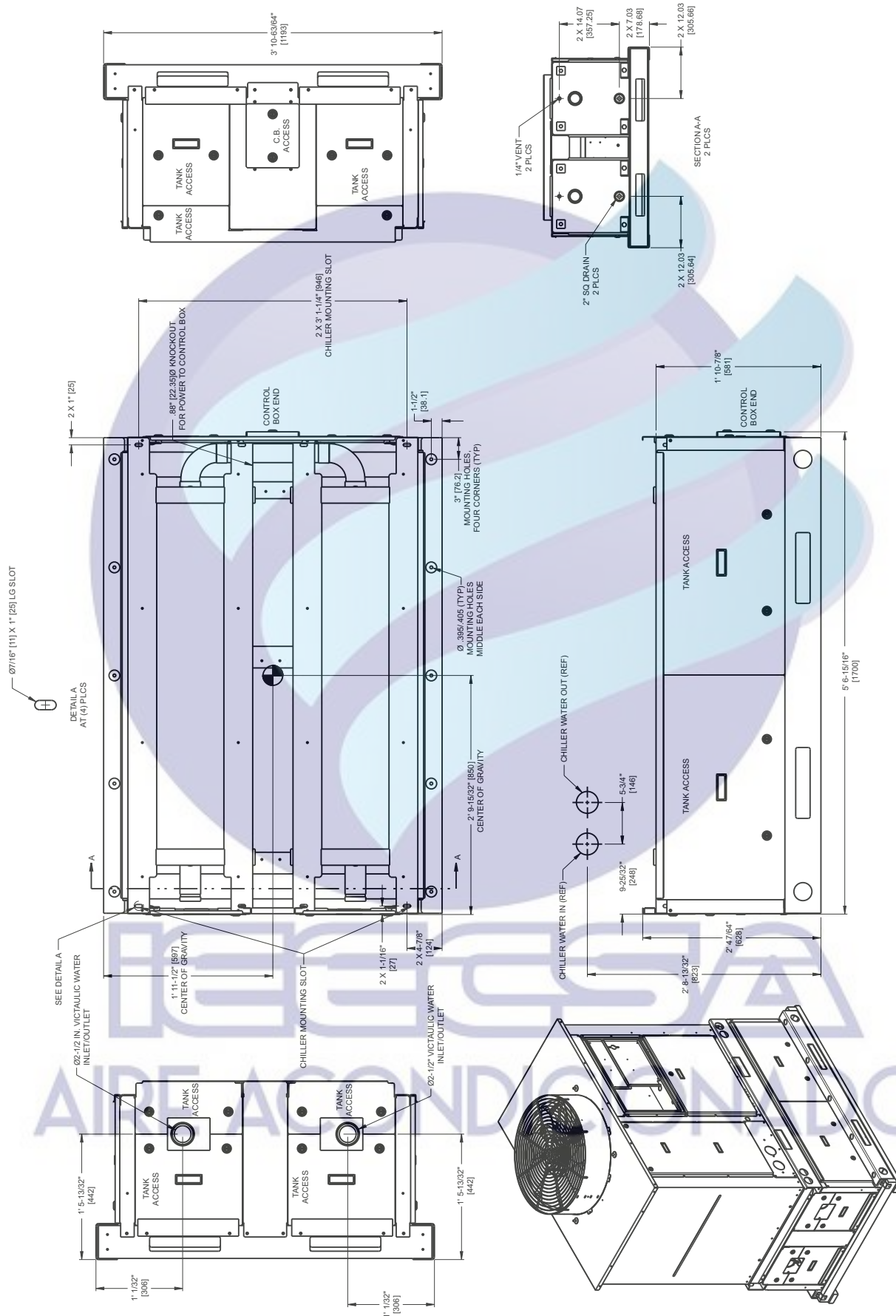

Fig. 17 — Accessory Storage Tank 30RA-900-050 Dimensions — 30RAP011,016 Units

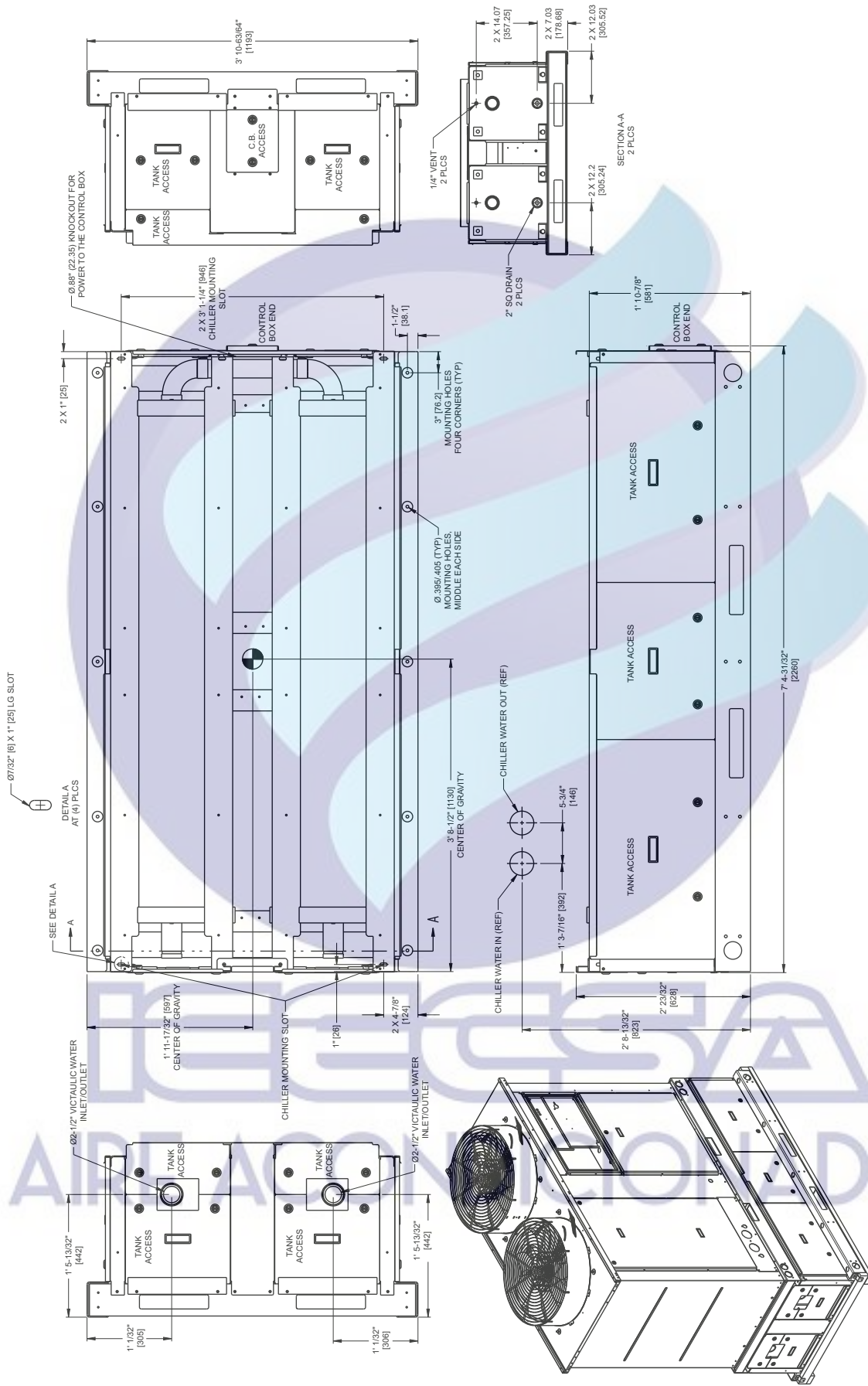

Fig. 18 — Accessory Storage Tank 30RA-900-051 Dimensions — 30RAP018-030 Units

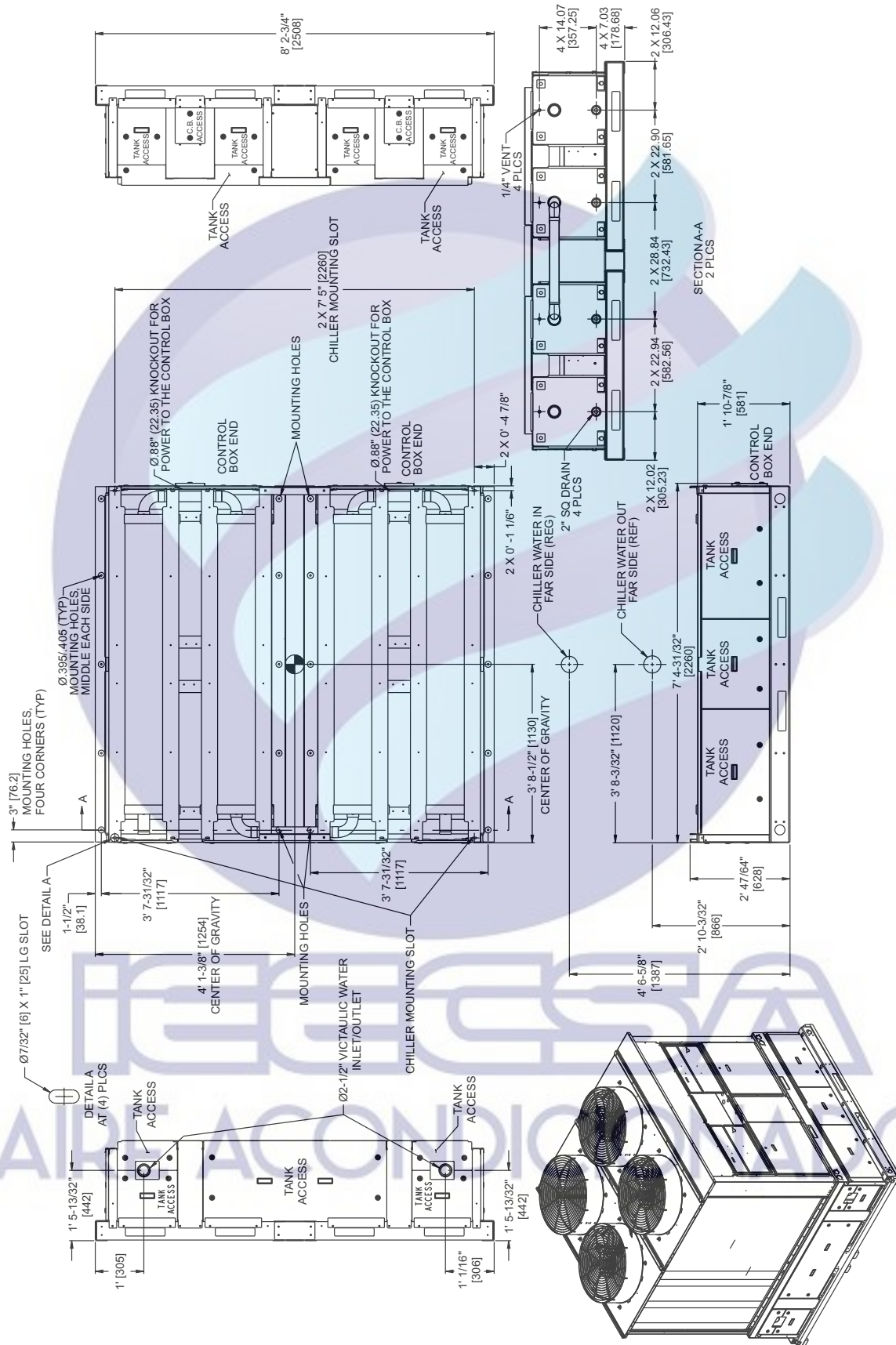

Fig. 19 — Accessory Storage Tank 30RA-900-052 Dimensions — 30RAP035-060 Units

Dual Chiller Control Option — If the dual chiller algorithm is utilized the machines must be installed in parallel. An additional chilled water sensor must be installed. Install the well in the common leaving water header. See Fig. 20 and 21.

Parallel chiller control with dedicated pumps is recommended. Chiller must start and stop its own water pump located in its own piping. If pumps are not dedicated for each chiller, then isolation valves are required. Each chiller must open and close its own isolation valve through the unit control (the valve must be connected to the pump outputs). See Fig. 21.

Do not relocate the chiller’s leaving water thermistors. They must remain in place for the unit to operate properly. The thermistor well is a 1/4-in. NPT fitting for mounting the well in the piping. Select a location that will allow for removal of the thermistor without any restrictions. Once the well is installed, insert the thermistor into the well utilizing thermal conductive grease. Once the thermistor is in place, it is recommended that a thermistor wire loop be made and secured with a wire tie to the well. Attach the dual leaving water temperature thermistor to LVT-22 and 23. A Carrier Comfort Network® (CCN) bus

must be connected between the two chillers. For more information regarding Communication Bus Wiring, see the Carrier Comfort Network® (CCN) Interface section of the Controls, Start-Up, Operation, Service, and Troubleshooting guide.

PART NUMBER	DIMENSIONS in. (mm)	
	A	B
10HB50106801	3.10 (78.7)	1.55 (39.4)
10HB50106802	4.10 (104.1)	1.28 (32.5)

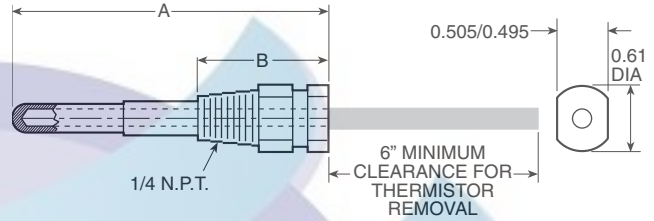
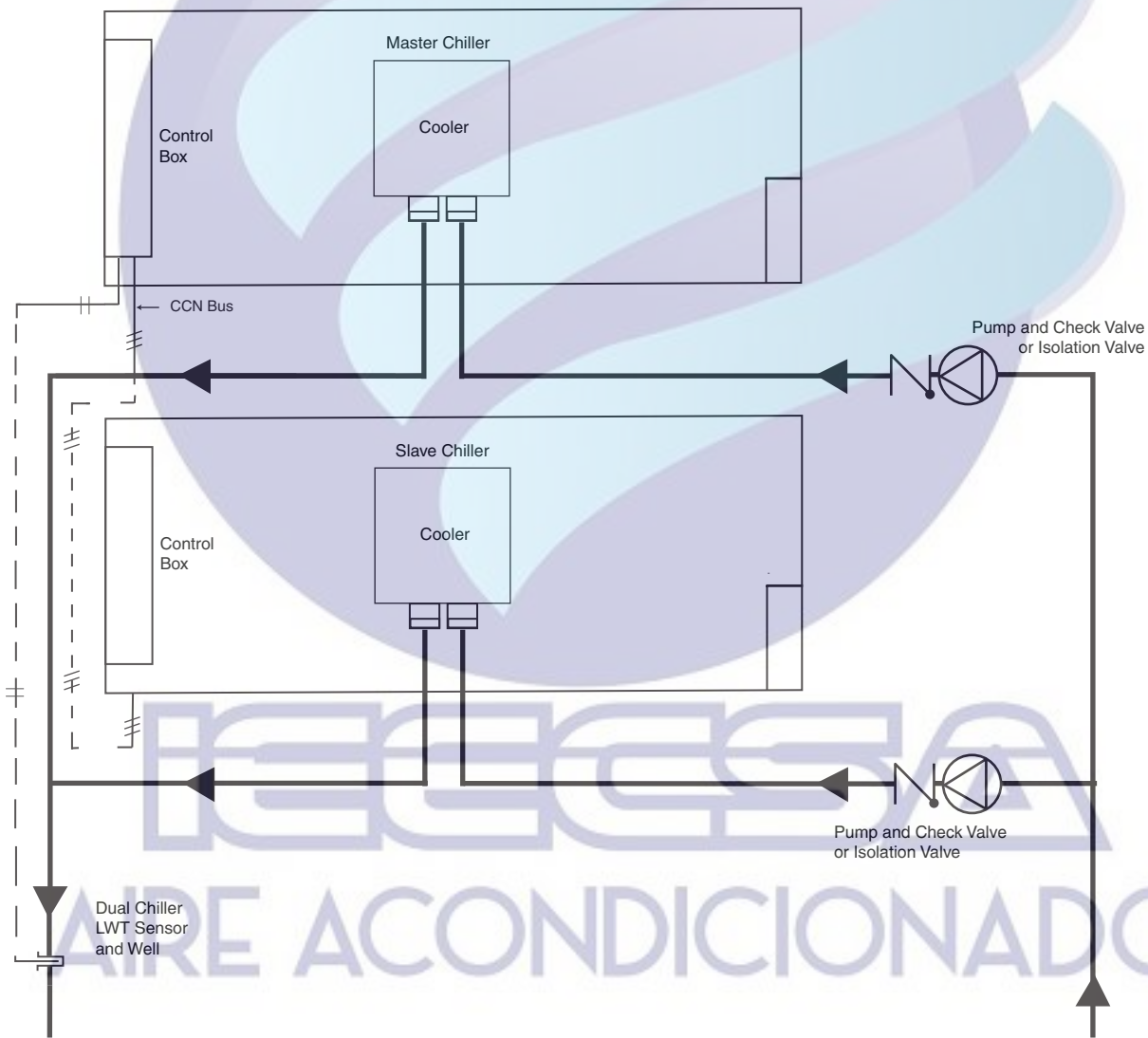

Fig. 20 — Dual Leaving Water Thermistor Well



Depending on piping sizes, use either:

- HH79NZ014 sensor/10HB50106801 (3-in. sensor/well)
- HH79NZ029 sensor/10HB50106802 (4-in. sensor/well)

NOTE: This is a simplified piping diagram—not all hydronic specialties are shown.

LEGEND

- LWT — Leaving Water (Fluid) Temperature
- == — Field Wiring
- == — Field Communication Wiring

Fig. 21 — Dual Chiller Piping Diagram

VICTAULIC COUPLING INSTALLATION

1. The outside surface of the pipe, between the groove and the pipe end, must be smooth and free from indentations, projections (including weld seams), and roll marks to ensure a leak-tight seal. All oil, grease, loose paint, and dirt must be removed.
2. Apply a thin coat of Victaulic lubricant or silicone lubricant to the gasket sealing lips and exterior.

⚠ CAUTION

Always use a compatible lubricant to prevent the gasket from pinching or tearing during installation. Failure to follow this instruction could result in joint leakage.

3. Position the gasket over the pipe end. Make sure the gasket does not overhang the pipe end.
4. Align and bring the two pipe ends together. Slide the gasket into position and center it between the groove in each pipe end. Make sure no portion of the gasket extends into the groove in either pipe end.
5. Install the housings over the gasket.
NOTE: Make sure the housings' keys engage the grooves completely on both pipe ends.

⚠ CAUTION

Make sure the gasket does not become rolled or pinched while installing the housings. Failure to follow this instruction could cause damage to the gasket, resulting in joint leakage.

6. Install the bolts, and thread a nut finger-tight onto each bolt. For couplings supplied with stainless steel hardware, apply an anti-seize compound to the bolt threads. Make sure the oval neck of each bolt seats properly in the bolt hole.
7. Tighten the nuts evenly by alternating sides until metal-to-metal contact occurs at the bolt pads. Make sure the housings' keys engage the grooves completely.
NOTE: It is important to tighten the nuts evenly to prevent gasket pinching.
8. Visually inspect the bolt pads at each joint to ensure metal-to-metal contact is achieved.

UNITS WITH FACTORY-INSTALLED HYDRONIC PACKAGES — The 30RAP chillers with factory-installed hydronic packages are designed for use with closed systems, meaning that there is no more than one water-air interface in the water loop. Cooling tower loops, for example, have two water-air interfaces (sump and nozzles) and would thus be classified as open, whereas a correctly designed chilled water loop with the only water-air interface being in the expansion tank is closed. Since closed and open water systems behave very differently, these instructions assume that the chilled water loop is closed. A system installed incorrectly such that air is not handled properly — pipe leaks, vent leaks, air in pipes, etc. — may behave as an open system and thus have unsatisfactory operation. Pump seal wear can also cause leaks that cause poor system operation.

Proper closed system design and installation procedures should be followed closely. The system must be constructed with pressure-tight components and thoroughly tested for installation leaks. Factory-supplied hydronic systems are available with single or dual (for back-up) pumps.

Figure 22 shows a typical installation with components that might be installed with the hydronic package of the 30RAP unit. The factory-installed system includes all of the components within the dashed lines. Figure 23 illustrates a typical dual pump package for the 011-030 size models.

NOTE: For units with single pumps, it is recommended that isolation (shutoff) valves be placed exterior to the unit to allow removal and service of the entire pump assembly, if necessary. Units with dual pumps have pump isolation valves provided. Also, if the unit is isolated with valves, a properly sized pressure relief valve should be installed in the piping between the unit and the valves, following all applicable state and local codes.

System Pressurization — A proper initial cold fill pressure must be established before the filling of the unit. The initial cold fill pressure is the pressure applied at the filling point to fill a system to its highest point, plus a minimum pressure at the top of the system (4 psi [28 kPa] minimum) to operate air vents and positively pressurize the system.

The compression tank (sometimes called expansion tank) is very important to system pressurization. The compression tank actually serves several purposes:

1. Provides net positive suction head required (NPSHR) for the pump to operate satisfactorily.
2. Sets system pressure.
3. Accommodates expansion/contraction of water due to temperature changes.
4. Acts as a pressure reference for the pump.

ICECSA
AIRE ACONDICIONADO

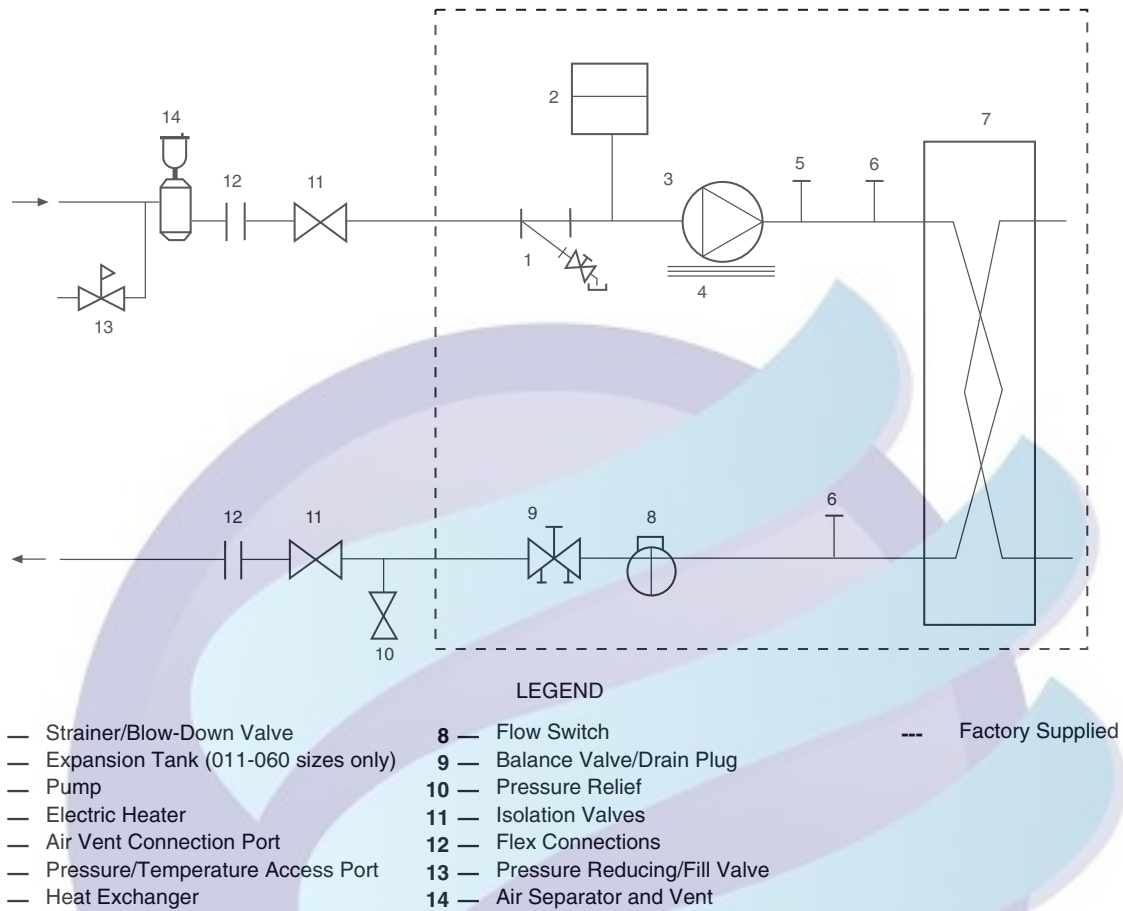
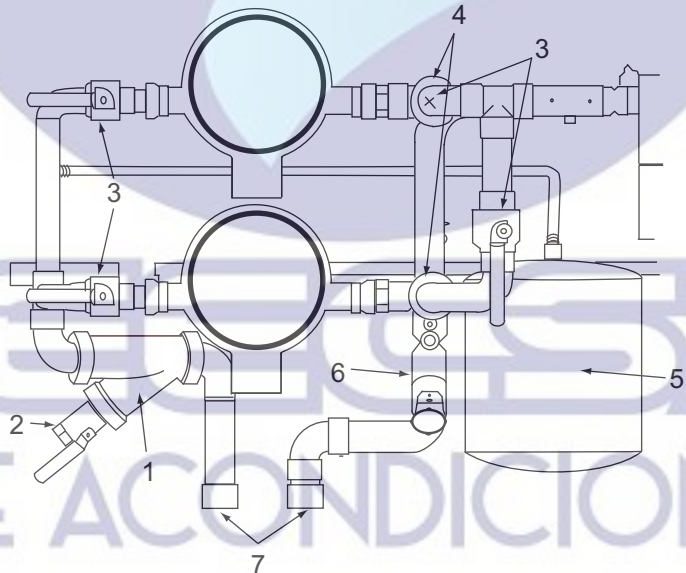

Fig. 22 — Typical Piping Diagram — 30RAP Units with Hydronic Package



- LEGEND**
- | | |
|---|-------------------------------------|
| 1 — Strainer | 5 — Expansion Tank |
| 2 — Blow-Down Valve | 6 — Balancing Valve with Drain Plug |
| 3 — Service Valves | 7 — Field Connections |
| 4 — Discharge Check Valve (Dual Pumps Only) | |

Fig. 23 — Typical Dual Pump Package (011-030 sizes only)

The compression tank pressure must be set BEFORE the system is filled. Expansion tanks are factory supplied on sizes 011-060 only and field supplied on all other sizes. The tanks are pre-charged at the factory to 40 psig (276 kPa). If the 30RAP unit with expansion tank is the high point in the system, tank pre-charge pressure of 40 psig (276 kPa) will be adequate. If the 30RAP unit with expansion tank is NOT at the high point in the system, then the minimum pre-charge pressure for the water system must be determined using Table 8 and the method below:

$$\text{Tank Pressure} = 4 + (\text{height from tank to top of system in feet} \times "X")$$

$$[27.6 + (\text{height in m} \times 22.6 / "X")]$$

For example, assuming a system containing a 20% concentration of ethylene glycol and 50 ft (15.2 m) in height from the top of the system to the expansion tank, the minimum tank pre-charge pressure would be:

$$\text{Tank Pressure} = 4 + (50 / 2.38) = 25.0 \text{ psig}$$

$$= 27.6 + (15.2 \times 22.6 / 2.38) = 171.9 \text{ kPa}$$

Table 8 — “X” Factor for Setting Tank Pressure

% GLYCOL	ETHYLENE GLYCOL	PROPYLENE GLYCOL
0 (pure water)	2.31	2.31
10	2.36	2.33
20	2.38	2.36
30	2.40	2.38
40	2.43	2.38
50	2.47	2.40

NOTE: If expansion tanks are placed elsewhere in the system this method cannot be used since extra pressure drop between the tank and the pump must be accounted for.

NOTE: If the system requires a pre-charge greater than 40 psig (276 kPa), increase pressure as described below.

Expansion Tank Pre-Charge — To pre-charge the expansion tank, do the following steps:

1. Check the tank air pressure at the pre-charge connection with an accurate pressure gage. Adjust as needed.
2. If additional pressure is required, charge the tank with oil-free compressed air or nitrogen gas. Occasionally check the pressure as when filling a tire.
3. Check the air valve for leakage. If it leaks, relieve the pressure and replace the core with a Schrader-type tire core. DO NOT depend on the valve cap to seal the leak.

Once the system is pressurized, the pressure at the connection point of the expansion tank to water piping will not change unless the water loop volume changes (either due to addition/subtraction of water or temperature expansion/contraction). The pressure at this point remains the same regardless of whether or not the pump is running.

Since the expansion tank acts as a reference point for the pump, there cannot be two reference points (two expansion tanks) in a system (unless manifolded together). If system volume or other design considerations warrant the placement of another expansion tank somewhere in the system, the expansion tank in the 30RAP hydronic package MUST be disconnected from its hose and the end of the hose securely plugged.

This is also true for applications where two or more 30RAP chillers are placed in parallel. There should not be more than

one expansion tank in the system (as seen in Fig. 23) unless manifolded together. When multiple 30RAP chillers are applied in parallel, and the chillers include the optional hydronic package which contain expansion tanks (sizes 011-060), the expansion tanks must be disconnected from the 30RAP hydronic package. It is permissible to install the expansion tank(s) in a portion of the return water line that is common to all pumps, providing that the tank is properly sized for combined system volume.

If the application involves two or more chillers in a primary/secondary system, a common place for mounting the expansion tank is in the chilled water return line, just before the decoupler. Refer to Fig. 24 for placement of expansion tank in primary/secondary systems.

The expansion tank included in the 30RAP hydronic package is a diaphragm tank, meaning that a flexible diaphragm physically separates the water/air interface. With this type of expansion tank, it is undesirable to have any air in the water loop. See the section on air separation below for instructions on providing air separation equipment.

AIR SEPARATION — For proper system operation, it is essential that water loops be installed with proper means to manage air in the system. Free air in the system can cause noise, reduce terminal output, stop flow, or even cause pump failure due to pump cavitation. For closed systems, equipment should be provided to eliminate all air from the system.

The amount of air that water can hold in solution depends on the pressure and temperature of the water/air mixture. Air is less soluble at higher temperatures and at lower pressures. Therefore, separation can best be done at the point of highest water temperature and lowest pressure. Typically, this point would be on the suction side of the pump as the water is returning from the system or terminals. Generally speaking, this is the best place to install an air separator, if possible.

1. Install automatic air vents at all high points in the system. (If the 30RAP unit is located at the high point of the system, a vent can be installed on the piping entering the heat exchanger on the ¼-in. NPT female port.)
2. Install an air separator in the water loop, at the place where the water is at higher temperatures and lower pressures — usually in the chilled water return piping. On a primary-secondary system, the highest temperature water is normally in the secondary loop, close to the decoupler. Preference should be given to that point on the system (see Fig. 24). In-line or centrifugal air separators are readily available in the field.

It may not be possible to install air separators at the place of lowest pressure and highest temperature. In such cases, preference should be given to the points of highest temperature. It is important that pipe be sized correctly so that free air can be moved to the point of separation. Generally, a water velocity of at least 2 ft (610 mm) per second will keep free air entrained and prevent it from forming air pockets.

Automatic vents should be installed at all physically elevated points in the system so that air can be eliminated during system operation. Provision should also be made for manual venting during the water loop fill. It is important that the automatic vents be located in accessible locations for maintenance purposes, and that they be located where they can be prevented from freezing.

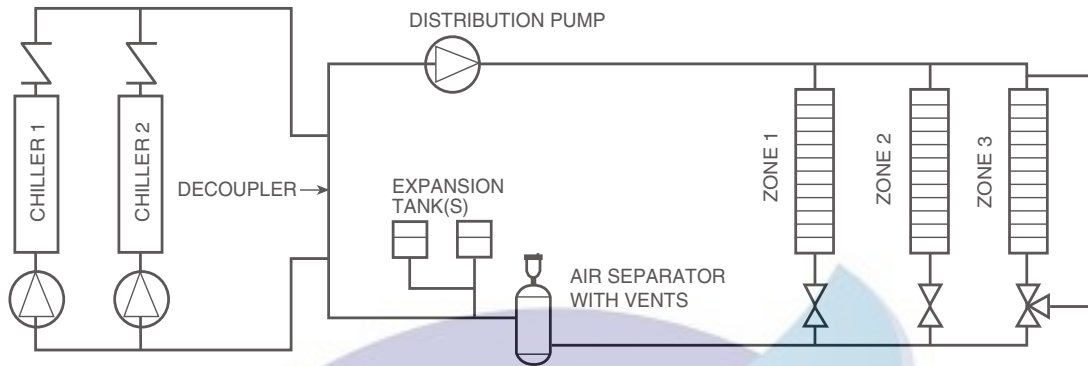

NOTE: Expansion tanks in the 30RAP hydronic kits must be disconnected for chillers placed parallel in the primary water loop.

Fig. 24 — Typical Air Separator and Expansion Tank Location on Primary-Secondary Systems

Step 4 — Fill the Chilled Water Loop

WATER SYSTEM CLEANING — Proper water system cleaning is of vital importance. Excessive particulates in the water system can cause excessive pump seal wear, reduce or stop flow, and cause damage of other components. Water quality should be maintained within the limits indicated in Table 9. Failure to maintain proper water quality may result in heat exchanger failure.

CAUTION

Failure to properly clean all piping and components of the chilled water system before unit start-up may result in plugging of the heat exchanger, which can lead to poor performance, nuisance alarms, and damage from freezing. Freezing damage caused by an improperly cleaned system represents abuse and may impair or otherwise negatively affect the Carrier product warranty.

1. Install a temporary bypass around the chiller to avoid circulating dirty water and particulates into the pump package and chiller during the flush. Use a temporary circulating pump during the cleaning process. Also, be sure that there is capability to fully drain the system after cleaning. (See Fig. 25.)
2. Be sure to use a cleaning agent that is compatible with all system materials. Be especially careful if the system contains any galvanized or aluminum components. Both detergent-dispersant and alkaline-dispersant cleaning agents are available.
3. It is a good idea to fill the system through a water meter. This provides a reference point for the future for loop volume readings, and it also establishes the correct quantity of cleaner needed in order to get the required concentration.
4. Use a feeder/transfer pump to mix the solution and fill the system. Circulate the cleaning system for the length of time recommended by the cleaning agent manufacturer.
 - a. After cleaning, drain the cleaning fluid and flush the system with fresh water.
 - b. A slight amount of cleaning residue in the system can help keep the desired, slightly alkaline, water pH of 8 to 9. Avoid a pH greater than 10, since this will adversely affect pump seal components.
 - c. A side stream filter is recommended (see Fig. 26) during the cleaning process. Filter side flow rate should be enough to filter the entire water volume

every 3 to 4 hours. Change filters as often as necessary during the cleaning process.

- d. Remove temporary bypass when cleaning is complete.

A 40-mesh strainer with a blow-down valve is standard on all 30RAP units, both with and without hydronic packages. The blow-down valve allows removal of particulates caught in the strainer without complete removal of the screen. A female NPT connection is provided on the valve, allowing hose connection for drainage outside the unit.

Carrier's *ComfortLink* controls have a built-in feature to remind building owners or operators to clean the strainer by discharging the blow-down valve at a pre-set time interval. Properly installed and cleaned systems will rarely need the strainer cleaned after the initial fill. This time interval is user-configurable.

Table 9 — Water Quality Characteristics and Limitations

WATER CHARACTERISTIC	QUALITY LIMITATION
Alkalinity (HCO ₃ ⁻)	70 – 300 ppm
Sulfate (SO ₄ ²⁻)	Less than 70 ppm
HCO ₃ ⁻ /SO ₄ ²⁻	Greater than 1.0
Electrical Conductivity	10 – 500 µS/cm
pH	7.5 – 9.0
Ammonia (NH ₃)	Less than 2 ppm
Chlorides (Cl ⁻)	Less than 300 ppm
Free chlorine (Cl ₂)	Less than 1 ppm
Hydrogen Sulfide (H ₂ S)*	Less than 0.05 ppm
Free (aggressive) Carbon Dioxide (CO ₂)†	Less than 5 ppm
Total Hardness (°dH)	4.0 – 8.5
Nitrate (NO ₃)	Less than 100 ppm
Iron (Fe)	Less than 0.2 ppm
Aluminum (Al)	Less than 0.2 ppm
Manganese (Mn)	Less than 0.1 ppm

*Sulfides in the water quickly oxidize when exposed to air, requiring that no agitation occur as the sample is taken. Unless tested immediately at the site, the sample will require stabilization with a few drops of one Molar zinc acetate solution, allowing accurate sulfide determination up to 24 hours after sampling. A low pH and high alkalinity cause system problems, even when both values are within the ranges shown. The term pH refers to the acidity, basicity, or neutrality of the water supply. Below 7.0, the water is considered to be acidic. Above 7.0, water is considered to be basic. Neutral water contains a pH of 7.0.

†Dissolved carbon dioxide can either be calculated from the pH and total alkalinity values, shown below, or measured on the site using a test kit. Dissolved Carbon Dioxide, PPM = TA × 2^[(6.3-pH)/0.3] where TA = Total Alkalinity, PPM as CaCO₃.

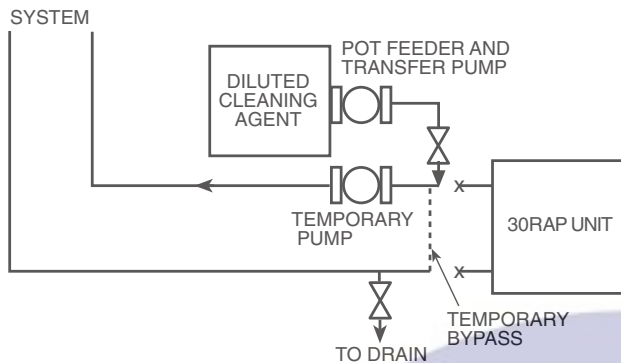

Fig. 25 — Typical Set Up for Cleaning Process

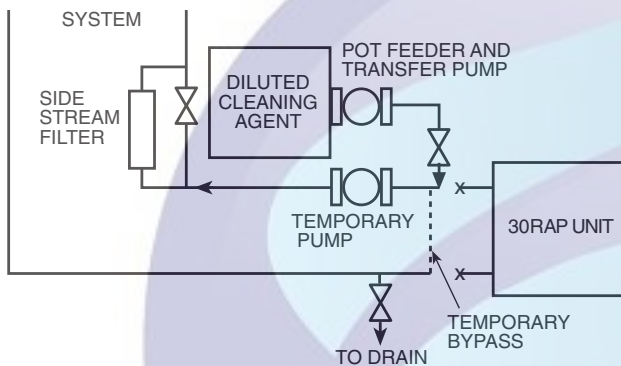

Fig. 26 — Cleaning Using a Side Stream Filter

FILLING THE SYSTEM — The initial fill of the chilled water system must accomplish three purposes:

1. The entire piping system must be filled with water.
2. The pressure at the top of the system must be high enough to vent air from the system (usually 4 psig [28 kPa] is adequate for most vents).
3. The pressure at all points in the system must be high enough to prevent flashing in the piping or cavitation in the pump.

The pressure created by an operating pump affects system pressure at all points except one — the connection of the compression tank to the system. This is the only location in the system where pump operation will not give erroneous pressure indications during the fill. Therefore, the best location to install the fill connection is close to the expansion tank. An air vent should be installed close by to help eliminate air that enters during the fill procedure.

Ensure the following when filling the system:

1. Remove temporary bypass piping and cleaning/flushing equipment.
2. Check to make sure all drain plugs are installed.
3. Open the blow-down valve to flush the strainer.

Normally, a closed system needs to be filled only once. The actual filling process is generally a fairly simple procedure. All air should be purged or vented from the system. Thorough venting at the high points and circulation at room temperature for several hours is recommended.

NOTE: Local codes concerning backflow devices and other protection of the city water system should be consulted and followed to prevent contamination of the public water supply. This is especially important when antifreeze is used in the system.

Set Water Flow Rate — Once the system is cleaned, pressurized, and filled, the flow rate through the chiller must be established. On units with the hydronic package, this can best be done using the balancing valve.

In order to adjust the balancing valve, put a differential pressure gage across the pressure taps on the valve. Make sure that all system isolation and control valves are open. Use Tables 10-13 to determine gpm.

1. Measure the pressure drop across the balancing valve. If the pressure reading is in psig, multiply psig by 2.31 to convert to feet of water before using Tables 10-14.
2. Go to the row in the chart corresponding to the setting on the valve, interpolating if necessary.
3. The gpm corresponding to the pressure drop measured is the flow through the balancing valve.

NOTE: Carrier recommends a differential pressure gage when measuring pressures across the pumps or balancing valves. This provides for greater accuracy and reduces error build-up that often occurs when subtracting pressures made by different gages.

On primary/secondary systems, it is advisable to set the 30RAP balancing valve to maintain design flow plus 10% through the chiller.

A rough estimate of water flow can also be obtained from the pressure gages across the 30RAP heat exchanger. Figures 27-34 show the relationship between gpm and heat exchanger pressure drop. It should be noted that these curves are for “clean” heat exchangers; they do not apply to heat exchangers with fouling. To read the chart, subtract the readings of the two pressure gages on the hydronic kit. This number is the pressure drop across the heat exchanger. Adjust the factory-installed balancing valve or external balancing valve (units without hydronic package) until the correct pressure drop is obtained for the required gpm. Total unit pressure drop is found in Appendix A.

Water Treatment — Fill the fluid loop with water (or suitable inhibited antifreeze solution) and a corrosion-resistant inhibitor suitable for the water of the area. Consult the local water treatment specialist for characteristics of system water and a recommended inhibitor for the cooler fluid loop.

Untreated or improperly treated water may result in corrosion, scaling, erosion, or algae. The services of a qualified water treatment specialist should be obtained to develop and monitor a treatment program.

CAUTION

Water must be within design flow limits, clean, and treated to ensure proper chiller performance and reduce the potential of tube damage due to corrosion, scaling, erosion, and algae. Carrier assumes no responsibility for chiller damage resulting from untreated or improperly treated water.

Table 10 — Balancing Valve Readings — 30RAP011-030

2.0 in. SETTING	VALVE COEFFICIENT (C _v)	WATER PRESSURE DROP (ft)									
		GPM									
		5	10	15	20	25	30	35	40	45	50
0.5	8.3	0.8	3.4	7.5	13.4	21.0	30.2	41.1	53.7	67.9	83.8
1.0	10.2	0.6	2.2	5.0	8.9	13.9	20.0	27.2	35.5	45.0	55.5
1.5	13.0	0.3	1.4	3.1	5.5	8.5	12.3	16.7	21.9	27.7	34.2
2.0	16.9	0.2	0.8	1.8	3.2	5.1	7.3	9.9	12.9	16.4	20.2
2.5	20.5	0.1	0.5	1.2	2.2	3.4	4.9	6.7	8.8	11.1	13.7
3.0	25.9	0.1	0.3	0.8	1.4	2.2	3.1	4.2	5.5	7.0	8.6
3.5	29.0	0.1	0.3	0.6	1.1	1.7	2.5	3.4	4.4	5.6	6.9
4.0	35.8	0.0	0.2	0.4	0.7	1.1	1.6	2.2	2.9	3.6	4.5
5.0	37.0	0.0	0.2	0.4	0.7	1.1	1.5	2.1	2.7	3.4	4.2

2.0 in. SETTING	VALVE COEFFICIENT (C _v)	WATER PRESSURE DROP (ft)									
		GPM									
		55	60	65	70	75	80	85	90	95	100
0.5	8.3	101.4	120.7	141.7	164.3	188.6	214.6	242.3	271.6	302.6	335.3
1.0	10.2	67.2	79.9	93.8	108.8	124.9	142.1	160.4	179.8	200.4	222.0
1.5	13.0	41.3	49.2	57.8	67.0	76.9	87.5	98.8	110.7	123.4	136.7
2.0	16.9	24.5	29.1	34.2	39.6	45.5	51.8	58.4	65.5	73.0	80.9
2.5	20.5	16.6	19.8	23.2	26.9	30.9	35.2	39.7	44.5	49.6	55.0
3.0	25.9	10.4	12.4	14.5	16.9	19.4	22.0	24.9	27.9	31.1	34.4
3.5	29.0	8.3	9.9	11.6	13.5	15.5	17.6	19.8	22.2	24.8	27.5
4.0	35.8	5.5	6.5	7.6	8.8	10.1	11.5	13.0	14.6	16.3	18.0
5.0	37.0	5.1	6.1	7.1	8.3	9.5	10.8	12.2	13.7	15.2	16.9

NOTE: See Table 14 for Glycol Correction Factors.

Table 11 — Balancing Valve Readings — 30RAP035-060

2.5 in. SETTING	VALVE COEFFICIENT (C _v)	WATER PRESSURE DROP (ft)										
		GPM										
		40	45	50	55	60	65	70	75	80	85	90
1.0	15.6	15.2	19.2	23.7	28.7	34.2	40.1	46.5	53.4	60.7	68.6	76.9
2.0	21.1	8.3	10.5	13.0	15.7	18.7	21.9	25.4	29.2	33.2	37.5	42.0
3.0	24.5	6.2	7.8	9.6	11.6	13.9	16.3	18.9	21.6	24.6	27.8	31.2
4.0	38.0	2.6	3.2	4.0	4.8	5.8	6.8	7.8	9.0	10.2	11.6	13.0
4.5	52.0	1.4	1.7	2.1	2.6	3.1	3.6	4.2	4.8	5.5	6.2	6.9
5.0	69.0	0.8	1.0	1.2	1.5	1.7	2.0	2.4	2.7	3.1	3.5	3.9

2.5 in. SETTING	VALVE COEFFICIENT (C _v)	WATER PRESSURE DROP (ft)										
		GPM										
		95	100	105	110	115	120	125	130	135	140	145
1.0	15.6	85.7	94.9	104.7	114.9	125.5	136.7	148.3	160.4	173.0	186.0	199.6
2.0	21.1	46.8	51.9	57.2	62.8	68.6	74.7	81.1	87.7	94.6	101.7	109.1
3.0	24.5	34.7	38.5	42.4	46.6	50.9	55.4	60.1	65.0	70.1	75.4	80.9
4.0	38.0	14.4	16.0	17.6	19.4	21.2	23.0	25.0	27.0	29.2	31.4	33.6
4.5	52.0	7.7	8.5	9.4	10.3	11.3	12.3	13.3	14.4	15.6	16.7	18.0
5.0	69.0	4.4	4.9	5.3	5.9	6.4	7.0	7.6	8.2	8.8	9.5	10.2

2.5 in. SETTING	VALVE COEFFICIENT (C _v)	WATER PRESSURE DROP (ft)										
		GPM										
		150	155	160	165	170	175	180	185	190	195	200
1.0	15.6	213.6	228.0	243.0	258.4	274.3	290.7	307.5	324.9	342.7	360.9	379.7
2.0	21.1	116.7	124.7	132.8	141.3	149.9	158.9	168.1	177.6	187.3	197.3	207.5
3.0	24.5	86.6	92.5	98.5	104.8	111.2	117.9	124.7	131.7	138.9	146.3	153.9
4.0	38.0	36.0	38.4	41.0	43.6	46.2	49.0	51.8	54.8	57.8	60.8	64.0
4.5	52.0	19.2	20.5	21.9	23.3	24.7	26.2	27.7	29.2	30.8	32.5	34.2
5.0	69.0	10.9	11.7	12.4	13.2	14.0	14.9	15.7	16.6	17.5	18.4	19.4

NOTE: See Table 14 for Glycol Correction Factors.

Table 12 — Balancing Valve Readings — 30RAP070-090

3.0 in. STRAIGHT SETTING	VALVE COEFFICIENT (C _v)	WATER PRESSURE DROP (ft)												
		GPM												
		70	80	90	100	110	120	130	140	150	160	170	180	190
1.0	20.0	28.3	37.0	46.8	57.8	69.9	83.2	97.6	113.2	129.9	147.8	166.9	187.1	208.5
1.5	22.9	21.6	28.2	35.7	44.0	53.3	63.4	74.4	86.3	99.1	112.8	127.3	142.7	159.0
2.0	25.6	17.3	22.6	28.6	35.2	42.6	50.8	59.6	69.1	79.3	90.2	101.9	114.2	127.2
2.5	27.0	15.5	20.3	25.7	31.7	38.3	45.6	53.6	62.1	71.3	81.1	91.6	102.7	114.4
3.0	30.0	12.6	16.4	20.8	25.7	31.1	37.0	43.4	50.3	57.8	65.7	74.2	83.2	92.7
3.5	36.5	8.5	11.1	14.0	17.3	21.0	25.0	29.3	34.0	39.0	44.4	50.1	56.2	62.6
4.0	56.0	3.6	4.7	6.0	7.4	8.9	10.6	12.4	14.4	16.6	18.9	21.3	23.9	26.6
4.5	76.0	2.0	2.6	3.2	4.0	4.8	5.8	6.8	7.8	9.0	10.2	11.6	13.0	14.4
5.0	94.5	1.3	1.7	2.1	2.6	3.1	3.7	4.4	5.1	5.8	6.6	7.5	8.4	9.3

3.0 in. STRAIGHT SETTING	VALVE COEFFICIENT (C _v)	WATER PRESSURE DROP (ft)												
		GPM												
		200	210	220	230	240	250	260	270	280	290	300	310	320
1.0	20.0	231.0	254.7	279.5	305.5	332.6	360.9	390.4	421.0	452.8	485.7	519.8	555.0	591.4
1.5	22.9	176.2	194.3	213.2	233.0	253.7	275.3	297.8	321.1	345.3	370.5	396.4	423.3	451.1
2.0	25.6	141.0	155.4	170.6	186.5	203.0	220.3	238.3	257.0	276.3	296.4	317.2	338.7	360.9
2.5	27.0	126.7	139.7	153.4	167.6	182.5	198.0	214.2	231.0	248.4	266.5	285.2	304.5	324.5
3.0	30.0	102.7	113.2	124.2	135.8	147.8	160.4	173.5	187.1	201.2	215.9	231.0	246.7	262.8
3.5	36.5	69.4	76.5	83.9	91.7	99.9	108.4	117.2	126.4	135.9	145.8	156.1	166.6	177.6
4.0	56.0	29.5	32.5	35.7	39.0	42.4	46.0	49.8	53.7	57.8	61.9	66.3	70.8	75.4
4.5	76.0	16.0	17.6	19.4	21.2	23.0	25.0	27.0	29.2	31.4	33.6	36.0	38.4	41.0
5.0	94.5	10.3	11.4	12.5	13.7	14.9	16.2	17.5	18.9	20.3	21.8	23.3	24.9	26.5

3.0 in. STRAIGHT SETTING	VALVE COEFFICIENT (C _v)	WATER PRESSURE DROP (ft)												
		GPM												
		330	340	350	360	370	380	390	400	410	420	430	440	450
1.0	20.0	628.9	667.6	707.4	748.4	790.6	833.9	878.4	924.0	970.8	1018.7	1067.8	1118.0	1169.4
1.5	22.9	479.7	509.2	539.6	570.9	603.0	636.1	670.0	704.8	740.5	777.0	814.5	852.8	892.0
2.0	25.6	383.8	407.5	431.8	456.8	482.5	509.0	536.1	564.0	592.5	621.8	651.7	682.4	713.8
2.5	27.0	345.1	366.3	388.2	410.7	433.8	457.6	482.0	507.0	532.7	559.0	585.9	613.5	641.7
3.0	30.0	279.5	296.7	314.4	332.6	351.4	370.6	390.4	410.7	431.5	452.8	474.6	496.9	519.8
3.5	36.5	188.8	200.4	212.4	224.7	237.4	250.4	263.7	277.4	291.5	305.9	320.6	335.7	351.1
4.0	56.0	80.2	85.2	90.2	95.5	100.8	106.4	112.0	117.9	123.8	129.9	136.2	142.6	149.2
4.5	76.0	43.6	46.2	49.0	51.8	54.8	57.8	60.8	64.0	67.2	70.5	73.9	77.4	81.0
5.0	94.5	28.2	29.9	31.7	33.5	35.4	37.4	39.3	41.4	43.5	45.6	47.8	50.1	52.4

NOTE: See Table 14 for Glycol Correction Factors.



Table 13 — Balancing Valve Readings — 30RAP100-150

4.0 in. STRAIGHT SETTING	VALVE COEFFICIENT (Cv)	WATER PRESSURE DROP (ft)													
		GPM													
		80	90	100	110	120	130	140	150	160	170	180	190	200	
1.0	21.5	32.0	40.5	50.0	60.5	72.0	84.5	97.9	112.4	127.9	144.4	161.9	180.4	199.9	
1.5	25.0	23.7	29.9	37.0	44.7	53.2	62.5	72.4	83.2	94.6	106.8	119.8	133.4	147.8	
2.0	27.2	20.0	25.3	31.2	37.8	45.0	52.8	61.2	70.3	79.9	90.2	101.2	112.7	124.9	
2.5	43.0	8.0	10.1	12.5	15.1	18.0	21.1	24.5	28.1	32.0	36.1	40.5	45.1	50.0	
3.0	68.0	3.2	4.0	5.0	6.0	7.2	8.4	9.8	11.2	12.8	14.4	16.2	18.0	20.0	
3.5	100.0	1.5	1.9	2.3	2.8	3.3	3.9	4.5	5.2	5.9	6.7	7.5	8.3	9.2	
4.0	129.0	0.9	1.1	1.4	1.7	2.0	2.3	2.7	3.1	3.6	4.0	4.5	5.0	5.6	
4.5	162.0	0.6	0.7	0.9	1.1	1.3	1.5	1.7	2.0	2.3	2.5	2.9	3.2	3.5	
5.0	190.0	0.4	0.5	0.6	0.8	0.9	1.1	1.3	1.4	1.6	1.8	2.1	2.3	2.6	
5.5	216.0	0.3	0.4	0.5	0.6	0.7	0.8	1.0	1.1	1.3	1.4	1.6	1.8	2.0	
6.0	249.0	0.2	0.3	0.4	0.5	0.5	0.6	0.7	0.8	1.0	1.1	1.2	1.3	1.5	

4.0 in. STRAIGHT SETTING	VALVE COEFFICIENT (Cv)	WATER PRESSURE DROP (ft)													
		GPM													
		210	220	230	240	250	260	270	280	290	300	310	320	330	
1.0	21.5	220.4	241.9	264.4	287.8	312.3	337.8	364.3	391.8	420.3	449.8	480.2	511.7	544.2	
1.5	25.0	163.0	178.9	195.5	212.9	231.0	249.8	269.4	289.8	310.8	332.6	355.2	378.5	402.5	
2.0	27.2	137.7	151.1	165.2	179.8	195.1	211.1	227.6	244.8	262.6	281.0	300.1	319.7	340.0	
2.5	43.0	55.1	60.5	66.1	72.0	78.1	84.5	91.1	97.9	105.1	112.4	120.1	127.9	136.1	
3.0	68.0	22.0	24.2	26.4	28.8	31.2	33.8	36.4	39.2	42.0	45.0	48.0	51.2	54.4	
3.5	100.0	10.2	11.2	12.2	13.3	14.4	15.6	16.8	18.1	19.4	20.8	22.2	23.7	25.2	
4.0	129.0	6.1	6.7	7.3	8.0	8.7	9.4	10.1	10.9	11.7	12.5	13.3	14.2	15.1	
4.5	162.0	3.9	4.3	4.7	5.1	5.5	6.0	6.4	6.9	7.4	7.9	8.5	9.0	9.6	
5.0	190.0	2.8	3.1	3.4	3.7	4.0	4.3	4.7	5.0	5.4	5.8	6.1	6.6	7.0	
5.5	216.0	2.2	2.4	2.6	2.9	3.1	3.3	3.6	3.9	4.2	4.5	4.8	5.1	5.4	
6.0	249.0	1.6	1.8	2.0	2.1	2.3	2.5	2.7	2.9	3.1	3.4	3.6	3.8	4.1	

4.0 in. STRAIGHT SETTING	VALVE COEFFICIENT (Cv)	WATER PRESSURE DROP (ft)													
		GPM													
		340	350	360	370	380	390	400	410	420	430	440	450		
1.0	21.5	577.7	612.2	647.6	684.1	721.6	760.1	799.6	840.0	881.5	924.0	967.5	1012.0		
1.5	25.0	427.3	452.8	479.0	506.0	533.7	562.2	591.4	621.3	652.0	683.4	715.5	748.4		
2.0	27.2	360.9	382.5	404.6	427.4	450.9	474.9	499.6	524.9	550.8	577.3	604.5	632.3		
2.5	43.0	144.4	153.0	161.9	171.0	180.4	190.0	199.9	210.0	220.4	231.0	241.9	253.0		
3.0	68.0	57.8	61.2	64.7	68.4	72.1	76.0	79.9	84.0	88.1	92.4	96.7	101.2		
3.5	100.0	26.7	28.3	29.9	31.6	33.4	35.1	37.0	38.8	40.7	42.7	44.7	46.8		
4.0	129.0	16.0	17.0	18.0	19.0	20.0	21.1	22.2	23.3	24.5	25.7	26.9	28.1		
4.5	162.0	10.2	10.8	11.4	12.0	12.7	13.4	14.1	14.8	15.5	16.3	17.0	17.8		
5.0	190.0	7.4	7.8	8.3	8.8	9.2	9.7	10.2	10.8	11.3	11.8	12.4	13.0		
5.5	216.0	5.7	6.1	6.4	6.8	7.1	7.5	7.9	8.3	8.7	9.2	9.6	10.0		
6.0	249.0	4.3	4.6	4.8	5.1	5.4	5.7	6.0	6.3	6.6	6.9	7.2	7.5		

NOTE: See Table 14 for Glycol Correction Factors.

Table 14 — Glycol Correction Factors

CONCENTRATION	GLYCOL CORRECTION FACTOR			
	Ethylene		Propylene	
	Water Temp — °F (°C)			
	40 (4.5)	70 (21)	40 (4.5)	70 (21)
0	1.00	1.00	1.00	1.00
10	0.99	0.99	0.99	0.99
20	0.99	0.99	0.99	0.99
30	0.98	0.98	0.99	0.99
40	0.97	0.97	0.98	0.98
50	0.96	0.96	0.97	0.98

Glycol Corrections:

GPM [actual] = GPM [tested] x Correction Factor

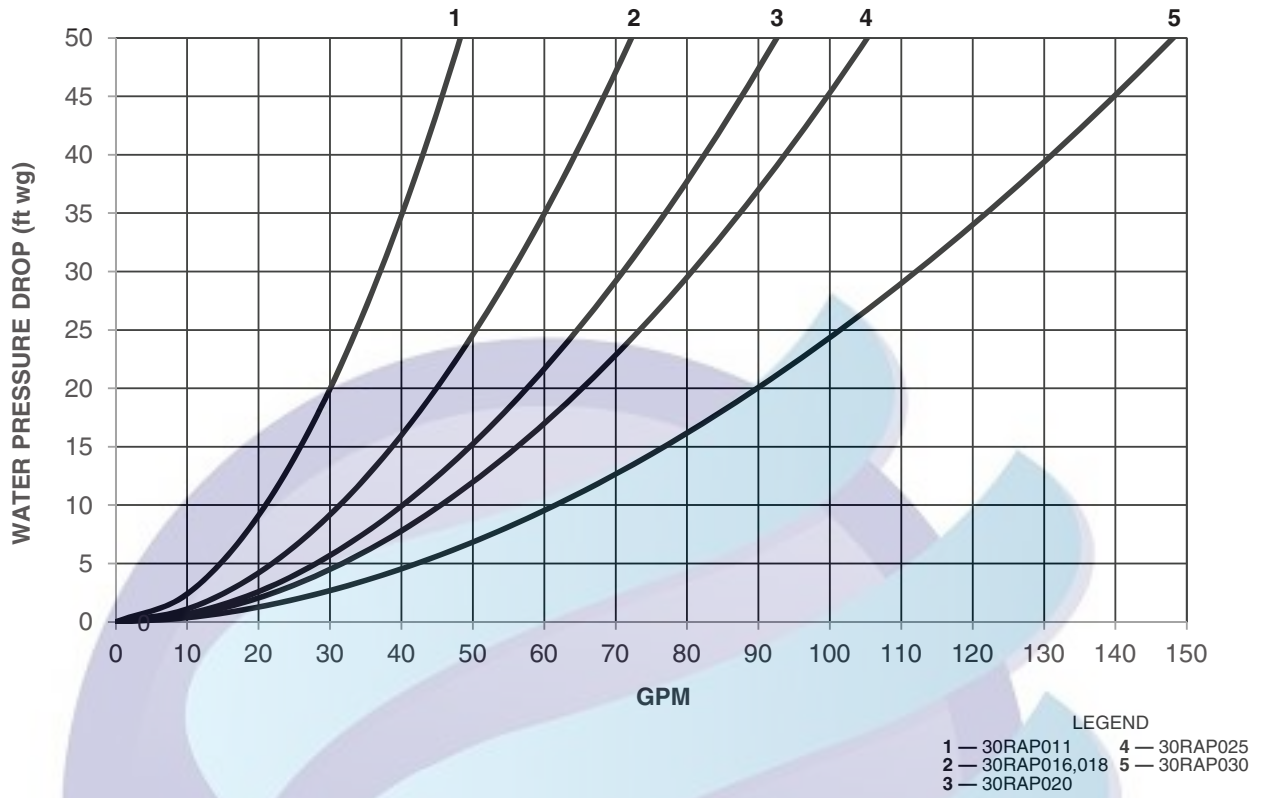

Fig. 27 — Heat Exchanger Pressure Drop (Water Only) — 30RAP011-030 (English)

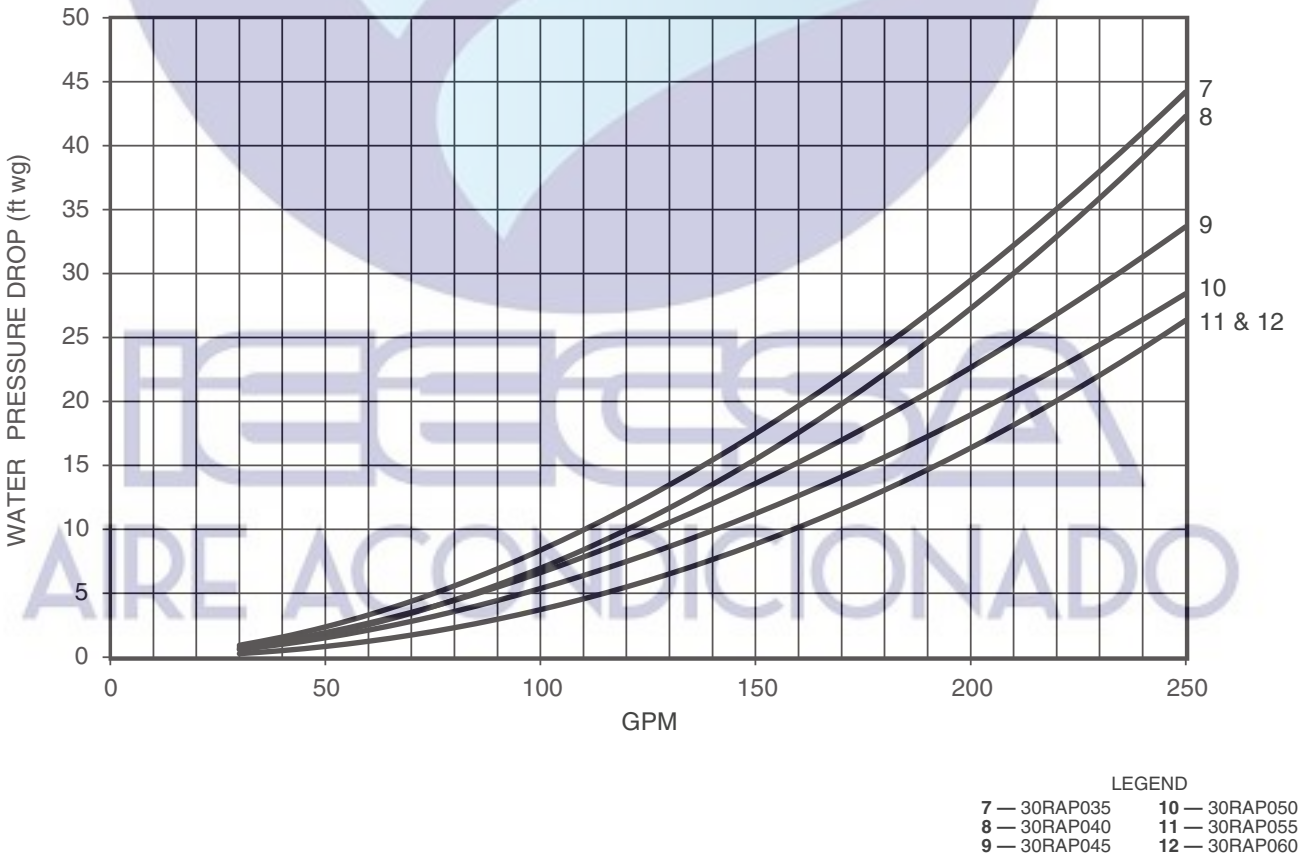

Fig. 28 — Heat Exchanger Pressure Drop (Water Only) — 30RAP035-060 (English)

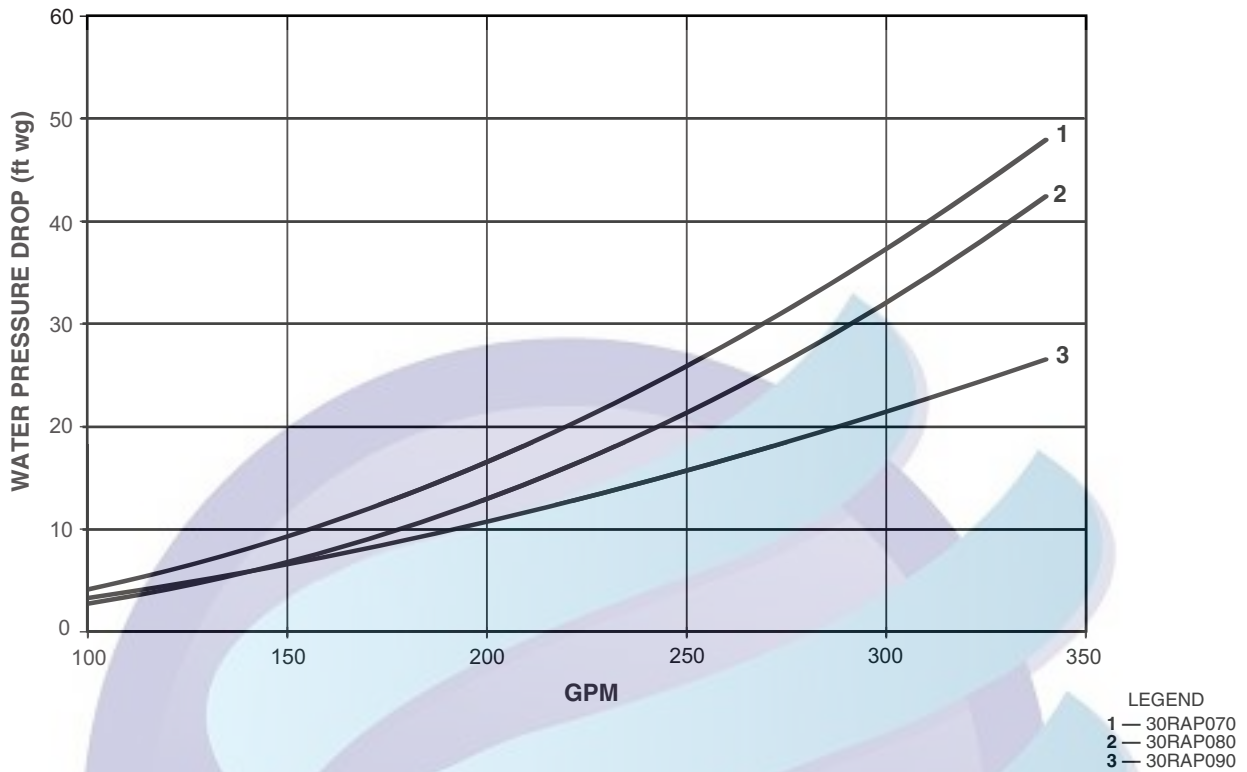

Fig. 29 — Heat Exchanger Pressure Drop (Water Only) — 30RAP070-090 (English)

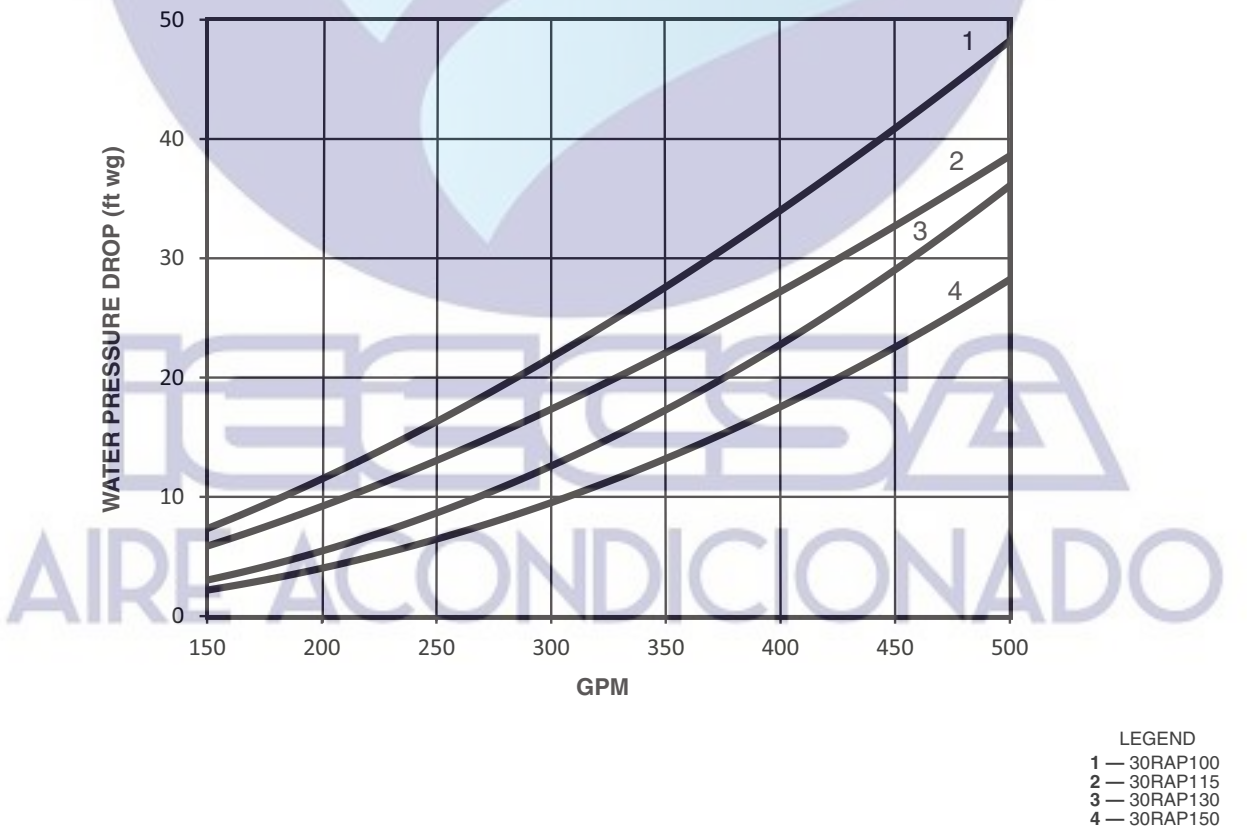

Fig. 30 — Heat Exchanger Pressure Drop (Water Only) — 30RAP100-150 (English)

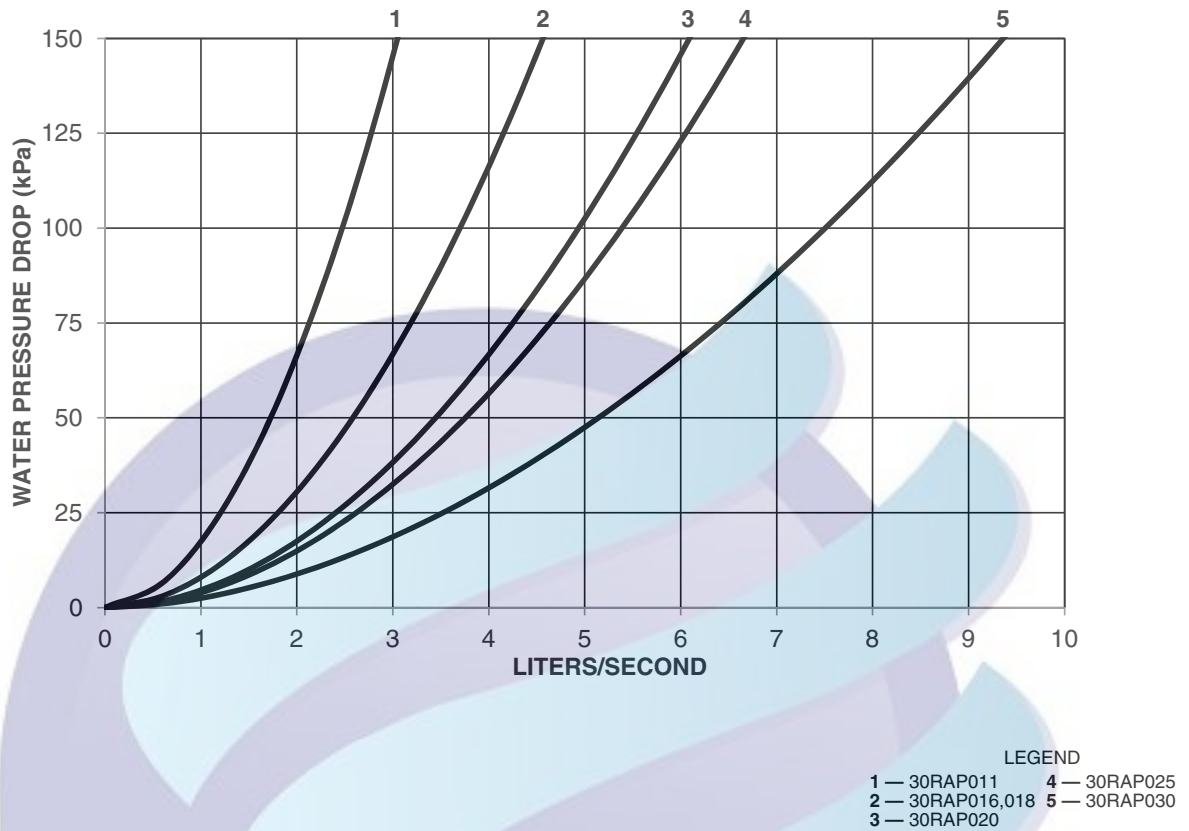

Fig. 31 — Heat Exchanger Pressure Drop (Water Only) — 30RAP011-030 (SI)

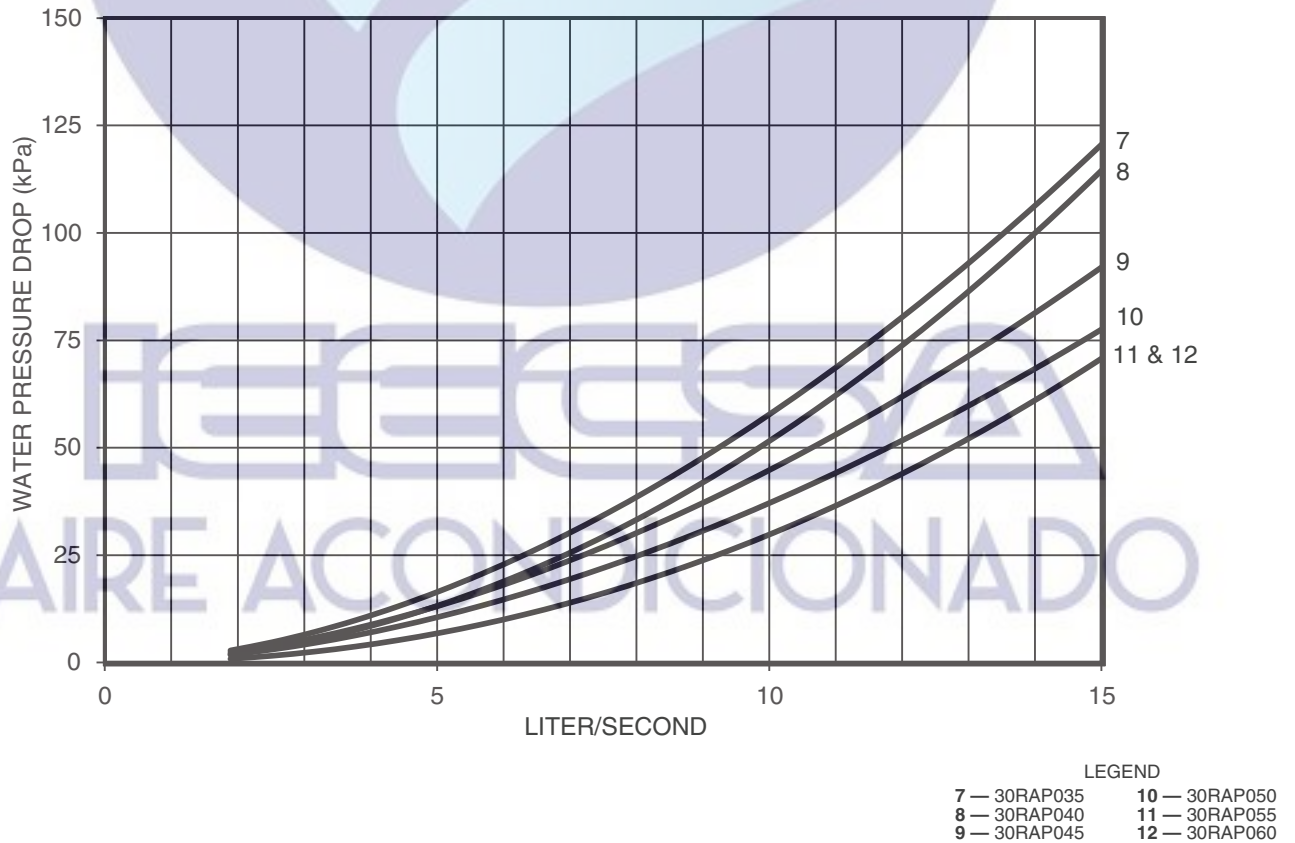

Fig. 32 — Heat Exchanger Pressure Drop (Water Only) — 30RAP035-060 (SI)

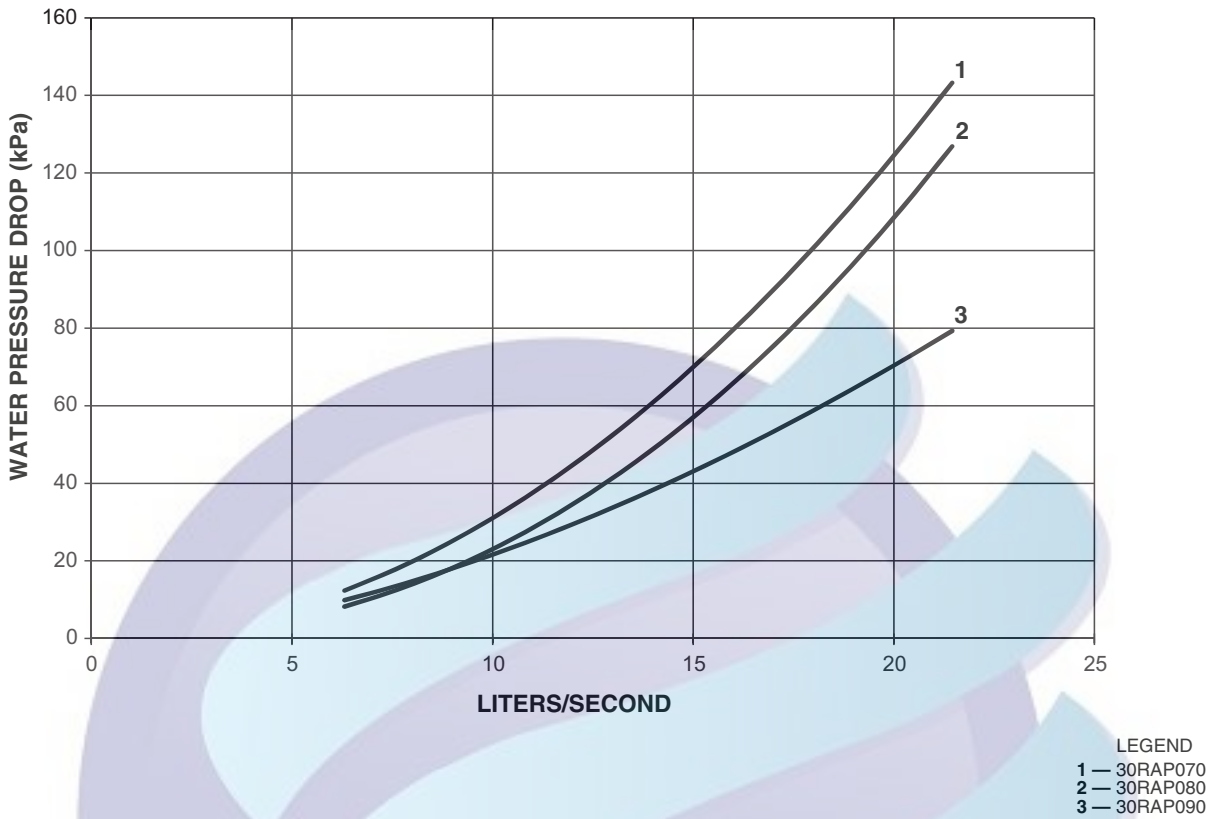

Fig. 33 — Heat Exchanger Pressure Drop (Water Only) — 30RAP070-090 (SI)

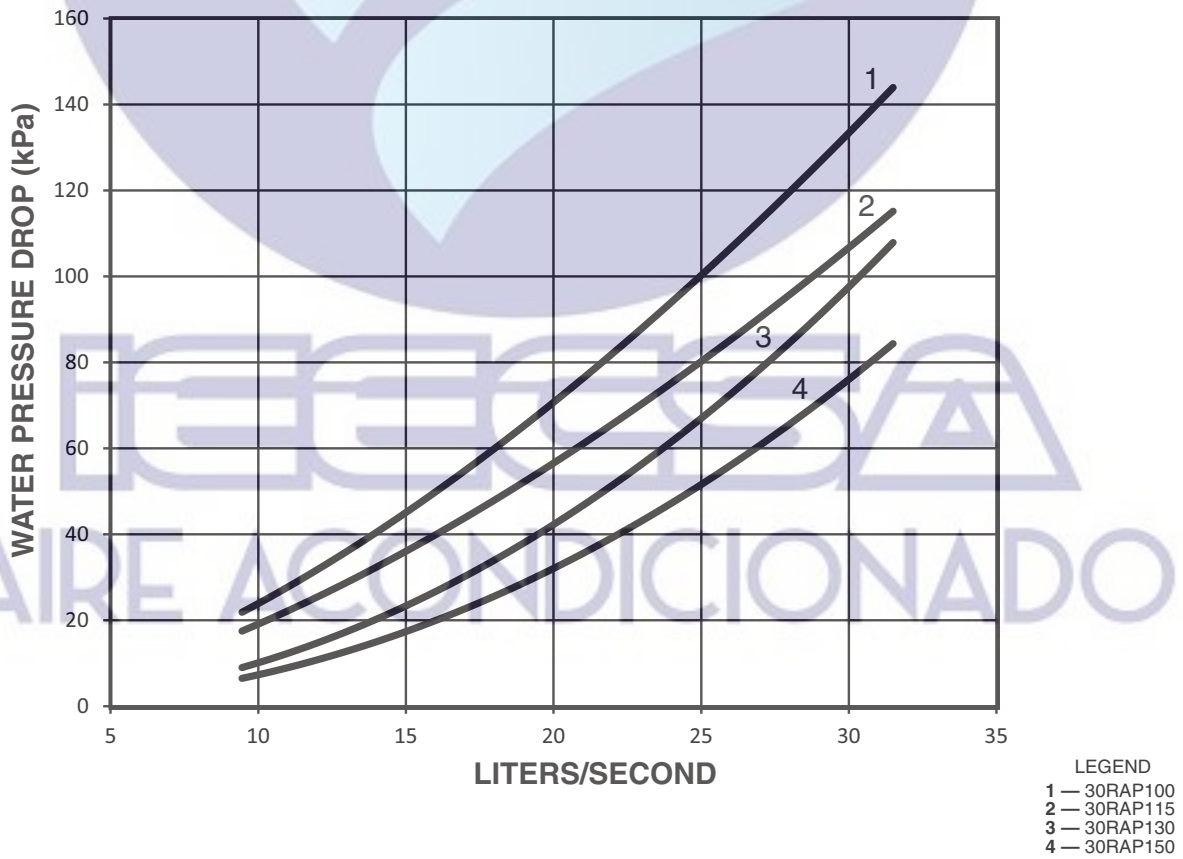

Fig. 34 — Heat Exchanger Pressure Drop (Water Only) — 30RAP100-150 (SI)

Minimum Loop Volume — The minimum volume of fluid required to be in circulation is a function of the number of compressors in the chiller as well as the type of application. The minimum fluid in circulation must equal or exceed the values in Table 15.

To achieve this fluid volume, it is often necessary to install a tank in the loop. The tank should be baffled to ensure there is no stratification and that water (or suitable inhibited antifreeze solution) entering the tank is adequately mixed with liquid in the tank. See Fig. 35.

Table 15 — Minimum Fluid Volume In Circulation

30RAP UNIT SIZE	NORMAL AIR CONDITIONING APPLICATION gal./ton (L per kW)			PROCESS COOLING OR LOW AMBIENT OPERATION APPLICATION gal./ton (L per kW)		
	Std Unit	HGBP	Digital	Std Unit	HGBP	Digital
011-016	12 (13.0)	N/A	3 (3.3)	12 (13.0)	N/A	6 (6.5)
018-030	6 (6.5)	4 (4.3)	3 (3.3)	10 (10.8)	10 (10.8)	6 (6.5)
035-150	3 (3.3)	3 (3.3)	3 (3.3)	6 (6.5)	6 (6.5)	6 (6.5)

LEGEND

HGBP — Hot Gas Bypass

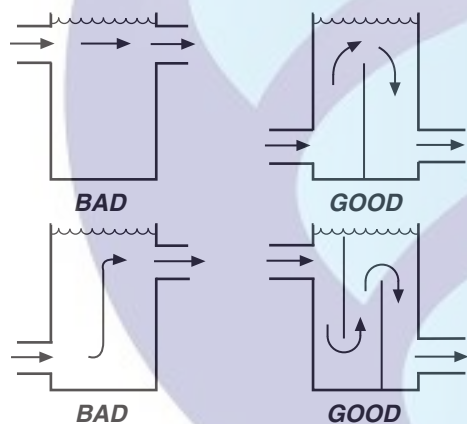

Fig. 35 — Tank Baffling

The piping between the chiller and the accessory tank can be done to allow the tank to be on the return side of the chiller (tank piped to chiller inlet) or the supply side of the chiller (tank piped to chiller outlet). For standard compressors, it is recommended that the tank be piped to the return side of the chiller to buffer any changes in load to allow more stable chiller operation. For digital compressor applications, it is recommended that the tank be piped to the supply side of the chiller to provide a more stable supply temperature.

A properly baffled storage tank is available from the factory as an accessory for sizes 011-060 only. These tanks are designed to physically fit beneath the corresponding 30RAP unit, taking up the same footprint.

- 30RAP011, 016 83 gallons (314 liters)
- 30RAP018-030 119 gallons (450 liters)
- 30RAP035-060 241 gallons (912 liters)

Storage tank weight (water weight included) is as follows:

- 30RAP011, 016 1673 lb (759 kg)
- 30RAP018-030 2193 lb (995 kg)
- 30RAP035-060 4361 lb (1978 kg)

Maximum Loop Volume (Units with Hydronic Package) — Since the minimum size of the expansion tank is dependent upon loop volume, units with the integrated hydronic kit must not exceed the maximum loop volume limits (see Table 16).

The limits are dependent on the maximum and minimum temperatures of the water, the maximum and minimum pressures seen by the expansion tank, and the heat transfer fluid. Expansion tank and maximum loop volume data is as follows:

	30RAP011-030	30RAP035-060
Volume gal. (L)	5.0 (18.9)	10.0 (37.9)
Acceptance Volume gal. (L)	2.9 (11.0)	5.5 (20.8)

Table 16 — Maximum Loop Volume

CONCENTRATION	30RAP011-030		30RAP035-060	
	GAL.	L	GAL.	L
PURE WATER	230	871	738	2793
10% EG	132	500	425	1609
20% EG	123	466	394	1491
30% EG	114	431	366	1385
40% EG	107	405	342	1294
10% PG	124	469	399	1510
20% PG	106	401	339	1283
30% PG	93	352	298	1128
40% PG	83	314	267	1011

LEGEND

EG — Ethylene Glycol
PG — Propylene Glycol

NOTE: Maximum loop volume is based on typical system of 12 psig (83 kPa) and 30 psig (207 kPa) of min/max pressures, and 38°F (3.3°C) and 100°F (37.8°C) min/max water temperature. If the volume in the system is greater than the limits listed, then extra expansion tank volume must be added to the system.

Pump Modification/Trimming (Units with Factory-Installed Hydronic Package) — Since the pumps are constant speed, the only way to obtain greater flow with a given pump/impeller is to decrease system head. This will allow the pump to “ride” its curve to the right, resulting in increased flow. If greater flow is necessary, look at opening the balance valve. Also, verify that the strainer is clean, and that no unnecessary system resistance is present, such as partially closed isolation valves.

Increasing system resistance by closing the balancing valve will force the pump to “ride” its curve to the left, resulting in less flow. Although this does reduce power consumption slightly, it may not be the desirable method of reducing the flow, especially if a rather large reduction is needed.

The other method for reducing flow on a constant speed pump is impeller trimming. The impellers in the pumps provided in the 30RAP hydronic kit are easily removable for this purpose. Refer to the pump literature packet supplied with the hydronic package information on Seal Replacement in the Service Section, and follow its instructions for impeller removal. Trimming should only be done by a qualified machine shop that has experience in this operation. Contact your local Carrier representative for a recommended machine shop. After trimming, the impeller MUST be balanced. Failure to balance trimmed impellers can result in excessive vibration, noise, and premature bearing failure. Impeller trimming has the added benefit of maximum bhp savings.

Power savings may pay for the trimming cost very quickly. The 30RAP pump option may be applied with a field-supplied VFD. When applied with a VFD, the maximum length of wiring between the drive and the pump motor is 50 ft (15.2 m). The maximum allowable carrier frequency of the inverter is 12 kHz, with 3 kHz recommended.

PUMP VFD — Pumps may be ordered with a variable frequency drive (VFD) for speed control (sizes 070-150 only). Armstrong pump VFD password is 00002323 to allow access to parameters.

SENSORLESS CONTROL (CLOSED LOOP) — ACTIVE SETUP 1 — The VFD provided with the pump from the factory is configured for sensorless control. Default set points are entered for the unit according to nominal tonnage of the unit. Table 17 shows the settings from the factory. For details on operating the drive display, see the pump installation and operation manual, and for more detailed information on the drive, see IVS 102 Operating Instructions. These manuals are supplied in the control box of the chiller.

The following set points should be verified or modified for the actual installation.

- Parameter 20-21 Setpoint, Hd, Ft-Wc
- Parameter 22-89 Design Flow Setpoint, GPM
- Parameter 22-87 Pressure at no-flow speed, Hmin, Ft-Wc (40% of Hd)

When changing set points, assure values are within the pump curve for the pump provided with the unit.

Minimum speed for the pump is set at 50 Hz, Parameter 4-12. This may be changed as long as the corresponding flow rate meets the minimum flow requirement for the chiller.

REMOTE SENSOR (CLOSED LOOP) — ACTIVE SETUP 2 — The drive may be set up to use a remote sensor instead of sensorless pump control. For a remote sensor

control change Active Setup on the drive from 1 to 2, Parameter 0-10. The drive will read a 0-10 vdc or a 0/4-20 mA signal from the sensor. Switch S2-01 must be set to Off (default setting) for 0-10 vdc or On for 0/4-20 mA. The switch is located behind the display. The cover must be removed and the display will snap off to access this switch.

The set point is defined by Parameter 20-21, Setpoint 1. This is a percentage of the maximum signal from the sensor. The default is 80%.

REMOTE CONTROLLER (OPEN LOOP) — ACTIVE SETUP 3 — Drive may be controlled by external sources. For a remote control of the drive change Active Setup on the drive to 3, Parameter 0-10, and change Parameter 1-00 to 0 (open loop). An input signal can be used to control the drive speed. Input signal may be 0-10 vdc or 0/4-20 mA. The setup is the same as a remote sensor.

A BACnet¹ card is also included with the drive. For BACnet, use Setup 3. The communication settings are in section 8 of the drive parameters. See drive manual for details.

1. BACnet is a registered trademark of ASHRAE (American Society of Heating, Refrigerating, and Air-Conditioning Engineers).

Table 17 — Default Settings for Sensorless Control — Setup 1

SINGLE PUMP																	
Unit Size (tons)				070		080, 090, 100				115,130				150			
Hydronic System Option				F	G	D	F	G	H	D	F	G	H	D	F	G	H
Pump Number				4360 3D		4380 3x3x5		4360 3D		4380 3x3x6				4380 4x4x8		4380 4x4x6	
HP				7.5	10	7.5		15		5	7.5	10	15	5	7.5	10	15
Impeller Dia (in.)				5.25	5.75	5.25		6.5		4.5	5.0	5.4	6.1	6.5	7.4	4.6	5.2
Param.	Desc.																
20-21	Setpoint 1	Hd	ft wc	55	95	50		120		35	45	80	115	25	50	70	95
22-89	Flow at Design Point		gpm	170		200				300				340			
22-87	Press at No Flow Speed	40%Hd	ft wc	22	38	20		48		14	18	32	46	10	20	28	38

DUAL PUMP																					
Unit Size (tons)				070				080, 090, 100				115, 130				150					
Hydronic System Option				J	K	L	M	K	L	M	N	K	L	M	N	L	M	N			
Pump Number				4382 4x4x8		4382 4x4x6		4382 3x3x6		4382 4x4x6				4382 4x4x6				4382 4x4x6			
HP				3	5	7.5	10	5	7.5	10	15	5	7.5	10	15	7.5	10	15			
Impeller Dia (in.)				6.5	4.5	5.25	5.9	4.5	5.0	5.4	6.0	4.5	5.0	5.4	6.0	5.0	5.4	6.0			
Param.	Desc.																				
20-21	Setpoint 1	Hd	ft wc	30	45	55	95	40	50	90	120	35	45	80	115	50	70	95			
22-89	Flow at Design Point		gpm	170				200				300				340					
22-87	Press at No Flow Speed	40%Hd	ft wc	12	18	22	38	16	20	36	48	14	18	32	46	14	18	32			

PREPARATION FOR YEAR-ROUND OPERATION — If the unit is in operation year-round, add sufficient suitable inhibited antifreeze solution such as propylene or ethylene glycol to chilled water to prevent freezing under low-ambient temperature operating conditions. Consult a local water treatment specialist on characteristics of water and recommended inhibitor.

IMPORTANT: Glycol antifreeze solutions are highly recommended since heater tapes provide no protection in the event of a power failure.

Motormaster® low ambient temperature head pressure control is required if ambient temperatures are below 45°F (7°C) on size 018-030 units, and 32°F (0°C) on size 035-150 units. The Motormaster low ambient control option is not available on any unit which employs high-efficiency variable condenser fans (because units with such fans already have low ambient capability).

Accessory wind baffles are required with Motormaster head pressure control and high-efficiency variable condenser fans if the wind velocity is anticipated to be greater than 5 mph (8 km/h). Unit sizes 011-030 require one baffle and unit sizes 035-060 require two baffles. Unit sizes 070-150 require one baffle. See Table 18.

Table 18 — Wind Baffle Accessory Quantities

ACCESSORY PART NO. 30RA-900---	UNIT SIZE 30RAP					
	011, 016	018, 020	025, 030	035, 040	045-060	070-150
054	1	—	—	—	—	—
055	—	1	—	2	—	—
056	—	—	1	—	2	—
005	—	—	—	—	—	1

⚠ CAUTION

To avoid damage to refrigerant coils and electronic components, use extreme care when drilling screw holes and attaching fasteners.

FREEZE PROTECTION — The 30RAP units are provided with a water strainer and a flow switch to protect against freezing situations that occur from no water flow. While the flow switch (thermal dispersion) is helpful in preventing freezing during no-flow situations, it does not protect the chiller in case of power failure, or in other cases where water temperature falls below the freezing mark. Appropriate concentrations of inhibited glycol or other suitable inhibited antifreeze solution should be considered for chiller protection where ambient temperatures are expected to fall below 32°F (0.0°C). Consult local water treatment specialist on characteristics of the system water and add a recommended inhibitor to the chilled water.

⚠ CAUTION

Do not circulate water through unit without strainer in place. Failure to use the strainer represents abuse and may impair or otherwise negatively affect the Carrier product warranty.

1. If the pump will be subjected to freezing temperatures, steps must be taken to prevent freeze damage. If the pump will not be used during this time, it is recommended to drain the pump and hydronic package and back-flush these components with inhibited glycol. Otherwise, a glycol-water solution should be considered as the heat transfer fluid. Units have a drain mounted on the piping leaving the heat exchanger. Drains are located on the sheet metal base of all units.

NOTE: Do not use automobile antifreeze, or any other fluid that is not approved for heat exchanger duty. Use only appropriately inhibited glycols, concentrated to provide adequate protection for the temperature considered.

2. Use an electric tape heater for the internal piping if unit will be exposed to freezing temperature.
3. Ensure that power is available to the chiller at all times, even during the off-season, so that the pump and cooler heaters have power. Also make sure that the piping tape heaters have power.
4. On units with pump packages, a heater is supplied that will protect this section from freezing in outdoor-air temperatures down to -20°F (-29°C), except in case of a power failure.
5. Cooler heaters that will protect down to -20°F (-29°C) can be installed as a factory option. It should be noted that these heaters will not protect the cooler from freezing in the event of a power failure.

PREPARATION FOR WINTER SHUTDOWN — If the unit is not operational during the winter months, at the end of the cooling season complete the following steps.

⚠ CAUTION

Failure to remove power before draining heater-equipped coolers and hydronic packages can result in heater tape and insulation damage.

1. If the cooler/pump will not be drained, do not shut off power during off-season shutdown. If the cooler/pump is drained, open the circuit breaker for the heater or shut off power during off-season shutdown.
2. Drain water from the system.
3. Replace drain plug(s) and add sufficient inhibited glycol (or other suitable inhibited antifreeze) to cooler, pump, and piping to prevent freezing of residual water.
4. At the beginning of the next cooling season, refill cooler and add recommended inhibitor.

Step 5 — Make Electrical Connections

⚠ WARNING

Electrical shock can cause personal injury and death. Shut off all power to this equipment during installation. There may be more than one disconnect switch. Tag all disconnect locations to alert others not to restore power until work is completed.

POWER SUPPLY — Electrical characteristics of available power supply must agree with unit nameplate rating. Field wiring size must be within limits shown in Table 19. See Tables 20-34 for component electrical data.

IMPORTANT: Operating unit on improper supply voltage or with excessive phase imbalance constitutes abuse and may affect Carrier warranty.

POWER WIRING — All power wiring must comply with applicable local and national codes. Install field-supplied branch circuit fused disconnect per NEC (National Electric Code) of a type that can be locked OFF or ON. Disconnect must be within sight from and readily accessible from unit in compliance with NEC Article 440-14.

General Wiring Notes

1. The control circuit does NOT require a separate power source. Control circuit power is obtained by a step-down transformer from the main three-phase power supply. The

LVT (low voltage terminal) strip is provided for field-wired control devices.

2. Cooler and pump heaters (if factory installed) are wired in the control circuit so they are operable as long as the main power supply to the unit and heater safety device is ON. A factory-installed and set overload device protects them.
3. Power is at one end only.
4. All field power enters the unit through a hole located in the corner post of the unit or the bottom of the control box shelf. Refer to Fig. 36 for field wiring details.

Refer to Fig. 9-16 for exact location of field power entry. Be sure to seal entering power wire conduit per NEC requirements.

5. Maximum field wire sizes allowed by lugs on terminal block/non-fused disconnect are listed in Table 19.
6. Terminals for field power supply are suitable for copper conductors. Insulation must be rated 167°F (75°C) minimum.
7. Units with high short circuit ratings and terminal block option require that specific fuses be applied to achieve this rating. Refer to Table 19.

Table 19 — Field Wiring Sizes

CONNECTION TYPE	30RAP UNIT SIZES	MCA RANGE	WIRE SIZE RANGE	MAXIMUM NUMBER OF WIRES PER PHASE	HIGH SCCR FUSE TYPE
TERMINAL BLOCK	011-060	MCA up to 175	14 AWG to 2/0 AWG	1	J, T, RK1, RK5, G, CC
		MCA 175.1 to 335	6 AWG to 400 kcmil	1	J, T, RK1, RK5, G, CC
	070-150	MCA up to 420	2 AWG to 600 kcmil	1	J, T, RK1, RK5, G, CC
		MCA 420.1 to 760	6 AWG to 500 kcmil	2	J, T, RK1, RK5, G, CC
NON-FUSED DISCONNECT	All	MCA up to 100	14 AWG to 3/0 AWG	1	—
	All	MCA 100.1 to 250	6 AWG to 350 kcmil	1	—
	All	MCA 250.1 to 600	3/0 AWG to 500 kcmil	2	—

LEGEND

- AWG** — American Wire Gage
MCA — Minimum Circuit Amps
SCCR — Short Circuit Current Rating

NOTES:

1. Wiring for main field supply must be rated 75 C. Use copper conductors only.
2. Units with high SCCR option and terminal block must use approved fuses to meet high SCCR rating.
3. High SCCR option not available on dual point unit.



Table 20 — 30RAP Electrical Data — Single Point, No Hydronic Package

UNIT 30RAP	UNIT VOLTAGE			POWER SUPPLY QTY REQD.	NO HYDRONIC PACKAGE STANDARD LOW-SOUND AEROACOUSTIC™ FAN				NO HYDRONIC PACKAGE OPTIONAL VALUE SOUND FANS			
	V-Hz (3 Ph)	Supplied			MCA	MOCP	ICF	Rec Fuse Size	MCA	MOCP	ICF	Rec Fuse Size
		Min	Max									
011	208/230-60	187	253	1	51.0	70	186.0	60	51.6	70	186.6	60
	380-60	342	418	1	27.7	35	85.4	35	27.7	35	85.4	35
	380/415-50	342	440	1	24.7	35	85.7	30	25.1	35	86.1	30
	460-60	414	506	1	24.7	35	85.7	30	25.1	35	86.1	30
	575-60	518	633	1	18.0	25	62.1	20	18.2	25	62.3	20
016	208/230-60	187	253	1	64.5	90	269.2	80	65.1	90	269.8	80
	380-60	342	418	1	36.1	50	151.1	40	36.1	50	151.1	40
	380/415-50	342	440	1	32.5	45	144.1	40	32.9	45	144.5	40
	460-60	414	506	1	32.5	45	144.1	40	32.9	45	144.5	40
	575-60	518	633	1	24.4	35	104.0	30	24.6	35	104.2	30
018	208/230-60	187	253	1	87.2	110	270.4	100	88.4	110	271.6	100
	380-60	342	418	1	51.1	70	167.0	60	51.1	70	167.0	60
	380/415-50	342	440	1	43.4	60	136.5	50	44.2	60	137.3	50
	460-60	414	506	1	43.4	60	136.5	50	44.2	60	137.3	50
	575-60	518	633	1	34.9	45	98.2	40	35.3	45	98.6	40
020	208/230-60	187	253	1	92.6	125	286.8	110	93.8	125	288.0	110
	380-60	342	418	1	61.2	80	176.5	70	61.2	80	176.5	70
	380/415-50	342	440	1	46.1	60	148.7	60	46.9	60	149.5	60
	460-60	414	506	1	46.1	60	148.7	60	46.9	60	149.5	60
	575-60	518	633	1	37.0	50	99.1	45	37.4	50	99.5	45
025	208/230-60	187	253	1	127.4	175	363.3	150	128.6	175	364.5	150
	380-60	342	418	1	68.3	90	173.7	80	68.3	90	173.7	80
	380/415-50	342	440	1	57.8	80	178.9	70	58.6	80	179.7	70
	460-60	414	506	1	57.8	80	178.9	70	58.6	80	179.7	70
	575-60	518	633	1	49.6	60	133.7	60	50.0	60	134.1	60
030	208/230-60	187	253	1	137.6	175	407.8	175	138.8	175	409.0	175
	380-60	342	418	1	84.3	110	237.8	100	84.3	110	237.8	100
	380/415-50	342	440	1	66.3	90	211.7	80	67.1	90	212.5	80
	460-60	414	506	1	66.3	90	211.7	80	67.1	90	212.5	80
	575-60	518	633	1	58.1	80	160.5	70	58.5	80	160.9	70
035	208/230-60	187	253	1	165.4	200	359.6	175	167.2	200	361.4	200
	380-60	342	418	1	103.5	125	218.9	110	103.5	125	218.9	110
	380/415-50	342	440	1	82.4	100	185.0	90	83.6	100	186.2	90
	460-60	414	506	1	82.4	100	185.0	90	83.6	100	186.2	90
	575-60	518	633	1	66.1	80	128.2	70	66.7	80	128.8	80
040	208/230-60	187	253	1	197.8	225	395.0	225	199.6	225	396.8	225
	380-60	342	418	1	112.5	125	227.8	125	112.5	125	227.8	125
	380/415-50	342	440	1	86.4	100	188.8	100	87.6	100	190.0	100
	460-60	414	506	1	86.4	100	188.8	100	87.6	100	190.0	100
	575-60	518	633	1	68.9	80	150.9	80	69.5	80	151.5	80
045	208/230-60	187	253	1	229.6	250	468.7	250	231.4	250	470.5	250
	380-60	342	418	1	119.6	125	228.2	125	119.6	125	228.8	125
	380/415-50	342	440	1	97.9	110	223.5	110	99.1	110	224.7	110
	460-60	414	506	1	97.9	110	223.5	110	99.1	110	224.7	110
	575-60	518	633	1	81.4	100	170.7	90	82.0	100	171.3	90
050	208/230-60	187	253	1	236.0	250	471.9	250	237.8	250	473.7	250
	380-60	342	418	1	126.0	150	231.4	150	126.0	150	231.4	150
	380/415-50	342	440	1	106.9	125	228.0	125	108.1	125	229.2	125
	460-60	414	506	1	106.9	125	228.0	125	108.1	125	229.2	125
	575-60	518	633	1	91.8	110	175.9	100	92.4	110	176.5	100
055	208/230-60	187	253	1	252.2	300	526.9	300	254.6	300	529.3	300
	380-60	342	418	1	145.9	175	306.5	175	145.9	175	306.5	175
	380/415-50	342	440	1	118.3	125	267.5	125	119.9	125	269.1	125
	460-60	414	506	1	118.3	125	267.5	125	119.9	125	269.1	125
	575-60	518	633	1	102.7	125	208.9	110	103.5	125	209.7	110
060	208/230-60	187	253	1	261.2	300	531.4	300	263.6	300	533.8	300
	380-60	342	418	1	160.1	175	313.6	175	160.1	175	313.6	175
	380/415-50	342	440	1	125.9	150	271.3	150	127.5	150	272.9	150
	460-60	414	506	1	125.9	150	271.3	150	127.5	150	272.9	150
	575-60	518	633	1	110.3	125	212.7	125	111.1	125	213.5	125

LEGEND

- ICF** — Instantaneous Current Flow
- MCA** — Minimum Circuit Amps
- MOCP** — Maximum Overcurrent Protection

NOTES:

1. Units are suitable for use on electrical systems where voltage supplied to the unit terminals is not below or above the listed minimum and maximum limits. Maximum allowable phase imbalance is: voltage 2%; amps 10%.
2. All units/modules have single point primary power connection. (Each unit/module requires its own power supply.) Main power must be supplied from a field-supplied disconnect.

3. Cooler heater is wired into the control circuit so it is always operable as long as the power supply disconnect and heater safety device are on.
4. 30RAP chillers with Greenspeed® intelligence are not available on unit sizes 070-150.



Table 20 — 30RAP Electrical Data — Single Point, No Hydronic Package (cont)

UNIT 30RAP	UNIT VOLTAGE		POWER SUPPLY QTY REQD.	NO HYDRONIC PACKAGE STANDARD LOW-SOUND AEROACOUSTIC™ FAN				NO HYDRONIC PACKAGE OPTIONAL VALUE SOUND FANS				
	V-Hz (3 Ph)	Supplied		MCA	MOCP	ICF	Rec Fuse Size	MCA	MOCP	ICF	Rec Fuse Size	
		Min										Max
070	208/230-60	187	254	1	323.0	350	593.2	350	326.0	350	596.2	350
	380-60	342	418	1	198.0	225	351.5	225	198.0	225	351.5	225
	380/415-50	342	440	1	155.7	175	301.1	175	157.7	175	303.1	175
	460-60	414	506	1	155.7	175	301.1	175	157.7	175	303.1	175
080	208/230-60	187	254	1	371.3	400	641.5	400	374.9	400	645.1	400
	380-60	342	418	1	214.6	225	368.1	225	214.6	225	368.1	225
	380/415-50	342	440	1	174.1	200	319.5	200	176.5	200	321.9	200
	460-60	414	506	1	174.1	200	319.5	200	176.5	200	321.9	200
090	208/230-60	187	254	1	384.8	400	655.0	400	388.4	400	658.6	400
	380-60	342	418	1	235.9	250	389.4	250	235.9	250	389.4	250
	380/415-50	342	440	1	185.5	200	330.9	200	187.9	200	333.3	200
	460-60	414	506	1	185.5	200	330.9	200	187.9	200	333.3	200
100	208/230-60	187	254	1	459.8	500	902.0	500	464.0	500	906.2	500
	380-60	342	418	1	242.5	250	495.9	250	242.5	250	495.9	250
	380/415-50	342	440	1	203.1	225	411.1	225	205.9	225	413.9	225
	460-60	414	506	1	203.1	225	411.1	225	205.9	225	413.9	225
115	208/230-60	187	254	1	516.8	600	908.0	600	521.6	600	912.8	600
	380-60	342	418	1	271.2	300	483.2	300	271.2	300	483.2	300
	380/415-50	342	440	1	227.6	250	401.7	250	230.8	250	404.9	250
	460-60	414	506	1	227.6	250	401.7	250	230.8	250	404.9	250
130	208/230-60	187	254	1	585.2	600	1027.4	600	590.6	600	1032.8	600
	380-60	342	418	1	310.5	350	563.9	350	310.5	350	563.9	350
	380/415-50	342	440	1	259.4	300	467.4	300	263.0	300	471.0	300
	460-60	414	506	1	259.4	300	467.4	300	263.0	300	471.0	300
150	208/230-60	187	254	1	648.8	700	1091.0	700	654.8	700	1097.0	700
	380-60	342	418	1	347.1	350	600.5	350	347.1	350	600.5	350
	380/415-50	342	440	1	289.0	300	497.0	300	293.0	300	501.0	300
	460-60	414	506	1	289.0	300	497.0	300	293.0	300	501.0	300
	575-60	518	633	1	235.9	250	403.5	250	237.9	250	405.5	250

LEGEND

- ICF** — Instantaneous Current Flow
- MCA** — Minimum Circuit Amps
- MOCP** — Maximum Overcurrent Protection

NOTES:

1. Units are suitable for use on electrical systems where voltage supplied to the unit terminals is not below or above the listed minimum and maximum limits. Maximum allowable phase imbalance is: voltage 2%; amps 10%.
2. All units/modules have single point primary power connection. (Each unit/module requires its own power supply.) Main power must be supplied from a field-supplied disconnect.

3. Cooler heater is wired into the control circuit so it is always operable as long as the power supply disconnect and heater safety device are on.
4. 30RAP chillers with Greenspeed intelligence are not available on unit sizes 070-150.



IEGCSA
AIRE ACONDICIONADO

Table 21 — 30RAP Electrical Data — Dual Point, Low-Sound Aeroacoustic™ Fan, No Hydronic Package

UNIT 30RAP	UNIT VOLTAGE			CIRCUIT 1				CIRCUIT 2			
	V-Ph-Hz	Supplied		MCA	MOCP	ICF	Rec Fuse Size	MCA	MOCP	ICF	Rec Fuse Size
		Min	Max								
070	208/230-3-60	187	254	155.6	200	425.8	175	181.4	225	451.6	200
	380-3-60	342	418	96.0	125	249.5	110	110.5	125	264.0	125
	380/415-3-50	342	440	75.0	100	220.4	90	87.4	110	232.8	100
	460-3-60	414	506	75.0	100	220.4	90	87.4	110	232.8	100
	575-3-60	518	632	65.3	80	167.7	80	77.0	100	179.4	90
080	208/230-3-60	187	254	202.7	250	438.6	225	181.4	225	451.6	200
	380-3-60	342	418	110.8	125	216.2	125	110.5	125	264.0	125
	380/415-3-50	342	440	92.5	110	213.6	100	87.4	110	232.8	100
	460-3-60	414	506	92.5	110	213.6	100	87.4	110	232.8	100
	575-3-60	518	632	79.1	90	163.2	90	77.0	100	179.4	90
090	208/230-3-60	187	254	217.4	250	487.6	250	181.4	225	451.6	200
	380-3-60	342	418	133.9	150	287.4	150	110.5	125	264.0	125
	380/415-3-50	342	440	104.8	125	250.2	125	87.4	110	232.8	100
	460-3-60	414	506	104.8	125	250.2	125	87.4	110	232.8	100
	575-3-60	518	632	91.4	110	193.8	100	77.0	100	179.4	90
100	208/230-3-60	187	254	234.8	300	677.0	300	243.8	300	635.0	300
	380-3-60	342	418	127.3	175	380.7	150	124.8	150	336.8	150
	380/415-3-50	342	440	105.0	150	313.0	125	106.3	125	280.4	125
	460-3-60	414	506	105.0	150	313.0	125	106.3	125	280.4	125
	575-3-60	518	632	85.4	125	253.0	100	85.2	110	227.4	100
115	208/230-3-60	187	254	291.8	350	683.0	350	243.8	300	635.0	300
	380-3-60	342	418	156.0	175	368.0	175	124.8	150	336.8	150
	380/415-3-50	342	440	129.5	150	303.6	150	106.3	125	280.4	125
	460-3-60	414	506	129.5	150	303.6	150	106.3	125	280.4	125
	575-3-60	518	632	104.4	125	246.6	125	85.2	110	227.4	100
130	208/230-3-60	187	254	297.8	350	689.0	350	306.2	400	748.4	350
	380-3-60	342	418	159.9	175	371.9	175	160.2	200	413.6	175
	380/415-3-50	342	440	132.4	150	306.5	150	135.2	175	343.2	150
	460-3-60	414	506	132.4	150	306.5	150	135.2	175	343.2	150
	575-3-60	518	632	106.8	125	249.0	125	110.2	125	277.8	125
150	208/230-3-60	187	254	366.2	450	808.4	400	306.2	400	748.4	350
	380-3-60	342	418	199.2	225	452.6	225	160.2	200	413.6	175
	380/415-3-50	342	440	164.2	200	372.2	175	135.2	175	343.2	150
	460-3-60	414	506	164.2	200	372.2	175	135.2	175	343.2	150
	575-3-60	518	632	134.2	150	301.8	150	110.2	125	277.8	125

LEGEND

- ICF** — Instantaneous Current Flow
- MCA** — Minimum Circuit Amps
- MOCP** — Maximum Overcurrent Protection

NOTES:

1. Units are suitable for use on electrical systems where voltage supplied to the unit terminals is not below or above the listed minimum and maximum limits. Maximum allowable phase imbalance is: voltage 2%; amps 10%.
2. All units/modules have dual point primary power connection. (Each unit/module requires its own power supply.) Main power must be supplied from a field-supplied disconnect.

3. Cooler heater is wired into the control circuit so it is always operable as long as the power supply disconnect and heater safety device are on.
4. 30RAP chillers with Greenspeed® intelligence are not available on unit sizes 070-150.



Table 22 — 30RAP Electrical Data — Dual Point, Optional Value Sound Fan, No Hydronic Package

UNIT 30RAP	UNIT VOLTAGE		CIRCUIT 1					CIRCUIT 2			
	V-Ph-Hz	Supplied		MCA	MOCP	ICF	Rec Fuse Size	MCA	MOCP	ICF	Rec Fuse Size
		Min	Max								
070	208/230-3-60	187	254	158.6	200	428.8	175	181.4	225	451.6	200
	380-3-60	342	418	96.0	125	249.5	110	110.5	125	264.0	125
	380/415-3-50	342	440	77.0	100	222.4	90	87.4	110	232.8	100
	460-3-60	414	506	77.0	100	222.4	90	87.4	110	232.8	100
	575-3-60	518	632	66.3	90	168.7	80	77.0	100	179.4	90
080	208/230-3-60	187	254	206.3	250	442.2	225	181.4	225	451.6	200
	380-3-60	342	418	110.8	125	216.2	125	110.5	125	264.0	125
	380/415-3-50	342	440	94.9	110	216.0	110	87.4	110	232.8	100
	460-3-60	414	506	94.9	110	216.0	110	87.4	110	232.8	100
	575-3-60	518	632	80.3	100	164.4	90	77.0	100	179.4	90
090	208/230-3-60	187	254	221.0	250	491.2	250	181.4	225	451.6	200
	380-3-60	342	418	133.9	150	287.4	150	110.5	125	264.0	125
	380/415-3-50	342	440	107.2	125	252.6	125	87.4	110	232.8	100
	460-3-60	414	506	107.2	125	252.6	125	87.4	110	232.8	100
	575-3-60	518	632	92.6	110	195.0	100	77.0	100	179.4	90
100	208/230-3-60	187	254	239.0	300	681.2	300	243.8	300	635.0	300
	380-3-60	342	418	127.3	175	380.7	150	124.8	150	336.8	150
	380/415-3-50	342	440	107.8	125	315.8	125	106.3	125	280.4	125
	460-3-60	414	506	107.8	125	315.8	125	106.3	125	280.4	125
	575-3-60	518	632	86.8	110	254.4	100	85.2	110	227.4	100
115	208/230-3-60	187	254	296.6	350	687.8	350	243.8	300	635.0	300
	380-3-60	342	418	156.0	175	368.0	175	124.8	150	336.8	150
	380/415-3-50	342	440	132.7	150	306.8	150	106.3	125	280.4	125
	460-3-60	414	506	132.7	150	306.8	150	106.3	125	280.4	125
	575-3-60	518	632	106.0	125	248.2	125	85.2	110	227.4	100
130	208/230-3-60	187	254	303.2	350	694.4	350	306.2	400	748.4	350
	380-3-60	342	418	159.9	175	371.9	175	160.2	200	413.6	175
	380/415-3-50	342	440	136.0	150	310.1	150	135.2	175	343.2	150
	460-3-60	414	506	136.0	150	310.1	150	135.2	175	343.2	150
	575-3-60	518	632	108.6	125	250.8	125	110.2	125	277.8	125
150	208/230-3-60	187	254	372.2	450	814.4	400	306.2	400	748.4	350
	380-3-60	342	418	199.2	225	452.6	225	160.2	200	413.6	175
	380/415-3-50	342	440	168.2	200	376.2	200	135.2	175	343.2	150
	460-3-60	414	506	168.2	200	376.2	200	135.2	175	343.2	150
	575-3-60	518	632	136.2	150	303.8	150	110.2	125	277.8	125

LEGEND

- ICF** — Instantaneous Current Flow
- MCA** — Minimum Circuit Amps
- MOCP** — Maximum Overcurrent Protection

- 3. Cooler heater is wired into the control circuit so it is always operable as long as the power supply disconnect and heater safety device are on.
- 4. 30RAP chillers with Greenspeed® intelligence are not available on unit sizes 070-150.

NOTES:

- 1. Units are suitable for use on electrical systems where voltage supplied to the unit terminals is not below or above the listed minimum and maximum limits. Maximum allowable phase imbalance is: voltage 2%; amps 10%.
- 2. All units/modules have dual point primary power connection. (Each unit/module requires its own power supply.) Main power must be supplied from a field-supplied disconnect.



IEECSA
AIRE ACONDICIONADO

Table 23 — 30RAP Electrical Data — Single Point, Hydronic Package with Standard Low-Sound Aeroacoustic™ Fan (60 Hz Only)

30RAP UNIT SIZE	VOLTAGE V-Hz (3 Ph)	PUMP SIZE 1.5 hp				PUMP SIZE 3.0 hp				PUMP SIZE 5.0 hp			
		MCA	MOCP	ICF	REC FUSE	MCA	MOCP	ICF	REC FUSE	MCA	MOCP	ICF	REC FUSE
011	208/230-60	55.3	70	190.3	70	58.9	80	193.9	70	63.6	80	198.6	70
	380-60	30.1	40	87.8	35	32.1	40	89.8	35	34.7	45	92.4	40
	460-60	26.8	35	87.8	30	28.4	35	89.4	35	30.5	40	91.5	35
	575-60	19.6	25	63.7	25	21.0	25	65.1	25	22.6	30	66.7	25
016	208/230-60	68.8	90	273.5	80	72.4	100	277.1	80	77.1	100	281.8	90
	380-60	38.5	50	153.5	45	40.5	50	155.5	45	43.1	50	158.0	50
	460-60	34.6	45	146.2	40	36.2	50	147.8	40	38.3	50	149.9	45
	575-60	26.0	35	105.6	30	27.4	35	107.0	30	29.0	40	108.6	35
018	208/230-60	91.5	110	274.7	100	95.1	125	278.3	110	99.8	125	283.0	110
	380-60	53.5	70	169.4	60	55.5	70	171.4	70	58.1	70	174.0	70
	460-60	45.5	60	138.6	50	47.1	60	140.2	60	49.2	60	142.3	60
	575-60	36.5	45	99.8	40	37.9	50	101.2	45	39.5	50	102.8	45
020	208/230-60	96.9	125	291.1	110	100.5	125	294.7	110	105.2	125	299.4	125
	380-60	63.6	80	178.9	70	65.6	80	180.9	80	68.2	90	183.5	80
	460-60	48.2	60	150.8	60	49.8	60	152.4	60	51.9	60	154.5	60
	575-60	38.6	50	100.7	45	40.0	50	102.1	45	41.6	50	103.7	50
025	208/230-60	131.7	175	367.6	150	135.3	175	371.2	150	140.0	175	375.9	175
	380-60	70.7	90	176.1	80	72.7	90	178.1	80	75.3	100	180.7	90
	460-60	59.9	80	181.0	70	61.5	80	182.6	70	63.6	80	184.7	70
	575-60	51.2	70	135.3	60	52.6	70	136.7	60	54.2	70	138.3	60
030	208/230-60	141.9	175	412.1	175	145.5	200	415.7	175	150.2	200	420.4	175
	380-60	86.7	110	240.2	100	88.7	110	242.2	100	91.3	125	244.8	100
	460-60	68.4	90	213.8	80	70.0	90	215.4	80	72.1	90	217.5	80
	575-60	59.7	80	162.1	70	61.1	80	163.5	70	62.7	80	165.1	70
035	208/230-60	—	—	—	—	173.3	200	367.5	200	178.0	200	372.2	200
	380-60	—	—	—	—	107.9	125	223.3	125	110.5	125	225.9	125
	460-60	—	—	—	—	86.1	100	188.7	100	88.2	100	190.8	100
	575-60	—	—	—	—	69.1	80	131.2	80	70.7	80	132.8	80
040	208/230-60	—	—	—	—	205.7	250	402.9	225	210.4	250	407.6	225
	380-60	—	—	—	—	116.9	125	232.2	125	119.5	125	234.8	125
	460-60	—	—	—	—	90.1	100	192.5	100	92.2	110	194.6	100
	575-60	—	—	—	—	71.9	80	153.9	80	73.5	80	155.5	80
045	208/230-60	—	—	—	—	237.5	250	476.6	250	242.2	250	481.3	250
	380-60	—	—	—	—	124.0	150	232.6	150	126.6	150	235.2	150
	460-60	—	—	—	—	101.6	110	227.2	110	103.7	125	229.3	110
	575-60	—	—	—	—	84.4	100	173.7	90	86.0	100	175.3	100
050	208/230-60	—	—	—	—	243.9	250	479.8	250	248.6	250	484.5	250
	380-60	—	—	—	—	130.4	150	235.8	150	133.0	150	238.4	150
	460-60	—	—	—	—	110.6	125	231.7	125	112.7	125	233.8	125
	575-60	—	—	—	—	94.8	110	178.9	100	96.4	110	180.5	110
055	208/230-60	—	—	—	—	260.1	300	534.8	300	264.8	300	539.5	300
	380-60	—	—	—	—	150.3	175	310.9	175	152.9	175	313.5	175
	460-60	—	—	—	—	122.0	125	271.2	125	124.1	150	273.3	150
	575-60	—	—	—	—	105.7	125	211.9	125	107.3	125	213.5	125
060	208/230-60	—	—	—	—	269.1	300	539.3	300	273.8	300	544.0	300
	380-60	—	—	—	—	164.5	175	318.0	175	167.1	200	320.6	200
	460-60	—	—	—	—	129.6	150	275.0	150	131.7	150	277.1	150
	575-60	—	—	—	—	113.3	125	215.7	125	114.9	125	217.3	125

LEGEND

- ICF** — Instantaneous Current Flow
- MCA** — Minimum Circuit Amps
- MOCP** — Maximum Overcurrent Protection

NOTES:

1. Units are suitable for use on electrical systems where voltage supplied to the unit terminals is not below or above the listed minimum and maximum limits. Maximum allowable phase imbalance is: voltage 2%; amps 10%.
2. All units/modules have single point primary power connection. (Each unit/module requires its own power supply.) Main power must be supplied from a field-supplied disconnect.

3. Cooler heater is wired into the control circuit so it is always operable as long as the power supply disconnect and heater safety device are on.
4. 30RAP chillers with Greenspeed intelligence are not available on unit sizes 070-150.



LEGESA
AIRE ACONDICIONADO

Table 23 — 30RAP Electrical Data — Single Point, Hydronic Package with Standard Low-Sound Aeroacoustic™ Fan (60 Hz Only) (cont)

30RAP UNIT SIZE	VOLTAGE V-Hz (3 Ph)	PUMP SIZE 7.5 hp				PUMP SIZE 10.0 hp				PUMP SIZE 15.0 hp			
		MCA	MOCP	ICF	REC FUSE	MCA	MOCP	ICF	REC FUSE	MCA	MOCP	ICF	REC FUSE
011	208/230-60	—	—	—	—	—	—	—	—	—	—	—	—
	380-60	—	—	—	—	—	—	—	—	—	—	—	—
	460-60	—	—	—	—	—	—	—	—	—	—	—	—
	575-60	—	—	—	—	—	—	—	—	—	—	—	—
016	208/230-60	—	—	—	—	—	—	—	—	—	—	—	—
	380-60	—	—	—	—	—	—	—	—	—	—	—	—
	460-60	—	—	—	—	—	—	—	—	—	—	—	—
	575-60	—	—	—	—	—	—	—	—	—	—	—	—
018	208/230-60	—	—	—	—	—	—	—	—	—	—	—	—
	380-60	—	—	—	—	—	—	—	—	—	—	—	—
	460-60	—	—	—	—	—	—	—	—	—	—	—	—
	575-60	—	—	—	—	—	—	—	—	—	—	—	—
020	208/230-60	—	—	—	—	—	—	—	—	—	—	—	—
	380-60	—	—	—	—	—	—	—	—	—	—	—	—
	460-60	—	—	—	—	—	—	—	—	—	—	—	—
	575-60	—	—	—	—	—	—	—	—	—	—	—	—
025	208/230-60	—	—	—	—	—	—	—	—	—	—	—	—
	380-60	—	—	—	—	—	—	—	—	—	—	—	—
	460-60	—	—	—	—	—	—	—	—	—	—	—	—
	575-60	—	—	—	—	—	—	—	—	—	—	—	—
030	208/230-60	—	—	—	—	—	—	—	—	—	—	—	—
	380-60	—	—	—	—	—	—	—	—	—	—	—	—
	460-60	—	—	—	—	—	—	—	—	—	—	—	—
	575-60	—	—	—	—	—	—	—	—	—	—	—	—
035	208/230-60	183.9	200	378.1	200	—	—	—	—	—	—	—	—
	380-60	113.9	125	229.3	125	—	—	—	—	—	—	—	—
	460-60	91.1	100	193.7	100	—	—	—	—	—	—	—	—
	575-60	73.1	80	135.2	80	—	—	—	—	—	—	—	—
040	208/230-60	216.3	250	413.5	250	—	—	—	—	—	—	—	—
	380-60	122.9	125	238.2	125	—	—	—	—	—	—	—	—
	460-60	95.1	110	197.5	100	—	—	—	—	—	—	—	—
	575-60	75.9	90	157.9	80	—	—	—	—	—	—	—	—
045	208/230-60	248.1	250	487.2	250	—	—	—	—	—	—	—	—
	380-60	130.0	150	238.6	150	—	—	—	—	—	—	—	—
	460-60	106.6	125	232.2	125	—	—	—	—	—	—	—	—
	575-60	88.4	100	177.7	100	—	—	—	—	—	—	—	—
050	208/230-60	254.5	300	490.4	300	261.0	300	496.9	300	—	—	—	—
	380-60	136.4	150	241.8	150	140.0	150	245.4	150	—	—	—	—
	460-60	115.6	125	236.7	125	118.4	125	239.5	125	—	—	—	—
	575-60	98.8	110	182.9	110	101.0	110	185.1	110	—	—	—	—
055	208/230-60	270.7	300	545.4	300	277.2	300	551.9	300	—	—	—	—
	380-60	156.3	175	316.9	175	159.9	175	320.5	175	—	—	—	—
	460-60	127.0	150	276.2	150	129.8	150	279.0	150	—	—	—	—
	575-60	109.7	125	215.9	125	111.9	125	218.1	125	—	—	—	—
060	208/230-60	279.7	300	549.9	300	286.2	300	556.4	300	—	—	—	—
	380-60	170.5	200	324.0	200	174.1	200	327.6	200	—	—	—	—
	460-60	134.6	150	280.0	150	137.4	150	282.8	150	—	—	—	—
	575-60	117.3	125	219.7	125	119.5	125	221.9	125	—	—	—	—

LEGEND

- ICF** — Instantaneous Current Flow
- MCA** — Minimum Circuit Amps
- MOCP** — Maximum Overcurrent Protection

NOTES:

1. Units are suitable for use on electrical systems where voltage supplied to the unit terminals is not below or above the listed minimum and maximum limits. Maximum allowable phase imbalance is: voltage 2%; amps 10%.
2. All units/modules have single point primary power connection. (Each unit/module requires its own power supply.) Main power must be supplied from a field-supplied disconnect.
3. Cooler heater is wired into the control circuit so it is always operable as long as the power supply disconnect and heater safety device are on.

4. Power draw control circuits include both crankcase heaters (sizes 070-150 only) and cooler heaters (where used). Each compressor on sizes 070-090 has a crankcase heater which draws 90 watts of power, while each compressor on sizes 100-150 has a crankcase heater which draws 56 watts of power.
5. 30RAP chillers with Greenspeed® intelligence are not available on unit sizes 070-150.



LEGSA
AIRE ACONDICIONADO

Table 23 — 30RAP Electrical Data — Single Point, Hydronic Package with Standard Low-Sound Aeroacoustic™ Fan (60 Hz Only) (cont)

30RAP UNIT SIZE	VOLTAGE V-Hz (3 Ph)	PUMP SIZE 1.5 hp				PUMP SIZE 3.0 hp				PUMP SIZE 5.0 hp			
		MCA	MOCP	ICF	REC FUSE	MCA	MOCP	ICF	REC FUSE	MCA	MOCP	ICF	REC FUSE
070	208/230-60	—	—	—	—	—	—	—	—	—	—	—	—
	380-60	—	—	—	—	—	—	—	—	—	—	—	—
	460-60	—	—	—	—	—	—	—	—	—	—	—	—
	575-60	—	—	—	—	—	—	—	—	—	—	—	—
080	208/230-60	—	—	—	—	—	—	—	—	—	—	—	—
	380-60	—	—	—	—	—	—	—	—	—	—	—	—
	460-60	—	—	—	—	—	—	—	—	—	—	—	—
	575-60	—	—	—	—	—	—	—	—	—	—	—	—
090	208/230-60	—	—	—	—	—	—	—	—	—	—	—	—
	380-60	—	—	—	—	—	—	—	—	—	—	—	—
	460-60	—	—	—	—	—	—	—	—	—	—	—	—
	575-60	—	—	—	—	—	—	—	—	—	—	—	—
100	208/230-60	—	—	—	—	—	—	—	—	—	—	—	—
	380-60	—	—	—	—	—	—	—	—	—	—	—	—
	460-60	—	—	—	—	—	—	—	—	—	—	—	—
	575-60	—	—	—	—	—	—	—	—	—	—	—	—
115	208/230-60	—	—	—	—	—	—	—	—	—	—	—	—
	380-60	—	—	—	—	—	—	—	—	—	—	—	—
	460-60	—	—	—	—	—	—	—	—	—	—	—	—
	575-60	—	—	—	—	—	—	—	—	—	—	—	—
130	208/230-60	—	—	—	—	—	—	—	—	—	—	—	—
	380-60	—	—	—	—	—	—	—	—	—	—	—	—
	460-60	—	—	—	—	—	—	—	—	—	—	—	—
	575-60	—	—	—	—	—	—	—	—	—	—	—	—
150	208/230-60	—	—	—	—	—	—	—	—	664.2	700	1106.4	700
	380-60	—	—	—	—	—	—	—	—	355.2	400	608.6	400
	460-60	—	—	—	—	—	—	—	—	296.1	300	504.1	300
	575-60	—	—	—	—	—	—	—	—	241.3	250	408.9	250

30RAP UNIT SIZE	VOLTAGE V-Hz (3 Ph)	PUMP SIZE 7.5 hp				PUMP SIZE 10.0 hp				PUMP SIZE 15.0 hp			
		MCA	MOCP	ICF	REC FUSE	MCA	MOCP	ICF	REC FUSE	MCA	MOCP	ICF	REC FUSE
070	208/230-60	341.5	350	611.7	350	348.0	400	618.2	400	—	—	—	—
	380-60	208.4	225	361.9	225	212.0	225	365.5	225	—	—	—	—
	460-60	164.4	175	309.8	175	167.2	175	312.6	175	—	—	—	—
	575-60	143.4	150	245.8	150	145.6	150	248.0	150	—	—	—	—
080	208/230-60	389.8	400	660.0	400	396.3	450	666.5	450	408.0	450	678.2	450
	380-60	225.0	250	378.5	250	228.6	250	382.1	250	235.6	250	389.1	250
	460-60	182.8	200	328.2	200	185.6	200	331.0	200	191.1	200	336.5	200
	575-60	158.1	175	260.5	175	160.3	175	262.7	175	165.1	175	267.5	175
090	208/230-60	403.3	450	673.5	450	409.8	450	680.0	450	421.5	450	691.7	450
	380-60	246.3	250	399.8	250	249.9	250	403.4	250	256.9	300	410.4	300
	460-60	194.2	200	339.6	200	197.0	200	342.4	200	202.5	225	347.9	225
	575-60	169.5	175	271.9	175	171.7	175	274.1	175	176.5	200	278.9	200
100	208/230-60	478.3	500	920.5	500	484.8	500	927.0	500	496.5	500	938.7	500
	380-60	252.9	300	506.3	300	256.5	300	509.9	300	263.5	300	516.9	300
	460-60	211.8	250	419.8	225	214.6	250	422.0	250	220.1	250	428.1	250
	575-60	171.0	200	338.6	200	173.2	200	340.8	200	178.0	200	345.6	200
115	208/230-60	535.3	600	926.5	600	541.8	600	933.0	600	553.5	600	944.7	600
	380-60	281.6	300	493.6	300	285.2	300	497.2	300	292.2	300	504.2	300
	460-60	236.3	250	410.4	250	239.1	250	413.2	250	244.6	250	418.7	250
	575-60	190.0	200	332.2	200	192.2	200	334.4	200	197.0	200	339.2	200
130	208/230-60	603.7	700	1045.9	700	610.2	700	1052.4	700	621.9	700	1064.1	700
	380-60	320.9	350	574.3	350	324.5	350	577.9	350	331.5	350	584.9	350
	460-60	268.1	300	476.1	300	270.9	300	478.9	300	276.4	300	484.4	300
	575-60	217.4	250	385.0	250	219.6	250	387.2	250	224.4	250	392.0	250
150 Dual Pump	208/230-60	667.3	700	1109.5	700	673.8	700	1116.0	700	685.5	700	1127.7	700
	380-60	357.5	400	610.9	400	361.1	400	614.5	400	368.1	400	621.5	400
	460-60	297.7	300	505.7	300	300.5	350	508.5	350	306.0	350	514.0	350
	575-60	242.9	250	410.5	250	245.1	250	412.7	250	249.9	250	417.5	250

LEGEND

- ICF — Instantaneous Current Flow
- MCA — Minimum Circuit Amps
- MOCP — Maximum Overcurrent Protection

NOTES:

1. Units are suitable for use on electrical systems where voltage supplied to the unit terminals is not below or above the listed minimum and maximum limits. Maximum allowable phase imbalance is: voltage 2%; amps 10%.
2. All units/modules have single point primary power connection. (Each unit/module requires its own power supply.) Main power must be supplied from a field-supplied disconnect.
3. Cooler heater is wired into the control circuit so it is always operable as long as the power supply disconnect and heater safety device are on.
4. Power draw control circuits include both crankcase heaters (sizes 070-150 only) and cooler heaters (where used). Each compressor on sizes

070-090 has a crankcase heater which draws 90 watts of power, while each compressor on sizes 100-150 has a crankcase heater which draws 56 watts of power.

5. 30RAP chillers with Greenspeed® intelligence are not available on unit sizes 070-150.
6. All data is the same for single pump or dual pump except for size 150 with 7.5 hp pump.



Table 24 — 30RAP Electrical Data — Dual Point, Hydronic Package with Standard Low-Sound Aeroacoustic™ Fan (60 Hz Only)

30RAP UNIT SIZE	VOLTAGE V-Ph-Hz	PUMP SIZE 3.0 HP CIRCUIT 1				PUMP SIZE 3.0 HP CIRCUIT 2			
		MCA	MOCP	ICF	REC FUSE	MCA	MOCP	ICF	REC FUSE
150	208/230-3-60	366.2	450	808.4	400	321.6	400	763.8	350
	380-3-60	199.2	225	452.6	225	168.3	200	421.7	200
	460-3-60	164.2	200	372.2	175	142.3	175	350.3	175
	575-3-60	134.2	150	301.8	150	115.6	125	283.2	125

30RAP UNIT SIZE	VOLTAGE V-Ph-Hz	PUMP SIZE 5.0 HP CIRCUIT 1				PUMP SIZE 5.0 HP CIRCUIT 2			
		MCA	MOCP	ICF	REC FUSE	MCA	MOCP	ICF	REC FUSE
070	208/230-3-60	155.6	200	425.8	175	199.9	250	470.1	225
	380-3-60	96.0	125	249.5	110	120.9	150	274.4	150
	460-3-60	75.0	100	220.4	90	96.1	110	241.5	110
	575-3-60	65.3	80	167.7	80	84.0	100	186.4	90
080	208/230-3-60	202.7	250	438.6	225	199.9	250	470.1	225
	380-3-60	110.8	125	216.2	125	120.9	150	274.4	150
	460-3-60	92.5	110	213.6	100	96.1	110	241.5	110
	575-3-60	79.1	90	163.2	90	84.0	100	186.4	90
090	208/230-3-60	217.4	250	487.6	250	199.9	250	470.1	225
	380-3-60	133.9	150	287.4	150	120.9	150	274.4	150
	460-3-60	104.8	125	250.2	125	96.1	110	241.5	110
	575-3-60	91.4	110	193.8	100	84.0	100	186.4	90
100	208/230-3-60	234.8	300	677.0	300	262.3	300	653.5	300
	380-3-60	127.3	175	380.7	150	135.2	150	347.2	150
	460-3-60	105.0	125	313.0	125	115.0	125	289.1	125
	575-3-60	85.4	110	253.0	100	92.2	110	234.4	100
115	208/230-3-60	291.8	350	683.0	350	262.3	300	653.5	300
	380-3-60	156.0	175	368.0	175	135.2	150	347.2	150
	460-3-60	129.5	150	303.6	150	115.0	125	289.1	125
	575-3-60	104.4	125	246.6	125	92.2	110	234.4	100
130	208/230-3-60	297.8	350	689.0	350	324.7	400	766.9	350
	380-3-60	159.9	175	371.9	175	170.6	200	424.0	200
	460-3-60	132.4	150	306.5	150	143.9	175	351.9	175
	575-3-60	106.8	125	249.0	125	117.2	150	284.8	150
150 Dual Pump	208/230-3-60	366.2	450	808.4	400	324.7	400	766.9	350
	380-3-60	199.2	225	452.6	225	170.6	200	424.0	200
	460-3-60	164.2	200	372.2	175	143.9	175	351.9	175
	575-3-60	134.2	150	301.8	150	117.2	150	284.8	150

LEGEND

- ICF** — Instantaneous Current Flow
- MCA** — Minimum Circuit Amps
- MOCP** — Maximum Overcurrent Protection

NOTES:

1. Units are suitable for use on electrical systems where voltage supplied to the unit terminals is not below or above the listed minimum and maximum limits. Maximum allowable phase imbalance is: voltage 2%; amps 10%.
2. All units/modules have single point primary power connection. (Each unit/module requires its own power supply.) Main power must be supplied from a field-supplied disconnect.

3. Cooler heater is wired into the control circuit so it is always operable as long as the power supply disconnect and heater safety device are on.
4. 30RAP chillers with Greenspeed® intelligence are not available on unit sizes 070-150.



Table 24 — 30RAP Electrical Data — Dual Point, Hydronic Package with Standard Low-Sound Aeroacoustic™ Fan (60 Hz Only) (cont)

30RAP UNIT SIZE	VOLTAGE V-Ph-Hz	PUMP SIZE 10.0 HP CIRCUIT 1				PUMP SIZE 10.0 HP CIRCUIT 2			
		MCA	MOCP	ICF	REC FUSE	MCA	MOCP	ICF	REC FUSE
070	208/230-3-60	155.6	200	425.8	175	206.4	250	476.6	225
	380-3-60	96.0	125	249.5	110	124.5	150	278.0	150
	460-3-60	75.0	100	220.4	90	98.9	125	244.3	110
	575-3-60	65.3	80	167.7	80	86.2	100	188.6	100
080	208/230-3-60	202.7	250	438.6	225	206.4	250	476.6	225
	380-3-60	110.8	125	216.2	125	124.5	150	278.0	150
	460-3-60	92.5	110	213.6	100	98.9	125	244.3	110
	575-3-60	79.1	90	163.2	90	86.2	100	188.6	100
090	208/230-3-60	217.4	250	487.6	250	206.4	250	476.6	225
	380-3-60	133.9	150	287.4	150	124.5	150	278.0	150
	460-3-60	104.8	125	250.2	125	98.9	125	244.3	110
	575-3-60	91.4	110	193.8	100	86.2	100	188.6	100
100	208/230-3-60	234.8	300	677.0	300	268.8	300	660.0	300
	380-3-60	127.3	175	380.7	150	138.8	175	350.8	150
	460-3-60	105.0	125	313.0	125	117.8	150	291.9	150
	575-3-60	85.4	110	253.0	100	94.4	110	236.6	110
115	208/230-3-60	291.8	350	683.0	350	268.8	300	660.0	300
	380-3-60	156.0	175	368.0	175	138.8	175	350.8	150
	460-3-60	129.5	150	303.6	150	117.8	150	291.9	150
	575-3-60	104.4	125	246.6	125	94.4	110	236.6	110
130	208/230-3-60	297.8	350	689.0	350	331.2	400	773.4	400
	380-3-60	159.9	175	371.9	175	174.2	225	427.6	200
	460-3-60	132.4	150	306.5	150	146.7	175	354.7	150
	575-3-60	106.8	125	249.0	125	119.4	150	287.0	150
150	208/230-3-60	366.2	450	808.4	400	331.2	400	773.4	400
	380-3-60	199.2	225	452.6	225	174.2	225	427.6	200
	460-3-60	164.2	200	372.2	175	146.7	175	354.7	150
	575-3-60	134.2	150	301.8	150	119.4	150	287.0	150

30RAP UNIT SIZE	VOLTAGE V-Ph-Hz	PUMP SIZE 15.0 HP CIRCUIT 1				PUMP SIZE 15.0 HP CIRCUIT 2			
		MCA	MOCP	ICF	REC FUSE	MCA	MOCP	ICF	REC FUSE
070	208/230-3-60	—	—	—	—	—	—	—	—
	380-3-60	—	—	—	—	—	—	—	—
	460-3-60	—	—	—	—	—	—	—	—
	575-3-60	—	—	—	—	—	—	—	—
080	208/230-3-60	202.7	250	438.6	225	218.1	250	488.3	250
	380-3-60	110.8	125	216.2	125	131.5	150	285.0	150
	460-3-60	92.5	110	213.6	100	104.4	125	249.8	125
	575-3-60	79.1	90	163.2	90	91.0	110	193.4	100
090	208/230-3-60	217.4	250	487.6	250	218.1	250	488.3	250
	380-3-60	133.9	150	287.4	150	131.5	150	285.0	150
	460-3-60	104.8	125	250.2	125	104.4	125	249.8	125
	575-3-60	91.4	110	193.8	100	91.0	110	193.4	100
100	208/230-3-60	234.8	300	677.0	300	280.5	350	671.7	300
	380-3-60	127.3	175	380.7	150	145.8	175	357.8	175
	460-3-60	105.0	125	313.0	125	123.3	150	297.4	150
	575-3-60	85.4	110	253.0	100	99.2	125	241.4	110
115	208/230-3-60	291.8	350	683.0	350	280.5	350	671.7	300
	380-3-60	156.0	175	368.0	175	145.8	175	357.8	175
	460-3-60	129.5	150	303.6	150	123.3	150	297.4	150
	575-3-60	104.4	125	246.6	125	99.2	125	241.4	110
130	208/230-3-60	297.8	350	689.0	350	342.9	400	785.1	400
	380-3-60	159.9	175	371.9	175	181.2	225	434.6	200
	460-3-60	132.4	150	306.5	150	152.2	175	360.2	175
	575-3-60	106.8	125	249.0	125	124.2	150	291.8	150
150	208/230-3-60	366.2	450	808.4	400	342.9	400	785.1	400
	380-3-60	199.2	225	452.6	225	181.2	225	434.6	200
	460-3-60	164.2	200	372.2	175	152.2	175	360.2	175
	575-3-60	134.2	150	301.8	150	124.2	150	291.8	150

LEGEND

- ICF — Instantaneous Current Flow
- MCA — Minimum Circuit Amps
- MOCP — Maximum Overcurrent Protection

- 3. Cooler heater is wired into the control circuit so it is always operable as long as the power supply disconnect and heater safety device are on.
- 4. 30RAP chillers with Greenspeed intelligence are not available on unit sizes 070-150.

NOTES:

1. Units are suitable for use on electrical systems where voltage supplied to the unit terminals is not below or above the listed minimum and maximum limits. Maximum allowable phase imbalance is: voltage 2%; amps 10%.
2. All units/modules have single point primary power connection. (Each unit/module requires its own power supply.) Main power must be supplied from a field-supplied disconnect.



Table 25 — 30RAP Electrical Data — Single Point, Hydronic Package with Optional Value Sound Fans (60 Hz Only)

30RAP UNIT SIZE	VOLTAGE V-Hz (3 Ph)	PUMP SIZE 1.5 HP				PUMP SIZE 3.0 HP				PUMP SIZE 5.0 HP			
		MCA	MOCP	ICF	REC FUSE	MCA	MOCP	ICF	REC FUSE	MCA	MOCP	ICF	REC FUSE
Not Applicable011	208/230-60	55.9	70	190.9	70	59.5	80	194.5	70	64.2	80	199.2	70
	380-60	30.1	40	87.8	35	32.1	40	89.8	35	34.7	45	92.4	40
	460-60	27.2	35	88.2	30	28.8	40	89.8	35	30.9	40	91.9	35
	575-60	19.8	25	63.9	25	21.2	25	65.3	25	22.8	30	66.9	25
016	208/230-60	69.4	90	274.1	80	73.0	100	277.7	90	77.7	100	282.4	90
	380-60	38.5	50	153.5	45	40.5	50	155.5	45	43.1	50	158.1	50
	460-60	35.0	45	146.6	40	36.6	50	148.2	45	38.7	50	150.3	45
	575-60	26.2	35	105.8	30	27.6	35	107.2	35	29.2	40	108.8	35
018	208/230-60	92.7	125	275.9	110	96.3	125	279.5	110	101.0	125	284.2	110
	380-60	53.5	70	169.4	60	55.5	70	171.4	70	58.1	70	174.0	70
	460-60	46.3	60	139.4	60	47.9	60	141.0	60	50.0	60	143.1	60
	575-60	36.9	50	100.2	45	38.3	50	101.6	45	39.9	50	103.2	45
020	208/230-60	98.1	125	292.3	110	101.7	125	295.9	125	106.4	125	300.6	125
	380-60	63.6	80	178.9	70	65.6	80	180.9	80	68.2	90	183.5	80
	460-60	49.0	60	151.6	60	50.6	60	153.2	60	52.7	70	155.3	60
	575-60	39.0	50	101.1	45	40.4	50	102.5	45	42.0	50	104.1	50
025	208/230-60	132.9	175	368.8	150	136.5	175	372.4	150	141.2	175	377.1	175
	380-60	70.7	90	176.1	80	72.7	90	178.1	80	75.3	100	180.7	90
	460-60	60.7	80	181.8	70	62.3	80	183.4	70	64.4	80	185.5	80
	575-60	51.6	70	135.7	60	53.0	70	137.1	60	54.6	70	138.7	60
030	208/230-60	143.1	175	413.3	175	146.7	200	416.9	175	151.4	200	421.6	175
	380-60	86.7	110	240.2	100	88.7	110	242.2	100	91.3	125	244.8	100
	460-60	69.2	90	214.6	80	70.8	90	216.2	80	72.9	90	218.3	80
	575-60	60.1	80	162.5	70	61.5	80	163.9	70	63.1	80	165.5	70
035	208/230-60	—	—	—	—	175.1	200	369.3	200	179.8	200	374.0	200
	380-60	—	—	—	—	107.9	125	223.2	125	110.5	125	225.9	125
	460-60	—	—	—	—	87.3	100	189.9	100	89.4	100	192.0	100
	575-60	—	—	—	—	69.7	80	131.8	80	71.3	80	133.4	80
040	208/230-60	—	—	—	—	207.5	250	404.7	225	212.2	250	409.4	225
	380-60	—	—	—	—	116.9	125	232.2	125	119.5	125	234.8	125
	460-60	—	—	—	—	91.3	100	193.7	100	93.4	110	195.8	100
	575-60	—	—	—	—	72.5	80	154.5	80	74.1	80	156.1	80
045	208/230-60	—	—	—	—	239.3	250	478.4	250	244.0	250	483.1	250
	380-60	—	—	—	—	124.0	150	232.6	150	126.6	150	235.2	150
	460-60	—	—	—	—	102.8	125	228.4	110	104.9	125	230.5	125
	575-60	—	—	—	—	85.0	100	174.3	90	86.6	100	175.9	100
050	208/230-60	—	—	—	—	245.7	250	481.6	250	250.4	300	486.3	300
	380-60	—	—	—	—	130.4	150	235.8	150	133.0	150	238.4	150
	460-60	—	—	—	—	111.8	125	232.9	125	113.9	125	235.0	125
	575-60	—	—	—	—	95.4	110	179.5	110	97.0	110	181.1	110
055	208/230-60	—	—	—	—	262.5	300	537.2	300	267.2	300	541.9	300
	380-60	—	—	—	—	150.3	175	310.9	175	152.9	175	313.5	175
	460-60	—	—	—	—	123.6	150	272.8	150	125.7	150	274.9	150
	575-60	—	—	—	—	106.5	125	212.7	125	108.1	125	214.3	125
060	208/230-60	—	—	—	—	271.5	300	541.7	300	276.2	300	546.4	300
	380-60	—	—	—	—	164.5	175	318.0	175	167.1	200	320.6	200
	460-60	—	—	—	—	131.2	150	276.6	150	133.3	150	278.7	150
	575-60	—	—	—	—	114.1	125	216.5	125	115.7	125	218.1	125

LEGEND

- ICF — Instantaneous Current Flow
- MCA — Minimum Circuit Amps
- MOCP — Maximum Overcurrent Protection

NOTES:

1. Units are suitable for use on electrical systems where voltage supplied to the unit terminals is not below or above the listed minimum and maximum limits. Maximum allowable phase imbalance is: voltage 2%; amps 10%.
2. All units/modules have single point primary power connection. (Each unit/module requires its own power supply.) Main power must be supplied from a field-supplied disconnect.

3. Cooler heater is wired into the control circuit so it is always operable as long as the power supply disconnect and heater safety device are on.
4. 30RAP chillers with Greenspeed® intelligence are not available on unit sizes 070-150.



Intertek



Table 25 — 30RAP Electrical Data — Single Point, Hydronic Package with Optional Value Sound Fans (60 Hz Only) (cont)

30RAP UNIT SIZE	VOLTAGE V-Hz (3 Ph)	PUMP SIZE 7.5 HP				PUMP SIZE 10.0 HP				PUMP SIZE 15.0 HP			
		MCA	MOCP	ICF	REC FUSE	MCA	MOCP	ICF	REC FUSE	MCA	MOCP	ICF	REC FUSE
011	208/230-60	—	—	—	—	—	—	—	—	—	—	—	—
	380-60	—	—	—	—	—	—	—	—	—	—	—	—
	460-60	—	—	—	—	—	—	—	—	—	—	—	—
	575-60	—	—	—	—	—	—	—	—	—	—	—	—
016	208/230-60	—	—	—	—	—	—	—	—	—	—	—	—
	380-60	—	—	—	—	—	—	—	—	—	—	—	—
	460-60	—	—	—	—	—	—	—	—	—	—	—	—
	575-60	—	—	—	—	—	—	—	—	—	—	—	—
018	208/230-60	—	—	—	—	—	—	—	—	—	—	—	—
	380-60	—	—	—	—	—	—	—	—	—	—	—	—
	460-60	—	—	—	—	—	—	—	—	—	—	—	—
	575-60	—	—	—	—	—	—	—	—	—	—	—	—
020	208/230-60	—	—	—	—	—	—	—	—	—	—	—	—
	380-60	—	—	—	—	—	—	—	—	—	—	—	—
	460-60	—	—	—	—	—	—	—	—	—	—	—	—
	575-60	—	—	—	—	—	—	—	—	—	—	—	—
025	208/230-60	—	—	—	—	—	—	—	—	—	—	—	—
	380-60	—	—	—	—	—	—	—	—	—	—	—	—
	460-60	—	—	—	—	—	—	—	—	—	—	—	—
	575-60	—	—	—	—	—	—	—	—	—	—	—	—
030	208/230-60	—	—	—	—	—	—	—	—	—	—	—	—
	380-60	—	—	—	—	—	—	—	—	—	—	—	—
	460-60	—	—	—	—	—	—	—	—	—	—	—	—
	575-60	—	—	—	—	—	—	—	—	—	—	—	—
035	208/230-60	185.7	200	379.9	200	—	—	—	—	—	—	—	—
	380-60	113.9	125	229.3	125	—	—	—	—	—	—	—	—
	460-60	92.3	110	194.9	100	—	—	—	—	—	—	—	—
	575-60	73.7	80	135.8	80	—	—	—	—	—	—	—	—
040	208/230-60	218.1	250	415.3	250	—	—	—	—	—	—	—	—
	380-60	122.9	125	238.2	125	—	—	—	—	—	—	—	—
	460-60	96.3	110	198.7	110	—	—	—	—	—	—	—	—
	575-60	76.5	90	158.5	90	—	—	—	—	—	—	—	—
045	208/230-60	249.9	300	489.0	300	—	—	—	—	—	—	—	—
	380-60	130.0	150	238.6	150	—	—	—	—	—	—	—	—
	460-60	107.8	125	233.4	125	—	—	—	—	—	—	—	—
	575-60	89.0	100	178.3	100	—	—	—	—	—	—	—	—
050	208/230-60	256.3	300	492.2	300	262.8	300	498.7	300	—	—	—	—
	380-60	136.4	150	241.8	150	140.0	150	245.4	150	—	—	—	—
	460-60	116.8	125	237.9	125	119.6	125	240.7	125	—	—	—	—
	575-60	99.4	110	183.5	110	101.6	110	185.7	110	—	—	—	—
055	208/230-60	273.1	300	547.8	300	279.6	300	554.3	300	—	—	—	—
	380-60	156.3	175	316.9	175	159.9	175	320.5	175	—	—	—	—
	460-60	128.6	150	277.8	150	131.4	150	280.6	150	—	—	—	—
	575-60	110.5	125	216.7	125	112.7	125	218.9	125	—	—	—	—
060	208/230-60	282.1	300	552.3	300	288.6	300	558.8	300	—	—	—	—
	380-60	170.5	200	324.0	200	174.1	200	327.6	200	—	—	—	—
	460-60	136.2	150	281.6	150	139.0	150	284.4	150	—	—	—	—
	575-60	118.1	125	220.5	125	120.3	125	222.7	125	—	—	—	—

LEGEND

- ICF** — Instantaneous Current Flow
- MCA** — Minimum Circuit Amps
- MOCP** — Maximum Overcurrent Protection

- 3. Cooler heater is wired into the control circuit so it is always operable as long as the power supply disconnect and heater safety device are on.
- 4. 30RAP chillers with Greenspeed intelligence are not available on unit sizes 070-150.

NOTES:

1. Units are suitable for use on electrical systems where voltage supplied to the unit terminals is not below or above the listed minimum and maximum limits. Maximum allowable phase imbalance is: voltage 2%; amps 10%.
2. All units/modules have single point primary power connection. (Each unit/module requires its own power supply.) Main power must be supplied from a field-supplied disconnect.



Table 25 — 30RAP Electrical Data — Single Point, Hydronic Package with Optional Value Sound Fans (60 Hz Only) (cont)

30RAP UNIT SIZE	VOLTAGE V-Hz (3 Ph)	PUMP SIZE 1.5 hp				PUMP SIZE 3.0 hp				PUMP SIZE 5.0 hp			
		MCA	MOCP	ICF	REC FUSE	MCA	MOCP	ICF	REC FUSE	MCA	MOCP	ICF	REC FUSE
070	208/230-60	—	—	—	—	—	—	—	—	—	—	—	—
	380-60	—	—	—	—	—	—	—	—	—	—	—	—
	460-60	—	—	—	—	—	—	—	—	—	—	—	—
	575-60	—	—	—	—	—	—	—	—	—	—	—	—
080	208/230-60	—	—	—	—	—	—	—	—	—	—	—	—
	380-60	—	—	—	—	—	—	—	—	—	—	—	—
	460-60	—	—	—	—	—	—	—	—	—	—	—	—
	575-60	—	—	—	—	—	—	—	—	—	—	—	—
090	208/230-60	—	—	—	—	—	—	—	—	—	—	—	—
	380-60	—	—	—	—	—	—	—	—	—	—	—	—
	460-60	—	—	—	—	—	—	—	—	—	—	—	—
	575-60	—	—	—	—	—	—	—	—	—	—	—	—
100	208/230-60	—	—	—	—	—	—	—	—	—	—	—	—
	380-60	—	—	—	—	—	—	—	—	—	—	—	—
	460-60	—	—	—	—	—	—	—	—	—	—	—	—
	575-60	—	—	—	—	—	—	—	—	—	—	—	—
115	208/230-60	—	—	—	—	—	—	—	—	—	—	—	—
	380-60	—	—	—	—	—	—	—	—	—	—	—	—
	460-60	—	—	—	—	—	—	—	—	—	—	—	—
	575-60	—	—	—	—	—	—	—	—	—	—	—	—
130	208/230-60	—	—	—	—	—	—	—	—	—	—	—	—
	380-60	—	—	—	—	—	—	—	—	—	—	—	—
	460-60	—	—	—	—	—	—	—	—	—	—	—	—
	575-60	—	—	—	—	—	—	—	—	—	—	—	—
150	208/230-60	—	—	—	—	—	—	—	—	670.2	700	1112.4	700
	380-60	—	—	—	—	—	—	—	—	355.2	400	608.6	400
	460-60	—	—	—	—	—	—	—	—	300.1	350	508.1	350
	575-60	—	—	—	—	—	—	—	—	243.3	250	410.9	250

30RAP UNIT SIZE	VOLTAGE V-Hz (3 Ph)	PUMP SIZE 7.5 hp				PUMP SIZE 10.0 hp				PUMP SIZE 15.0 hp			
		MCA	MOCP	ICF	REC FUSE	MCA	MOCP	ICF	REC FUSE	MCA	MOCP	ICF	REC FUSE
070	208/230-60	344.5	400	614.7	400	351.0	400	621.2	400	—	—	—	—
	380-60	208.4	225	361.9	225	212.0	225	365.5	225	—	—	—	—
	460-60	166.4	175	311.8	175	169.2	175	314.6	175	—	—	—	—
	575-60	144.4	150	246.8	150	146.6	150	249.0	150	—	—	—	—
080	208/230-60	393.4	400	663.6	400	399.9	450	670.1	450	411.6	450	681.8	450
	380-60	225.0	250	378.5	250	228.6	250	382.1	250	235.6	250	389.1	250
	460-60	185.2	200	330.6	200	188.0	200	333.4	200	193.5	200	338.9	200
	575-60	159.3	175	261.7	175	161.5	175	263.9	175	166.3	175	268.7	175
090	208/230-60	406.9	450	677.1	450	413.4	450	683.6	450	425.1	450	695.3	450
	380-60	246.3	250	399.8	250	249.9	250	403.4	250	256.9	300	410.4	300
	460-60	196.6	200	342.0	200	199.4	225	344.8	225	204.9	225	350.3	225
	575-60	170.7	175	273.1	175	172.9	175	275.3	175	177.7	200	280.1	200
100	208/230-60	482.5	500	924.7	500	489.0	500	931.2	500	500.7	600	942.9	600
	380-60	252.9	300	506.3	300	256.5	300	509.9	300	263.5	300	516.9	300
	460-60	214.6	250	422.6	250	217.4	250	425.4	250	222.9	250	430.9	250
	575-60	172.4	200	340.0	200	174.6	200	342.2	200	179.4	200	347.0	200
115	208/230-60	540.1	600	931.3	600	546.6	600	937.8	600	558.3	600	949.5	600
	380-60	281.6	300	493.6	300	285.2	300	497.2	300	292.2	300	504.2	300
	460-60	239.5	250	413.6	250	242.3	250	416.4	250	247.8	250	421.9	250
	575-60	191.6	200	333.8	200	193.8	200	336.0	200	198.6	200	340.8	200
130	208/230-60	609.1	700	1051.3	700	615.6	700	1057.8	700	627.3	700	1069.5	700
	380-60	320.9	350	574.3	350	324.5	350	577.9	350	331.5	350	584.9	350
	460-60	271.7	300	479.7	300	274.5	300	482.5	300	280.0	300	488.0	300
	575-60	219.2	250	386.8	250	221.4	250	389.0	250	226.2	250	393.8	250
150 Dual Pump	208/230-60	673.3	700	1115.5	700	679.8	700	1122.0	700	691.5	700	1133.7	700
	380-60	357.5	400	610.9	400	361.1	400	614.5	400	368.1	400	621.5	400
	460-60	301.7	350	509.7	350	304.5	350	512.5	350	310.0	350	518.0	350
	575-60	244.9	250	412.5	250	247.1	250	414.7	250	251.9	300	419.5	300
150 Single Pump	208/230-60	676.8	700	1119.0	700	679.8	700	1122.0	700	691.5	700	1133.7	700
	380-60	359.4	400	612.8	400	361.1	400	614.5	400	368.1	400	621.5	400
	460-60	303.1	300	511.1	350	304.5	350	512.5	350	310.0	350	518.0	350
	575-60	246.0	250	413.6	250	247.1	250	414.7	250	251.9	300	419.5	300

LEGEND

- ICF — Instantaneous Current Flow
- MCA — Minimum Circuit Amps
- MOCP — Maximum Overcurrent Protection

NOTES:

1. Units are suitable for use on electrical systems where voltage supplied to the unit terminals is not below or above the listed minimum and maximum limits. Maximum allowable phase imbalance is: voltage 2%; amps 10%.
2. All units/modules have single point primary power connection. (Each unit/module requires its own power supply.) Main power must be supplied from a field-supplied disconnect.

3. Cooler heater is wired into the control circuit so it is always operable as long as the power supply disconnect and heater safety device are on.
4. 30RAP chillers with Greenspeed intelligence are not available on unit sizes 070-150.



Table 26 — 30RAP Electrical Data — Dual Point, Hydronic Package with Optional Value Sound Fans (60 Hz Only)

30RAP UNIT SIZE	VOLTAGE V-Ph-Hz	PUMP SIZE 5.0 hp, CIRCUIT 1				PUMP SIZE 5.0 hp, CIRCUIT 2			
		MCA	MOCP	ICF	REC FUSE	MCA	MOCP	ICF	REC FUSE
150	208/230-3-60	372.2	450	814.4	400	321.6	400	763.8	350
	380-3-60	199.2	225	452.6	225	168.3	200	421.7	200
	460-3-60	168.2	200	376.2	200	142.3	175	350.3	175
	575-3-60	136.2	150	303.8	150	115.6	125	283.2	125
30RAP UNIT SIZE	VOLTAGE V-Ph-Hz	PUMP SIZE 7.5 hp, CIRCUIT 1				PUMP SIZE 7.5 hp, CIRCUIT 2			
		MCA	MOCP	ICF	REC FUSE	MCA	MOCP	ICF	REC FUSE
070	208/230-3-60	158.6	200	428.8	175	199.9	250	470.1	225
	380-3-60	96.0	125	249.5	110	120.9	150	274.4	150
	460-3-60	77.0	100	222.4	90	96.1	110	241.5	110
	575-3-60	66.3	90	168.7	80	84.0	100	186.4	90
080	208/230-3-60	206.3	250	442.2	225	199.9	250	470.1	225
	380-3-60	110.8	125	216.2	125	120.9	150	274.4	150
	460-3-60	94.9	110	216.0	110	96.1	110	241.5	110
	575-3-60	80.3	100	164.4	90	84.0	100	186.4	90
090	208/230-3-60	221.0	250	491.2	250	199.9	250	470.1	225
	380-3-60	133.9	150	287.4	150	120.9	150	274.4	150
	460-3-60	107.2	125	252.6	125	96.1	110	241.5	110
	575-3-60	92.6	110	195.0	100	84.0	100	186.4	90
100	208/230-3-60	239.0	300	681.2	300	262.3	300	653.5	300
	380-3-60	127.3	175	380.7	150	135.2	150	347.2	150
	460-3-60	107.8	125	315.8	125	115.0	125	289.1	125
	575-3-60	86.8	110	254.4	100	92.2	110	234.4	100
115	208/230-3-60	296.6	350	687.8	350	262.3	300	653.5	300
	380-3-60	156.0	175	368.0	175	135.2	150	347.2	150
	460-3-60	132.7	150	306.8	150	115.0	125	289.1	125
	575-3-60	106.0	125	248.2	125	92.2	110	234.4	100
130	208/230-3-60	303.2	350	694.4	350	324.7	400	766.9	350
	380-3-60	159.9	175	371.9	175	170.6	200	424.0	200
	460-3-60	136.0	150	310.1	150	143.9	175	351.9	175
	575-3-60	108.6	125	250.8	125	117.2	150	284.8	150
150 Dual Pump	208/230-3-60	372.2	450	814.4	400	324.7	400	766.9	350
	380-3-60	199.2	225	452.6	225	170.6	200	424.0	200
	460-3-60	168.2	200	376.2	200	143.9	175	351.9	175
	575-3-60	136.2	150	303.8	150	117.2	150	284.8	150
150 Single Pump	208/230-3-60	372.2	450	814.4	400	328.2	400	770.4	400
	380-3-60	199.2	225	452.6	225	172.5	200	425.9	200
	460-3-60	168.2	200	376.2	200	145.3	175	353.3	175
	575-3-60	136.2	150	303.8	150	118.3	150	285.9	150

LEGEND

- ICF** — Instantaneous Current Flow
- MCA** — Minimum Circuit Amps
- MOCP** — Maximum Overcurrent Protection

NOTES:

1. Units are suitable for use on electrical systems where voltage supplied to the unit terminals is not below or above the listed minimum and maximum limits. Maximum allowable phase imbalance is: voltage 2%; amps 10%.
2. All units/modules have dual point primary power connection. (Each unit/module requires its own power supply.) Main power must be supplied from a field-supplied disconnect.

3. Cooler heater is wired into the control circuit so it is always operable as long as the power supply disconnect is on, even if any safety device is open.
4. 30RAP chillers with Greenspeed® intelligence are not available on unit sizes 070-150.



BECSA
AIRE ACONDICIONADO

Table 26 — 30RAP Electrical Data — Dual Point, Hydronic Package with Optional Value Sound Fans (60 Hz Only) (cont)

30RAP UNIT SIZE	VOLTAGE V-Ph-Hz	PUMP SIZE 10.0 HP CIRCUIT 1				PUMP SIZE 10.0 HP CIRCUIT 2			
		MCA	MOCP	ICF	REC FUSE	MCA	MOCP	ICF	REC FUSE
070	208/230-3-60	158.6	200	428.8	175	206.4	250	476.6	225
	380-3-60	96.0	125	249.5	110	124.5	150	278.0	150
	460-3-60	77.0	100	222.4	90	98.9	125	244.3	110
	575-3-60	66.3	90	168.7	80	86.2	100	188.6	100
080	208/230-3-60	206.3	250	442.2	225	206.4	250	476.6	225
	380-3-60	110.8	125	216.2	125	124.5	150	278.0	150
	460-3-60	94.9	110	216.0	110	98.9	125	244.3	110
	575-3-60	80.3	100	164.4	90	86.2	100	188.6	100
090	208/230-3-60	221.0	250	491.2	250	206.4	250	476.6	225
	380-3-60	133.9	150	287.4	150	124.5	150	278.0	150
	460-3-60	107.2	125	252.6	125	98.9	125	244.3	110
	575-3-60	92.6	110	195.0	100	86.2	100	188.6	100
100	208/230-3-60	239.0	300	681.2	300	268.8	300	660.0	300
	380-3-60	127.3	175	380.7	150	138.8	175	350.8	150
	460-3-60	107.8	125	315.8	125	117.8	150	291.9	150
	575-3-60	86.8	110	254.4	100	94.4	110	236.6	110
115	208/230-3-60	296.6	350	687.8	350	268.8	300	660.0	300
	380-3-60	156.0	175	368.0	175	138.8	175	350.8	150
	460-3-60	132.7	150	306.8	150	117.8	150	291.9	150
	575-3-60	106.0	125	248.2	125	94.4	110	236.6	110
130	208/230-3-60	303.2	350	694.4	350	331.2	400	773.4	400
	380-3-60	159.9	175	371.9	175	174.2	225	427.6	200
	460-3-60	136.0	150	310.1	150	146.7	175	354.7	175
	575-3-60	108.6	125	250.8	125	119.4	150	287.0	150
150	208/230-3-60	372.2	450	814.4	400	331.2	400	773.4	400
	380-3-60	199.2	225	452.6	225	174.2	225	427.6	200
	460-3-60	168.2	200	376.2	200	146.7	175	354.7	175
	575-3-60	136.2	150	303.8	150	119.4	150	287.0	150

30RAP UNIT SIZE	VOLTAGE V-Ph-Hz	PUMP SIZE 15.0 HP CIRCUIT 1				PUMP SIZE 15.0 HP CIRCUIT 2			
		MCA	MOCP	ICF	REC FUSE	MCA	MOCP	ICF	REC FUSE
070	208/230-3-60	—	—	—	—	—	—	—	—
	380-3-60	—	—	—	—	—	—	—	—
	460-3-60	—	—	—	—	—	—	—	—
	575-3-60	—	—	—	—	—	—	—	—
080	208/230-3-60	206.3	250	442.2	225	218.1	250	488.3	250
	380-3-60	110.8	125	216.2	125	131.5	150	285.0	150
	460-3-60	94.9	110	216.0	110	104.4	125	249.8	125
	575-3-60	80.3	100	164.4	90	91.0	110	193.4	100
090	208/230-3-60	221.0	250	491.2	250	218.1	250	488.3	250
	380-3-60	133.9	150	287.4	150	131.5	150	285.0	150
	460-3-60	107.2	125	252.6	125	104.4	125	249.8	125
	575-3-60	92.6	110	195.0	100	91.0	110	193.4	100
100	208/230-3-60	239.0	300	681.2	300	280.5	350	671.7	300
	380-3-60	127.3	175	380.7	150	145.8	175	357.8	175
	460-3-60	107.8	125	315.8	125	123.3	150	297.4	150
	575-3-60	86.8	110	254.4	100	99.2	125	241.4	110
115	208/230-3-60	296.6	350	687.8	350	280.5	350	671.7	300
	380-3-60	156.0	175	368.0	175	145.8	175	357.8	175
	460-3-60	132.7	150	306.8	150	123.3	150	297.4	150
	575-3-60	106.0	125	248.2	125	99.2	125	241.4	110
130	208/230-3-60	303.2	350	694.4	350	342.9	400	785.1	400
	380-3-60	159.9	175	371.9	175	181.2	225	434.6	200
	460-3-60	136.0	150	310.1	150	152.2	175	360.2	175
	575-3-60	108.6	125	250.8	125	124.2	150	291.8	150
150	208/230-3-60	372.2	450	814.4	400	342.9	400	785.1	400
	380-3-60	199.2	225	452.6	225	181.2	225	434.6	200
	460-3-60	168.2	200	376.2	200	152.2	175	360.2	175
	575-3-60	136.2	150	303.8	150	124.2	150	291.8	150

LEGEND

- ICF** — Instantaneous Current Flow
- MCA** — Minimum Circuit Amps
- MOCP** — Maximum Overcurrent Protection

- 3. Cooler heater is wired into the control circuit so it is always operable as long as the power supply disconnect is on, even if any safety device is open.
- 4. 30RAP chillers with Greenspeed® intelligence are not available on unit sizes 070-150.

NOTES:

- 1. Units are suitable for use on electrical systems where voltage supplied to the unit terminals is not below or above the listed minimum and maximum limits. Maximum allowable phase imbalance is: voltage 2%; amps 10%.
- 2. All units/modules have dual point primary power connection. (Each unit/module requires its own power supply.) Main power must be supplied from a field-supplied disconnect.



Table 27 — Fan Electrical Data — Single Point, Standard Low-Sound Aeroacoustic™ Fans Unit Sizes 011-060

UNIT 30RAP	UNIT VOLTAGE V-Hz (3 Ph)	STANDARD CONDENSER FANS	
		Quantity	FLA (each)
011	208/230-60	1	6.0
	380-60	1	3.9
	380/415-50	1	2.9
	460-60	1	2.9
	575-60	1	2.4
016	208/230-60	1	6.0
	380-60	1	3.9
	380/415-50	1	2.9
	460-60	1	2.9
	575-60	1	2.4
018	208/230-60	2	6.0
	380-60	2	3.9
	380/415-50	2	2.9
	460-60	2	2.9
	575-60	2	2.4
020	208/230-60	2	6.0
	380-60	2	3.9
	380/415-50	2	2.9
	460-60	2	2.9
	575-60	2	2.4
025	208/230-60	2	6.0
	380-60	2	3.9
	380/415-50	2	2.9
	460-60	2	2.9
	575-60	2	2.4
030	208/230-60	2	6.0
	380-60	2	3.9
	380/415-50	2	2.9
	460-60	2	2.9
	575-60	2	2.4
035	208/230-60	3	6.0
	380-60	3	3.9
	380/415-50	3	2.9
	460-60	3	2.9
	575-60	3	2.4
040	208/230-60	3	6.0
	380-60	3	3.9
	380/415-50	3	2.9
	460-60	3	2.9
	575-60	3	2.4
045	208/230-60	3	6.0
	380-60	3	3.9
	380/415-50	3	2.9
	460-60	3	2.9
	575-60	3	2.4
050	208/230-60	3	6.0
	380-60	3	3.9
	380/415-50	3	2.9
	460-60	3	2.9
	575-60	3	2.4
055	208/230-60	4	6.0
	380-60	4	3.9
	380/415-50	4	2.9
	460-60	4	2.9
	575-60	4	2.4
060	208/230-60	4	6.0
	380-60	4	3.9
	380/415-50	4	2.9
	460-60	4	2.9
	575-60	4	2.4

LEGEND

FLA — Full Load Amps

NOTES:

1. Units are suitable for use on electrical systems where voltage supplied to the unit terminals is not below or above the listed minimum and maximum limits. Maximum allowable phase imbalance is: voltage 2%; amps 10%.
2. All units/modules have single point primary power connection. (Each unit/module requires its own power supply.) Main power must be supplied from a field-supplied disconnect.
3. The unit control circuit power transformer (24 v, single-phase for all voltages) is factory supplied.
4. Cooler heater is wired into the control circuit so it is always operable as long as the power supply disconnect and heater safety device are on.
5. 30RAP chillers with Greenspeed intelligence are not available on unit sizes 070-150.

Table 28 — Fan Electrical Data — Single Point, Standard Low-Sound Aeroacoustic™ Fans Unit Sizes 070-150

UNIT 30RAP	UNIT VOLTAGE V-Hz (3 Ph)	STANDARD CONDENSER FANS	
		Quantity	FLA (each)
070	208/230-60	5	6.0
	380-60	5	3.9
	380/415-50	5	2.9
	460-60	5	2.9
	575-60	5	2.4
080	208/230-60	6	6.0
	380-60	6	3.9
	380/415-50	6	2.9
	460-60	6	2.9
	575-60	6	2.4
090	208/230-60	6	6.0
	380-60	6	3.9
	380/415-50	6	2.9
	460-60	6	2.9
	575-60	6	2.4
100	208/230-60	7	6.0
	380-60	7	3.9
	380/415-50	7	2.9
	460-60	7	2.9
	575-60	7	2.4
115	208/230-60	8	6.0
	380-60	8	3.9
	380/415-50	8	2.9
	460-60	8	2.9
	575-60	8	2.4
130	208/230-60	9	6.0
	380-60	9	3.9
	380/415-50	9	2.9
	460-60	9	2.9
	575-60	9	2.4
150	208/230-60	10	6.0
	380-60	10	3.9
	380/415-50	10	2.9
	460-60	10	2.9
	575-60	10	2.4

LEGEND

FLA — Full Load Amps

NOTES:

1. Units are suitable for use on electrical systems where voltage supplied to the unit terminals is not below or above the listed minimum and maximum limits. Maximum allowable phase imbalance is: voltage 2%; amps 10%.
2. All units/modules have single point primary power connection. (Each unit/module requires its own power supply.) Main power must be supplied from a field-supplied disconnect.
3. The unit control circuit power transformer (24 v, single-phase for all voltages) is factory supplied.
4. Cooler heater is wired into the control circuit so it is always operable as long as the power supply disconnect and heater safety device are on.
5. 30RAP chillers with Greenspeed® intelligence are not available on unit sizes 070-150.

**Table 29 — Fan Electrical Data — Single Point, Optional Value Sound Fans
Unit Sizes 011-060**

UNIT 30RAP	UNIT VOLTAGE V-Hz (3 Ph)	OPTIONAL CONDENSER FANS	
		Quantity	FLA (each)
011	208/230-60	1	6.6
	380-60	1	3.9
	380/415-50	1	3.3
	460-60	1	3.3
	575-60	1	2.6
016	208/230-60	1	6.6
	380-60	1	3.9
	380/415-50	1	3.3
	460-60	1	3.3
	575-60	1	2.6
018	208/230-60	2	6.6
	380-60	2	3.9
	380/415-50	2	3.3
	460-60	2	3.3
	575-60	2	2.6
020	208/230-60	2	6.6
	380-60	2	3.9
	380/415-50	2	3.3
	460-60	2	3.3
	575-60	2	2.6
025	208/230-60	2	6.6
	380-60	2	3.9
	380/415-50	2	3.3
	460-60	2	3.3
	575-60	2	2.6
030	208/230-60	2	6.6
	380-60	2	3.9
	380/415-50	2	3.3
	460-60	2	3.3
	575-60	2	2.6
035	208/230-60	3	6.6
	380-60	3	3.9
	380/415-50	3	3.3
	460-60	3	3.3
	575-60	3	2.6
040	208/230-60	3	6.6
	380-60	3	3.9
	380/415-50	3	3.3
	460-60	3	3.3
	575-60	3	2.6
045	208/230-60	3	6.6
	380-60	3	3.9
	380/415-50	3	3.3
	460-60	3	3.3
	575-60	3	2.6
050	208/230-60	3	6.6
	380-60	3	3.9
	380/415-50	3	3.3
	460-60	3	3.3
	575-60	3	2.6
055	208/230-60	4	6.6
	380-60	4	3.9
	380/415-50	4	3.3
	460-60	4	3.3
	575-60	4	2.6
060	208/230-60	4	6.6
	380-60	4	3.9
	380/415-50	4	3.3
	460-60	4	3.3
	575-60	4	2.6

LEGEND

FLA — Full Load Amps

NOTES:

1. Units are suitable for use on electrical systems where voltage supplied to the unit terminals is not below or above the listed minimum and maximum limits. Maximum allowable phase imbalance is: voltage 2%; amps 10%.
2. All units/modules have single point primary power connection. (Each unit/module requires its own power supply.) Main power must be supplied from a field-supplied disconnect.
3. The unit control circuit power transformer (24 v, single-phase for all voltages) is factory supplied.
4. Cooler heater is wired into the control circuit so it is always operable as long as the power supply disconnect and heater safety device are on.
5. 30RAP chillers with Greenspeed intelligence are not available on unit sizes 070-150.

**Table 30 — Fan Electrical Data — Single Point, Optional Value Sound Fans
Unit Sizes 070-150**

UNIT 30RAP	UNIT VOLTAGE V-Hz (3 Ph)	OPTIONAL CONDENSER FANS	
		Quantity	FLA (each)
070	208/230-60	5	6.6
	380-60	5	3.9
	380/415-50	5	3.3
	460-60	5	3.3
	575-60	5	2.6
080	208/230-60	6	6.6
	380-60	6	3.9
	380/415-50	6	3.3
	460-60	6	3.3
	575-60	6	2.6
090	208/230-60	6	6.6
	380-60	6	3.9
	380/415-50	6	3.3
	460-60	6	3.3
	575-60	6	2.6
100	208/230-60	7	6.6
	380-60	7	3.9
	380/415-50	7	3.3
	460-60	7	3.3
	575-60	7	2.6
115	208/230-60	8	6.6
	380-60	8	3.9
	380/415-50	8	3.3
	460-60	8	3.3
	575-60	8	2.6
130	208/230-60	9	6.6
	380-60	9	3.9
	380/415-50	9	3.3
	460-60	9	3.3
	575-60	9	2.6
150	208/230-60	10	6.6
	380-60	10	3.9
	380/415-50	10	3.3
	460-60	10	3.3
	575-60	10	2.6

LEGEND

FLA — Full Load Amps

NOTES:

1. Units are suitable for use on electrical systems where voltage supplied to the unit terminals is not below or above the listed minimum and maximum limits. Maximum allowable phase imbalance is: voltage 2%; amps 10%.
2. All units/modules have single point primary power connection. (Each unit/module requires its own power supply.) Main power must be supplied from a field-supplied disconnect.
3. The unit control circuit power transformer (24 v, single-phase for all voltages) is factory supplied.
4. Cooler heater is wired into the control circuit so it is always operable as long as the power supply disconnect and heater safety device are on.
5. 30RAP chillers with Greenspeed[®] intelligence are not available on unit sizes 070-150.

Table 31 — Pump Electrical Data (60 Hz Only)

30RAP SIZE	PUMP OPTION	PUMP SIZE	PUMP RPM	UNIT VOLTAGE V-Hz (3 Ph)	FLA (each)
011-060	2, 9	1.5 HP	3500	208/230-60	4.3
			3500	380-60	2.4
			3500	460-60	2.1
			3500	575-60	1.6
	3, 4, B, C	3.0 HP	3500	208/230-60	7.9
			3500	380-60	4.4
			3500	460-60	3.7
			3500	575-60	3.0
	5, 6, D, F	5.0 HP	3500	208/230-60	12.6
			3500	380-60	7.0
3500			460-60	5.8	
3500			575-60	4.6	
7, G	7.5 HP	3500	208/230-60	18.5	
		3500	380-60	10.4	
		3500	460-60	8.7	
		3500	575-60	7.0	
Z, H	10.0 HP	3500	208/230-60	25.0	
		3500	380-60	14.0	
		3500	460-60	11.5	
		3500	575-60	9.2	
070-150	2, D	5.0 HP	1750	208/230-60	15.4
				380-60	8.1
				460-60	7.1
				575-60	5.4
	3, 8, F, L	7.5 HP	1750 - 150 ton single	208/230-60	22.0
				380-60	12.3
				460-60	10.1
				575-60	8.1
	4, 9, G, M	10.0 HP	3500	208/230-60	18.5
				380-60	10.4
460-60				8.7	
575-60				7.0	
5, B, H, N	15.0 HP	3500	208/230-60	25.0	
			380-60	14.0	
			460-60	11.5	
			575-60	9.2	
			208/230-60	36.7	
			380-60	21.0	
			460-60	17.0	
			575-60	14.0	

LEGEND
FLA — Full Load Amps

NOTES:

- Units are suitable for use on electrical systems where voltage supplied to the unit terminals is not below or above the listed minimum and maximum limits. Maximum allowable phase imbalance is: voltage 2%; amps 10%.

- All units/modules have single point primary power connection. (Each unit/module requires its own power supply.) Main power must be supplied from a field-supplied disconnect.
- The unit control circuit power transformer (24 v, single-phase for all voltages) is factory supplied.
- Cooler heater is wired into the control circuit so it is always operable as long as the power supply disconnect and heater safety device are on.
- 30RAP chillers with Greenspeed intelligence are not available on unit sizes 070-150.

Table 32 — Accessory Tank Electrical Data (011-060 sizes only)

UNIT VOLTAGE (V-Hz)	ACCESSORY PART NO. 30RA-900---	FLA
208/230-60	050	11.3
	051	11.3
	052	22.6
460-60	050	5.7
	051	5.7
	052	11.3
575-60	050	7.1
	051	7.1
	052	14.1
380-60	050	4.7
	051	4.7
	052	9.3
380/415-50	050	4.9
	051	4.9
	052	9.8

LEGEND
FLA — Full Load Amps

NOTE: The storage tank obtains its power from the chiller. No separate power source is required.

Table 33 — Compressor Electrical Data, Single/Dual Point, Unit Sizes 011-060

UNIT 30RAP	NUMBER OF COMPRESSORS PER CIRCUIT	UNIT VOLTAGE V-Hz (3 Ph)	CIRCUIT*			
			CIRCUIT A		CIRCUIT B	
			RLA	LRA	RLA	LRA
011	2	208/230-60	23.2 / 16.0	164 / 110	—	—
		380-60	12.2 / 8.5	73 / 66	—	—
		380/415-50	11.2 / 7.8	75 / 52	—	—
		460-60	11.2 / 7.8	75 / 52	—	—
		575-60	7.9 / 5.7	54 / 39	—	—
016	2	208/230-60	28.2 / 23.2	240 / 164	—	—
		380-60	16.0 / 12.2	135 / 73	—	—
		380/415-50	14.7 / 11.2	130 / 75	—	—
		460-60	14.7 / 11.2	130 / 75	—	—
		575-60	11.3 / 7.9	94 / 54	—	—
018	2	208/230-60	33.4	225	—	—
		380-60	19.2	140	—	—
		380/415-50	16.7	114	—	—
		460-60	16.7	114	—	—
		575-60	13.4	80	—	—
020	2	208/230-60	35.8	239	—	—
		380-60	23.7	145	—	—
		380/415-50	17.9	125	—	—
		460-60	17.9	125	—	—
		575-60	14.3	80	—	—
025	2	208/230-60	51.3	300	—	—
		380-60	26.9	139	—	—
		380/415-50	23.1	150	—	—
		460-60	23.1	150	—	—
		575-60	19.9	109	—	—
030	2	208/230-60	55.8	340	—	—
		380-60	34.0	196	—	—
		380/415-50	26.9	179	—	—
		460-60	26.9	179	—	—
		575-60	23.7	132	—	—
035	2	208/230-60	35.8	239	33.4	225
		380-60	23.7	145	19.2	140
		380/415-50	17.9	125	16.7	114
		460-60	17.9	125	16.7	114
		575-60	14.3	80	13.4	80
040	2	208/230-60	35.8	239	48.1	245
		380-60	23.7	145	23.7	145
		380/415-50	17.9	125	18.6	125
		460-60	17.9	125	18.6	125
		575-60	14.3	80	14.7	100
045	2	208/230-60	48.1	245	51.3	300
		380-60	23.7	145	23.7	145
		380/415-50	18.6	125	23.1	150
		460-60	18.6	125	23.1	150
		575-60	14.7	100	19.9	109
050	2	208/230-60	51.3	300	51.3	300
		380-60	26.9	139	26.9	139
		380/415-50	23.1	150	23.1	150
		460-60	23.1	150	23.1	150
		575-60	19.9	109	19.9	109
055	2	208/230-60	51.3	300	55.8	340
		380-60	26.9	139	34.0	196
		380/415-50	23.1	150	26.9	179
		460-60	23.1	150	26.9	179
		575-60	19.9	109	23.7	132
060	2	208/230-60	55.8	340	55.8	340
		380-60	34.0	196	34.0	196
		380/415-50	26.9	179	26.9	179
		460-60	26.9	179	26.9	179
		575-60	23.7	132	23.7	132

LEGEND

LRA — Locked Rotor Amps
RLA — Rated Load Amps

* All data is per individual compressor. A1/A2 for unit sizes 011 and 016.

NOTE: 30RAP chillers with Greenspeed® intelligence are not available on unit sizes 070-150.

Table 34 — Compressor Electrical Data, Single/Dual Point, Unit Sizes 070-150

UNIT 30RAP	NUMBER OF COMPRESSORS PER CIRCUIT (A/B)	UNIT VOLTAGE V-Hz (3 Ph)	CIRCUIT*			
			CIRCUIT A		CIRCUIT B	
			RLA	LRA	RLA	LRA
070	2/3	208/230-60	55.8	340	55.8	340
		380-60	34.0	196	34.0	196
		380/415-50	26.9	179	26.9	179
		460-60	26.9	179	26.9	179
		575-60	23.7	132	23.7	132
080	3	208/230-60	51.3	300	55.8	340
		380-60	26.9	139	34.0	196
		380/415-50	23.1	150	26.9	179
		460-60	23.1	150	26.9	179
		575-60	19.9	109	23.7	132
090	3	208/230-60	55.8	340	55.8	340
		380-60	34.0	196	34.0	196
		380/415-50	26.9	179	26.9	179
		460-60	26.9	179	26.9	179
		575-60	23.7	132	23.7	132
100	2/3	208/230-60	75.0 / 94.2	485 / 560	75.0	485.0
		380-60	38.4 / 49.3	260 / 315	38.4	260.0
		380/415-50	32.7 / 41.6	215 / 260	32.7	215.0
		460-60	32.7 / 41.6	215 / 260	32.7	215.0
		575-60	26.2 / 33.9	175 / 210	26.2	175.0
115	3	208/230-60	75.0	485	75.0	485
		380-60	38.4	260	38.4	260
		380/415-50	32.7	215	32.7	215
		460-60	32.7	215	32.7	215
		575-60	26.2	175	26.2	175
130	3	208/230-60	75.0	485	94.2	560
		380-60	38.4	260	49.3	315
		380/415-50	32.7	215	41.6	260
		460-60	32.7	215	41.6	260
		575-60	26.2	175	33.9	210
150	3	208/230-60	94.2	560	94.2	560
		380-60	49.3	315	49.3	315
		380/415-50	32.7	260	41.6	260
		460-60	41.6	260	41.6	260
		575-60	33.9	210	33.9	210

LEGEND

LRA — Locked Rotor Amps
RLA — Rated Load Amps

* All data is per individual compressor. A1/A2 for unit size 100.
 NOTE: 30RAP chillers with Greenspeed intelligence are not available on unit sizes 070-150.



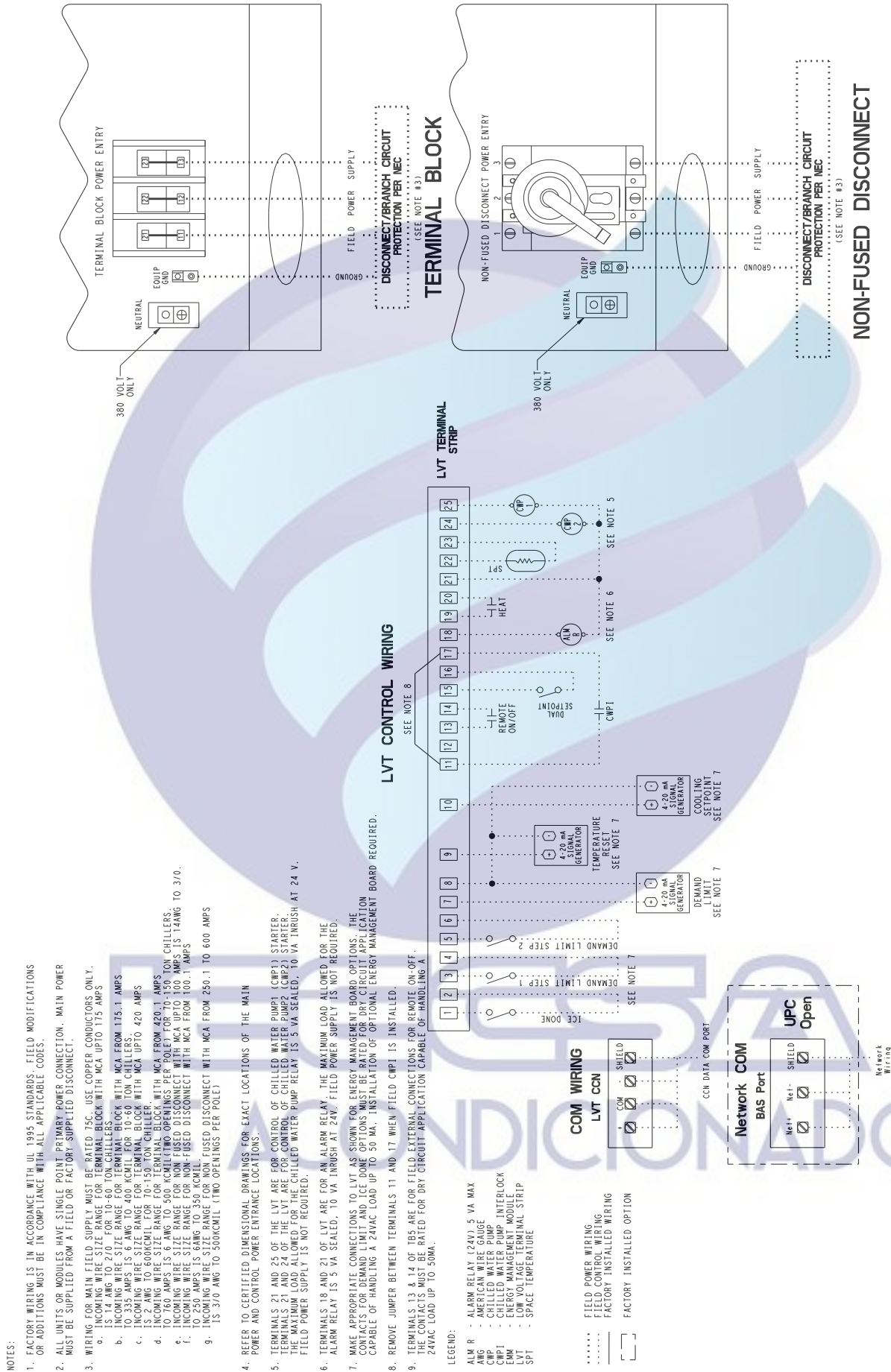

Fig. 36 — Typical Main Power and Control Connections

CONTROL POWER

IMPORTANT: To ensure power to the heaters, make sure auxiliary power to the unit and the compressor circuit breakers is always on (except for servicing or prolonged shutdown). Since water cannot be drained completely, add an appropriate amount of inhibited glycol as noted for winter shutdown.

⚠ CAUTION

Proper rotation of condenser fan(s), pumps and compressors **MUST** be verified. Consult the Controls, Start-Up, Operation, Service, and Troubleshooting manual provided with this chiller for correct procedure. If pump(s) have been removed for trimming, verify that wiring is reconnected in the original manner. Failure to follow these procedures may result in damage to equipment.

Control power is obtained from the main power supply and does **NOT** require a separate source. A toggle switch (marked Emergency On-Off on the unit label diagram and by the switch) allows the control circuit to be manually disconnected when necessary.

IMPORTANT: For 208-v systems, the primary connection tap for all transformers must be changed. The factory default setting is for 230 v. Failure to connect to the proper tap may result in unreliable operation.

Step 6 — Install Accessories

ELECTRICAL — A number of electrical accessories are available to provide the following optional features (for details, refer to the Controls, Start-Up, Operation, Service, and Troubleshooting book):

Energy Management Module (Used for any of the following types of temperature reset, demand limit and ice features):

- 4 to 20 mA leaving fluid temperature reset (requires field-supplied 4 to 20 mA generator)
- 4 to 20 mA cooling set point reset (requires field-supplied 4 to 20 mA generator)
- Discrete inputs for 2-step demand limit (requires field-supplied dry contacts)
- 4 to 20 mA demand limit (requires field-supplied 4 to 20 mA generator)
- Discrete input for Ice Done switch (requires field-supplied dry contacts)

Navigator™ Display — The device provides hand-held, mobile capability using an easy to read 4-line display. The keypad function is the same as the scrolling marquee module. A magnet is provided for “hands free” service of components.

Low Ambient Operation — If outdoor ambient operating temperatures below 45°F (7°C) on size 018-030 units or 32 °F (0°C) on size 035-150 units are expected, refer to separate installation instructions for low ambient operation using accessory Motormaster® V control. The Motormaster low

ambient control option is not available on any unit which employs high-efficiency variable condenser fans (because units with such fans already have low ambient capability).

Minimum Load Accessory — If minimum load accessory is required, refer to unit Price Pages or contact your local Carrier representative for more details. For installation details, refer to separate installation instructions supplied with the accessory package.

Miscellaneous Accessories — For applications requiring special accessories, the following packages are available: external vibration isolation, remote enhanced display, temperature reset, hail guard/security grilles, storage tank, wind baffles, and remote cooler. For installation details, refer to separate installation instructions supplied with these accessory packages.

Step 7 — Check Refrigerant Circuit

LEAK TESTING — Units are shipped with complete operating charge of R-410A (refer to physical data tables) and should be under sufficient pressure to conduct a leak test. Perform a leak test to ensure that leaks have not developed during unit shipment. Dehydration of the system is not required unless the entire refrigerant charge has been lost. Repair any leak found using good refrigeration practice.

DEHYDRATION — Refer to Carrier Standard Service Techniques Manual, Chapter 1, Refrigerants, Sections 6 and 7 for details. *Do not use compressor to evacuate system.*

REFRIGERANT CHARGE (Refer to Tables 6 and 7) — Immediately after the condenser coil in each circuit is a 1/4-in. Schrader connection for charging liquid refrigerant.

Utilization of Novation® heat exchanger technology coils enables the 30RAP chiller to have a very low refrigerant charge. Therefore, if field charging is required, accurately charging to the correct quantity is very important. It is necessary to ensure that the system is completely evacuated before charging and that the refrigerant charge is accurately weighed to within 1% of the nameplate quantity or the unit may not operate correctly.

⚠ CAUTION

When charging, circulate water through the cooler at all times to prevent freezing. Freezing damage is considered abuse and may impair or otherwise negatively affect the Carrier warranty.

⚠ CAUTION

DO NOT OVERCHARGE system. Overcharging results in higher discharge pressure, increased power consumption, and possible compressor damage.

The suction lines are provided with a 1/4-in. Schrader fitting for connecting to low-side system pressure. The location of the suction access port is shown in Fig. 37.

AIRE ACONDICIONADO

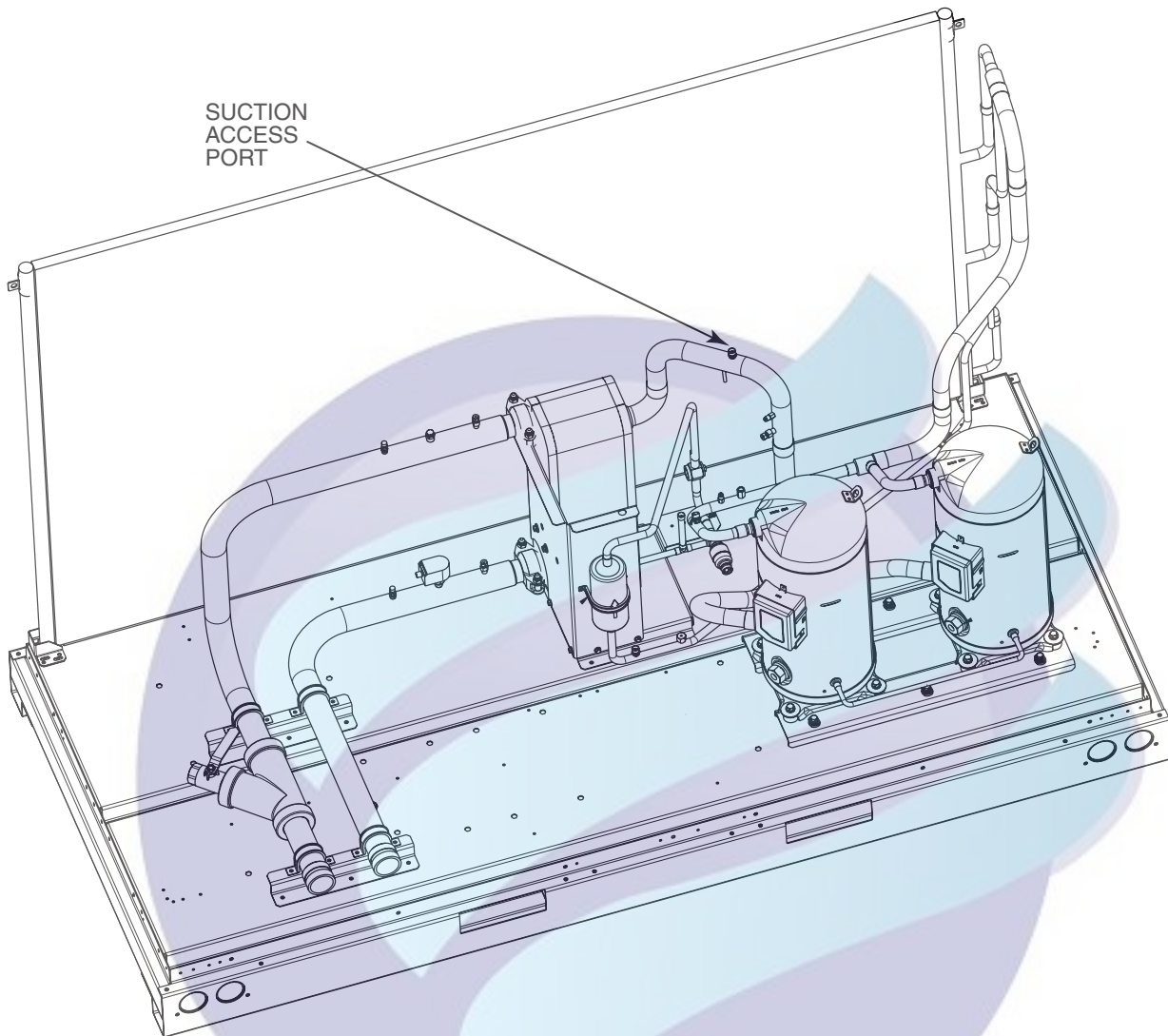

Fig. 37 — Suction Access Port (Sizes 018-030 Shown)

BACnet Communication Option Wiring — The BACnet communication option uses the UPC Open controller. The controller communicates using BACnet on an MS/TP network segment communications at 9600 bps, 19.2 kbps, 38.4 kbps, or 76.8 kbps.

Wire the controllers on an MS/TP network segment in a daisy-chain configuration. Wire specifications for the cable are 22 AWG (American Wire Gauge) or 24 AWG, low-capacitance, twisted, stranded, shielded copper wire. The maximum length is 2000 ft.

Install a BT485 terminator on the first and last controller on a network segment to add bias and prevent signal distortions due to echoing. See Fig. 38-40.

To wire the UPC Open controller to the BAS (Building Automation System) network:

1. Pull the screw terminal connector from the controller's BAS Port.
2. Check the communications wiring for shorts and grounds.
3. Connect the communications wiring to the BAS port's screw terminals labeled Net +, Net -, and Shield.

NOTE: Use the same polarity throughout the network segment.

4. Insert the power screw terminal connector into the UPC Open controller's power terminals if they are not currently connected.
5. Verify communication with the network by viewing a module status report. To perform a module status report using the BACview keypad/display unit, press and hold the "FN" key; then press the "." key.

To install a BT485 terminator, push the BT485 terminator on to the BT485 connector located near the BACnet connector.

NOTE: The BT485 terminator has no polarity associated with it.

To order a BT485 terminator, consult Commercial Products i-Vu® Open Control System Master Prices.

MS/TP WIRING RECOMMENDATIONS — Recommendations are shown in Tables 35 and 36. The wire jacket and UL temperature rating specifications list two acceptable alternatives. The Halar¹ specification has a higher temperature rating and a tougher outer jacket than the SmokeGard² specification, and it is appropriate for use in applications where the user is concerned about abrasion. The Halar jacket is also less likely to crack in extremely low temperatures.

NOTE: Use the specified type of wire and cable for maximum signal integrity.

1. Halar is a registered trademark of Solvay Plastics.
2. SmokeGard is a trademark of AlphaGary-Mexichem Corp.

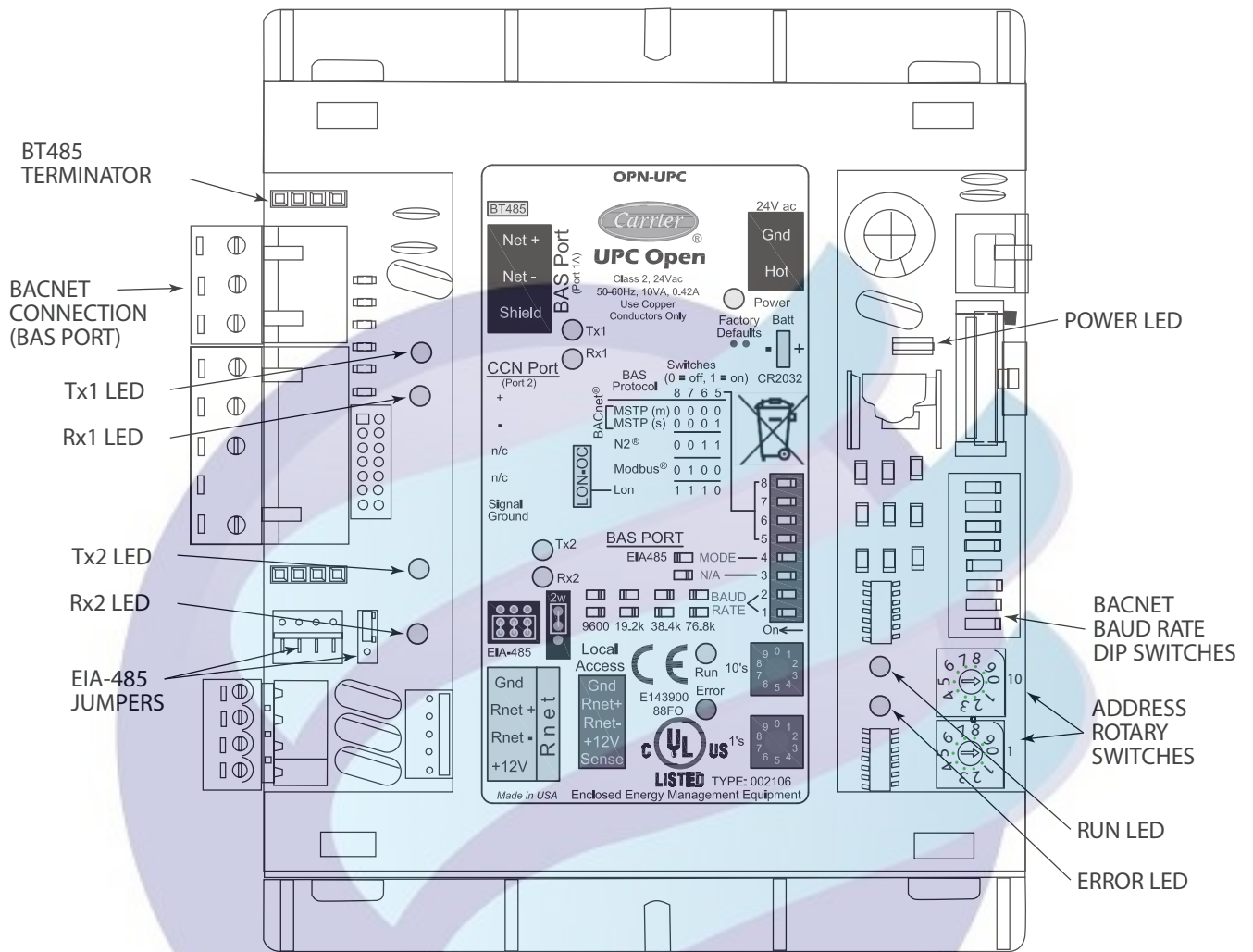

Fig. 38 — UPC Open Controller

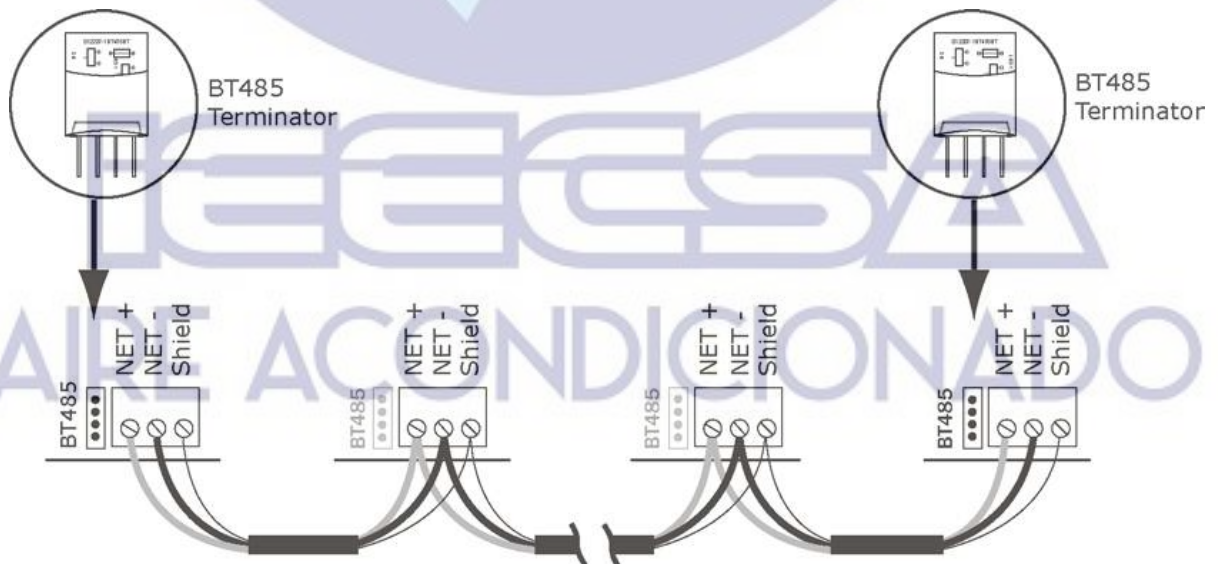

Fig. 39 — Network Wiring

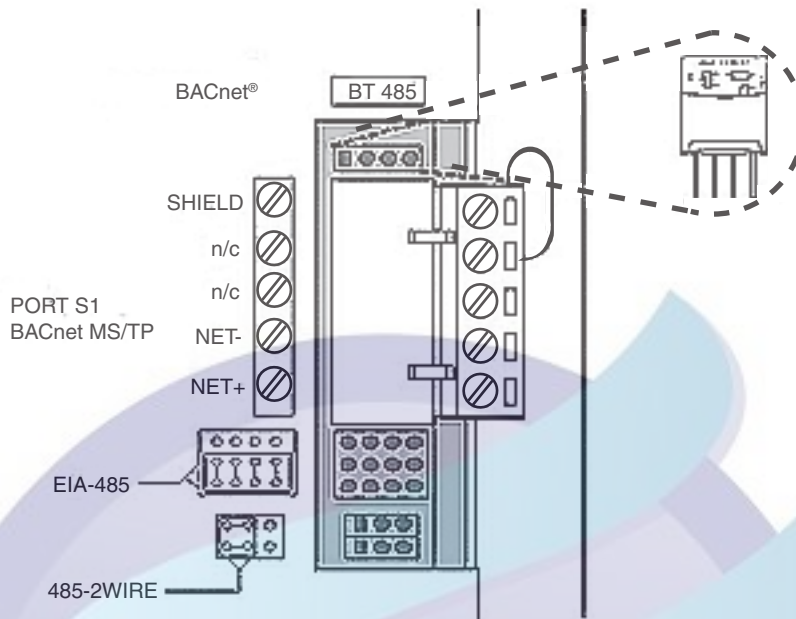

Fig. 40 — BT485 Terminator Installation

Table 35 — MS/TP Wiring Recommendations

SPECIFICATION	RECOMMENDATION
Cable	Single twisted pair, low capacitance, CL2P, 22 AWG (7x30), TC foam FEP, plenum rated cable
Conductor	22 or 24 AWG stranded copper (tin plated)
Insulation	Foamed FEP 0.015 in. (0.381 mm) wall 0.060 in. (1.524 mm) O.D.
Color Code	Black/White
Twist Lay	2 in. (50.8 mm) lay on pair 6 twists/foot (20 twists/meter) nominal
Shielding	Aluminum/Mylar shield with 24 AWG TC drain wire
Jacket	SmokeGard Jacket (SmokeGard PVC) 0.021 in. (0.5334 mm) wall 0.175 in. (4.445 mm) O.D. Halar Jacket (E-CTFE) 0.010 in. (0.254 mm) wall 0.144 in. (3.6576 mm) O.D.
DC Resistance	15.2 Ohms/1000 feet (50 Ohms/km) nominal
Capacitance	12.5 pF/ft (41 pF/meter) nominal conductor to conductor
Characteristic Impedance	100 Ohms nominal
Weight	12 lb/1000 feet (17.9 kg/km)
UL Temperature Rating	SmokeGard 167°F (75°C) Halar -40 to 302°F (-40 to 150°C)
Voltage	300 Vac, power limited
Listing	UL: NEC CL2P, or better

LEGEND

- AWG — American Wire Gage
- CL2P — Class 2 Plenum Cable
- DC — Direct Current
- FEP — Fluorinated Ethylene Polymer
- NEC — National Electrical Code
- O.D. — Outside Diameter
- TC — Tinned Copper
- UL — Underwriters Laboratories

Table 36 — Open System Wiring Specifications and Recommended Vendors

WIRING SPECIFICATIONS		RECOMMENDED VENDORS AND PART NUMBERS			
Wire Type	Description	Connect Air International	Belden	RMCORP	Contractors Wire and Cable
MS/TP Network (RS-485)	22 AWG, single twisted shielded pair, low capacitance, CL2P, TC foam FEP, plenum rated. See MS/TP Installation Guide for specifications.	W221P-22227	—	25160PV	CLP0520LC
	24 AWG, single twisted shielded pair, low capacitance, CL2P, TC foam FEP, plenum rated. See MS/TP Installation Guide for specifications.	W241P-2000F	82841	25120-OR	—
Rnet	4 conductor, unshielded, CMP, 18 AWG, plenum rated.	W184C-2099BLB	6302UE	21450	CLP0442

LEGEND

- AWG — American Wire Gage
- CL2P — Class 2 Plenum Cable
- CMP — Communications Plenum Rated
- FEP — Fluorinated Ethylene Polymer
- TC — Tinned Copper

APPENDIX A
Unit Pressure Drop Curves, 30RAP011-060 (English)

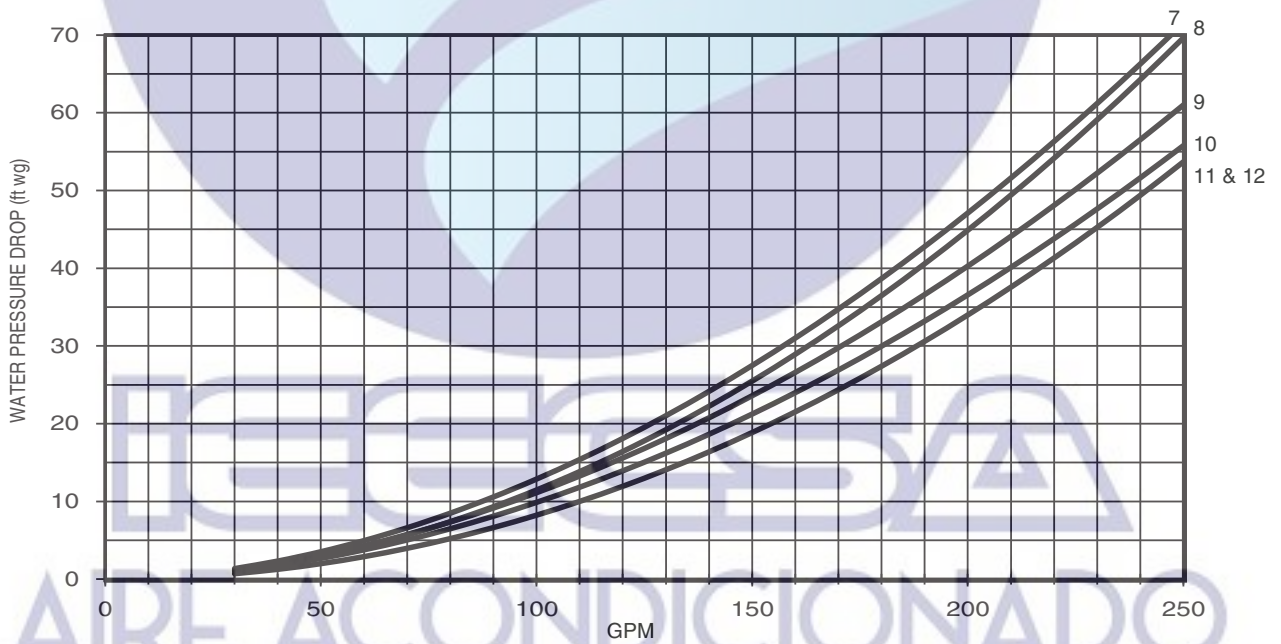
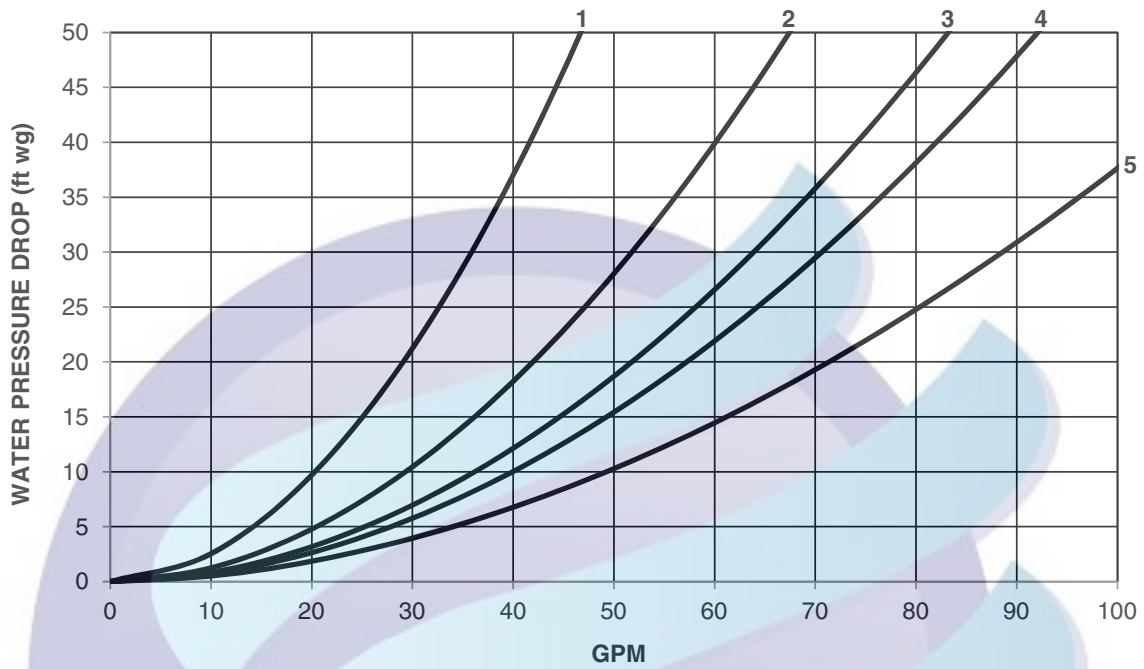

NOTES:

1. Use the following formula to convert feet of water to psig:
ft of water (.4335) = psig
2. Use the following formula to convert psig to feet of water:
psig (2.306) = ft of water
3. Pressure drop curves are suitable for water only.
4. Includes strainer and unit piping.

LEGEND

1 — 30RAP011	4 — 30RAP025	7 — 30RAP035	10 — 30RAP050
2 — 30RAP016,018	5 — 30RAP030	8 — 30RAP040	11 — 30RAP055
3 — 30RAP020		9 — 30RAP045	12 — 30RAP060

UNITS WITHOUT HYDRONIC PACKAGE

APPENDIX A (cont)
Unit Pressure Drop Curves, 30RAP011-060 (SI)

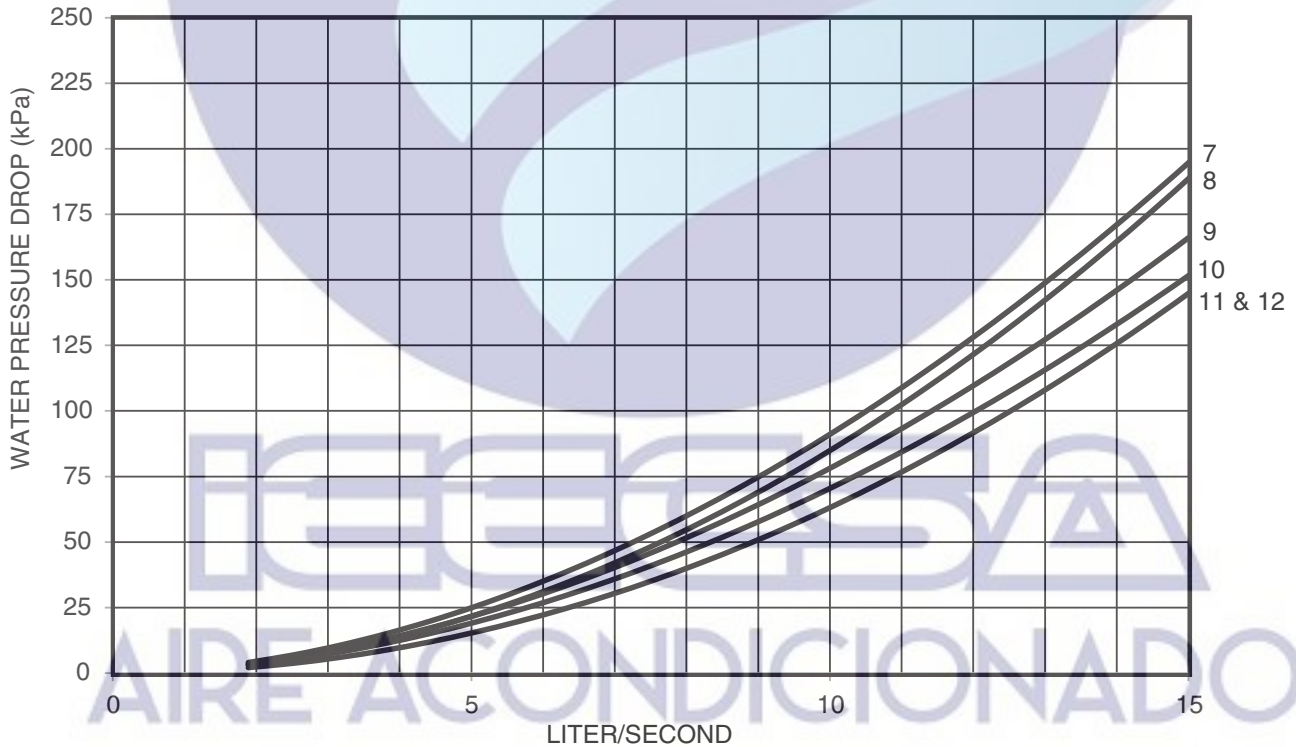
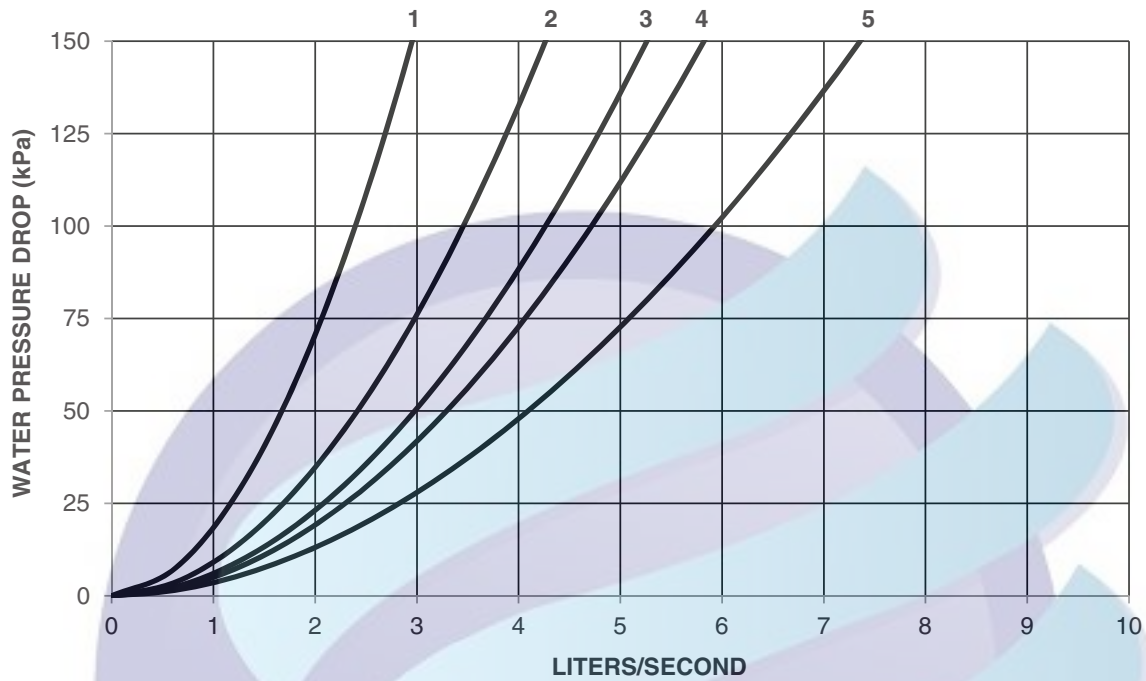

NOTES:
 1. Pressure drop curves are suitable for water only.
 2. Includes strainer and unit piping.

LEGEND			
1 — 30RAP011	4 — 30RAP025	7 — 30RAP035	10 — 30RAP050
2 — 30RAP016,018	5 — 30RAP030	8 — 30RAP040	11 — 30RAP055
3 — 30RAP020		9 — 30RAP045	12 — 30RAP060

UNITS WITHOUT HYDRONIC PACKAGE (cont)

APPENDIX A (cont)

Unit Pressure Drop Curves, 30RAP070-090 (English)

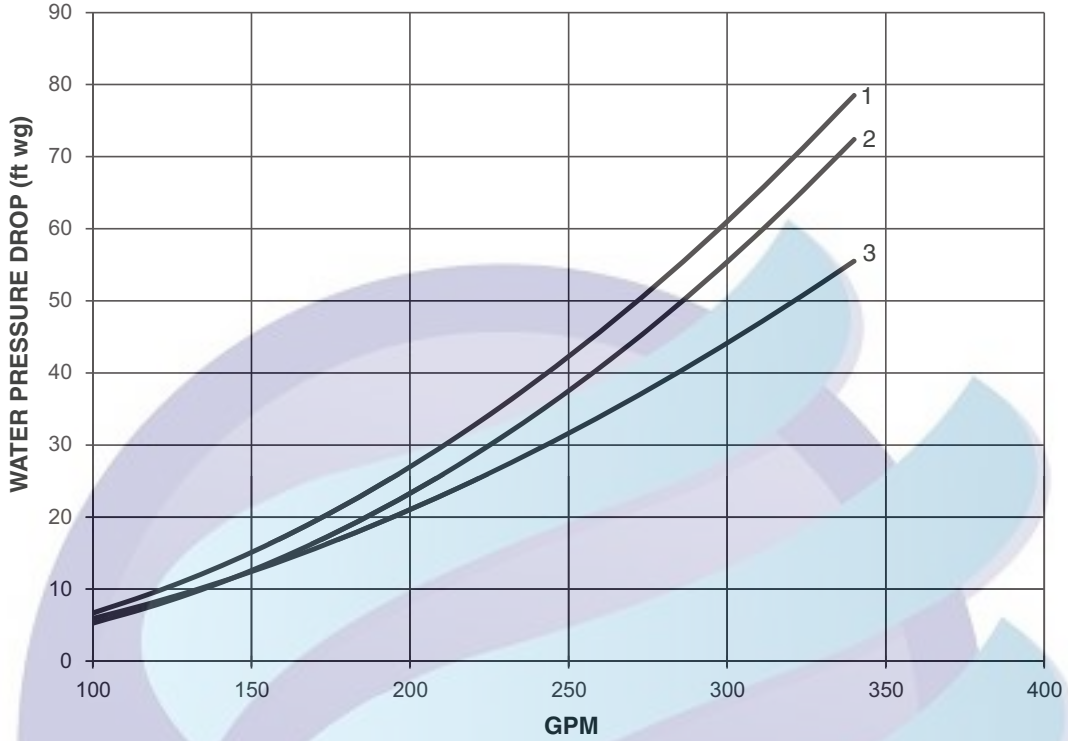

NOTES:

1. Use the following formula to convert feet of water to psig:
ft of water (.4335) = psig
2. Use the following formula to convert psig to feet of water:
psig (2.306) = ft of water
3. Pressure drop curves are suitable for water only.
4. Includes strainer and unit piping.

- LEGEND**
- 1 — 30RAP070
 - 2 — 30RAP080
 - 3 — 30RAP090

Unit Pressure Drop Curves, 30RAP070-090 (SI)

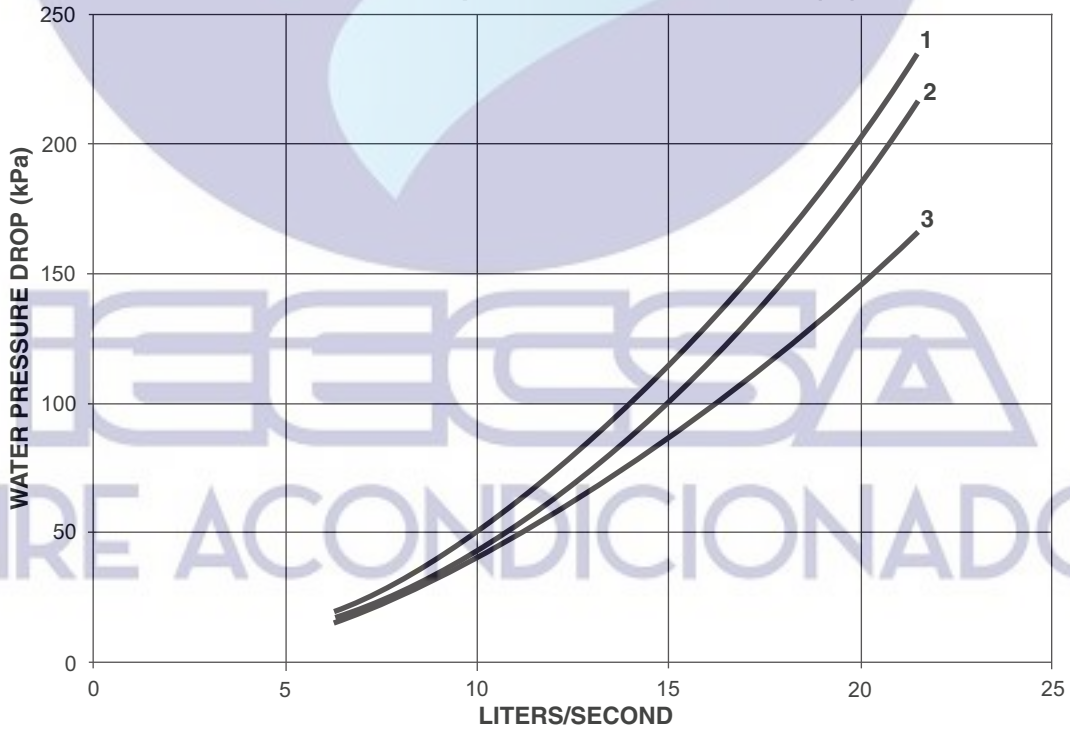

NOTES:

1. Pressure drop curves are suitable for water only.
2. Includes strainer and unit piping.

- LEGEND**
- 1 — 30RAP070
 - 2 — 30RAP080
 - 3 — 30RAP090

UNITS WITHOUT HYDRONIC PACKAGE (cont)

APPENDIX A (cont)

Unit Pressure Drop Curves, 30RAP100-150 (English)

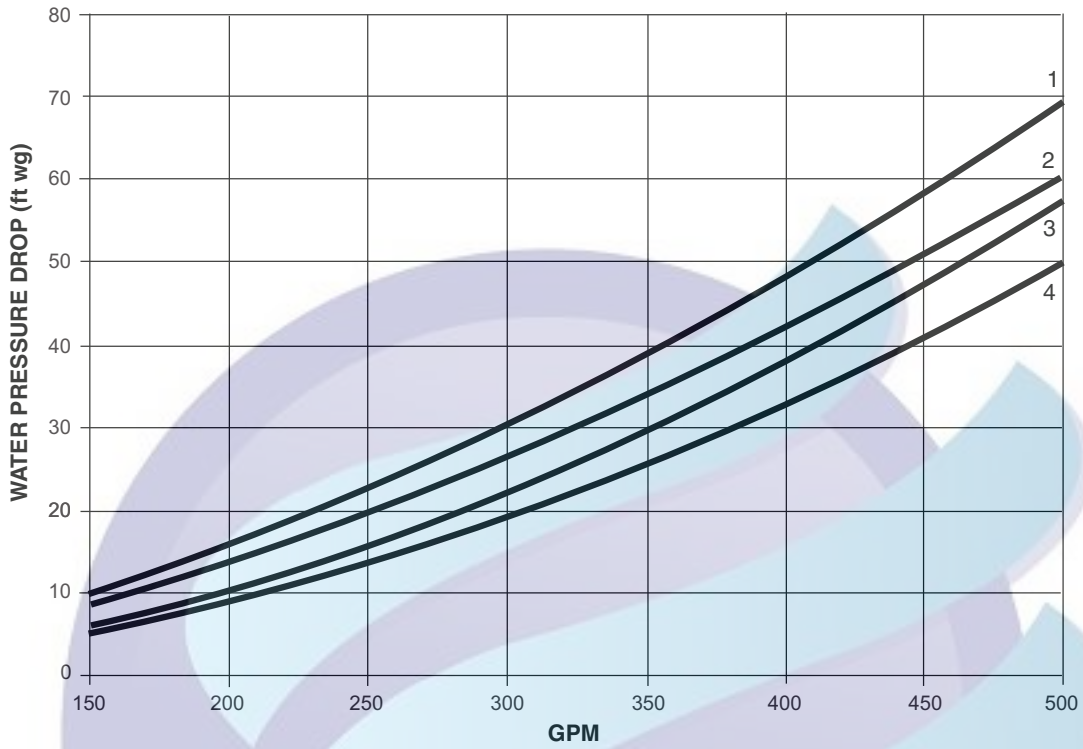

NOTES:

1. Use the following formula to convert feet of water to psig:
ft of water (.4335) = psig
2. Use the following formula to convert psig to feet of water:
psig (2.306) = ft of water
3. Pressure drop curves are suitable for water only.
4. Includes strainer and unit piping.

LEGEND

- 1 — 30RAP100
- 2 — 30RAP115
- 3 — 30RAP130
- 4 — 30RAP150

Unit Pressure Drop Curves, 30RAP100-150 (SI)

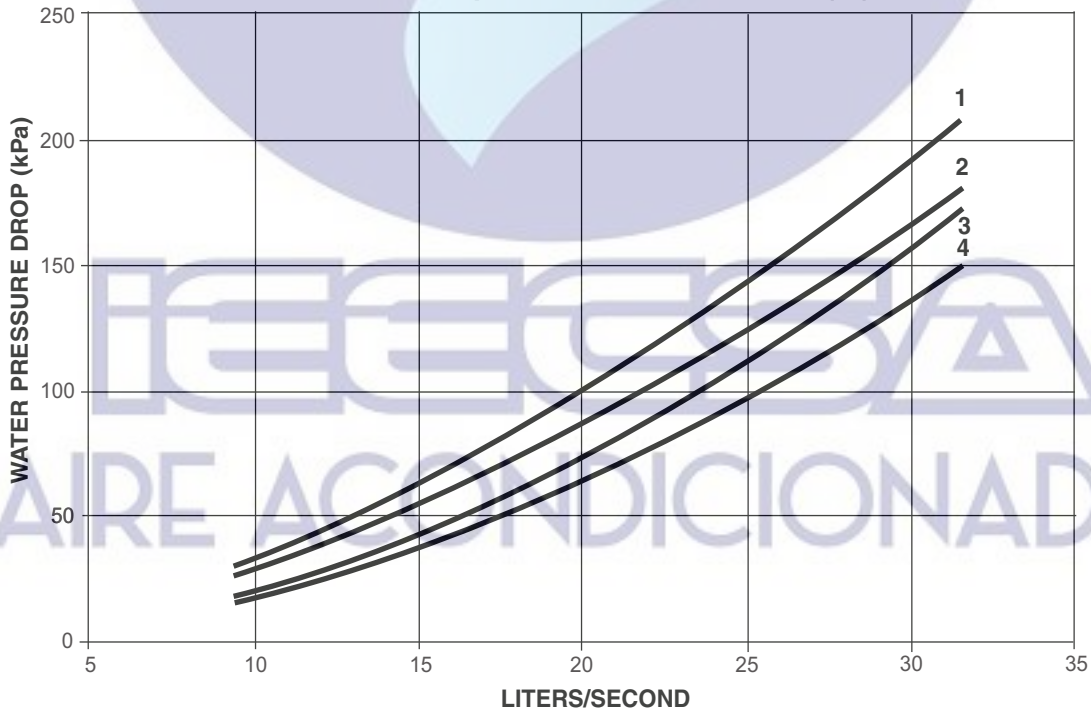

NOTES:

1. Pressure drop curves are suitable for water only.
2. Includes strainer and unit piping.

LEGEND

- 1 — 30RAP100
- 2 — 30RAP115
- 3 — 30RAP130
- 4 — 30RAP150

UNITS WITHOUT HYDRONIC PACKAGE (cont)

APPENDIX A (cont)
Unit Pressure Drop Curves, 30RAP011-060 (English)

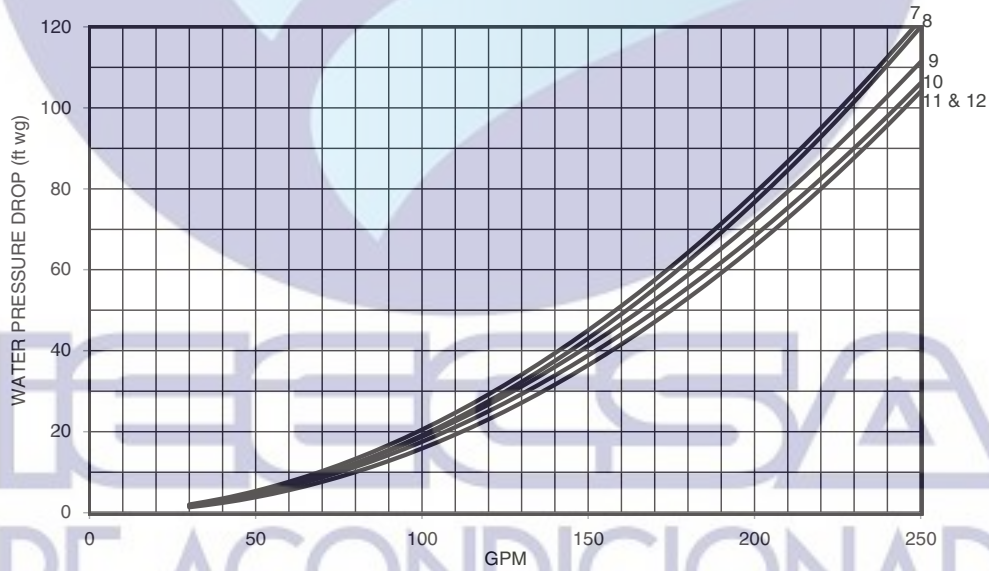
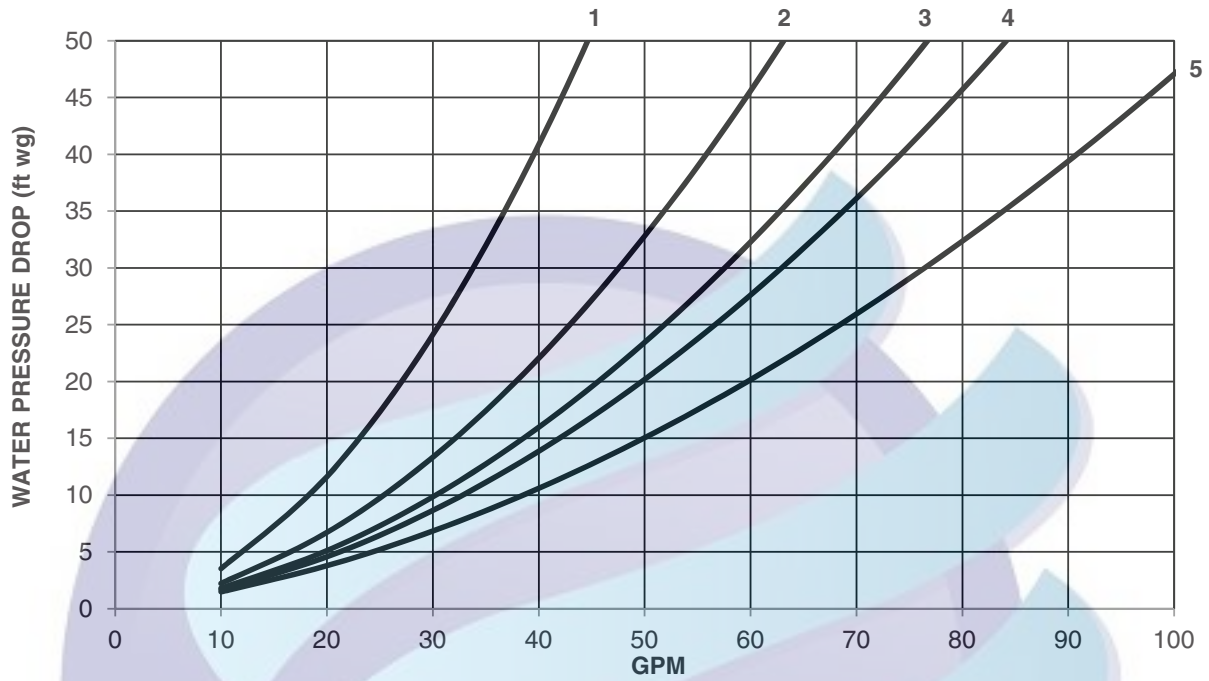

- NOTES:**
- Use the following formula to convert feet of water to psig:
ft of water (.4335) = psig
 - Use the following formula to convert psig to feet of water:
psig (2.306) = ft of water
 - Pressure drop curves are suitable for water only.
 - Includes strainer and unit piping.

LEGEND			
1 — 30RAP011	4 — 30RAP025	7 — 30RAP035	10 — 30RAP050
2 — 30RAP016,018	5 — 30RAP030	8 — 30RAP040	11 — 30RAP055
3 — 30RAP020		9 — 30RAP045	12 — 30RAP060

UNITS WITH SINGLE PUMP HYDRONIC PACKAGE

APPENDIX A (cont)
Unit Pressure Drop Curves, 30RAP011-060 (SI)

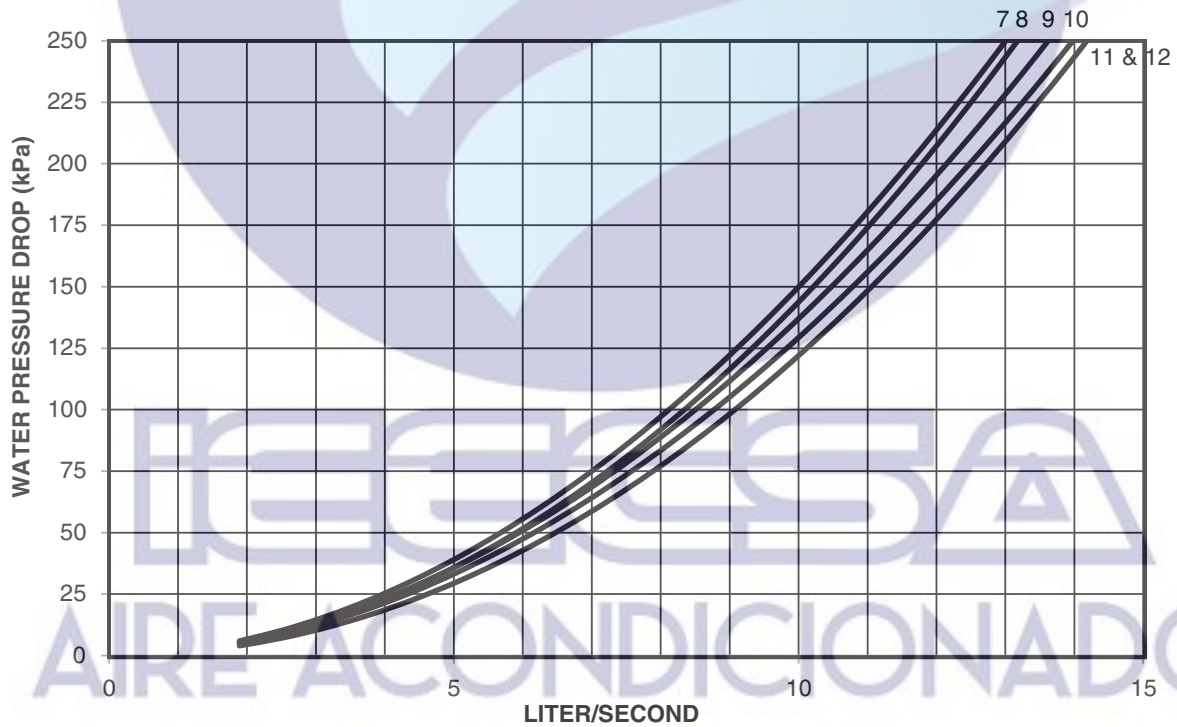
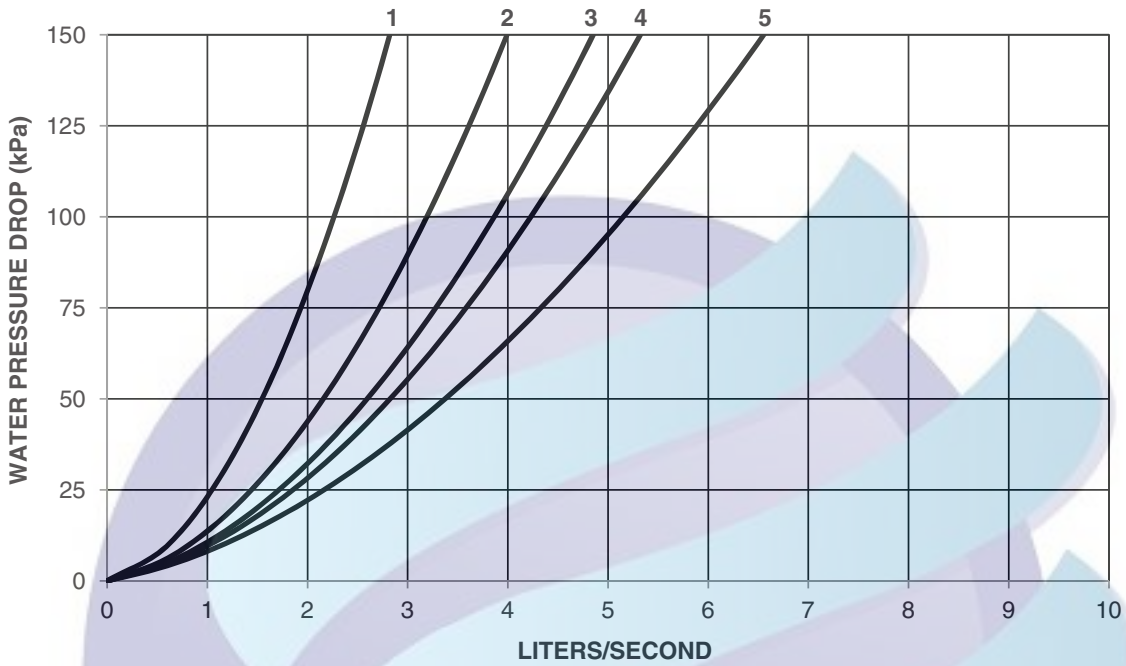

NOTES:
 1. Pressure drop curves are suitable for water only.
 2. Includes strainer and unit piping.

LEGEND			
1 — 30RAP011	4 — 30RAP025	7 — 30RAP035	10 — 30RAP050
2 — 30RAP016,018	5 — 30RAP030	8 — 30RAP040	11 — 30RAP055
3 — 30RAP020		9 — 30RAP045	12 — 30RAP060

UNITS WITH SINGLE PUMP HYDRONIC PACKAGE (cont)

APPENDIX A (cont)

Unit Pressure Drop Curves, 30RAP070-090 (English)

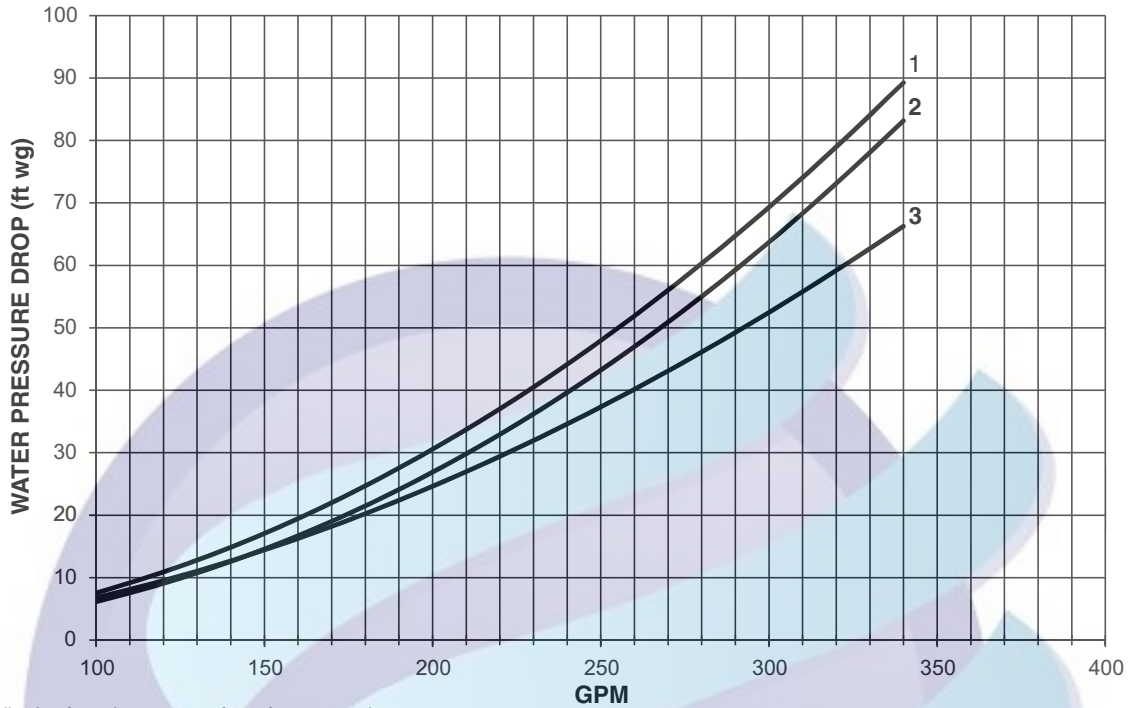

NOTES:

1. Use the following formula to convert feet of water to psig:
ft of water (.4335) = psig
2. Use the following formula to convert psig to feet of water:
psig (2.306) = ft of water
3. Pressure drop curves are suitable for water only.
4. Includes strainer and unit piping.

LEGEND

- 1 — 30RAP070
- 2 — 30RAP080
- 3 — 30RAP090

Unit Pressure Drop Curves, 30RAP070-090 (SI)

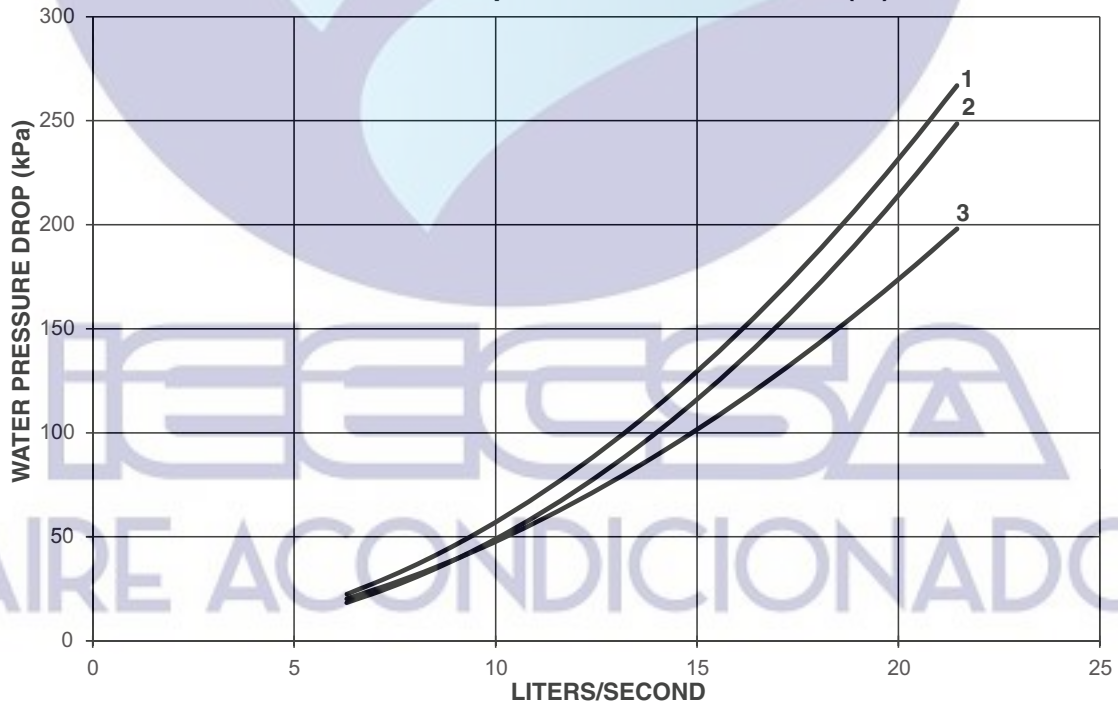

NOTES:

1. Pressure drop curves are suitable for water only.
2. Includes strainer and unit piping.

LEGEND

- 1 — 30RAP070
- 2 — 30RAP080
- 3 — 30RAP090

UNITS WITH SINGLE PUMP HYDRONIC PACKAGE (cont)

APPENDIX A (cont)

Unit Pressure Drop Curves, 30RAP100-150 (English)

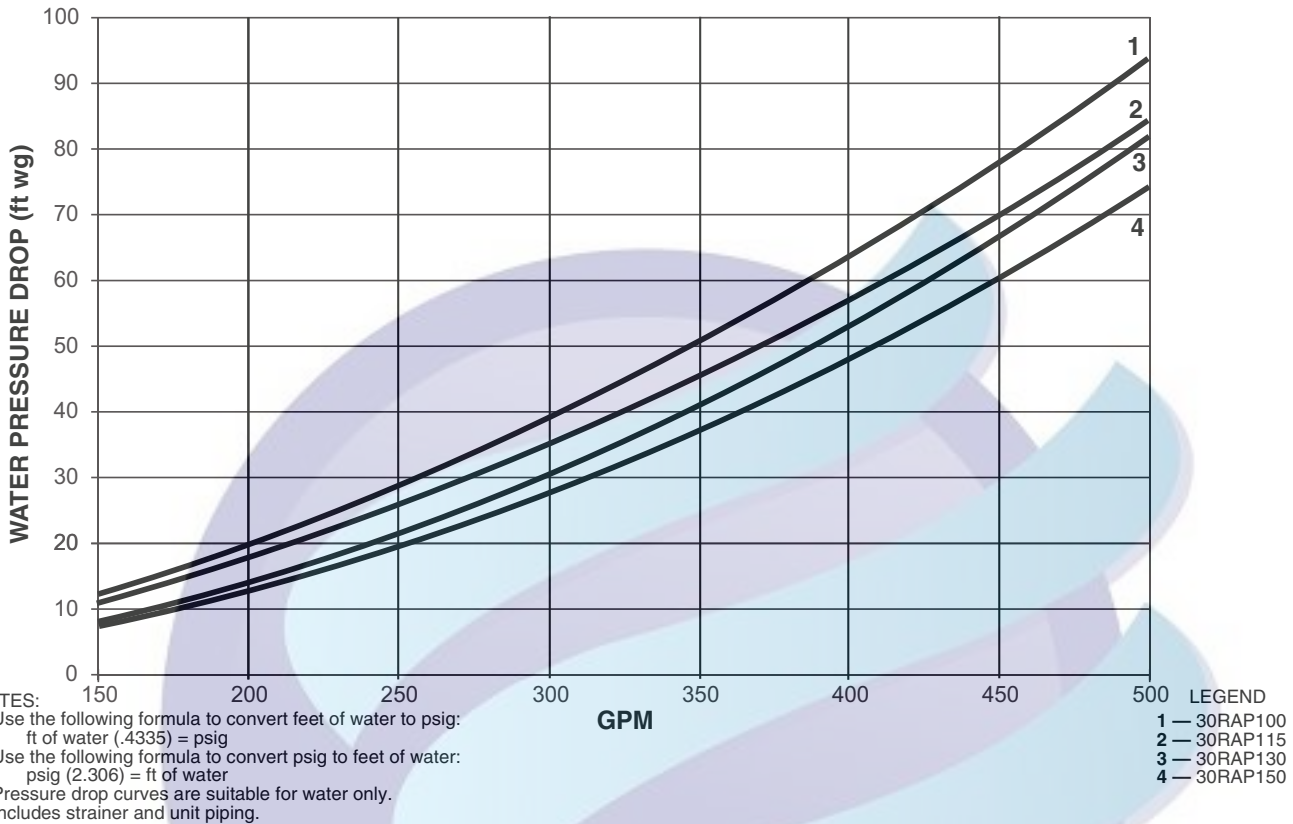

Unit Pressure Drop Curves, 30RAP100-150 (SI)

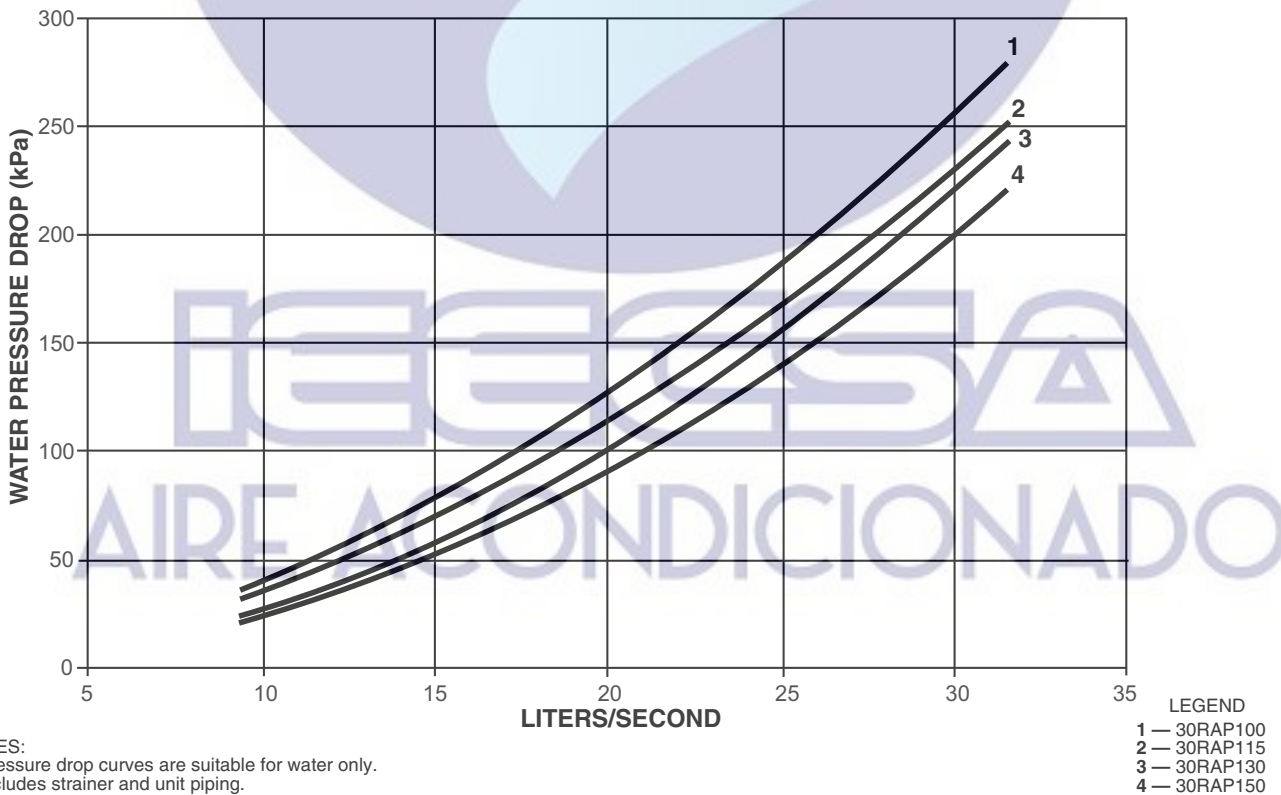

UNITS WITH SINGLE PUMP HYDRONIC PACKAGE (cont)

APPENDIX A (cont)
Unit Pressure Drop Curves, 30RAP011-060 (English)

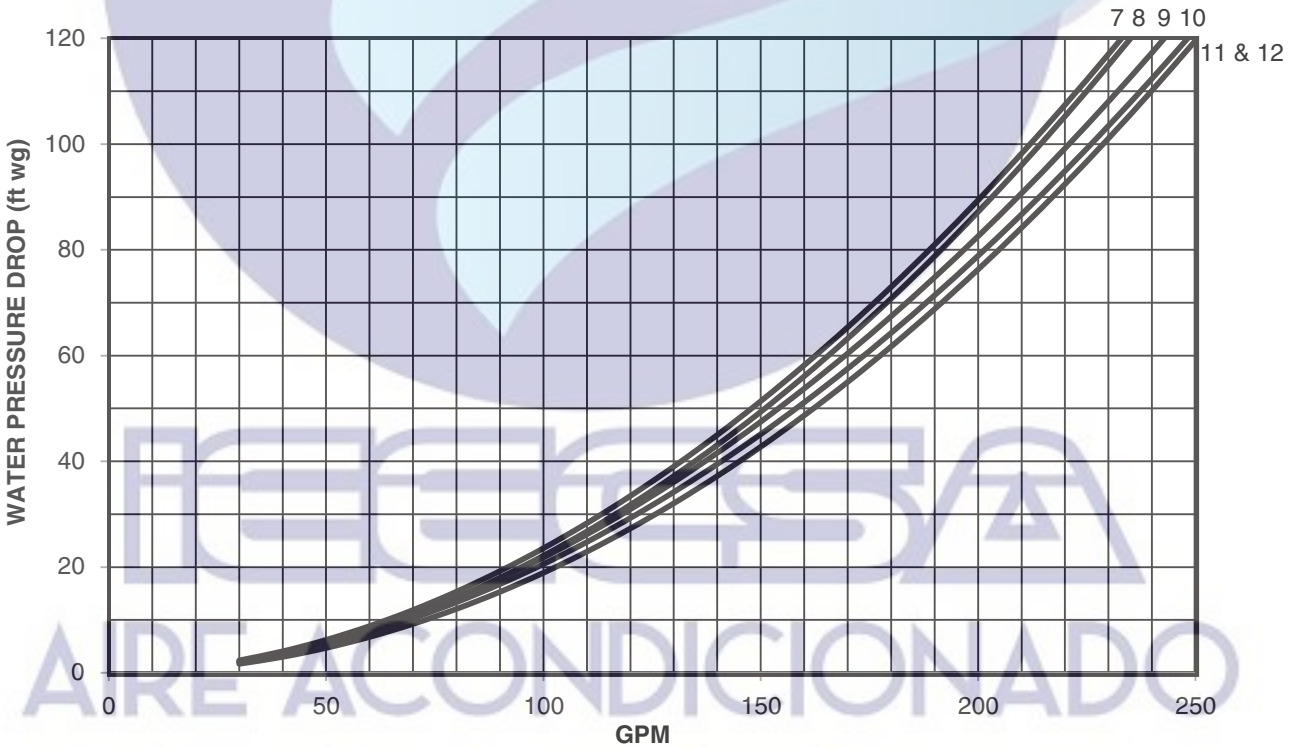
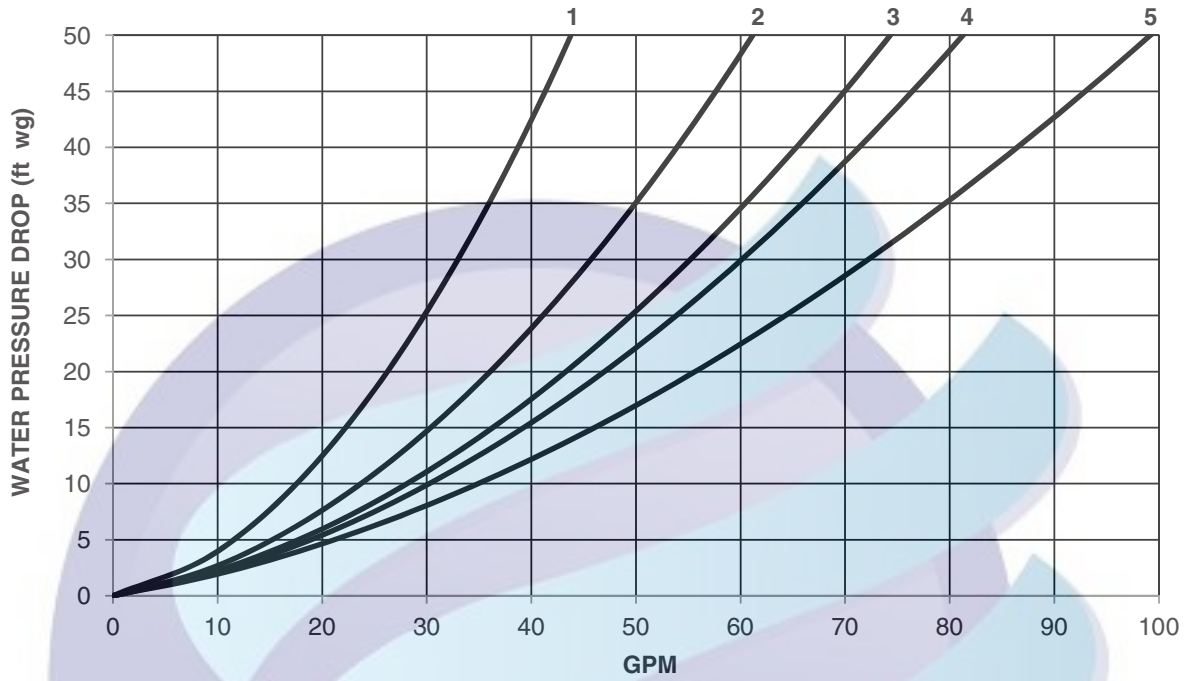

NOTES:

1. Use the following formula to convert feet of water to psig:
ft of water (.4335) = psig
2. Use the following formula to convert psig to feet of water:
psig (2.306) = ft of water
3. Pressure drop curves are suitable for water only.
4. Includes strainer and unit piping.

LEGEND

1 — 30RAP011	4 — 30RAP025	7 — 30RAP035	10 — 30RAP050
2 — 30RAP016,018	5 — 30RAP030	8 — 30RAP040	11 — 30RAP055
3 — 30RAP020		9 — 30RAP045	12 — 30RAP060

UNITS WITH DUAL PUMP HYDRONIC PACKAGE

APPENDIX A (cont)
Unit Pressure Drop Curves, 30RAP011-060 (SI)

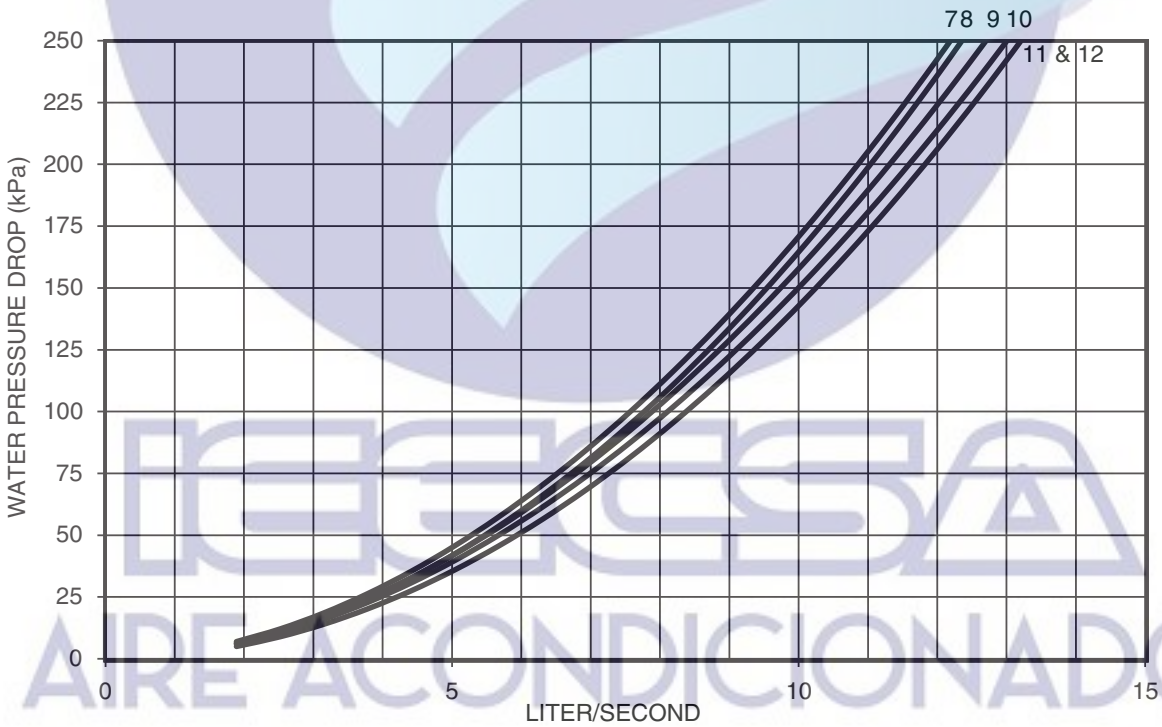
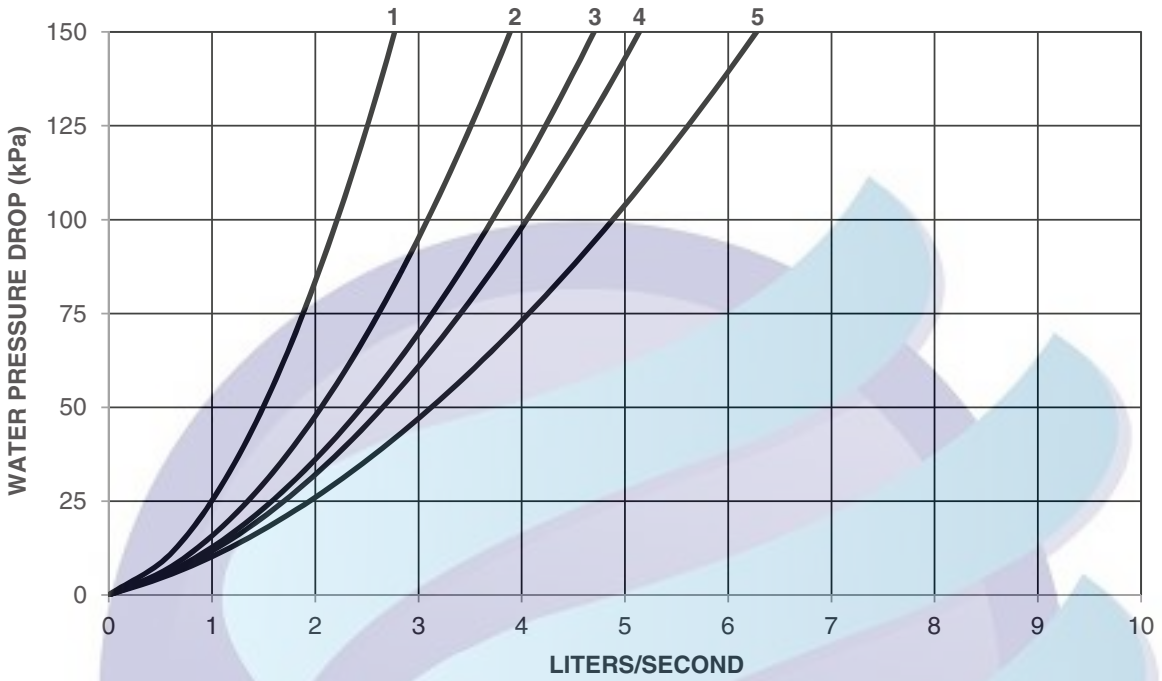

NOTES:

1. Pressure drop curves are suitable for water only.
2. Includes strainer and unit piping.

LEGEND

- | | | | |
|------------------|--------------|--------------|---------------|
| 1 — 30RAP011 | 4 — 30RAP025 | 7 — 30RAP035 | 10 — 30RAP050 |
| 2 — 30RAP016,018 | 5 — 30RAP030 | 8 — 30RAP040 | 11 — 30RAP055 |
| 3 — 30RAP020 | | 9 — 30RAP045 | 12 — 30RAP060 |

UNITS WITH DUAL PUMP HYDRONIC PACKAGE (cont)

APPENDIX A (cont)

Unit Pressure Drop Curves, 30RAP070-090 (English)

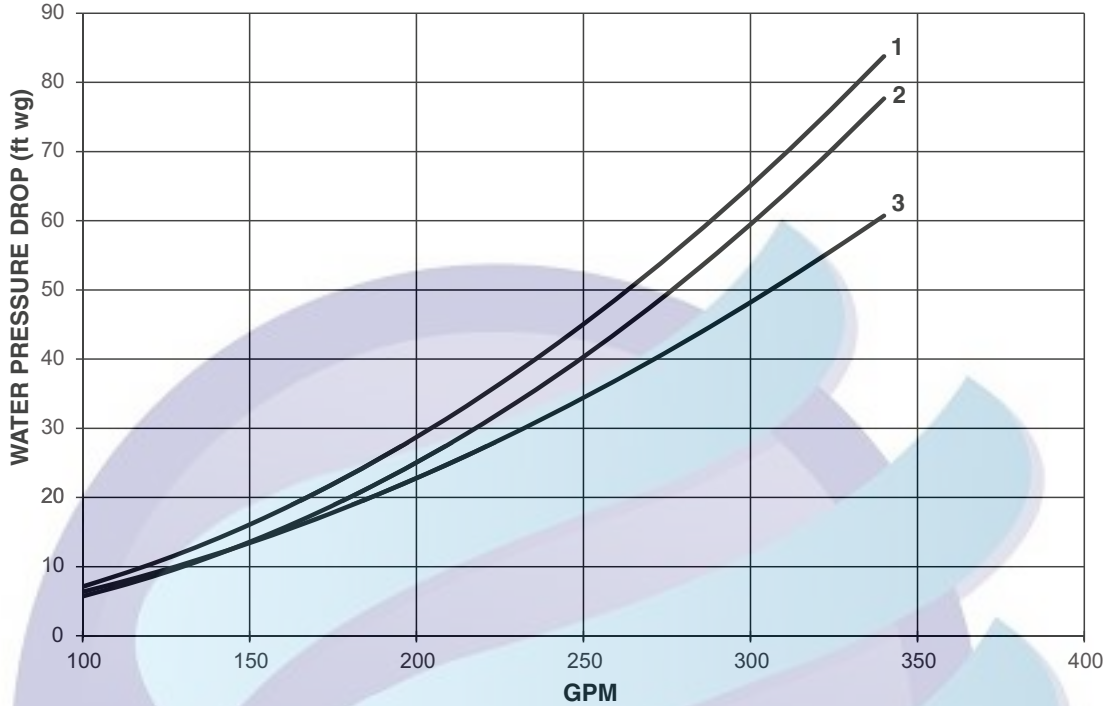

NOTES:

1. Use the following formula to convert feet of water to psig:
ft of water (.4335) = psig
2. Use the following formula to convert psig to feet of water:
psig (2.306) = ft of water
3. Pressure drop curves are suitable for water only.
4. Includes strainer and unit piping.

LEGEND

- 1 — 30RAP070
- 2 — 30RAP080
- 3 — 30RAP090

Unit Pressure Drop Curves, 30RAP070-090 (SI)

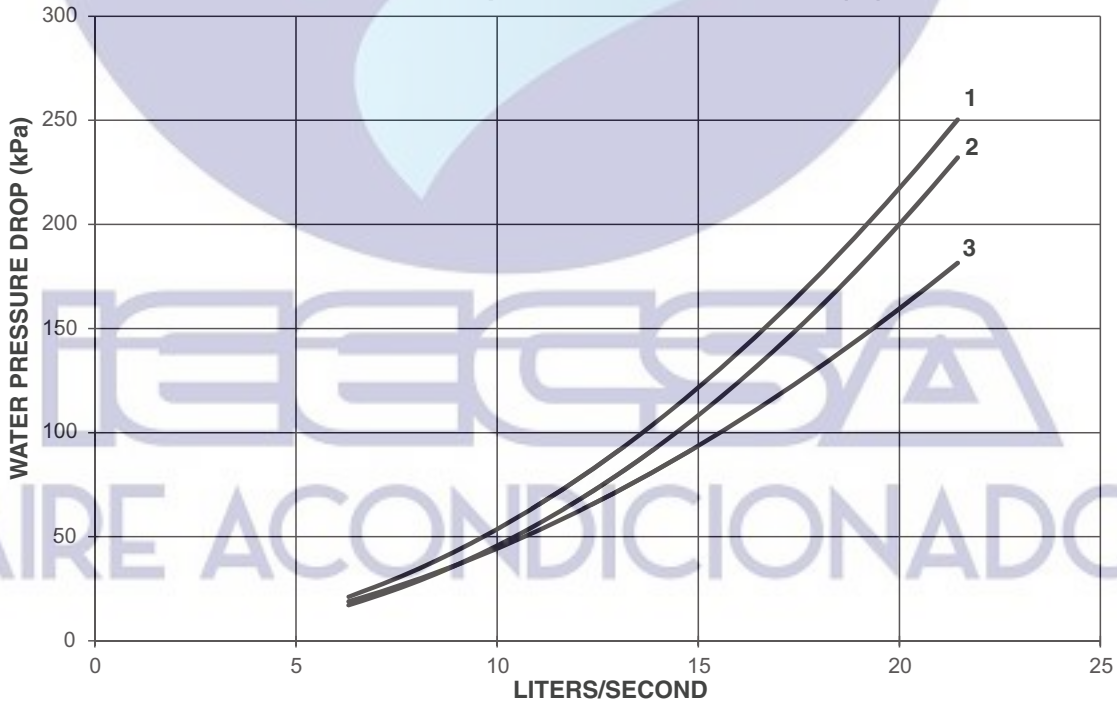

NOTES:

1. Pressure drop curves are suitable for water only.
2. Includes strainer and unit piping.

LEGEND

- 1 — 30RAP070
- 2 — 30RAP080
- 3 — 30RAP090

UNITS WITH DUAL PUMP HYDRONIC PACKAGE (cont)

APPENDIX A (cont)

Unit Pressure Drop Curves, 30RAP100-150 (English)

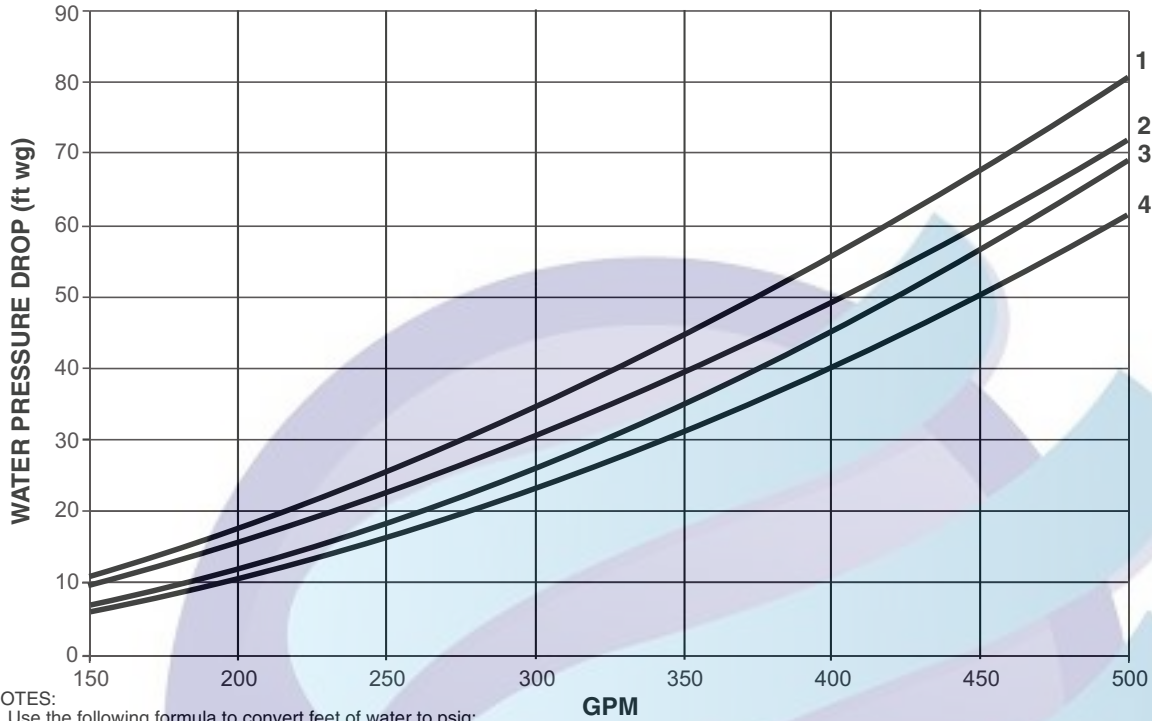

NOTES:

1. Use the following formula to convert feet of water to psig:
ft of water (.4335) = psig
2. Use the following formula to convert psig to feet of water:
psig (2.306) = ft of water
3. Pressure drop curves are suitable for water only.
4. Includes strainer and unit piping.

LEGEND

- 1 — 30RAP100
- 2 — 30RAP115
- 3 — 30RAP130
- 4 — 30RAP150

Unit Pressure Drop Curves, 30RAP100-150 (SI)



NOTES:

1. Pressure drop curves are suitable for water only.
2. Includes strainer and unit piping.

LEGEND

- 1 — 30RAP100
- 2 — 30RAP115
- 3 — 30RAP130
- 4 — 30RAP150

UNITS WITH DUAL PUMP HYDRONIC PACKAGE (cont)

APPENDIX A (cont)

Pressure Drop Curves, Accessory Storage Tanks

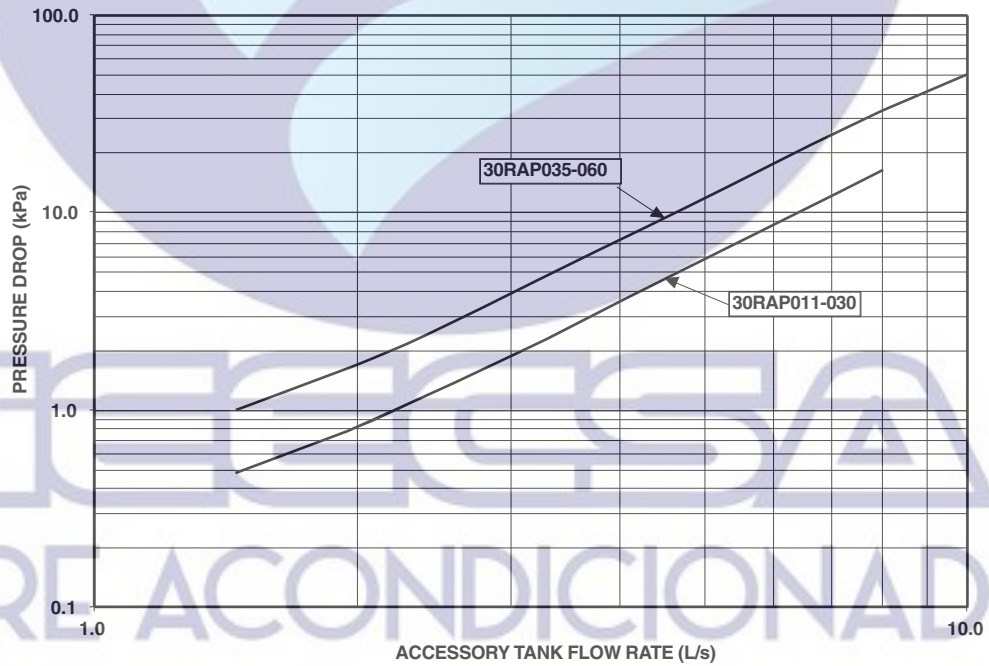
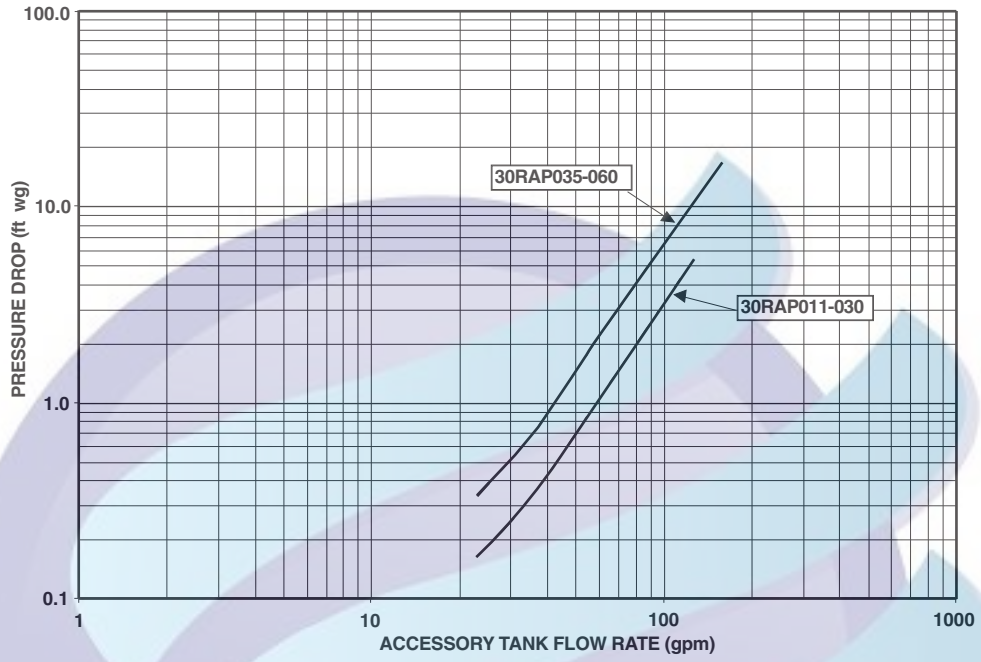



ICECSA
AIRE ACONDICIONADO