



Turn to the experts

## Product Data

WeatherExpert®

Gas Heat/Electric Cooling  
Packaged Rooftop Units

6 to 10 Nominal Tons



WeatherExpert™



48LC Sizes 07-12  
Packaged Rooftop Units with Gas Heat and Electric Cooling

Carrier's new Gas Heat / Electric Cooling WeatherExpert® 6 to 10 ton Commercial Package Rooftop models are designed to provide total low cost of ownership by providing some of the highest cooling efficiencies in the industry with low installed costs, low maintenance costs, and high reliability. These models focus on providing high IEERs (Integrated Energy Efficiency Ratios), which are a measurement of cooling part load performance and where actual buildings operate nearly all of the time. These high part load values are achieved by using logic that strategically sequences compressor stages, indoor fan motor, and condenser fan motor speeds. These models are in addition to the 3 to 5 ton models with SEERs up to 17.5 and 12.5 to 23 ton models with IEERs up to 19.1 to provide a full range offering.

### Ultra high efficiency

With IEERs up to 20.8, these new WeatherExpert models help to contribute in LEED credits and help qualify for rebates. The high IEER efficiencies are achieved by utilizing a proven staged compressor design on a single refrigerant circuit that provides three-stages of cooling capacity control. The indoor fan motors are high efficiency belt drive and controlled by a VFD (Variable Frequency Drive) that matches the cooling capacity stages for optimum comfort and efficient control.

Gas heat is provided with efficiencies up to 82% and two stages of operation to better match building loads. Models also have multiple heat capacities for

each size and use an induced draft combustion system.

### Easy to install

All WeatherExpert units have full perimeter base rails with built in rigging capability. They also are fully factory tested, refrigerant charged, and assembled at the factory for easy installation. Units are easily field-convertible to horizontal air flow, which makes it easy to adjust to unexpected job-site complications. Many factory options and field-installed accessories are also available that are pre-engineered and tested.

### Easy to maintain

Easy access door handles by Carrier provide quick access to all normally serviced components. Our "no-strip" screw system has superior holding power and guides screws into position while preventing the screw from stripping the unit's metal. Units come with accessible 2-inch filter that have a dedicated access door for easy replacement. Optional hinged panels allow easy access with pull tabs and quarter turn latches.

### Reliable

Carrier conducts rigorous testing to ensure your unit will perform as designed. Extensive rain testing is conducted in special designed test areas and under conditions that simulate actual job sites. In addition, units are both shake tested and driven around the country to make sure both the packaging and the unit components within hold up. Condensate pans are made of non corrosive composite material, motors are permanently

lubricated, and compressors use crankcase heaters, all to further strengthen the unit's reliability.

- Three-stage cooling capacity control with staged scroll compressors design. Each cooling stage is different in capacity output to better match typical building load profiles.
- Single refrigerant circuit design with precision sized TXV refrigerant metering devices to provide optimum operation through the entire operating range.
- Single full faced evaporator coil for full surface utilization, even at part load operation.
- Crankcase heater on each compressor designed to cycle off during the on cycle.
- IEER up to 20.8 and EERs up to 13.5.
- High efficiency permanently lubricated belt driven evaporator-fan motor with VFD (Variable Frequency Drive) controller.
- Electro-Mechanical Integrated Staging Control (ISC) board that provides:
  - Thermostat controls
  - Compressor staging
  - Indoor fan motor staging
  - Field and factory wiring connections
  - Outdoor fan motor staging
  - Crank case heater control
- Sound levels as low as 82 db.
- Exclusive non-corrosive composite condensate pan in accordance with ASHRAE 62 Standard, sloping design; side or bottom drain.

## Table of contents

Features/Benefits . . . . .	2
Model Number Nomenclature . . . . .	4
AHRI Capacity Ratings . . . . .	5
Physical Data . . . . .	7
Options and Accessories . . . . .	10
Dimensions . . . . .	14
Performance Data . . . . .	23
Fan Data . . . . .	40
Electrical Data . . . . .	48
Typical Wiring Diagrams . . . . .	54
Sequence of Operation . . . . .	62
Application Data . . . . .	67
Guide Specifications . . . . .	68

- Multiple gas heat sizes with heating efficiencies up to 82% and multi heat output per unit size.
- Induced draft combustion design.
- Redundant gas valve, with up to 2 stages of heating.
- Pre-painted exterior panels and primer-coated interior panels tested to 500 hours salt spray protection.
- Fully insulated with foil faced insulation throughout the entire air stream of the cabinet.
- Exclusive IGC solid-state control for on-board diagnostics with LED error code designation, burner control logic and energy saving indoor fan motor delay.
- High ambient cooling operation and ratings up to 125°F (52°C).
- Low ambient mechanical cooling operation down to 40°F (4°C). An economizer shall be the source of cooling in low ambient temperature conditions. When the outside air temperature is below 40°F (4°C), to reduce operating costs, mechanical cooling shall not be utilized.
- Access panels with easy grip handles.
- Innovative, easy starting, no-strip screw feature on unit access panels.
- Two-inch disposable return air filters.
- Tool-less filter access door.
- Field convertible airflow capability on all models. On 07 size, switch panels within the units. On 08 to 12 sizes, a simple field-installed supply duct kit is required.
- Provisions for thru-the-bottom power entry capability as standard.
- Single point gas and electric connections.
- Full perimeter base rail with built-in rigging adapters and fork truck slots.
- 24-volt control circuit protected with resettable circuit breaker.
- Totally enclosed high-efficiency ECM outdoor fan motor with permanently lubricated bearings.
- Low-pressure switch and high-pressure switch protection.
- Solid-state electronic direct spark ignition system.
- Flame roll-out safety protector.
- High capacity liquid line filter drier.
- Factory-installed Humid-MiZer® Adaptive Dehumidification System on all sizes
- Factory-installed SystemVu™ controller with LCD user display
- Standard Limited Parts Warranty: 10 yr. aluminized heat exchanger, 15 yr. stainless steel heat exchanger, 5 yr. compressor, 3 yr. SystemVu controller, 1 yr. parts.



Use of the AHRI Certified TM Mark indicates a manufacturer's participation in the program. For verification of certification for individual products, go to [www.ahridirectory.org](http://www.ahridirectory.org).

# Model number nomenclature



4 8 L C D 0 1 2 A 1 A 5 - 0 A 0 A 0

### Unit Heat Type

48 – Gas Heat Packaged Rooftop

### Model Series – WeatherExpert

LC – Ultra High Efficiency

### Heat Size

D = Low Gas Heat  
 E = Medium Gas Heat  
 F = High Gas Heat  
 S = Low Heat with Stainless Steel Exchanger  
 R = Medium Heat with Stainless Steel Exchanger  
 T = High Heat with Stainless Steel Exchanger

### Refrig. Systems Options

0 = Three stage cooling capacity control with TXV  
 A = Three stage cooling capacity control with TXV and Humidi-MiZer® System

### Cooling Tons

07 – 6 ton  
 08 – 7.5 ton  
 09 – 8.5 ton  
 12 – 10 ton

### Sensor Options

A = None  
 B = RA Smoke Detector  
 C = SA Smoke Detector  
 D = RA and SA Smoke Detector  
 E = CO<sub>2</sub>  
 F = RA Smoke Detector and CO<sub>2</sub>  
 G = SA Smoke Detector and CO<sub>2</sub>  
 H = RA and SA Smoke Detector and CO<sub>2</sub>  
 J = Condensate Overflow Switch  
 K = Condensate Overflow Switch and RA Smoke Detectors  
 L = Condensate Overflow Switch and RA and SA Smoke Detectors

### Indoor Fan Motor Options

1 = Standard Static Belt Drive with VFD controller  
 2 = Medium Static Belt Drive with VFD controller  
 3 = High Static Belt Drive with VFD controller  
 4 = Ultra High Static Belt Drive with VFD controller (sizes 08, 09 only)

### Brand / Packaging

0 = Standard  
 1 = LTL

### Electrical Options

A = None  
 B = HACR Breaker  
 C = Non-Fused Disconnect  
 D = Thru-the-Base Connections  
 E = HACR Breaker with Thru-the-Base Connections  
 F = Non-Fused Disconnect and Thru-the-Base Connections

### Service Options

0 = None  
 1 = Unpowered Convenience Outlet  
 2 = Powered Convenience Outlet  
 3 = Hinged Panels  
 4 = Hinged Panels, Unpowered Convenience Outlet  
 5 = Hinged Panels, Powered Convenience Outlet

### Intake / Exhaust Options

A = None  
 B = Low Leak, Temperature Economizer with Barometric Relief  
 E = Low Leak, Enthalpy Economizer with Barometric Relief  
 N = Ultra Low Leak, Temperature Economizer with Barometric Relief  
 R = Ultra Low Leak, Enthalpy Economizer with Barometric Relief

### Base unit controls

0 = Electromechanical Controls  
 1 = RTU Open Multi-Protocol Controller  
 4 = SystemVu™ Controller

### Design Revision

– Factory Design Revision

### Voltage

1 = 575/3/60  
 5 = 208-230/3/60  
 6 = 460/3/60

### Coil Options (Outdoor – Indoor – Hail Guard)

A = Al/Cu – Al/Cu  
 B = Precoat Al/Cu – Al/Cu  
 C = E-coat Al/Cu – Al/Cu  
 D = E-coat Al/Cu – E-coat Al/Cu  
 E = Cu/Cu – Al/Cu  
 F = Cu/Cu – Cu/Cu  
 M = Al/Cu – Al/Cu – Louvered Hail Guard  
 N = Precoat Al/Cu – Al/Cu – Louvered Hail Guard  
 P = E-coat Al/Cu – Al/Cu – Louvered Hail Guard  
 Q = E-coat Al/Cu – E-coat Al/Cu – Louvered Hail Guard  
 R = Cu/Cu – Al/Cu – Louvered Hail Guard  
 S = Cu/Cu – Cu/Cu – Louvered Hail Guard

### AHRI COOLING RATING TABLE FOR 208V UNITS

48LC UNIT	COOLING STAGES	MOTOR OPTION	NOMINAL CAPACITY	NOMINAL COOLING CAPACITY	TOTAL POWER (kW)	EER	SEER / IEER	RATED INDOOR AIRFLOW (CFM)
007	3	—	6.0	70.0	5.4	13.0	20.5	2,250
008	3	1	7.5	89.0	6.8	13.0	19.8	2,625
		2	7.5	89.0	7.0	12.8	19.4	2,625
		3	7.5	89.0	7.0	12.8	19.4	2,625
		4	7.5	89.0	7.0	12.8	19.3	2,625
009	3	—	8.5	101.0	7.7	13.5	20.8	2,970
012	3	—	10.0	116.0	8.9	13.0	20.6	3,500

### AHRI COOLING RATING TABLE FOR 230/460/575V UNITS

48LC UNIT	COOLING STAGES	MOTOR OPTION	NOMINAL CAPACITY	NOMINAL COOLING CAPACITY	TOTAL POWER (kW)	EER	SEER / IEER	RATED INDOOR AIRFLOW (CFM)
007	3	—	6.0	70.0	5.4	13.0	20.3	2,250
008	3	1	7.5	89.0	6.8	13.0	19.4	2,625
		2	7.5	89.0	7.0	12.8	19.0	2,625
		3	7.5	89.0	7.0	12.8	19.0	2,625
		4	7.5	89.0	7.0	12.8	18.9	2,625
009	3	—	8.5	101.0	7.7	13.2	19.8	2,970
012	3	—	10.0	116.0	8.9	13.0	20.3	3,500

**LEGEND**

- AHRI** — Air Conditioning, Heating, and Refrigeration Institute Test Standard
- ASHRAE** — American Society of Heating, Refrigerating, and Air Conditioning, Inc.
- EER** — Energy Efficiency Ratio
- SEER** — Seasonal Energy Efficiency Ratio

**NOTES:**

1. Rated in accordance with AHRI Standards 340/360.
2. Ratings are based on:  
Cooling Standard: 80°F (27°C) db, 67°F (19°C) wb indoor air temp and 95°F (35°C) db outdoor air temp.
3. 48LC units comply with US Energy Policy Act. To evaluate code compliance requirements, refer to state and local codes.

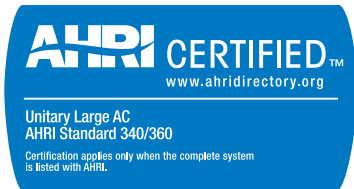

### COOLING MINIMUM - MAXIMUM AIRFLOW RATINGS

48LC SIZE	COOLING STAGE	MAX CFM	MIN CFM	MAX OD AMBIENT TEMP (°F)	MIN OD AMBIENT TEMP (°F)
007	Stage-3	3000	1500	125	40
	Stage-2	2000	1000		
	Stage-1	2000	1000		
008	Stage-3	3750	1900	125	40
	Stage-2	2500	1250		
	Stage-1	2500	1250		
009	Stage-3	4250	2150	125	40
	Stage-2	2800	1400		
	Stage-1	2800	1400		
012	Stage-3	5000	2500	125	40
	Stage-2	3000	1500		
	Stage-1	2000	1000		

NOTE: SystemVu™ controller provides cooling operation down to 0°F (-18°C).

## HEAT RATING - NATURAL GAS AND PROPANE

48LC UNITS	GAS TYPE	GAS HEAT	AL/SS HEAT EXCHANGER		TEMP RISE (°F)	THERMAL EFFICIENCY (%)
			INPUT/OUTPUT STAGE 1 (MBH)	INPUT/OUTPUT STAGE 2 (MBH)		
07	Natural Gas	Low	50 / 41	72 / 59	15 - 55	82
		Med	90 / 73	125 / 103	20 - 50	82
		High	120 / 98	180 / 148	35 - 65	82
08		Low	120 / 96	150 / 120	15 - 60	80
		Med	144 / 118	180 / 146	20 - 55	81
		High	192 / 156	240 / 195	25 - 60	81
09		Low	120 / 96	150 / 120	15 - 60	80
		Med	144 / 118	180 / 146	20 - 55	81
		High	192 / 156	240 / 195	25 - 60	81
12		Low	144 / 118	180 / 146	20 - 55	81
		Med	192 / 156	240 / 195	25 - 60	81
		High	252 / 202	315 / 252	20 - 65	80
	*Propane	High	202 / 164	252 / 204	20 - 65	81

\* Not required on unit rating plate.

### NOTES:

- Heat ratings are for natural gas heat exchangers operated at or below 2000 ft (610 m). For information on propane or altitudes above 2000 ft (610 m), see the Application Data section of this book. Accessory Propane/High Altitude kits are also available.
- In the USA the input rating for altitudes above 2000 ft (610 m) must be derated by 4% for each 1000 ft (305 m) above sea level.

## HEATING MINIMUM - MAXIMUM CFM (NATURAL GAS AND PROPANE)

48LC SIZE	HEAT SIZE	MIN CFM	MAX CFM
007	LOW	1500	3000
	MED	1900	3000
	HIGH	2100	3000
008	LOW	1900	3750
	MED	2450	3750
	HIGH	3000	3750
009	LOW	2150	4250
	MED	2450	4250
	HIGH	3000	4250
012	LOW	2500	5000
	MED	3000	5000
	HIGH - NG	3590	5000
	HIGH - LP	2910	5000

### LEGEND

NG — Natural Gas  
LP — Liquid Propane

## SOUND PERFORMANCE

UNIT	COOLING STAGES	OUTDOOR SOUND (dB) AT 60 Hz								
		A-Weighted	63	125	250	500	1000	2000	4000	8000
007	3	82	88.6	85.0	81.6	79.5	77.4	74.1	71.0	66.3
008	3	83	89.3	86.0	82.9	80.7	78.5	73.6	69.6	64.5
009	3	83	89.3	86.0	82.9	80.7	78.5	73.6	69.6	64.5
012	3	83	89.3	86.0	82.9	80.7	78.5	73.6	69.6	64.5

### LEGEND

dB — Decibel

### NOTES:

- Outdoor sound data is measured in accordance with AHRI standard 270.
- Measurements are expressed in terms of sound power. Do not compare these values to sound pressure values because sound

pressure depends on specific environmental factors which normally do not match individual applications. Sound power values are independent of the environment and therefore more accurate.

- A-weighted sound ratings filter out very high and very low frequencies, to better approximate the response of "average" human ear. A-weighted measurements for Carrier units are taken in accordance with AHRI standard 270.

## PHYSICAL DATA (COOLING) 6 TO 10 TONS

		48LC*007	48LC*008	48LC*009	48LC*012
<b>Refrigeration System</b>					
	# Circuits / # Comp. / Type	1 / 2 / Scroll	1 / 2 / Scroll	1 / 2 / Scroll	1 / 2 / Scroll
	RTPF models R-410A charge A/B (lbs-oz)	15 - 8	22 - 5	25-11	24-15
	Humidi-MiZer R-410A charge A/B (lbs-oz)	23-5	27-6	34-0	31-8
	oil A/B (oz)	25 / 42	42 / 42	42 / 42	42 / 42
	Metering Device	TXV	TXV	TXV	TXV
	High-press. Trip / Reset (psig)	630 / 505	630 / 505	630 / 505	630 / 505
	Low-press. Trip / Reset (psig)	—	—	54/117	54/117
	Loss of charge Trip/Reset (psig)	27 / 44	27 / 44	—	—
<b>Evaporator Coil</b>					
	Material (Tube/Fin)	Cu / Al	Cu / Al	Cu / Al	Cu / Al
	Coil Type	<sup>5</sup> / <sub>16</sub> -in. RTPF	<sup>5</sup> / <sub>16</sub> -in. RTPF	<sup>5</sup> / <sub>16</sub> -in. RTPF	<sup>5</sup> / <sub>16</sub> -in. RTPF
	Coil Length (in.)	40	52.5	52.5	52.5
	Coil Height (in.)	40	48	48	48
	Rows / FPI	4 / 15	4 / 15	4 / 15	4 / 15
	Total Face Area (ft <sup>2</sup> )	11.1	17.5	17.5	17.5
	Condensate Drain Conn. Size	<sup>3</sup> / <sub>4</sub> -in.	<sup>3</sup> / <sub>4</sub> -in.	<sup>3</sup> / <sub>4</sub> -in.	<sup>3</sup> / <sub>4</sub> -in.
<b>Humidi-MiZer® Coil</b>					
	Material	Cu / Al	Cu / Al	Cu / Al	Cu / Al
	Coil Type	<sup>5</sup> / <sub>16</sub> -in. RTPF	<sup>5</sup> / <sub>16</sub> -in. RTPF	<sup>5</sup> / <sub>16</sub> -in. RTPF	<sup>5</sup> / <sub>16</sub> -in. RTPF
	Coil Length (in.)	38	49.5	49.5	49.5
	Coil Height (in.)	32	40	40	40
	Rows / FPI	2 / 18	1 / 18	1 / 18	1 / 18
	Total Face Area (ft <sup>2</sup> )	8.4	13.8	13.8	13.8
<b>Evap. Fan and Motor</b>					
<b>STANDARD STATIC 3 PHASE</b>	Motor Qty / Drive Type	1 / Belt	1 / Belt	1 / Belt	1 / Belt
	Max BHP	1.7	1.7	1.7	2.4
	RPM Range	421-631	375-563	375-563	421-631
	Motor Frame Size	56	56	56	56Z
	Fan Qty / Type	1 / Centrifugal	1 / Centrifugal	1 / Centrifugal	1 / Centrifugal
	Fan Diameter (in.)	15.5 x 15	18.5 x 18	18.5 x 18	18.5 X 18
<b>MEDIUM STATIC 3 PHASE</b>	Motor Qty / Drive Type	1 / Belt	1 / Belt	1 / Belt	1 / Belt
	Max BHP	1.7	2.4	2.4	3.7
	RPM Range	605-908	547-757	547-757	631-841
	Motor Frame Size	56	56Z	56Z	56HZ
	Fan Qty / Type	1 / Centrifugal	1 / Centrifugal	1 / Centrifugal	1 / Centrifugal
	Fan Diameter (in.)	15.5 x 15	18.5 x 18	18.5 x 18	18.5 X 18
<b>HIGH STATIC 3 PHASE</b>	Motor Qty / Drive Type	1 / Belt	1 / Belt	1 / Belt	1 / Belt
	Max BHP	2.9	3.7	3.7	4.9
	RPM Range	847-1150	710-879	710-879	832-1021
	Motor Frame Size	56	145TZ	145TZ	145TZ
	Fan Qty / Type	1 / Centrifugal	1 / Centrifugal	1 / Centrifugal	1 / Centrifugal
	Fan Diameter (in.)	15.5 x 15	18.5 x 18	18.5 x 18	18.5 X 18
<b>ULTRA HIGH STATIC 3 PHASE</b>	Motor Qty / Drive Type	—	1 / Belt	1 / Belt	—
	Max BHP (208/230/460/575v)	—	4.9	4.9	—
	RPM Range	—	832-1021	832-1021	—
	Motor Frame Size	—	145TZ	145TZ	—
	Fan Qty / Type	—	1 / Centrifugal	1 / Centrifugal	—
	Fan Diameter (in.)	—	18.5 x 18	18.5 x 18	—

## PHYSICAL DATA (COOLING) 6 TO 10 TONS (cont)

	48LC*007	48LC*008	48LC*009	48LC*012
<b>Cond. Coil 1</b>				
Material	Cu / Al	Cu / Al	Cu / Al	Cu / Al
Coil Type	<sup>5</sup> / <sub>16</sub> -in. RTPF	<sup>5</sup> / <sub>16</sub> -in. RTPF	<sup>5</sup> / <sub>16</sub> -in. RTPF	<sup>5</sup> / <sub>16</sub> -in. RTPF
Coil Length (in.)	82	100	64	64
Coil Height (in.)	44	52	52	52
Rows / FPI	2 / 18	2 / 18	2/18	2/18
Total Face Area (ft <sup>2</sup> )	25.1	36.1	23.1	23.1
<b>Cond. Coil 2</b>				
Material	—	—	Cu / Al	Cu / Al
Coil Type	—	—	<sup>5</sup> / <sub>16</sub> -in. RTPF	<sup>5</sup> / <sub>16</sub> -in. RTPF
Coil Length (in.)	—	—	64	64
Coil Height (in.)	—	—	52	52
Rows / FPI	—	—	2/18	2/18
Total Face Area (ft <sup>2</sup> )	—	—	23.1	23.1
<b>Cond. fan / motor</b>				
Qty / Motor Drive Type	2 / direct	3 / direct	3 / direct	3 / direct
Motor HP / RPM	<sup>1</sup> / <sub>3</sub> / 1000	<sup>1</sup> / <sub>3</sub> / 1000	<sup>1</sup> / <sub>3</sub> / 1000	<sup>1</sup> / <sub>3</sub> / 1000
Fan diameter (in.)	22	22	22	22
<b>Filters</b>				
RA Filter # / Size (in.)	4 / 20 x 20 x 2	6 / 18 x 24 x 2	6 / 18 x 24 x 2	6 / 18 x 24 x 2
OA inlet screen # / Size (in.)	V 2 / 24 x 27 x 1 H 1 / 30 x 39 x1	V 2 / 24 x 27 x 1 H 1 / 30 x 39 x1	V 2 / 24 x 27 x 1 H 1 / 30 x 39 x2	V 2 / 24 x 27 x 1 H 1 / 30 x 39 x2





### PHYSICAL DATA (HEATING) 6 TO 10 TONS

Gas Connection		48LC**07	48LC**08	48LC**09	48LC**12
		# of Gas valves	1	1	1
Nat. gas supply line pressure (in. wg) / (PSIG)		4 -13 / 0.18 - 0.47	4 -13 / 0.18 - 0.47	4 -13 / 0.18 - 0.47	4 -13 / 0.18 - 0.47
LP gas supply line pressure (in. wg) / (PSIG)		11 -13 / 0.40 - 0.47	11 -13 / 0.40 - 0.47	11 -13 / 0.40 - 0.47	11 -13 / 0.40 - 0.47
Heat Anticipator Setting (amps)					
First stage		0.14	0.14	0.14	0.14
Second stage		0.14	0.14	0.14	0.14
Natural Gas Heat					
LOW	# of stages / # of burners (total)	1 or 2 / 2	1 or 2 / 5	1 or 2 / 5	1 or 2 / 6
	Connection size	1/2-in. NPT	3/4-in. NPT	3/4-in. NPT	3/4-in. NPT
	Rollout switch opens/closes (°F)	195 / 115	225 / 175	225 / 175	225 / 175
	Temperature rise (°F)	15 - 55	15 - 60	15 - 60	20 - 55
MED	# of stages / # of burners (total)	1 or 2 / 3	1 or 2 / 6	1 or 2 / 6	1 or 2 / 8
	Connection size	1/2-in. NPT	3/4-in. NPT	3/4-in. NPT	3/4-in. NPT
	Rollout switch opens/closes (°F)	195 / 115	225 / 175	225 / 175	225 / 175
	Temperature rise (°F)	20 - 50	20 - 55	20 - 55	25 - 60
HIGH	# of stages / # of burners (total)	1 or 2 / 4	1 or 2 / 8	1 or 2 / 8	1 or 2 / 9
	Connection size	3/4-in. NPT	3/4-in. NPT	3/4-in. NPT	3/4-in. NPT
	Rollout switch opens/closes (°F)	195 / 115	225 / 175	225 / 175	225 / 175
	Temperature rise (°F)	35 - 65	25 - 60	25 - 60	20 - 65
Liquid Propane Heat					
LOW	# of stages / # of burners (total)	1 or 2 / 2	1 or 2 / 5	1 or 2 / 5	1 or 2 / 6
	Connection size	1/2-in. NPT	3/4-in. NPT	3/4-in. NPT	3/4-in. NPT
	Rollout switch opens/closes (°F)	195 / 115	225 / 175	225 / 175	225 / 175
	Temperature rise (°F)	15 - 55	15 - 60	15 - 60	20 - 55
MED	# of stages / # of burners (total)	1 or 2 / 3	1 or 2 / 6	1 or 2 / 6	1 or 2 / 8
	Connection size	1/2-in. NPT	3/4-in. NPT	3/4-in. NPT	3/4-in. NPT
	Rollout switch opens/closes (°F)	195 / 115	225 / 175	225 / 175	225 / 175
	Temperature rise (°F)	20 - 50	20 - 55	20 - 55	25 - 60
HIGH	# of stages / # of burners (total)	1 or 2 / 4	1 or 2 / 8	1 or 2 / 8	1 or 2 / 9
	Connection size	3/4-in. NPT	3/4-in. NPT	3/4-in. NPT	3/4-in. NPT
	Rollout switch opens/closes (°F)	195 / 115	225 / 175	225 / 175	225 / 175
	Temperature rise (°F)	35 - 65	25 - 60	25 - 60	20 - 65

## FACTORY-INSTALLED OPTIONS AND FIELD-INSTALLED ACCESSORIES

CATEGORY	ITEM	FACTORY-INSTALLED OPTION	FIELD-INSTALLED ACCESSORY
Cabinet	Thru-the-base electrical or gas-line connections	X	X
	Hinged access panels	X	
Coil Options	Cu/Cu indoor and/or outdoor coils	X	
	Pre-coated outdoor coils	X	
	Premium, E-coated outdoor coils	X	
Condenser Protection	Condenser coil hail guard (louvered design)	X	X
Humidity Control	Humidi-MiZer® Adaptive Dehumidification System	X	
Controls	Thermostats, temperature sensors, and subbases		X
	Smoke detector (supply and/or return air)	X	
	Horn/Strobe Annunciator <sup>1</sup>		X
	Time Guard II compressor delay control circuit		X
	Phase Monitor		X
	SystemVu™ Controller <sup>2</sup>	X	
Economizers and Outdoor Air Dampers	EconoMi\$er X for electromechanical controls, complies with FDD. (Low Leak and Ultra Low Leak air damper models) <sup>3</sup>	X	X
	EconoMi\$er2 for DDC controls, complies with FDD. (Low Leak and Ultra Low Leak air damper models) <sup>3</sup>	X	X
	Barometric relief <sup>4</sup>	X	X
	Power exhaust		X
Economizer Sensors and IAQ Devices	Single dry bulb temperature sensors <sup>5</sup>	X	X
	Differential dry bulb temperature sensors <sup>5</sup>		X
	Single enthalpy sensors <sup>5</sup>	X	X
	Differential enthalpy sensors <sup>5</sup>		X
	Wall or duct mounted CO <sub>2</sub> sensor <sup>5</sup>		X
	Unit mounted CO <sub>2</sub> sensor <sup>5</sup>	X	
Gas Heat	Propane conversion kit		X
	Stainless steel heat exchanger	X	
	High altitude conversion kit		X
	Flue Shield (07 size)		X
	Flue Discharge Deflector		X
Indoor Motor and Drive	Multiple motor and drive packages	X	
Power Options	Convenience outlet (powered)	X	
	Convenience outlet (unpowered)	X	
	HACR circuit breaker <sup>6,7</sup>	X	
	Non-fused disconnect <sup>7</sup>	X	
Roof Curbs	Roof curb 14-in. (356 mm)		X
	Roof curb 24-in. (610 mm)		X

### NOTES:

- Requires a field-supplied 24v transformer for each application. See price pages for details.
- SystemVu controller is not available on units equipped with Low Leak Economizers.
- FDD (Fault Detection and Diagnostic) capability per California Title 24 section 120.2.
- Included with economizer.
- Sensors used to optimize economizer performance.
- On 575v applications, HACR breaker can only be used with WYE power distribution systems. Using on Delta power distribution systems is prohibited.
- When selecting a factory-installed HACR breaker or non-fused disconnect, note they are sized for the unit as ordered from the factory. The sizing of these do not accommodate any field items such as power exhaust devices etc.

## Factory-installed accessories

### Economizer

Economizers can reduce operating costs. They bring in fresh, outside air for ventilation; and provide cool outside air to cool your building. This also is the preferred method of low ambient cooling. When coupled to CO<sub>2</sub> sensors, economizers can limit the ventilation air to only that amount required.

Economizers are available, installed and tested by the factory, with either enthalpy or temperature dry-bulb inputs. There are also models for electromechanical and direct digital controllers. Additional sensors are available as accessories to optimize the economizer.

Economizers include gravity-controlled barometric relief that helps equalize building pressure and ambient air pressures. This can be a cost effective solution to prevent building pressurization. Economizers are available in ultra low leak and low leak versions.

### CO<sub>2</sub> Sensor

The CO<sub>2</sub> sensor works with the economizer to intake only the correct amount of outside air for ventilation. As occupants fill your building, the CO<sub>2</sub> sensor detects their presence through increasing CO<sub>2</sub> levels, and opens the economizer appropriately.

When the occupants leave, the CO<sub>2</sub> levels decrease, and the sensor appropriately closes the economizer. This intelligent control of the ventilation air, called Demand Controlled Ventilation (DCV), reduces the overall load on the rooftop, saving money.

### Smoke Detectors

Trust the experts. Smoke detectors make your application safer and your job easier. Carrier smoke detectors immediately shut down the rooftop unit when smoke is detected. They are available, installed by the factory, for supply air, return air, or both.

### Louvered Hail Guards

Sleek, louvered panels protect the condenser coil from hail damage, foreign objects, and incidental contact.

### Convenience Outlet (powered or un-powered)

Reduce service and/or installation costs by including a convenience outlet in your specification. Carrier will install this service feature at our factory. Provides a convenient, 15 amp, 115v GFCI receptacle with "Wet in Use" cover. The "powered" option allows the installer to power the outlet from the line side of the disconnect or load side as required by code. The "unpowered" option is to be powered from a separate 115/120v power source.

### Non-fused Disconnect

This OSHA-compliant, factory-installed, safety switch allows a service technician to locally secure power to the rooftop. When selecting a factory-installed non-fused disconnect, note they are sized for the unit as ordered from the factory. The sizing of these do not accommodate field items such as power exhaust devices, etc.

### Hinged Access Panels

Allows access to unit's major components with specifically designed hinged access panels. Panels are: filter, control

box, fan motor and compressor. Comes with quarter turn latches and lift tabs.

### Optional Stainless Steel Heat Exchanger

The stainless steel heat exchanger option provides the tubular heat exchanger be made out of a minimum 20 gage type 409 stainless steel for applications where the mixed air to the heat exchanger is expected to drop below 45°F (7°C). Stainless steel may be specified on applications where the presence of airborne contaminants require its use (applications such as paper mills) or in area with very high outdoor humidity that may result in severe condensation in the heat exchanger during cooling operation.

### Flue Discharge Heat Shield

The flue discharge heat shield keeps people from touching the rooftop unit's potentially hot flue discharge. This is especially useful for ground level applications, where more untrained people could have access to the unit's exterior (07 size models only).

### HACR Breaker

These manual reset devices provide overload and short circuit protection for the unit. Factory wired and mounted with the units with access cover to help provide environment protection.

When selecting a factory-installed HACR breaker, note they are sized for the unit as ordered from the factory. The sizing of these do not accommodate any field items such as power exhaust devices etc.

On 575v applications, HACR breaker can only be used with WYE power distribution systems. Use on Delta power distribution systems is prohibited.

### Optional Humidi-MiZer® Adaptive Dehumidification System

Carrier's Humidi-MiZer adaptive dehumidification system is an all-inclusive factory-installed option that can be ordered with any 48LC WeatherExpert® rooftop unit.

This system expands the envelope of operation of Carrier's WeatherExpert rooftop products to provide unprecedented flexibility to meet year round comfort conditions.

The Humidi-MiZer adaptive dehumidification system has a unique dual operational mode setting. The Humidi-MiZer system provides greater dehumidification of the occupied space by two modes of dehumidification operations in addition to its normal design cooling mode.

The 48LC WeatherExpert rooftop coupled with the Humidi-MiZer system is capable of operating in normal design cooling mode, subcooling mode, and hot gas reheat mode. Normal design cooling mode is when the unit will operate under its normal sequence of operation by cycling compressors to maintain comfort conditions.

Subcooling mode will operate to satisfy part load type conditions when the space requires combined sensible and a higher proportion of latent load control. Hot Gas Reheat mode will operate when outdoor temperatures diminish and the need for latent capacity is required for sole humidity control. Hot Gas Reheat mode will provide neutral air for maximum dehumidification operation.

## Alternate Motors and Drives

Some applications need larger horsepower motors, some need more airflow, and some need both. Regardless of the case, your Carrier expert has a factory-installed combination to meet your application. A wide selection of motors and pulleys (drives) are available, factory-installed, to handle nearly any application.

## Thru-the-Base Connections

Thru-the-base connections, available as either an accessory or as a factory option, are necessary to ensure proper connection and seal when routing wire and piping through the rooftop's basepan and curb. These couplings eliminate roof penetration and should be considered for gas lines, main power lines, as well as control power.

## Thermostat

Due to the three-stage cooling capacity design of these units, a three-stage cooling thermostat is required for the unit to perform at listed operating efficiencies.

Carrier offers a Honeywell branded T7350D (3 Cool/3 Heat) Commercial Programmable Thermostat.

This provides:

- 7-day programmable
- 65-day clock with holiday programming
- Automatic Daylight Saving Time adjustment
- Backlit display
- Changeover selections: automatic or manual
- Fan configurable: continuous or intermittent during occupied

## SystemVu Controller

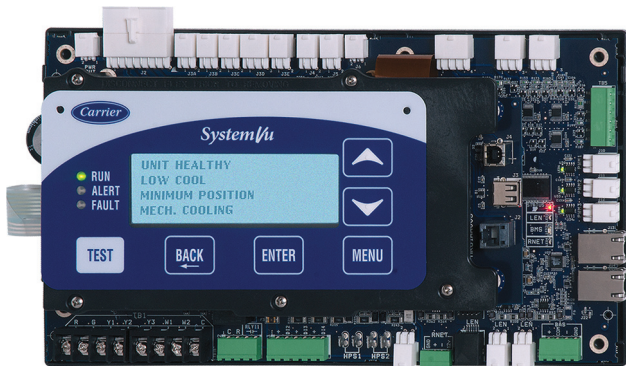

BACnet is a registered trademark of ASHRAE. ASHRAE does not endorse, approve or test products for compliance with ASHRAE standards. Compliance of listed products to the requirements of ASHRAE Standard 135 is the responsibility of BACnet International (BI). BTL is a registered trademark of BI.

Carrier's new SystemVu unit controller is an optional factory-installed and tested controller designed specifically for use in the WeatherExpert rooftop units.

This new controller takes on a whole new approach to provide an intuitive, intelligent controller that not only monitors and controls the unit, but also provides linkage to multiple building automation systems.

Each SystemVu controller makes it easy to set up, service, troubleshoot, gain historical data, generate reports and provide comfort only Carrier is noted for.

Some of the key features include:

- Easy to read back-lit four line text screen for superior visibility.
- Quick operational condition LEDs of: Run, Alert, and Fault.
- Simple navigation with large keypad buttons of: Navigation arrows, Test, Back, Enter and Menu.
- Capable of being controlled with a conventional thermostat, space sensor or building automation systems.
- Service Capabilities Include:
  - Auto run test
  - Manual run test
  - Component run hours and starts
  - Commissioning reports
  - Data logging
- Full Range of Diagnosis:
  - Read refrigerant pressures without the need of gages
  - Sensor faults
  - Compressor reverse rotation
  - Economizer diagnostics that meets California Title 24 requirements
- Quick data transfer via USB port:
  - Unit configuration uploading/downloading
  - Data logging
  - Software upgrades
- Built in capability for:
  - i-Vu® open systems
  - BACnet<sup>1</sup> systems
  - CCN systems
- Configuration and alarms point capability:
  - Contain over 100 alarm codes
  - Contain over 260 status, troubleshooting, diagnostic and maintenance points
  - Contain over 270 control configuration setpoints

NOTE: SystemVu controller is not available on units equipped with Low Leak Economizers.

1. BACnet is a registered trademark of ASHRAE (American Society of Heating, Refrigerating and Air-Conditioning Engineers).



## Field-installed options

### Propane Heating

Convert your gas heat rooftop from standard natural gas operation to propane using this field-installed kit.

### High Altitude Heating

High altitudes have less oxygen, which means heat exchangers need less fuel. The new gas orifices in this field-installed kit make the necessary adjustment for high altitude applications. They restore the optimal fuel to air mixture and maintain healthy combustion at altitudes above 2000 ft (610 m). Kits may not be required in all areas.

### Flue Discharge Deflector

The flue discharge deflector is a useful accessory when flue gas recirculation is a concern. By venting the flue discharge

upwards, the deflector minimizes the chance for a neighboring unit to intake the flue exhaust.

### Power Exhaust

Superior internal building pressure control. This field-installed accessory may eliminate the need for costly, external pressure control fans.

### Time Guard II Control Circuit

This accessory protects your compressor by preventing short-cycling in the event of some other failure, prevents the compressor from restarting for 30 seconds after stopping. Not required if built into thermostat or building management system.

## OPTION AND ACCESSORY WEIGHTS

OPTION/ACCESSORY	WEIGHTS IN LBS			
	48LC**07	48LC**08	48LC**09	48LC**12
Humidi-MiZer®	80	90	90	90
Medium Gas Heat	15	28	28	28
High Gas Heat	29	50	50	50
Medium Heat w/ Stainless Steel Exchanger	15	28	28	28
High Heat w/ Stainless Steel Exchanger	29	50	50	50
Return Smoke Detector	5	5	5	5
Supply Smoke Detector	5	5	5	5
RA and SA Smoke Detector	10	10	10	10
CO <sub>2</sub> Sensor	5	5	5	5
RA Smoke Detector and CO <sub>2</sub>	10	10	10	10
SA Smoke Detector and CO <sub>2</sub>	10	10	10	10
RA and SA Smoke Detector and CO <sub>2</sub>	15	15	15	15
Medium Static Belt Drive	15	45	45	45
High Static Belt Drive	15	45	45	45
Cu/Cu Cond and Al/Cu Evap	23	25	25	25
Cu/Cu Cond and Cu/Cu Evap	49	47	47	47
Al/Cu Cond and Al/Cu Evap + Hail Guard	34	45	45	45
Pre-coat Al/Cu Cond and Al/Cu Evap + Hail Guard	34	45	45	45
E-coat Al/Cu Cond and Al/Cu Evap + Hail Guard	34	45	45	45
E-coat Al/Cu Cond and E-coat Al/Cu Evap + Hail Guard	34	45	45	45
Cu/Cu Cond and Al/Cu Evap + Hail Guard	57	70	70	70
Cu/Cu Cond and Cu/Cu Evap + Hail Guard	83	92	92	92
Temp Ultra Low Leak Econo w/Baro Relief	74	103	103	103
Enthalpy Ultra Low Leak Econo w/Baro Relief	74	103	103	103
Unpowered Convenience Outlet	5	5	5	5
Powered Convenience Outlet	35	35	35	35
Hinged Panels	5	5	5	5
Hinged Panels with Unpowered Convenience Outlet	10	10	10	10
Hinged Panels with Powered Convenience Outlet	40	40	40	40
HACR Breaker	10	10	10	10
Non-Fused Disconnect	15	15	15	15



### 48LC 07 BASE UNIT DIMENSIONS (cont)

	UNITED STATES OF AMERICA P.O. BOX 4888 UNITED STATES OF AMERICA 13223 YORK, PA 17404-4888	THIS DOCUMENT IS THE PROPERTY OF CARRIER CORPORATION. IT IS TO BE USED ONLY FOR THE PROJECT AND CONTENTS WILL NOT BE DISCLOSED OR REPRODUCED IN ANY MANNER WITHOUT CARRIER CORPORATION'S WRITTEN CONSENT.	SUBMISSION OF THESE DRAWINGS OR DOCUMENTS CONSTITUTES ACCEPTANCE OF THE PERFORMANCE AND WARRANTY CONDITIONS OF CONTRACT.			
48LC 07 RTPF	STD. UNIT WEIGHT LBS. 1032 KG. 468	CORNER WEIGHT (A) LBS. 102 KG. 204	CORNER WEIGHT (B) LBS. 92 KG. 42	CORNER WEIGHT (C) LBS. 286 KG. 130	CORNER WEIGHT (D) LBS. 317 KG. 144	C.G. X 24 3/4 [629] Y 20 3/4 [527] Z

\*\*\* STANDARD UNIT WEIGHT IS WITH LOW GAS HEAT AND WITHOUT PACKAGING.  
 FOR OTHER OPTIONS AND ACCESSORIES, REFER TO THE PRODUCT DATA CATALOG.

CORNER A      CORNER B  
CORNER C      CORNER D

FRONT

SHEET 2 OF 2	DATE 7/11/14	SUPERSEDES 5/8/13	48LC 07 SINGLE ZONE ELECTRICAL COOLING WITH GAS HEAT	48LC500391	REV B
-----------------	-----------------	----------------------	---	------------	----------

## ROOF CURB DETAILS (SIZE 07)

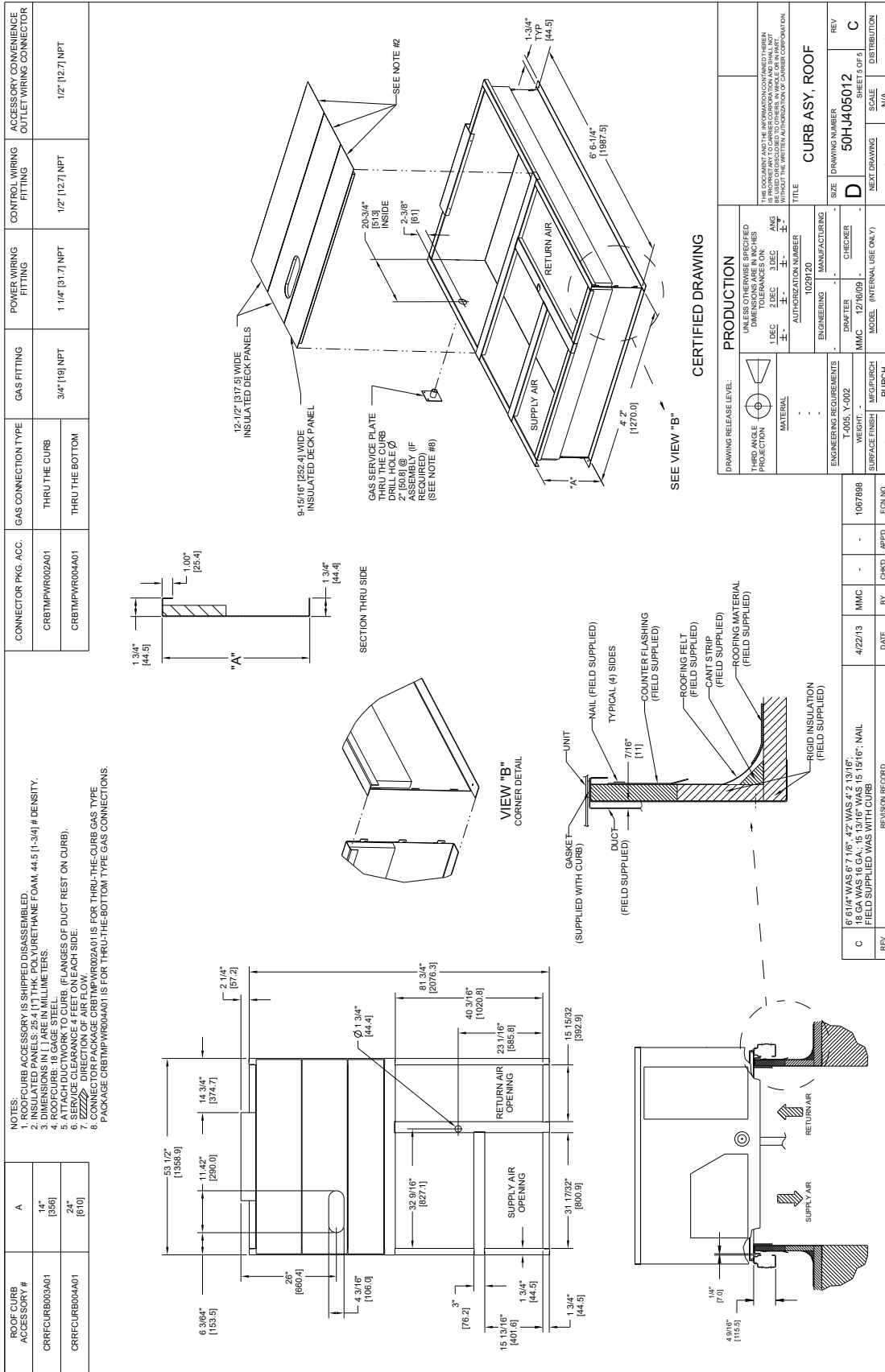



### 48LC 08 BASE UNIT DIMENSIONS

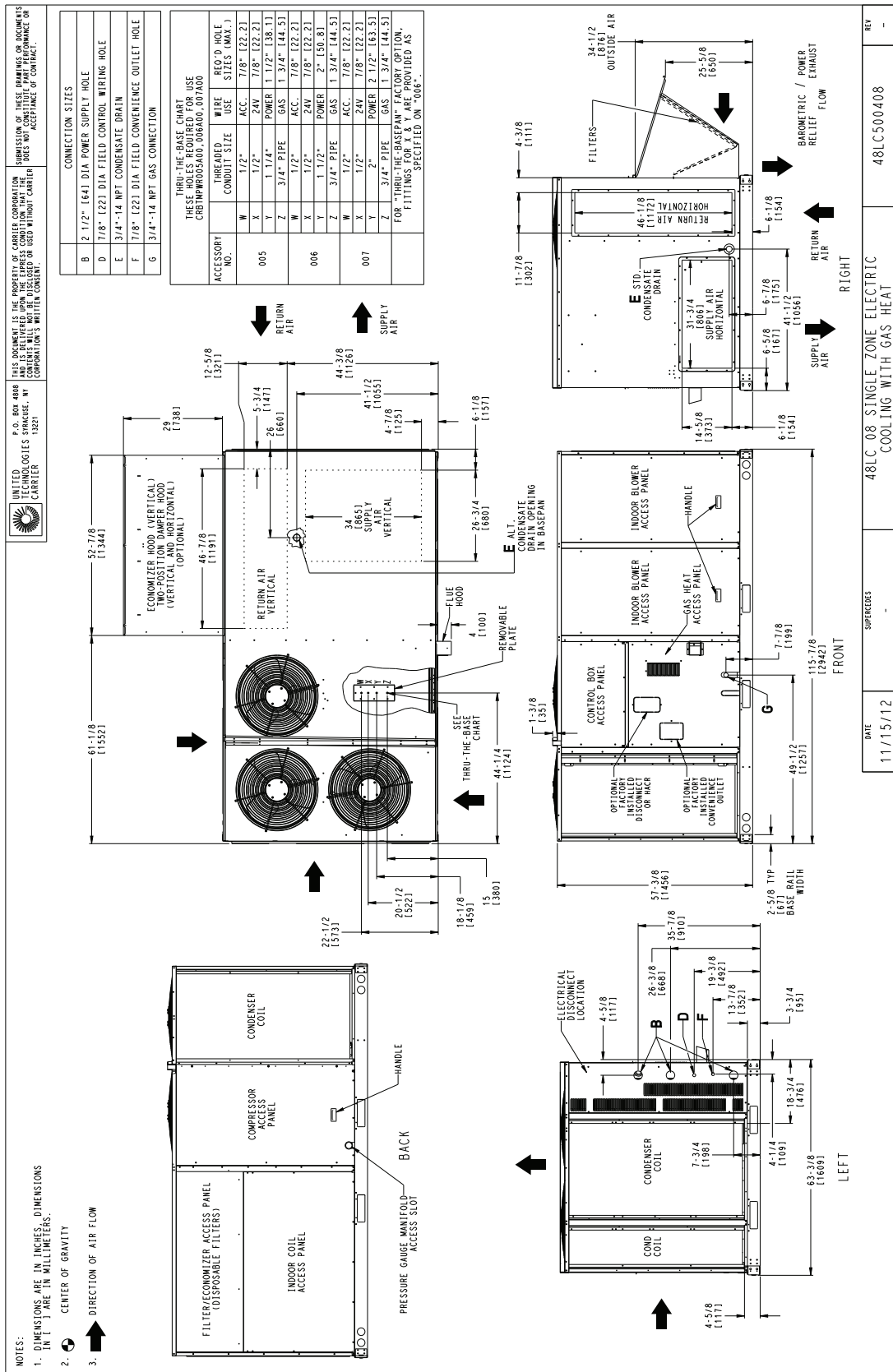

DATE	11/15/12	REV	-
SUPERSEDES	48LC 08 SINGLE ZONE ELECTRIC COOLING WITH GAS HEAT		
	48LC500408		

## 48LC 08 BASE UNIT DIMENSIONS (cont)

UNIT	STD UNIT WEIGHT	CORNER WEIGHT (A)	CORNER WEIGHT (B)	CORNER WEIGHT (C)	CORNER WEIGHT (D)	C.G.											
48LC 08	1606	728	426	193	415	188	377	171	387	176	57	1448	33	838	20	518	1525
	KG.	KG.	KG.	KG.	KG.	KG.	KG.	KG.	KG.	KG.	KG.	KG.	KG.	KG.	KG.	KG.	KG.

STANDARD UNIT WEIGHT IS WITH LOW GAS HEAT & WITHOUT PACKAGING. FOR OPTIONS & ACCESSORIES, REFER TO THE PRODUCT DATA CATALOG.

UNITED STATES OF AMERICA  
 UNITED TECHNOLOGIES SYRACUSE, NY 13221  
 CARRIER

THIS DOCUMENT IS THE PROPERTY OF CARRIER CORPORATION AND IS DELIVERED UNDER THE EXPRESS CONDITION THAT THE USER SHALL NOT REPRODUCE OR TRANSMIT THIS DOCUMENT OR ANY INFORMATION CONTAINED HEREIN WITHOUT CARRIER CORPORATION'S WRITTEN CONSENT.

SUBMISSION OF THESE DIMENSIONS OR DOCUMENTS TO ANY OTHER PARTY WITHOUT THE WRITTEN CONSENT OF CARRIER CORPORATION IS PROHIBITED.

**HORIZONTAL ECONOMIZER**

DATE  
11/15/12

SUPPLIERS  
-

48LC 08 SINGLE ZONE ELECTRIC COOLING WITH GAS HEAT

48LC500408

REV -

## 48LC 09-12 BASE UNIT DIMENSIONS

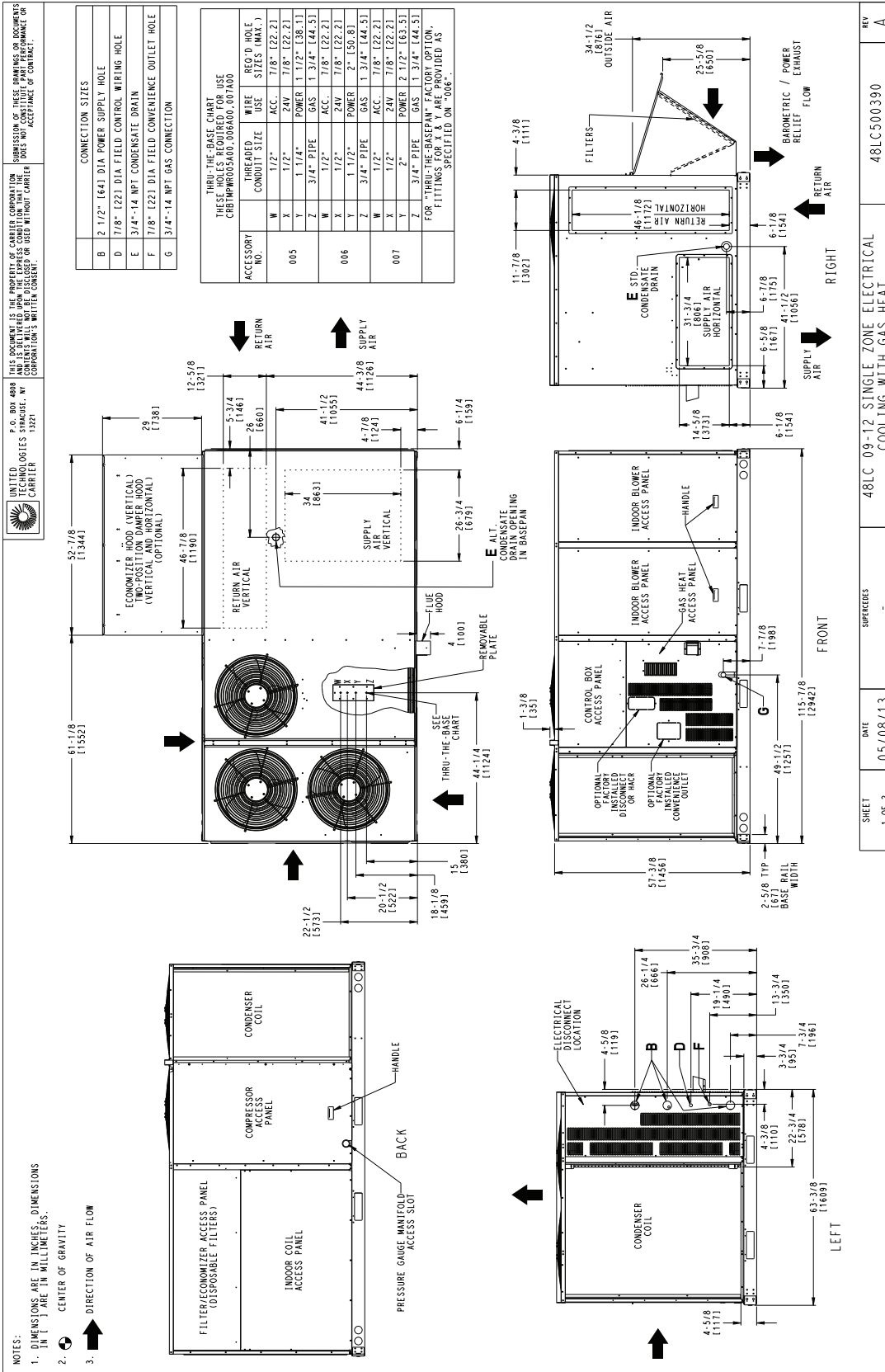

**FRONT VIEW DIMENSIONS:**

- Overall width: 61-1/8" (1552)
- Overall height: 48-7/8" (1190)
- Condenser coil height: 22-1/2" (571)
- Indoor blower height: 18-1/8" (459)
- Control panel height: 1-3/8" (35)
- Indoor blower access panel height: 1-7/8" (198)
- Gas heat access panel height: 1-7/8" (198)
- Indoor blower access panel height: 1-7/8" (198)
- Control panel height: 1-3/8" (35)
- Indoor blower height: 18-1/8" (459)
- Condenser coil height: 22-1/2" (571)

**LEFT VIEW DIMENSIONS:**

- Overall width: 63-3/8" (1609)
- Overall height: 48-7/8" (1190)
- Condenser coil height: 22-1/2" (571)
- Indoor blower height: 18-1/8" (459)
- Control panel height: 1-3/8" (35)
- Indoor blower access panel height: 1-7/8" (198)
- Gas heat access panel height: 1-7/8" (198)
- Indoor blower access panel height: 1-7/8" (198)
- Control panel height: 1-3/8" (35)
- Indoor blower height: 18-1/8" (459)
- Condenser coil height: 22-1/2" (571)

**RIGHT VIEW DIMENSIONS:**

- Overall width: 61-1/8" (1552)
- Overall height: 48-7/8" (1190)
- Condenser coil height: 22-1/2" (571)
- Indoor blower height: 18-1/8" (459)
- Control panel height: 1-3/8" (35)
- Indoor blower access panel height: 1-7/8" (198)
- Gas heat access panel height: 1-7/8" (198)
- Indoor blower access panel height: 1-7/8" (198)
- Control panel height: 1-3/8" (35)
- Indoor blower height: 18-1/8" (459)
- Condenser coil height: 22-1/2" (571)

**REVISIONS:**

REV	DESCRIPTION
A	48LC 09-12 SINGLE ZONE ELECTRICAL COOLING WITH GAS HEAT

**PROJECT INFORMATION:**

SHEET: 1 OF 2      DATE: 05/08/13      SUPERSEDES: -

## 48LC 09-12 BASE UNIT DIMENSIONS (cont)

UNIT	CORNER WEIGHT (A)		CORNER WEIGHT (C)		CORNER WEIGHT (D)		C.G.								
	KG	LB	KG	LB	KG	LB	X	Y							
48LC 09	1808	728	406	184	410	186	391	180	393	178	32	1872	20	216	1324
48LC 12	1808	728	406	184	410	186	391	180	393	178	38	1473	20	216	1324

STANDARD UNIT WEIGHT IS WITH LOW GAS HEAT & WITHOUT PACKAGING. FOR OPTIONS & ACCESSORIES, REFER TO THE PRODUCT DATA CATALOG.

CORNER B

CORNER C

CORNER A

CORNER D

TOP

FRONT

UNITED TECHNOLOGIES STRONGHOLD, NY 13221

P.O. BOX 4885

THIS DOCUMENT IS THE PROPERTY OF CARRIER CORPORATION AND IS DELIVERED UNDER THE EXPRESS CONDITION THAT THE USER SHALL NOT REPRODUCE OR USE WITHOUT CARRIER CORPORATION'S WRITTEN CONSENT.

SUBMISSION OF THESE DIMENSIONS OR DOCUMENTS TO ANY PROJECT CONSTITUTES ACCEPTANCE OF CONTRACT.

### HORIZONTAL ECONOMIZER

SHEET	DATE	DATE	SUPPLIERS	48LC 09-12 SINGLE ZONE ELECTRICAL COOLING WITH GAS HEAT	48LC500390	REV	A
2 OF 2	05/08/13						

### ROOF CURB DETAILS (SIZES 08-12)

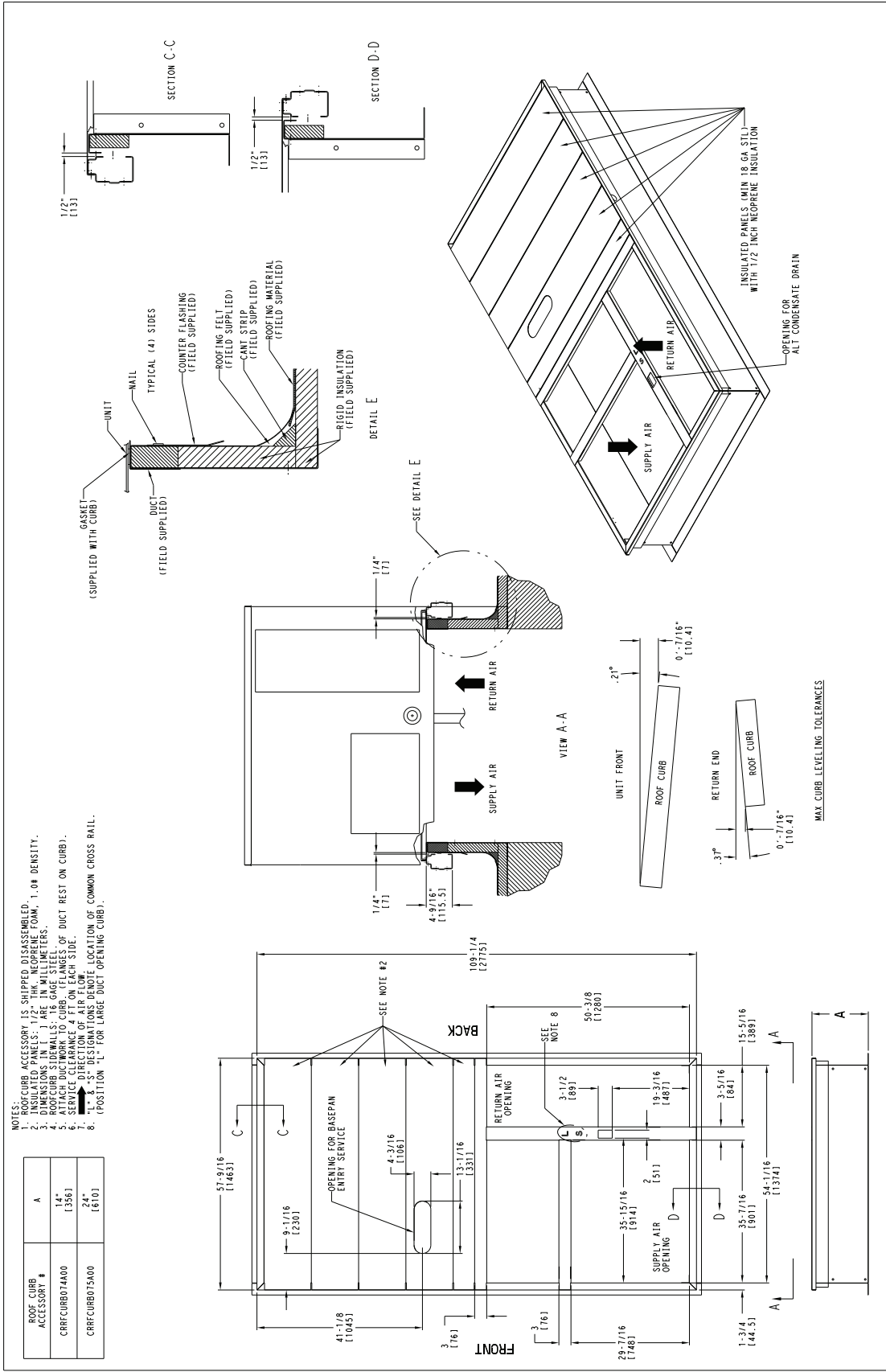

- NOTES:**
1. ROOF CURB ACCESSORY IS SHIPPED DISASSEMBLED.
  2. DIMENSIONS IN PARENT UNITS ARE IN INCHES. DIMENSIONS IN BRACKETED UNITS ARE IN MILLIMETERS.
  3. DIMENSIONS IN L, J ARE IN MILLIMETERS.
  4. ROOF CURB SIDEWALLS: 18 GAUGE STEEL.
  5. GASKET: 1/2" x 1/2" x 1/4" (13x13x6) WITH 1/2" x 1/2" x 1/4" (13x13x6) DUCT REST ON CURB.
  6. MAIL: 1/2" x 1/2" x 1/4" (13x13x6) ON FLANGES OF DUCT REST ON CURB.
  7. SEAL: 1/2" x 1/2" x 1/4" (13x13x6) ON FLANGES OF DUCT REST ON CURB.
  8. DIRECTION OF AIR FLOW.
  9. "L" & "S" DESIGNATIONS DENOTE LOCATION OF COMMON CROSS RAIL.
  10. (POSITION "L" FOR LARGE DUCT OPENING CURB).

ROOF CURB ACCESSORY #	A
CRRCURB074A00	14" (356)
CRRCURB075A00	24" (610)

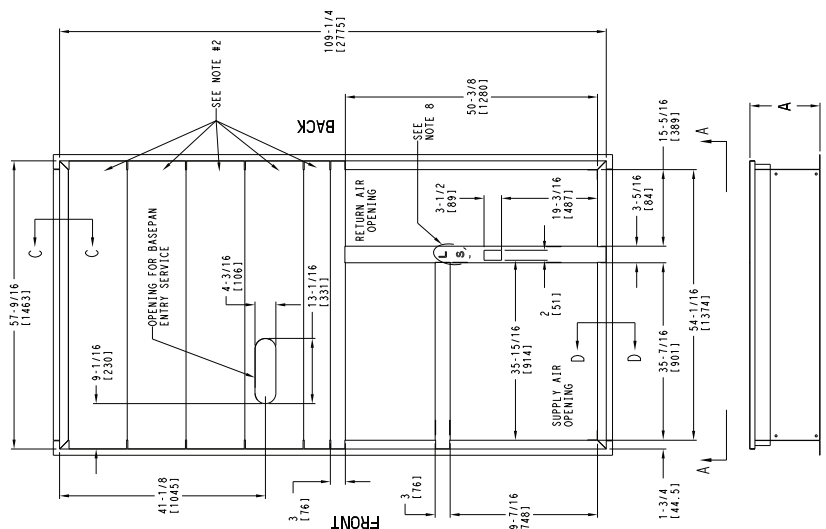

## SERVICE CLEARANCE DIMENSIONS

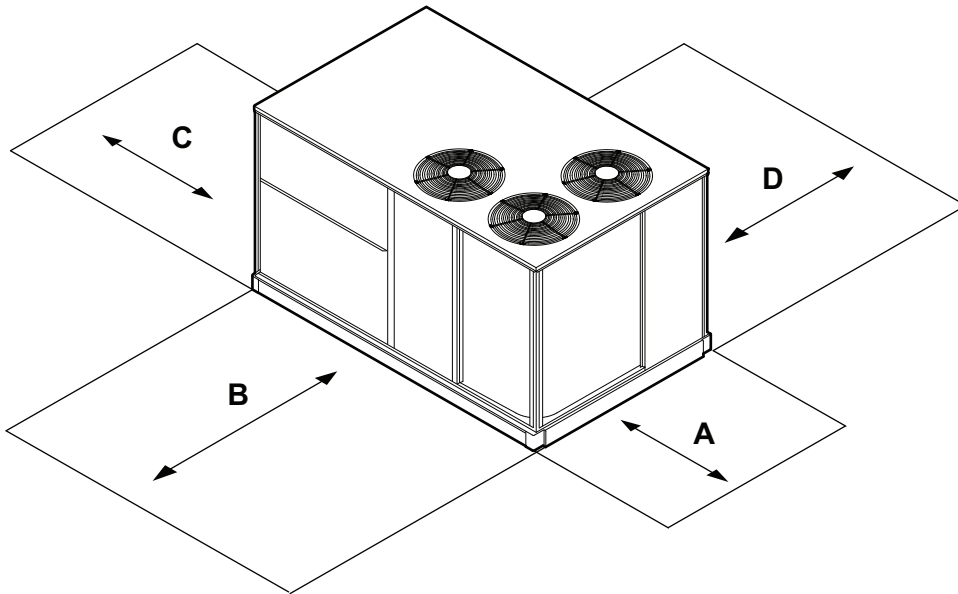

LOCATION	DIMENSION	CONDITION
A	48-in. (1219 mm)	Unit disconnect is mounted on panel
	18-in. (457 mm)	No disconnect, convenience outlet option
	18-in. (457 mm)	Recommended service clearance
	12-in. (305 mm)	Minimum clearance
B	40-in. (1067 mm)	Surface behind servicer is grounded (e.g., metal, masonry wall)
	36-in. (914 mm)	Surface behind servicer is electrically non-conductive (e.g., wood, fiberglass)
	Special	Check sources of flue products within 10 ft (3 m) of unit fresh air intake hood
C	36-in. (914 mm)	Side condensate drain is used
	18-in. (457 mm)	Minimum clearance
D	48-in. (1219 mm)	No flue discharge accessory installed, surface is combustible material
	42-in. (1067 mm)	Surface behind servicer is grounded (e.g., metal, masonry wall, another unit)
	36-in. (914 mm)	Surface behind servicer is electrically non-conductive (e.g., wood, fiberglass)
	Special	Check for adjacent units or building fresh air intakes within 10 ft (3 m) of this unit's flue outlet

**NOTES:**

1. Unit not designed to have overhead obstruction. Contact Application Engineering for guidance on any application planning overhead obstruction or for vertical clearances.
2. The number of fans varies with the unit size. Depending on size, unit will have two or three fans.

## COOLING CAPACITIES - FIRST STAGE, PART LOAD (6 TONS)

48LC SIZE 07			AMBIENT TEMPERATURE (°F)																	
			85			95			105			115			125					
			EA (db)			EA (db)			EA (db)			EA (db)			EA (db)					
			75	80	85	75	80	85	75	80	85	75	80	85	75	80	85			
1200 CFM	EA (wb)	58	TC	36.7	36.7	40.8	36.8	36.8	40.7	36.8	36.8	40.5	36.6	36.6	40.2	36.3	36.3	39.7		
		58	SHC	32.6	36.7	40.8	32.9	36.8	40.7	33.1	36.8	40.5	33.1	36.6	40.2	33.0	36.3	39.7		
		62	TC	36.7	36.7	42.1	36.8	36.8	42.0	36.8	36.8	41.7	36.7	36.7	41.3	36.3	36.3	40.8		
		62	SHC	31.2	36.7	42.1	31.6	36.8	42.0	31.8	36.8	41.7	31.9	36.7	41.3	31.9	36.3	40.8		
		67	TC	38.1	38.1	38.3	37.9	37.9	39.1	37.6	37.6	39.8	37.2	37.2	40.5	36.7	36.7	41.0		
		67	SHC	25.9	32.1	38.3	26.7	32.9	39.1	27.5	33.6	39.8	28.2	34.3	40.5	28.8	34.9	41.0		
	EA (wb)	72	TC	40.8	40.8	40.8	40.5	40.5	40.5	40.0	40.0	40.0	39.4	39.4	39.4	38.6	38.6	38.6		
		72	SHC	19.1	25.4	31.6	19.9	26.1	32.4	20.7	26.9	33.2	21.5	27.7	33.8	22.1	28.4	34.5		
		76	TC	—	43.2	43.2	—	42.7	42.7	—	42.1	42.1	—	41.3	41.3	—	40.5	40.5		
		76	SHC	—	19.8	26.0	—	20.6	26.9	—	21.4	27.7	—	22.1	28.4	—	22.8	29.1		
		1400 CFM	EA (wb)	58	TC	37.6	37.6	41.8	37.6	37.6	41.7	37.5	37.5	41.4	37.2	37.2	41.0	36.9	36.9	40.4
				58	SHC	33.3	37.6	41.8	33.5	37.6	41.7	33.6	37.5	41.4	33.6	37.2	41.0	33.4	36.9	40.4
62	TC			37.6	37.6	43.3	37.6	37.6	43.1	37.5	37.5	42.7	37.2	37.2	42.2	36.9	36.9	41.5		
62	SHC			32.0	37.6	43.3	32.2	37.6	43.1	32.4	37.5	42.7	32.4	37.2	42.2	32.3	36.9	41.5		
67	TC			38.5	38.5	41.3	38.3	38.3	42.1	37.9	37.9	42.7	37.5	37.5	43.2	37.0	37.0	43.5		
67	SHC			27.2	34.2	41.3	28.0	35.0	42.1	28.7	35.7	42.7	29.3	36.3	43.2	29.8	36.7	43.5		
EA (wb)	72		TC	41.1	41.1	41.1	40.8	40.8	40.8	40.3	40.3	40.3	39.6	39.6	39.6	38.7	38.7	38.7		
	72		SHC	19.5	26.6	33.8	20.3	27.5	34.6	21.1	28.2	35.4	21.8	29.0	36.1	22.5	29.6	36.8		
	76		TC	—	43.6	43.6	—	43.1	43.1	—	42.4	42.4	—	41.6	41.6	—	40.7	40.7		
	76		SHC	—	20.4	27.6	—	21.2	28.4	—	21.9	29.2	—	22.7	29.9	—	23.4	30.6		
	1600 CFM		EA (wb)	58	TC	38.4	38.4	42.8	38.3	38.3	42.5	38.1	38.1	42.1	37.8	37.8	41.6	37.3	37.3	41.0
				58	SHC	34.0	38.4	42.8	34.1	38.3	42.5	34.1	38.1	42.1	34.0	37.8	41.6	33.8	37.3	41.0
62		TC		38.4	38.4	44.3	38.3	38.3	44.0	38.1	38.1	43.5	37.8	37.8	42.9	37.3	37.3	42.1		
62		SHC		32.6	38.4	44.3	32.8	38.3	44.0	32.8	38.1	43.5	32.8	37.8	42.9	32.6	37.3	42.1		
67		TC		38.9	38.9	44.3	38.6	38.6	44.9	38.3	38.3	45.2	37.8	37.8	45.4	37.3	37.3	44.6		
67		SHC		28.4	36.3	44.3	29.2	37.0	44.9	29.7	37.5	45.2	30.2	37.8	45.4	30.2	37.3	44.6		
EA (wb)		72	TC	41.4	41.4	41.4	41.0	41.0	41.0	40.5	40.5	40.5	39.7	39.7	39.7	38.8	38.8	38.9		
		72	SHC	19.9	28.0	36.1	20.7	28.8	36.9	21.5	29.5	37.5	22.2	30.2	38.3	22.8	30.9	38.9		
		76	TC	—	44.0	44.0	—	43.4	43.4	—	42.6	42.6	—	41.8	41.8	—	40.8	40.8		
		76	SHC	—	21.0	29.2	—	21.8	29.9	—	22.6	30.7	—	23.3	31.4	—	24.0	32.1		
		1800 CFM	EA (wb)	58	TC	39.0	39.0	43.6	38.9	38.9	43.2	38.7	38.7	42.8	38.3	38.3	42.2	37.7	37.7	41.4
				58	SHC	34.5	39.0	43.6	34.6	38.9	43.2	34.6	38.7	42.8	34.4	38.3	42.2	34.1	37.7	41.4
62	TC			39.1	39.1	45.0	38.9	38.9	44.8	38.7	38.7	44.2	38.3	38.3	43.5	37.8	37.8	42.7		
62	SHC			33.1	39.1	45.0	33.2	38.9	44.8	33.2	38.7	44.2	33.2	38.3	43.5	32.9	37.8	42.7		
67	TC			39.3	39.3	46.8	39.1	39.1	46.2	38.7	38.7	47.0	38.3	38.3	46.1	37.8	37.8	45.1		
67	SHC			29.4	38.1	46.8	29.7	38.0	46.2	30.5	38.7	47.0	30.5	38.3	46.1	30.5	37.8	45.1		
EA (wb)	72		TC	41.7	41.7	41.7	41.1	41.1	41.1	40.6	40.6	40.6	39.9	39.9	40.5	38.9	38.9	41.0		
	72		SHC	20.3	29.3	38.2	21.1	30.0	39.0	21.8	30.8	39.7	22.6	31.5	40.5	23.2	32.2	41.0		
	76		TC	—	44.2	44.2	—	43.6	43.6	—	42.8	42.8	—	41.9	41.9	—	40.9	40.9		
	76		SHC	—	21.6	30.6	—	22.4	31.4	—	23.2	32.2	—	23.9	32.9	—	24.6	33.5		
	2000 CFM		EA (wb)	58	TC	39.6	39.6	44.3	39.4	39.4	43.9	39.1	39.1	43.4	38.7	38.7	42.7	38.1	38.1	41.8
				58	SHC	35.0	39.6	44.3	35.0	39.4	43.9	34.9	39.1	43.4	34.7	38.7	42.7	34.4	38.1	41.8
62		TC		39.6	39.6	45.8	39.5	39.5	45.3	39.2	39.2	44.8	38.7	38.7	44.1	38.1	38.1	43.1		
62		SHC		33.4	39.6	45.8	33.5	39.5	45.3	33.5	39.2	44.8	33.4	38.7	44.1	33.2	38.1	43.1		
67		TC		39.7	39.7	48.8	39.5	39.5	48.4	39.2	39.2	47.6	38.7	38.7	46.7	38.1	38.1	45.6		
67		SHC		30.4	39.7	48.8	30.6	39.5	48.4	30.7	39.2	47.6	30.8	38.7	46.7	30.7	38.1	45.6		
EA (wb)		72	TC	41.8	41.8	41.8	41.3	41.3	41.3	40.7	40.7	41.8	40.0	40.0	42.5	39.0	39.0	43.1		
		72	SHC	20.8	30.5	40.4	21.5	31.3	41.0	22.2	32.1	41.8	23.0	32.8	42.5	23.6	33.3	43.1		
		76	TC	—	44.5	44.5	—	43.8	43.8	—	43.0	43.0	—	42.0	42.0	—	41.0	41.0		
		76	SHC	—	22.2	32.1	—	23.0	32.9	—	23.8	33.5	—	24.5	34.3	—	25.2	34.9		

### LEGEND

- Do not operate
- CFM — Cubic feet per minute (supply air)
- EAT (db) — Entering Air Temperature (dry bulb)
- EAT (wb) — Entering Air Temperature (wet bulb)
- SHC — Sensible Heat Capacity (1000 Btuh) Gross
- TC — Total Capacity (1000 Btuh) Gross



## COOLING CAPACITIES - SECOND STAGE, PART LOAD (6 TONS)

48LC SIZE 07			AMBIENT TEMPERATURE (°F)															
			85			95			105			115			125			
			EA (db)			EA (db)			EA (db)			EA (db)			EA (db)			
			75	80	85	75	80	85	75	80	85	75	80	85	75	80	85	
1200 CFM	EA (wb)	58 TC	42.3	42.3	47.6	41.0	41.0	46.1	39.7	39.7	44.5	38.1	38.1	42.7	36.6	36.6	40.9	
		58 SHC	37.1	42.3	47.6	36.1	41.0	46.1	34.9	39.7	44.5	33.6	38.1	42.7	32.2	36.6	40.9	
		62 TC	43.4	43.4	46.6	41.7	41.7	45.9	40.1	40.1	45.1	38.3	38.3	44.1	36.6	36.6	42.3	
		62 SHC	34.2	40.4	46.6	33.5	39.8	45.9	32.9	39.0	45.1	32.1	38.1	44.1	30.8	36.6	42.3	
		67 TC	47.0	47.0	47.0	45.1	45.1	45.1	43.2	43.2	43.2	41.0	41.0	41.0	38.8	38.8	38.8	
		67 SHC	27.9	34.1	40.5	27.3	33.5	39.9	26.7	33.0	39.2	26.0	32.3	38.5	25.4	31.6	37.8	
	72 TC	51.1	51.1	51.1	49.0	49.0	49.0	46.9	46.9	46.9	44.6	44.6	44.6	42.0	42.0	42.0		
	72 SHC	21.4	27.7	34.0	20.9	27.1	33.4	20.3	26.5	32.9	19.6	25.8	32.2	18.9	25.2	31.4		
	76 TC	—	54.6	54.6	—	52.5	52.5	—	50.0	50.0	—	47.5	47.5	—	44.8	44.8		
	76 SHC	—	22.4	28.9	—	21.9	28.3	—	21.4	27.7	—	20.7	27.0	—	20.0	26.3		
	1400 CFM	EA (wb)	58 TC	44.3	44.3	49.7	42.9	42.9	48.2	41.3	41.3	46.3	39.7	39.7	44.5	37.9	37.9	42.4
			58 SHC	38.8	44.3	49.7	37.6	42.9	48.2	36.4	41.3	46.3	34.9	39.7	44.5	33.3	37.9	42.4
62 TC			44.6	44.6	50.7	43.0	43.0	49.7	41.4	41.4	48.1	39.7	39.7	46.1	37.9	37.9	43.9	
62 SHC			36.6	43.6	50.7	35.8	42.7	49.7	34.7	41.4	48.1	33.3	39.7	46.1	31.9	37.9	43.9	
67 TC			48.0	48.0	48.0	46.0	46.0	46.0	44.0	44.0	44.0	41.7	41.7	41.9	39.4	39.4	41.1	
67 SHC			29.4	36.7	43.9	28.9	36.1	43.3	28.3	35.4	42.6	27.5	34.7	41.9	26.8	33.9	41.1	
72 TC		52.2	52.2	52.2	50.0	50.0	50.0	47.7	47.7	47.7	45.2	45.2	45.2	42.7	42.7	42.7		
72 SHC		22.0	29.3	36.6	21.5	28.7	36.0	20.9	28.1	35.3	20.2	27.4	34.6	19.5	26.7	33.8		
76 TC		—	55.7	55.7	—	53.3	53.3	—	50.9	50.9	—	48.3	48.3	—	45.4	45.4		
76 SHC		—	23.2	30.6	—	22.7	30.0	—	22.0	29.3	—	21.5	28.7	—	20.7	28.0		
1600 CFM		EA (wb)	58 TC	45.8	45.8	51.6	44.4	44.4	49.8	42.7	42.7	47.9	41.0	41.0	45.8	39.0	39.0	43.7
			58 SHC	40.2	45.8	51.6	38.9	44.4	49.8	37.5	42.7	47.9	36.0	41.0	45.8	34.3	39.0	43.7
	62 TC		45.9	45.9	53.5	44.4	44.4	51.7	42.7	42.7	49.7	41.0	41.0	47.6	39.0	39.0	45.2	
	62 SHC		38.3	45.9	53.5	37.1	44.4	51.7	35.8	42.7	49.7	34.4	41.0	47.6	32.9	39.0	45.2	
	67 TC		48.8	48.8	48.8	46.7	46.7	46.7	44.7	44.7	45.9	42.3	42.3	45.1	40.0	40.0	44.2	
	67 SHC		30.9	39.1	47.3	30.3	38.5	46.6	29.7	37.8	45.9	29.0	37.1	45.1	28.2	36.2	44.2	
	72 TC	52.9	52.9	52.9	50.7	50.7	50.7	48.4	48.4	48.4	45.8	45.8	45.8	43.1	43.1	43.1		
	72 SHC	22.6	30.8	38.9	22.0	30.1	38.3	21.4	29.5	37.6	20.8	28.9	37.0	20.0	28.1	36.2		
	76 TC	—	56.5	56.5	—	54.0	54.0	—	51.5	51.5	—	48.8	48.8	—	45.8	45.8		
	76 SHC	—	24.0	32.3	—	23.4	31.7	—	22.8	31.0	—	22.1	30.2	—	21.5	29.4		
	1800 CFM	EA (wb)	58 TC	47.2	47.2	53.0	45.6	45.6	51.2	43.9	43.9	49.2	41.9	41.9	47.0	39.9	39.9	44.7
			58 SHC	41.3	47.2	53.0	40.0	45.6	51.2	38.5	43.9	49.2	36.9	41.9	47.0	35.1	39.9	44.7
62 TC			47.2	47.2	55.1	45.6	45.6	53.1	43.9	43.9	51.0	42.0	42.0	48.8	40.0	40.0	46.3	
62 SHC			39.4	47.2	55.1	38.1	45.6	53.1	36.8	43.9	51.0	35.2	42.0	48.8	33.5	40.0	46.3	
67 TC			49.3	49.3	50.4	47.3	47.3	49.7	45.1	45.1	49.0	42.8	42.8	48.2	40.5	40.5	47.1	
67 SHC			32.4	41.4	50.4	31.8	40.8	49.7	31.1	40.1	49.0	30.3	39.2	48.2	29.4	38.3	47.1	
72 TC		53.5	53.5	53.5	51.3	51.3	51.3	48.8	48.8	48.8	46.2	46.2	46.2	43.5	43.5	43.5		
72 SHC		23.1	32.2	41.2	22.5	31.6	40.7	21.9	30.9	40.0	21.3	30.2	39.2	20.5	29.4	38.4		
76 TC		—	57.0	57.0	—	54.6	54.6	—	52.0	52.0	—	49.1	49.1	—	46.2	46.2		
76 SHC		—	24.7	33.8	—	24.1	33.2	—	23.5	32.5	—	22.8	31.8	—	22.0	31.0		
2000 CFM		EA (wb)	58 TC	48.4	48.4	54.3	46.6	46.6	52.4	44.9	44.9	50.3	42.8	42.8	48.0	40.7	40.7	45.5
			58 SHC	42.3	48.4	54.3	40.9	46.6	52.4	39.3	44.9	50.3	37.6	42.8	48.0	35.8	40.7	45.5
	62 TC		48.4	48.4	56.4	46.7	46.7	54.4	44.9	44.9	52.2	42.9	42.9	49.8	40.8	40.8	47.2	
	62 SHC		40.4	48.4	56.4	39.0	46.7	54.4	37.5	44.9	52.2	36.0	42.9	49.8	34.2	40.8	47.2	
	67 TC		49.9	49.9	53.5	47.9	47.9	52.7	45.6	45.6	51.9	43.3	43.3	50.9	40.9	40.9	49.5	
	67 SHC		33.7	43.6	53.5	33.1	42.9	52.7	32.4	42.1	51.9	31.6	41.2	50.9	30.6	40.1	49.5	
	72 TC	54.0	54.0	54.0	51.7	51.7	51.7	49.1	49.1	49.1	46.5	46.5	46.5	43.7	43.7	43.7		
	72 SHC	23.7	33.5	43.5	23.1	33.0	42.8	22.4	32.3	42.1	21.7	31.6	41.4	21.0	30.8	40.6		
	76 TC	—	57.5	57.5	—	55.0	55.0	—	52.4	52.4	—	49.5	49.5	—	46.5	46.5		
	76 SHC	—	25.4	35.3	—	24.8	34.7	—	24.2	34.0	—	23.4	33.2	—	22.7	32.4		

### LEGEND

- Do not operate
- CFM — Cubic feet per minute (supply air)
- EAT (db) — Entering Air Temperature (dry bulb)
- EAT (wb) — Entering Air Temperature (wet bulb)
- SHC — Sensible Heat Capacity (1000 Btuh) Gross
- TC — Total Capacity (1000 Btuh) Gross





### COOLING CAPACITIES - THIRD STAGE, FULL LOAD (6 TONS)

48LC SIZE 07			AMBIENT TEMPERATURE (°F)																
			85			95			105			115			125				
			EA (db)			EA (db)			EA (db)			EA (db)			EA (db)				
			75	80	85	75	80	85	75	80	85	75	80	85	75	80	85		
1800 CFM	EA (wb)	58	TC	63.9	63.9	72.2	61.1	61.1	69.1	58.1	58.1	65.8	55.0	55.0	62.2	51.6	51.6	58.4	
			SHC	55.6	63.9	72.2	53.1	61.1	69.1	50.5	58.1	65.8	47.7	55.0	62.2	44.7	51.6	58.4	
		62	TC	66.4	66.4	68.9	63.0	63.0	67.1	59.5	59.5	65.0	55.7	55.7	63.0	51.8	51.8	60.4	
			SHC	50.2	59.6	68.9	48.5	57.7	67.1	46.5	55.8	65.0	44.5	53.7	63.0	42.2	51.3	60.4	
		67	TC	72.8	72.8	72.8	69.0	69.0	69.0	65.0	65.0	65.0	60.7	60.7	60.7	56.4	56.4	56.4	
			SHC	41.1	50.6	60.0	39.4	48.8	58.1	37.5	46.9	56.3	35.6	44.9	54.3	33.5	42.9	52.3	
		72	TC	80.0	80.0	80.0	75.9	75.9	75.9	71.6	71.6	71.6	67.0	67.0	67.0	62.0	62.0	62.0	
		SHC	31.9	41.3	50.8	30.1	39.6	49.0	28.3	37.7	47.1	26.4	35.8	45.1	24.4	33.7	43.1		
		76	TC	—	85.9	85.9	—	81.5	81.5	—	76.9	76.9	—	72.0	72.0	—	66.8	66.8	
		SHC	—	33.8	43.5	—	32.1	41.7	—	30.2	39.9	—	28.4	37.9	—	26.3	35.8		
	2100 CFM	EA (wb)	58	TC	67.5	67.5	76.1	64.4	64.4	72.8	61.2	61.2	69.2	57.8	57.8	65.4	54.1	54.1	61.3
				SHC	58.7	67.5	76.1	56.1	64.4	72.8	53.2	61.2	69.2	50.2	57.8	65.4	46.9	54.1	61.3
62			TC	68.6	68.6	75.7	65.1	65.1	73.6	61.5	61.5	71.3	57.9	57.9	68.1	54.2	54.2	63.8	
			SHC	54.2	64.9	75.7	52.4	63.0	73.6	50.2	60.7	71.3	47.7	57.9	68.1	44.6	54.2	63.8	
67			TC	74.7	74.7	74.7	70.8	70.8	70.8	66.6	66.6	66.6	62.2	62.2	62.2	57.5	57.5	57.5	
			SHC	43.8	54.6	65.4	41.9	52.7	63.6	40.0	50.8	61.6	38.0	48.8	59.6	36.0	46.7	57.4	
		72	TC	81.9	81.9	81.9	77.6	77.6	77.6	73.1	73.1	73.1	68.3	68.3	68.3	63.3	63.3	63.3	
		SHC	33.1	43.9	54.8	31.3	42.1	52.9	29.3	40.2	51.0	27.4	38.2	48.9	25.4	36.1	46.9		
		76	TC	—	87.8	87.8	—	83.3	83.3	—	78.5	78.5	—	73.3	73.3	—	68.0	68.0	
		SHC	—	35.2	46.3	—	33.4	44.5	—	31.6	42.5	—	29.5	40.5	—	27.5	38.4		
2400 CFM		EA (wb)	58	TC	70.4	70.4	79.5	67.2	67.2	75.9	63.8	63.8	72.1	60.2	60.2	68.1	56.3	56.3	63.7
				SHC	61.3	70.4	79.5	58.5	67.2	75.9	55.5	63.8	72.1	52.3	60.2	68.1	48.8	56.3	63.7
	62		TC	70.7	70.7	81.6	67.3	67.3	78.9	63.9	63.9	75.0	60.2	60.2	70.8	56.3	56.3	66.2	
			SHC	57.8	69.7	81.6	55.6	67.3	78.9	52.7	63.9	75.0	49.6	60.2	70.8	46.3	56.3	66.2	
	67		TC	76.2	76.2	76.2	72.2	72.2	72.2	67.9	67.9	67.9	63.4	63.4	64.5	58.6	58.6	62.3	
			SHC	46.2	58.4	70.6	44.3	56.5	68.6	42.4	54.5	66.7	40.4	52.5	64.5	38.2	50.3	62.3	
		72	TC	83.5	83.5	83.5	79.0	79.0	79.0	74.4	74.4	74.4	69.4	69.4	69.4	64.2	64.2	64.2	
		SHC	34.0	46.3	58.5	32.3	44.5	56.6	30.3	42.5	54.6	28.4	40.5	52.6	26.3	38.3	50.4		
		76	TC	—	89.4	89.4	—	84.6	84.6	—	79.7	79.7	—	74.4	74.4	—	68.8	68.8	
		SHC	—	36.5	48.9	—	34.7	47.0	—	32.8	45.0	—	30.7	42.9	—	28.7	40.8		
	2700 CFM	EA (wb)	58	TC	72.8	72.8	82.2	69.5	69.5	78.5	65.9	65.9	74.5	62.1	62.1	70.2	58.0	58.0	65.6
				SHC	63.5	72.8	82.2	60.5	69.5	78.5	57.3	65.9	74.5	53.9	62.1	70.2	50.3	58.0	65.6
62			TC	72.9	72.9	85.4	69.5	69.5	81.6	65.9	65.9	77.4	62.1	62.1	73.0	58.0	58.0	68.3	
			SHC	60.4	72.9	85.4	57.5	69.5	81.6	54.5	65.9	77.4	51.3	62.1	73.0	47.8	58.0	68.3	
67			TC	77.4	77.4	77.4	73.3	73.3	73.6	68.9	68.9	71.5	64.3	64.3	69.3	59.5	59.5	67.0	
			SHC	48.5	62.0	75.6	46.6	60.1	73.6	44.6	58.0	71.5	42.5	56.0	69.3	40.4	53.6	67.0	
		72	TC	84.6	84.6	84.6	80.0	80.0	80.0	75.3	75.3	75.3	70.3	70.3	70.3	64.9	64.9	64.9	
		SHC	35.0	48.6	62.0	33.2	46.6	60.2	31.2	44.7	58.1	29.3	42.6	56.0	27.1	40.5	53.8		
		76	TC	—	90.6	90.6	—	85.7	85.7	—	80.6	80.6	—	75.2	75.2	—	69.4	69.4	
		SHC	—	37.6	51.3	—	35.8	49.4	—	33.8	47.4	—	31.8	45.2	—	29.6	42.9		
3000 CFM		EA (wb)	58	TC	74.9	74.9	84.5	71.4	71.4	80.6	67.7	67.7	76.4	63.7	63.7	72.1	59.4	59.4	67.3
				SHC	65.2	74.9	84.5	62.1	71.4	80.6	58.9	67.7	76.4	55.4	63.7	72.1	51.6	59.4	67.3
	62		TC	75.0	75.0	87.8	71.5	71.5	83.8	67.7	67.7	79.5	63.8	63.8	74.9	59.5	59.5	69.9	
			SHC	62.1	75.0	87.8	59.1	71.5	83.8	56.0	67.7	79.5	52.6	63.8	74.9	49.0	59.5	69.9	
	67		TC	78.5	78.5	80.2	74.2	74.2	78.3	69.8	69.8	76.1	65.1	65.1	73.8	60.3	60.3	71.3	
			SHC	50.7	65.4	80.2	48.8	63.5	78.3	46.7	61.4	76.1	44.6	59.2	73.8	42.3	56.7	71.3	
		72	TC	85.6	85.6	85.6	80.9	80.9	80.9	76.1	76.1	76.1	70.9	70.9	70.9	65.5	65.5	65.5	
		SHC	35.9	50.7	65.4	34.0	48.8	63.5	32.1	46.8	61.4	30.0	44.7	59.3	27.9	42.5	57.0		
		76	TC	—	91.5	91.5	—	86.6	86.6	—	81.3	81.3	—	75.9	75.9	—	70.0	70.0	
		SHC	—	38.8	53.6	—	36.9	51.7	—	34.9	49.5	—	32.9	47.4	—	30.6	45.0		

**LEGEND**

- Do not operate
- CFM — Cubic feet per minute (supply air)
- EAT (db) — Entering Air Temperature (dry bulb)
- EAT (wb) — Entering Air Temperature (wet bulb)
- SHC — Sensible Heat Capacity (1000 Btuh) Gross
- TC — Total Capacity (1000 Btuh) Gross



## COOLING CAPACITIES - FIRST STAGE, PART LOAD (7.5 TONS)

48LC SIZE 08			AMBIENT TEMPERATURE (°F)																
			85			95			105			115			125				
			EA (db)			EA (db)			EA (db)			EA (db)			EA (db)				
			75	80	85	75	80	85	75	80	85	75	80	85	75	80	85		
1500 CFM	EA (wb)	58	TC	39.3	39.3	45.0	36.1	36.1	41.5	32.7	32.7	37.8	29.2	29.2	34.0	25.4	25.4	30.0	
		58	SHC	33.6	39.3	45.0	30.6	36.1	41.5	27.5	32.7	37.8	24.2	29.2	34.0	20.8	25.4	30.0	
		62	TC	39.4	39.4	47.0	36.1	36.1	43.4	32.7	32.7	39.7	29.2	29.2	35.8	25.4	25.4	31.7	
			SHC	31.8	39.4	47.0	28.9	36.1	43.4	25.7	32.7	39.7	22.6	29.2	35.8	19.3	25.4	31.7	
		67	TC	43.9	43.9	43.9	39.9	39.9	39.9	35.8	35.8	36.1	31.5	31.5	33.3	27.1	27.1	30.7	
			SHC	25.4	33.2	41.1	22.8	30.7	38.6	20.2	28.1	36.1	17.6	25.5	33.3	14.9	22.8	30.7	
	72	TC	49.3	49.3	49.3	45.1	45.1	45.1	40.8	40.8	40.8	36.3	36.3	36.3	31.6	31.6	31.6		
		SHC	18.3	26.2	34.2	15.8	23.8	31.7	13.3	21.2	29.2	10.6	18.6	26.5	8.0	16.0	23.9		
	76	TC	—	53.9	53.9	—	49.6	49.6	—	45.0	45.0	—	40.4	40.4	—	35.5	35.5		
		SHC	—	20.6	28.6	—	18.0	26.1	—	15.5	23.5	—	13.0	21.0	—	10.3	18.3		
	1750 CFM	EA (wb)	58	TC	41.8	41.8	47.8	38.3	38.3	44.1	34.8	34.8	40.2	31.1	31.1	36.2	27.2	27.2	32.0
			58	SHC	35.9	41.8	47.8	32.7	38.3	44.1	29.3	34.8	40.2	25.9	31.1	36.2	22.3	27.2	32.0
62			TC	41.8	41.8	49.8	38.4	38.4	46.0	34.8	34.8	42.0	31.1	31.1	37.9	27.2	27.2	33.6	
			SHC	33.9	41.8	49.8	30.8	38.4	46.0	27.6	34.8	42.0	24.3	31.1	37.9	20.8	27.2	33.6	
67			TC	45.0	45.0	45.9	41.0	41.0	43.3	36.8	36.8	40.7	32.4	32.4	37.8	27.9	27.9	35.0	
			SHC	27.6	36.8	45.9	25.1	34.1	43.3	22.4	31.5	40.7	19.7	28.8	37.8	17.0	26.0	35.0	
72		TC	50.5	50.5	50.5	46.1	46.1	46.1	41.7	41.7	41.7	37.1	37.1	37.1	32.3	32.3	32.3		
		SHC	19.3	28.6	37.7	16.8	26.0	35.2	14.2	23.4	32.6	11.6	20.8	29.9	8.9	18.0	27.2		
76		TC	—	55.2	55.2	—	50.7	50.7	—	46.0	46.0	—	41.2	41.2	—	36.2	36.2		
		SHC	—	21.8	31.1	—	19.3	28.6	—	16.8	25.9	—	14.1	23.3	—	11.4	20.7		
2000 CFM		EA (wb)	58	TC	43.9	43.9	50.0	40.3	40.3	46.1	36.5	36.5	42.1	32.7	32.7	37.9	28.6	28.6	33.5
			58	SHC	37.7	43.9	50.0	34.3	40.3	46.1	30.9	36.5	42.1	27.3	32.7	37.9	23.6	28.6	33.5
	62		TC	43.9	43.9	52.1	40.3	40.3	48.2	36.6	36.6	44.1	32.7	32.7	39.8	28.7	28.7	35.3	
			SHC	35.7	43.9	52.1	32.5	40.3	48.2	29.1	36.6	44.1	25.6	32.7	39.8	22.0	28.7	35.3	
	67		TC	45.9	45.9	50.3	41.8	41.8	47.7	37.5	37.5	44.9	33.2	33.2	41.9	28.8	28.8	38.3	
			SHC	29.7	40.1	50.3	27.1	37.3	47.7	24.5	34.7	44.9	21.6	31.8	41.9	18.6	28.5	38.3	
	72	TC	51.3	51.3	51.3	46.9	46.9	46.9	42.4	42.4	42.4	37.6	37.6	37.6	32.8	32.8	32.8		
		SHC	20.3	30.7	41.1	17.7	28.1	38.5	15.1	25.4	35.9	12.4	22.8	33.2	9.8	20.1	30.5		
	76	TC	—	56.1	56.1	—	51.5	51.5	—	46.7	46.7	—	41.8	41.8	—	36.8	36.8		
		SHC	—	23.0	33.5	—	20.5	30.9	—	17.8	28.3	—	15.2	25.6	—	12.5	22.9		
	2250 CFM	EA (wb)	58	TC	45.5	45.5	51.9	41.8	41.8	47.9	37.9	37.9	43.7	33.9	33.9	39.4	29.7	29.7	34.9
			58	SHC	39.2	45.5	51.9	35.8	41.8	47.9	32.2	37.9	43.7	28.6	33.9	39.4	24.7	29.7	34.9
62			TC	45.5	45.5	54.0	41.8	41.8	49.9	38.0	38.0	45.6	34.0	34.0	41.2	29.8	29.8	36.7	
			SHC	37.1	45.5	54.0	33.7	41.8	49.9	30.3	38.0	45.6	26.7	34.0	41.2	23.0	29.8	36.7	
67			TC	46.7	46.7	54.6	42.6	42.6	51.7	38.3	38.3	48.7	34.1	34.1	44.6	29.8	29.8	40.1	
			SHC	31.7	43.1	54.6	29.0	40.4	51.7	26.2	37.4	48.7	23.0	33.8	44.6	19.7	29.8	40.1	
72		TC	52.0	52.0	52.0	47.6	47.6	47.6	42.9	42.9	42.9	38.1	38.1	38.1	33.2	33.2	33.5		
		SHC	21.2	32.8	44.4	18.5	30.1	41.7	15.9	27.5	39.1	13.3	24.8	36.4	10.5	22.0	33.5		
76		TC	—	56.7	56.7	—	52.2	52.2	—	47.3	47.3	—	42.3	42.3	—	37.1	37.1		
		SHC	—	24.2	35.8	—	21.5	33.2	—	18.9	30.5	—	16.3	27.8	—	13.6	25.1		
2500 CFM		EA (wb)	58	TC	46.9	46.9	53.4	43.1	43.1	49.3	39.2	39.2	45.0	35.1	35.1	40.6	30.8	30.8	36.0
			58	SHC	40.5	46.9	53.4	37.0	43.1	49.3	33.2	39.2	45.0	29.5	35.1	40.6	25.5	30.8	36.0
	62		TC	47.0	47.0	55.7	43.2	43.2	51.4	39.2	39.2	47.1	35.1	35.1	42.5	30.8	30.8	37.7	
			SHC	38.3	47.0	55.7	34.9	43.2	51.4	31.4	39.2	47.1	27.7	35.1	42.5	23.9	30.8	37.7	
	67		TC	47.5	47.5	58.3	43.5	43.5	54.6	39.4	39.4	50.7	35.1	35.1	46.2	30.8	30.8	41.2	
			SHC	33.5	45.9	58.3	30.5	42.5	54.6	27.4	39.0	50.7	24.1	35.1	46.2	20.5	30.8	41.2	
	72	TC	52.6	52.6	52.6	48.0	48.0	48.0	43.3	43.3	43.3	38.5	38.5	39.4	33.4	33.4	36.6		
		SHC	21.9	34.7	47.5	19.4	32.1	44.9	16.7	29.4	42.1	14.0	26.7	39.4	11.2	23.9	36.6		
	76	TC	—	57.3	57.3	—	52.7	52.7	—	47.8	47.8	—	42.7	42.7	—	37.4	37.4		
		SHC	—	25.2	38.0	—	22.6	35.4	—	19.9	32.7	—	17.3	29.9	—	14.4	27.1		

### LEGEND

- Do not operate
- CFM — Cubic feet per minute (supply air)
- EAT (db) — Entering Air Temperature (dry bulb)
- EAT (wb) — Entering Air Temperature (wet bulb)
- SHC — Sensible Heat Capacity (1000 Btuh) Gross
- TC — Total Capacity (1000 Btuh) Gross

**COOLING CAPACITIES - SECOND STAGE, PART LOAD (7.5 TONS)**

48LC SIZE 08			AMBIENT TEMPERATURE (°F)																
			85			95			105			115			125				
			EA (db)			EA (db)			EA (db)			EA (db)			EA (db)				
			75	80	85	75	80	85	75	80	85	75	80	85	75	80	85		
1500 CFM	EA (wb)	58	TC	45.7	45.7	52.3	42.4	42.4	48.7	39.0	39.0	44.9	35.3	35.3	41.0	31.5	31.5	37.0	
			SHC	39.2	45.7	52.3	36.2	42.4	48.7	33.0	39.0	44.9	29.6	35.3	41.0	26.1	31.5	37.0	
		62	TC	47.1	47.1	52.2	43.2	43.2	49.5	39.2	39.2	46.8	35.4	35.4	43.0	31.6	31.6	38.8	
			SHC	36.2	44.2	52.2	33.6	41.5	49.5	30.9	38.8	46.8	27.8	35.4	43.0	24.4	31.6	38.8	
		67	TC	53.1	53.1	53.1	48.8	48.8	48.8	44.5	44.5	44.5	40.0	40.0	40.0	35.2	35.2	35.2	
			SHC	29.3	37.2	45.2	26.6	34.7	42.7	24.0	32.1	40.1	21.4	29.3	37.3	18.6	26.6	34.6	
	72	TC	59.7	59.7	59.7	55.2	55.2	55.2	50.5	50.5	50.5	45.7	45.7	45.7	40.7	40.7	40.7		
		SHC	22.1	30.1	38.2	19.5	27.6	35.6	17.0	25.0	33.1	14.2	22.3	30.3	11.6	19.6	27.7		
	76	TC	—	65.3	65.3	—	60.6	60.6	—	55.8	55.8	—	50.7	50.7	—	45.3	45.3		
		SHC	—	24.4	32.4	—	21.8	29.8	—	19.2	27.3	—	16.6	24.6	—	13.8	21.9		
	1750 CFM	EA (wb)	58	TC	48.9	48.9	55.9	45.4	45.4	52.1	41.7	41.7	48.1	37.9	37.9	43.9	33.9	33.9	39.5
				SHC	42.1	48.9	55.9	38.8	45.4	52.1	35.5	41.7	48.1	32.0	37.9	43.9	28.3	33.9	39.5
62			TC	49.1	49.1	58.2	45.5	45.5	54.3	41.8	41.8	50.2	38.0	38.0	46.0	33.9	33.9	41.5	
			SHC	39.9	49.0	58.2	36.7	45.5	54.3	33.4	41.8	50.2	30.0	38.0	46.0	26.4	33.9	41.5	
67			TC	54.8	54.8	54.8	50.4	50.4	50.4	45.9	45.9	45.9	41.1	41.1	42.3	36.3	36.3	39.5	
			SHC	31.7	41.0	50.4	29.1	38.4	47.8	26.4	35.8	45.0	23.7	33.1	42.3	20.9	30.2	39.5	
72		TC	61.5	61.5	61.5	56.8	56.8	56.8	52.0	52.0	52.0	47.0	47.0	47.0	41.7	41.7	41.7		
		SHC	23.3	32.7	42.0	20.7	30.0	39.5	18.0	27.4	36.8	15.3	24.7	34.0	12.6	21.9	31.3		
76		TC	—	67.3	67.3	—	62.3	62.3	—	57.2	57.2	—	52.0	52.0	—	46.5	46.5		
		SHC	—	25.8	35.2	—	23.2	32.7	—	20.6	29.9	—	17.9	27.3	—	15.1	24.6		
2000 CFM		EA (wb)	58	TC	51.7	51.7	58.9	48.0	48.0	54.8	44.1	44.1	50.6	40.1	40.1	46.3	35.9	35.9	41.7
				SHC	44.5	51.7	58.9	41.0	48.0	54.8	37.5	44.1	50.6	33.8	40.1	46.3	30.0	35.9	41.7
	62		TC	51.8	51.8	61.3	48.1	48.1	57.2	44.2	44.2	52.9	40.2	40.2	48.5	35.9	35.9	43.7	
			SHC	42.2	51.8	61.3	38.8	48.1	57.2	35.4	44.2	52.9	31.8	40.2	48.5	28.1	35.9	43.7	
	67		TC	56.2	56.2	56.2	51.6	51.6	52.7	47.0	47.0	49.9	42.1	42.1	47.1	37.1	37.1	44.2	
			SHC	34.1	44.7	55.3	31.4	42.0	52.7	28.7	39.3	49.9	25.9	36.5	47.1	23.1	33.6	44.2	
	72	TC	62.8	62.8	62.8	58.0	58.0	58.0	53.0	53.0	53.0	47.9	47.9	47.9	42.5	42.5	42.5		
		SHC	24.4	35.1	45.7	21.7	32.4	43.1	19.0	29.7	40.4	16.3	27.0	37.6	13.5	24.2	34.8		
	76	TC	—	68.6	68.6	—	63.6	63.6	—	58.4	58.4	—	52.9	52.9	—	47.3	47.3		
		SHC	—	27.2	37.9	—	24.6	35.3	—	21.9	32.7	—	19.2	29.8	—	16.4	27.1		
	2250 CFM	EA (wb)	58	TC	53.9	53.9	61.3	50.1	50.1	57.1	46.0	46.0	52.8	41.8	41.8	48.3	37.4	37.4	43.5
				SHC	46.5	53.9	61.3	43.0	50.1	57.1	39.3	46.0	52.8	35.5	41.8	48.3	31.5	37.4	43.5
62			TC	54.0	54.0	64.0	50.1	50.1	59.7	46.1	46.1	55.2	41.9	41.9	50.5	37.5	37.5	45.5	
			SHC	44.1	54.0	64.0	40.7	50.1	59.7	37.1	46.1	55.2	33.3	41.9	50.5	29.4	37.5	45.5	
67			TC	57.2	57.2	60.1	52.6	52.6	57.3	47.9	47.9	54.6	43.0	43.0	51.7	37.9	37.9	48.6	
			SHC	36.4	48.3	60.1	33.6	45.5	57.3	30.9	42.7	54.6	28.1	39.9	51.7	25.2	36.9	48.6	
72		TC	63.9	63.9	63.9	59.0	59.0	59.0	53.9	53.9	53.9	48.7	48.7	48.7	43.1	43.1	43.1		
		SHC	25.4	37.3	49.3	22.7	34.6	46.6	20.0	31.9	43.9	17.3	29.2	41.0	14.4	26.3	38.2		
76		TC	—	69.7	69.7	—	64.5	64.5	—	59.2	59.2	—	53.7	53.7	—	48.0	48.0		
		SHC	—	28.5	40.5	—	25.8	37.8	—	23.1	35.1	—	20.4	32.3	—	17.6	29.4		
2500 CFM		EA (wb)	58	TC	55.9	55.9	63.6	51.9	51.9	59.2	47.7	47.7	54.7	43.4	43.4	50.0	38.8	38.8	45.0
				SHC	48.3	55.9	63.6	44.6	51.9	59.2	40.8	47.7	54.7	36.9	43.4	50.0	32.7	38.8	45.0
	62		TC	56.0	56.0	66.2	52.0	52.0	61.7	47.8	47.8	57.0	43.5	43.5	52.3	38.9	38.9	47.2	
			SHC	45.7	56.0	66.2	42.2	52.0	61.7	38.5	47.8	57.0	34.7	43.5	52.3	30.6	38.9	47.2	
	67		TC	58.1	58.1	64.7	53.4	53.4	61.9	48.7	48.7	58.9	44.0	44.0	55.2	39.1	39.1	50.9	
			SHC	38.5	51.6	64.7	35.8	48.8	61.9	33.0	45.9	58.9	29.8	42.5	55.2	26.4	38.7	50.9	
	72	TC	64.7	64.7	64.7	59.7	59.7	59.7	54.5	54.5	54.5	49.1	49.1	49.1	43.6	43.6	43.6		
		SHC	26.3	39.5	52.7	23.6	36.9	50.0	20.9	34.0	47.3	18.0	31.3	44.5	15.2	28.4	41.5		
	76	TC	—	70.6	70.6	—	65.3	65.3	—	60.0	60.0	—	54.3	54.3	—	48.5	48.5		
		SHC	—	29.6	42.9	—	27.0	40.3	—	24.2	37.4	—	21.5	34.6	—	18.6	31.8		

**LEGEND**

- Do not operate
- CFM — Cubic feet per minute (supply air)
- EAT (db) — Entering Air Temperature (dry bulb)
- EAT (wb) — Entering Air Temperature (wet bulb)
- SHC — Sensible Heat Capacity (1000 Btuh) Gross
- TC — Total Capacity (1000 Btuh) Gross

## COOLING CAPACITIES - THIRD STAGE, FULL LOAD (7.5 TONS)

48LC SIZE 08			AMBIENT TEMPERATURE (°F)																
			85			95			105			115			125				
			EA (db)			EA (db)			EA (db)			EA (db)			EA (db)				
			75	80	85	75	80	85	75	80	85	75	80	85	75	80	85		
2250 CFM	EA (wb)	58	TC	77.4	77.4	88.3	72.3	72.3	82.9	67.0	67.0	77.1	61.4	61.4	71.0	55.6	55.6	64.6	
		SHC	66.5	77.4	88.3	61.8	72.3	82.9	56.9	67.0	77.1	51.9	61.4	71.0	46.5	55.6	64.6		
		62	TC	82.3	82.3	83.8	76.1	76.1	79.8	69.6	69.6	75.7	63.0	63.0	71.5	56.1	56.1	67.1	
		SHC	59.8	71.8	83.8	55.8	67.8	79.8	51.7	63.7	75.7	47.6	59.5	71.5	43.2	55.2	67.1		
		67	TC	92.3	92.3	92.3	85.7	85.7	85.7	78.8	78.8	78.8	71.5	71.5	71.5	64.0	64.0	64.0	
		SHC	49.2	61.2	73.2	45.2	57.2	69.2	41.1	53.1	65.1	37.0	49.0	61.0	32.8	44.8	56.7		
	72	TC	103.3	103.3	103.3	96.1	96.1	96.1	88.7	88.7	88.7	81.0	81.0	81.0	72.9	72.9	72.9		
	SHC	38.4	50.5	62.5	34.4	46.5	58.6	30.4	42.4	54.5	26.2	38.3	50.4	22.0	34.0	46.1			
	76	TC	—	112.4	112.4	—	104.9	104.9	—	97.1	97.1	—	89.0	89.0	—	80.4	80.4		
	SHC	—	41.6	53.6	—	37.6	49.7	—	33.6	45.6	—	29.4	41.5	—	25.3	37.3			
	2650 CFM	EA (wb)	58	TC	83.5	83.5	95.1	78.0	78.0	89.1	72.2	72.2	83.0	66.3	66.3	76.4	60.1	60.1	69.6
			SHC	71.9	83.5	95.1	66.9	78.0	89.1	61.6	72.2	83.0	56.2	66.3	76.4	50.5	60.1	69.6	
62			TC	85.9	85.9	94.1	79.5	79.5	89.9	72.8	72.8	85.6	66.4	66.4	80.0	60.2	60.2	72.9	
SHC			66.0	80.0	94.1	61.9	76.0	89.9	57.7	71.7	85.6	52.8	66.4	80.0	47.4	60.2	72.9		
67			TC	95.8	95.8	95.8	88.8	88.8	88.8	81.6	81.6	81.6	74.0	74.0	74.0	66.2	66.2	66.2	
SHC			53.3	67.5	81.6	49.2	63.4	77.5	45.1	59.2	73.3	40.9	55.0	69.0	36.6	50.6	64.6		
72		TC	106.9	106.9	106.9	99.4	99.4	99.4	91.7	91.7	91.7	83.6	83.6	83.6	75.1	75.1	75.1		
SHC		40.5	54.6	68.8	36.4	50.5	64.7	32.3	46.4	60.5	28.0	42.2	56.4	23.7	37.8	52.0			
76		TC	—	116.1	116.1	—	108.2	108.2	—	100.0	100.0	—	91.6	91.6	—	82.7	82.7		
SHC		—	44.1	58.2	—	40.0	54.2	—	35.9	50.1	—	31.7	45.9	—	27.4	41.6			
3000 CFM		EA (wb)	58	TC	87.9	87.9	100.0	82.1	82.1	93.8	76.1	76.1	87.3	69.8	69.8	80.3	63.3	63.3	73.2
			SHC	75.8	87.9	100.0	70.5	82.1	93.8	65.0	76.1	87.3	59.3	69.8	80.3	53.3	63.3	73.2	
	62		TC	88.6	88.6	102.6	82.3	82.3	97.7	76.2	76.2	91.1	70.0	70.0	84.0	63.4	63.4	76.6	
	SHC		71.2	86.9	102.6	66.7	82.2	97.7	61.4	76.2	91.1	55.9	70.0	84.0	50.1	63.4	76.6		
	67		TC	98.2	98.2	98.2	91.0	91.0	91.0	83.5	83.5	83.5	75.8	75.8	75.9	67.7	67.7	71.4	
	SHC		56.7	72.6	88.5	52.7	68.5	84.4	48.4	64.3	80.1	44.1	60.0	75.9	39.7	55.5	71.4		
	72	TC	109.2	109.2	109.2	101.6	101.6	101.6	93.6	93.6	93.6	85.2	85.2	85.2	76.5	76.5	76.5		
	SHC	42.0	58.0	74.0	37.9	53.9	69.8	33.7	49.6	65.6	29.4	45.3	61.3	25.1	41.0	56.9			
	76	TC	—	118.5	118.5	—	110.4	110.4	—	102.0	102.0	—	93.2	93.2	—	84.0	84.0		
	SHC	—	45.9	62.0	—	41.9	58.0	—	37.7	53.7	—	33.4	49.4	—	29.1	45.0			
	3400 CFM	EA (wb)	58	TC	92.2	92.2	104.8	86.2	86.2	98.2	79.9	79.9	91.4	73.3	73.3	84.1	66.4	66.4	76.6
			SHC	79.7	92.2	104.8	74.1	86.2	98.2	68.3	79.9	91.4	62.4	73.3	84.1	56.1	66.4	76.6	
62			TC	92.3	92.3	109.2	86.3	86.3	102.4	80.0	80.0	95.4	73.4	73.4	87.9	66.5	66.5	80.1	
SHC			75.6	92.3	109.2	70.2	86.3	102.4	64.5	80.0	95.4	58.8	73.4	87.9	52.7	66.5	80.1		
67			TC	100.3	100.3	100.3	92.9	92.9	92.9	85.2	85.2	87.8	77.3	77.3	83.4	69.1	69.1	78.7	
SHC			60.5	78.4	96.2	56.3	74.2	92.0	52.0	69.8	87.8	47.6	65.4	83.4	43.1	60.9	78.7		
72		TC	111.3	111.3	111.3	103.4	103.4	103.4	95.3	95.3	95.3	86.7	86.7	86.7	77.8	77.8	77.8		
SHC		43.7	61.6	79.7	39.5	57.5	75.5	35.3	53.2	71.2	30.9	48.8	66.8	26.5	44.5	62.3			
76		TC	—	120.6	120.6	—	112.3	112.3	—	103.6	103.6	—	94.7	94.7	—	85.2	85.2		
SHC		—	48.0	66.1	—	43.9	61.9	—	39.6	57.6	—	35.3	53.2	—	30.8	48.7			
3750 CFM		EA (wb)	58	TC	95.5	95.5	108.4	89.2	89.2	101.6	82.7	82.7	94.5	75.9	75.9	87.0	68.6	68.6	79.2
			SHC	82.5	95.5	108.4	76.7	89.2	101.6	70.8	82.7	94.5	64.6	75.9	87.0	58.1	68.6	79.2	
	62		TC	95.6	95.6	112.9	89.3	89.3	105.9	82.8	82.8	98.6	76.0	76.0	90.9	68.7	68.7	82.9	
	SHC		78.3	95.6	112.9	72.7	89.3	105.9	67.0	82.8	98.6	60.9	76.0	90.9	54.7	68.7	82.9		
	67		TC	101.9	101.9	102.9	94.4	94.4	98.6	86.6	86.6	94.2	78.5	78.5	89.6	70.2	70.2	84.9	
	SHC		63.5	83.2	102.9	59.3	78.9	98.6	55.0	74.6	94.2	50.5	70.1	89.6	46.0	65.4	84.9		
	72	TC	112.8	112.8	112.8	104.8	104.8	104.8	96.4	96.4	96.4	87.8	87.8	87.8	78.7	78.7	78.7		
	SHC	44.9	64.7	84.4	40.8	60.5	80.2	36.6	56.2	75.9	32.2	51.8	71.5	27.7	47.3	67.0			
	76	TC	—	122.1	122.1	—	113.6	113.6	—	104.7	104.7	—	95.6	95.6	—	86.0	86.0		
	SHC	—	49.6	69.4	—	45.4	65.2	—	41.1	60.8	—	36.8	56.4	—	32.2	51.6			

### LEGEND

- Do not operate
- CFM — Cubic feet per minute (supply air)
- EAT (db) — Entering Air Temperature (dry bulb)
- EAT (wb) — Entering Air Temperature (wet bulb)
- SHC — Sensible Heat Capacity (1000 Btuh) Gross
- TC — Total Capacity (1000 Btuh) Gross



**COOLING CAPACITIES - FIRST STAGE, PART LOAD (8.5 TONS)**

48LC SIZE 09			AMBIENT TEMPERATURE (°F)																
			85			95			105			115			125				
			EA (db)			EA (db)			EA (db)			EA (db)			EA (db)				
			75	80	85	75	80	85	75	80	85	75	80	85	75	80	85		
1700 CFM	EA (wb)	58	TC	45.6	45.6	51.5	43.5	43.5	49.1	41.2	41.2	46.6	38.8	38.8	43.9	36.3	36.3	41.0	
			SHC	39.7	45.6	51.5	37.8	43.5	49.1	35.8	41.2	46.6	33.6	38.8	43.9	31.4	36.3	41.0	
		62	TC	45.6	45.6	53.5	43.5	43.5	51.1	41.2	41.2	48.5	38.8	38.8	45.7	36.3	36.3	42.7	
			SHC	37.7	45.6	53.5	36.0	43.5	51.1	34.0	41.2	48.5	32.0	38.8	45.7	29.8	36.3	42.7	
		67	TC	48.8	48.8	48.8	46.0	46.0	47.6	43.2	43.2	46.3	40.2	40.2	44.9	37.1	37.1	43.4	
			SHC	31.0	39.9	48.8	29.7	38.6	47.6	28.5	37.3	46.3	27.1	36.0	44.9	25.7	34.5	43.4	
	72	TC	53.7	53.7	53.7	50.8	50.8	50.8	47.8	47.8	47.8	44.5	44.5	44.5	41.0	41.0	41.0		
		SHC	22.3	31.3	40.3	21.1	30.1	39.1	19.8	28.9	37.8	18.5	27.5	36.5	17.2	26.1	35.1		
	76	TC	—	58.1	58.1	—	55.0	55.0	—	51.8	51.8	—	48.3	48.3	—	44.7	44.7		
		SHC	—	24.3	33.3	—	23.1	32.2	—	21.8	30.9	—	20.6	29.5	—	19.2	28.3		
	2000 CFM	EA (wb)	58	TC	47.9	47.9	54.0	45.5	45.5	51.5	43.2	43.2	48.8	40.6	40.6	45.9	37.8	37.8	42.9
				SHC	41.6	47.9	54.0	39.7	45.5	51.5	37.5	43.2	48.8	35.2	40.6	45.9	32.9	37.8	42.9
62			TC	47.9	47.9	56.2	45.6	45.6	53.5	43.2	43.2	50.7	40.7	40.7	47.8	37.9	37.9	44.7	
			SHC	39.7	47.9	56.2	37.7	45.6	53.5	35.7	43.2	50.7	33.4	40.7	47.8	31.2	37.9	44.7	
67			TC	49.7	49.7	54.2	47.0	47.0	52.8	44.1	44.1	51.5	41.0	41.0	49.9	38.0	38.0	47.9	
			SHC	33.4	43.8	54.2	32.2	42.5	52.8	30.8	41.1	51.5	29.4	39.7	49.9	27.8	37.8	47.9	
72		TC	54.7	54.7	54.7	51.8	51.8	51.8	48.6	48.6	48.6	45.2	45.2	45.2	41.7	41.7	41.7		
		SHC	23.3	33.8	44.3	22.1	32.6	43.1	20.9	31.3	41.7	19.5	29.9	40.5	18.1	28.6	39.1		
76		TC	—	59.1	59.1	—	56.0	56.0	—	52.6	52.6	—	49.0	49.0	—	45.3	45.3		
		SHC	—	25.5	36.2	—	24.4	34.9	—	23.1	33.6	—	21.8	32.4	—	20.5	30.9		
2250 CFM		EA (wb)	58	TC	49.3	49.3	55.8	47.0	47.0	53.1	44.5	44.5	50.3	41.8	41.8	47.3	39.0	39.0	44.2
				SHC	43.0	49.3	55.8	41.0	47.0	53.1	38.7	44.5	50.3	36.3	41.8	47.3	33.8	39.0	44.2
	62		TC	49.4	49.4	57.9	47.1	47.1	55.2	44.6	44.6	52.3	41.8	41.8	49.1	39.0	39.0	45.9	
			SHC	41.0	49.4	57.9	38.9	47.1	55.2	36.8	44.6	52.3	34.5	41.8	49.1	32.1	39.0	45.9	
	67		TC	50.5	50.5	58.4	47.7	47.7	56.9	44.8	44.8	55.3	41.9	41.9	52.7	39.0	39.0	49.4	
			SHC	35.3	46.9	58.4	34.0	45.4	56.9	32.6	43.9	55.3	30.8	41.8	52.7	28.7	39.0	49.4	
	72	TC	55.4	55.4	55.4	52.3	52.3	52.3	49.0	49.0	49.0	45.6	45.6	45.6	42.1	42.1	42.2		
		SHC	24.1	35.8	47.5	22.9	34.6	46.2	21.6	33.2	44.9	20.3	32.0	43.6	18.9	30.5	42.2		
	76	TC	—	59.8	59.8	—	56.6	56.6	—	53.1	53.1	—	49.4	49.4	—	45.7	45.7		
		SHC	—	26.6	38.4	—	25.4	37.1	—	24.2	35.9	—	22.8	34.5	—	21.5	33.2		
	2550 CFM	EA (wb)	58	TC	50.9	50.9	57.4	48.5	48.5	54.7	45.8	45.8	51.8	43.0	43.0	48.7	40.1	40.1	45.3
				SHC	44.4	50.9	57.4	42.2	48.5	54.7	39.9	45.8	51.8	37.3	43.0	48.7	34.7	40.1	45.3
62			TC	51.0	51.0	59.7	48.5	48.5	56.8	45.8	45.8	53.8	43.0	43.0	50.6	40.1	40.1	47.2	
			SHC	42.2	51.0	59.7	40.1	48.5	56.8	37.8	45.8	53.8	35.5	43.0	50.6	33.0	40.1	47.2	
67			TC	51.3	51.3	62.9	48.6	48.6	60.8	45.9	45.9	57.4	43.1	43.1	54.4	40.1	40.1	50.7	
			SHC	37.4	50.1	62.9	35.9	48.4	60.8	33.8	45.6	57.4	31.8	43.1	54.4	29.5	40.1	50.7	
72		TC	55.9	55.9	55.9	52.8	52.8	52.8	49.5	49.5	49.5	46.0	46.0	47.3	42.4	42.4	45.8		
		SHC	25.0	38.1	51.2	23.8	36.9	49.9	22.5	35.6	48.7	21.2	34.2	47.3	19.8	32.8	45.8		
76		TC	—	60.4	60.4	—	57.0	57.0	—	53.6	53.6	—	49.9	49.9	—	46.0	46.0		
		SHC	—	27.8	41.0	—	26.6	39.7	—	25.4	38.4	—	24.0	37.1	—	22.6	35.7		
2800 CFM		EA (wb)	58	TC	52.0	52.0	58.7	49.4	49.4	55.9	46.7	46.7	52.8	43.9	43.9	49.6	40.9	40.9	46.2
				SHC	45.3	52.0	58.7	43.1	49.4	55.9	40.7	46.7	52.8	38.1	43.9	49.6	35.4	40.9	46.2
	62		TC	52.1	52.1	60.9	49.5	49.5	58.0	46.8	46.8	54.9	43.9	43.9	51.6	40.9	40.9	48.1	
			SHC	43.1	52.1	60.9	41.0	49.5	58.0	38.6	46.8	54.9	36.2	43.9	51.6	33.6	40.9	48.1	
	67		TC	52.2	52.2	65.1	49.6	49.6	61.9	46.8	46.8	59.0	44.0	44.0	55.5	40.9	40.9	51.7	
			SHC	38.6	51.9	65.1	36.6	49.2	61.9	34.6	46.8	59.0	32.5	44.0	55.5	30.1	40.9	51.7	
	72	TC	56.3	56.3	56.3	53.1	53.1	53.1	49.8	49.8	51.6	46.3	46.3	50.2	42.7	42.7	48.8		
		SHC	25.7	40.0	54.2	24.5	38.7	52.9	23.2	37.4	51.6	21.8	36.1	50.2	20.5	34.6	48.8		
	76	TC	—	60.7	60.7	—	57.4	57.4	—	53.9	53.9	—	50.2	50.2	—	46.3	46.3		
		SHC	—	28.8	43.1	—	27.5	41.8	—	26.2	40.5	—	24.9	39.1	—	23.5	37.7		

**LEGEND**

- Do not operate
- CFM — Cubic feet per minute (supply air)
- EAT (db) — Entering Air Temperature (dry bulb)
- EAT (wb) — Entering Air Temperature (wet bulb)
- SHC — Sensible Heat Capacity (1000 Btuh) Gross
- TC — Total Capacity (1000 Btuh) Gross



## COOLING CAPACITIES - SECOND STAGE, PART LOAD (8.5 TONS)

48LC SIZE 09			AMBIENT TEMPERATURE (°F)																
			85			95			105			115			125				
			EA (db)			EA (db)			EA (db)			EA (db)			EA (db)				
			75	80	85	75	80	85	75	80	85	75	80	85	75	80	85		
1700 CFM	EA (wb)	58	TC	57.8	57.8	65.3	55.3	55.3	62.6	52.7	52.7	59.7	49.8	49.8	56.5	46.7	46.7	53.0	
		58	SHC	50.2	57.8	65.3	48.0	55.3	62.6	45.6	52.7	59.7	43.1	49.8	56.5	40.4	46.7	53.0	
		62	TC	59.7	59.7	64.0	56.6	56.6	62.2	53.4	53.4	60.5	50.0	50.0	58.4	46.8	46.8	55.3	
			SHC	46.0	55.0	64.0	44.4	53.3	62.2	42.6	51.5	60.5	40.8	49.5	58.4	38.2	46.8	55.3	
		67	TC	65.8	65.8	65.8	62.5	62.5	62.5	59.0	59.0	59.0	55.2	55.2	55.2	51.2	51.2	51.2	
			SHC	37.5	46.6	55.6	36.0	44.9	53.9	34.2	43.2	52.3	32.5	41.4	50.4	30.5	39.5	48.6	
	72	TC	72.6	72.6	72.6	69.1	69.1	69.1	65.3	65.3	65.3	61.3	61.3	61.3	56.9	56.9	56.9		
		SHC	29.0	37.9	47.0	27.3	36.4	45.4	25.6	34.6	43.7	23.9	32.9	41.9	21.9	31.0	40.1		
	76	TC	—	78.6	78.6	—	74.9	74.9	—	70.8	70.8	—	66.5	66.5	—	61.9	61.9		
		SHC	—	30.9	40.0	—	29.3	38.4	—	27.6	36.8	—	25.8	35.0	—	24.1	33.2		
	2000 CFM	EA (wb)	58	TC	61.2	61.2	69.2	58.6	58.6	66.3	55.8	55.8	63.1	52.7	52.7	59.8	49.3	49.3	56.1
			58	SHC	53.3	61.2	69.2	50.9	58.6	66.3	48.4	55.8	63.1	45.6	52.7	59.8	42.7	49.3	56.1
62			TC	61.8	61.8	70.8	58.8	58.8	68.7	55.8	55.8	65.7	52.7	52.7	62.2	49.4	49.4	58.3	
			SHC	50.1	60.5	70.8	48.3	58.5	68.7	45.9	55.8	65.7	43.3	52.7	62.2	40.5	49.4	58.3	
67			TC	67.7	67.7	67.7	64.3	64.3	64.3	60.5	60.5	60.5	56.6	56.6	56.6	52.5	52.5	54.0	
			SHC	40.3	50.8	61.3	38.6	49.1	59.7	36.9	47.4	57.9	35.1	45.5	56.1	33.2	43.6	54.0	
72		TC	74.7	74.7	74.7	71.0	71.0	71.0	67.0	67.0	67.0	62.8	62.8	62.8	58.2	58.2	58.2		
		SHC	30.1	40.7	51.3	28.5	39.0	49.6	26.7	37.3	47.9	25.0	35.5	46.0	23.1	33.6	44.2		
76		TC	—	80.6	80.6	—	76.7	76.7	—	72.5	72.5	—	68.1	68.1	—	63.2	63.2		
		SHC	—	32.5	43.1	—	30.8	41.4	—	29.1	39.8	—	27.3	37.9	—	25.4	36.1		
2250 CFM		EA (wb)	58	TC	63.7	63.7	72.0	60.8	60.8	68.8	57.9	57.9	65.5	54.7	54.7	62.0	51.2	51.2	58.1
			58	SHC	55.5	63.7	72.0	52.9	60.8	68.8	50.2	57.9	65.5	47.4	54.7	62.0	44.3	51.2	58.1
	62		TC	63.8	63.8	74.9	60.9	60.9	71.6	58.0	58.0	68.2	54.8	54.8	64.4	51.3	51.3	60.5	
			SHC	52.7	63.8	74.9	50.3	60.9	71.6	47.8	58.0	68.2	45.0	54.8	64.4	42.0	51.3	60.5	
	67		TC	68.9	68.9	68.9	65.3	65.3	65.3	61.6	61.6	62.4	57.6	57.6	60.5	53.3	53.3	58.5	
			SHC	42.4	54.2	65.9	40.8	52.5	64.3	39.0	50.7	62.4	37.1	48.8	60.5	35.2	46.8	58.5	
	72	TC	76.0	76.0	76.0	72.1	72.1	72.1	68.1	68.1	68.1	63.7	63.7	63.7	59.1	59.1	59.1		
		SHC	31.0	42.8	54.7	29.3	41.1	52.9	27.7	39.4	51.2	25.8	37.6	49.3	23.9	35.7	47.4		
	76	TC	—	82.0	82.0	—	77.9	77.9	—	73.6	73.6	—	69.0	69.0	—	64.1	64.1		
		SHC	—	33.6	45.5	—	32.0	43.9	—	30.2	42.1	—	28.4	40.3	—	26.5	38.3		
	2550 CFM	EA (wb)	58	TC	66.2	66.2	74.8	63.2	63.2	71.5	60.1	60.1	68.0	56.7	56.7	64.3	53.0	53.0	60.2
			58	SHC	57.6	66.2	74.8	55.0	63.2	71.5	52.2	60.1	68.0	49.1	56.7	64.3	45.9	53.0	60.2
62			TC	66.3	66.3	77.7	63.3	63.3	74.3	60.2	60.2	70.7	56.7	56.7	66.9	53.1	53.1	62.7	
			SHC	54.8	66.3	77.7	52.3	63.3	74.3	49.6	60.2	70.7	46.7	56.7	66.9	43.6	53.1	62.7	
67			TC	70.1	70.1	71.2	66.5	66.5	69.5	62.6	62.6	67.7	58.6	58.6	65.6	54.2	54.2	63.5	
			SHC	44.9	58.0	71.2	43.2	56.4	69.5	41.3	54.5	67.7	39.5	52.6	65.6	37.4	50.5	63.5	
72		TC	77.1	77.1	77.1	73.1	73.1	73.1	69.0	69.0	69.0	64.5	64.5	64.5	59.9	59.9	59.9		
		SHC	32.1	45.3	58.5	30.4	43.6	56.8	28.7	41.8	55.1	26.8	40.0	53.2	24.9	38.0	51.3		
76		TC	—	83.3	83.3	—	79.1	79.1	—	74.6	74.6	—	69.9	69.9	—	64.8	64.8		
		SHC	—	34.9	48.3	—	33.2	46.5	—	31.5	44.8	—	29.6	42.9	—	27.8	41.0		
2800 CFM		EA (wb)	58	TC	68.0	68.0	76.7	64.9	64.9	73.3	61.6	61.6	69.7	58.2	58.2	65.9	54.4	54.4	61.7
			58	SHC	59.2	68.0	76.7	56.5	64.9	73.3	53.5	61.6	69.7	50.5	58.2	65.9	47.1	54.4	61.7
	62		TC	68.1	68.1	79.8	64.9	64.9	76.2	61.7	61.7	72.5	58.2	58.2	68.5	54.4	54.4	64.2	
			SHC	56.3	68.1	79.8	53.6	64.9	76.2	50.9	61.7	72.5	48.0	58.2	68.5	44.8	54.4	64.2	
	67		TC	71.0	71.0	75.5	67.3	67.3	73.7	63.4	63.4	71.8	59.3	59.3	69.7	54.9	54.9	67.3	
			SHC	46.9	61.1	75.5	45.1	59.4	73.7	43.3	57.5	71.8	41.3	55.5	69.7	39.2	53.2	67.3	
	72	TC	77.9	77.9	77.9	73.9	73.9	73.9	69.7	69.7	69.7	65.1	65.1	65.1	60.4	60.4	60.4		
		SHC	32.9	47.3	61.7	31.2	45.5	60.0	29.4	43.8	58.2	27.6	41.9	56.3	25.6	40.0	54.3		
	76	TC	—	84.0	84.0	—	79.8	79.8	—	75.3	75.3	—	70.5	70.5	—	65.3	65.3		
		SHC	—	36.0	50.4	—	34.2	48.8	—	32.5	46.9	—	30.6	45.0	—	28.7	43.0		

### LEGEND

- Do not operate
- CFM — Cubic feet per minute (supply air)
- EAT (db) — Entering Air Temperature (dry bulb)
- EAT (wb) — Entering Air Temperature (wet bulb)
- SHC — Sensible Heat Capacity (1000 Btuh) Gross
- TC — Total Capacity (1000 Btuh) Gross



### COOLING CAPACITIES - THIRD STAGE, FULL LOAD (8.5 TONS)

48LC SIZE 09			AMBIENT TEMPERATURE (°F)																
			85			95			105			115			125				
			EA (db)			EA (db)			EA (db)			EA (db)			EA (db)				
			75	80	85	75	80	85	75	80	85	75	80	85	75	80	85		
2250 CFM	EA (wb)	58	TC	89.1	89.1	101.2	84.4	84.4	96.1	79.5	79.5	90.7	74.2	74.2	84.9	68.6	68.6	78.9	
			SHC	77.0	89.1	101.2	72.8	84.4	96.1	68.3	79.5	90.7	63.6	74.2	84.9	58.5	68.6	78.9	
		62	TC	93.6	93.6	96.3	87.9	87.9	92.9	81.9	81.9	89.3	75.7	75.7	85.5	69.1	69.1	81.4	
			SHC	69.4	82.9	96.3	66.0	79.5	92.9	62.4	75.9	89.3	58.7	72.1	85.5	54.8	68.1	81.4	
		67	TC	103.5	103.5	103.5	97.5	97.5	97.5	91.1	91.1	91.1	84.3	84.3	84.3	77.1	77.1	77.1	
			SHC	56.8	70.4	83.9	53.4	67.0	80.5	49.9	63.5	76.9	46.3	59.8	73.3	42.5	56.0	69.5	
	72	TC	114.6	114.6	114.6	108.1	108.1	108.1	101.2	101.2	101.2	94.0	94.0	94.0	86.3	86.3	86.3		
		SHC	44.1	57.7	71.3	40.8	54.3	67.9	37.2	50.8	64.4	33.6	47.2	60.7	29.8	43.4	56.9		
	76	TC	—	124.0	124.0	—	117.2	117.2	—	110.0	110.0	—	102.3	102.3	—	94.1	94.1		
		SHC	—	47.3	60.9	—	43.9	57.6	—	40.5	54.1	—	36.9	50.5	—	33.2	46.8		
	3000 CFM	EA (wb)	58	TC	95.2	95.2	107.9	90.1	90.1	102.4	84.8	84.8	96.6	79.2	79.2	90.5	73.2	73.2	83.9
				SHC	82.4	95.2	107.9	77.8	90.1	102.4	72.9	84.8	96.6	67.9	79.2	90.5	62.5	73.2	83.9
62			TC	97.1	97.1	107.3	91.3	91.3	103.7	85.2	85.2	99.7	79.4	79.4	94.4	73.3	73.3	87.6	
			SHC	76.0	91.7	107.3	72.4	88.0	103.7	68.6	84.1	99.7	64.3	79.3	94.4	59.0	73.3	87.6	
67			TC	106.9	106.9	106.9	100.5	100.5	100.5	93.8	93.8	93.8	86.8	86.8	86.8	79.4	79.4	79.4	
			SHC	61.1	76.9	92.7	57.7	73.5	89.3	54.1	69.8	85.6	50.3	66.1	81.9	46.5	62.2	78.0	
72		TC	118.0	118.0	118.0	111.2	111.2	111.2	104.0	104.0	104.0	96.5	96.5	96.5	88.5	88.5	88.5		
		SHC	46.1	61.9	77.8	42.6	58.5	74.4	39.1	54.9	70.8	35.4	51.2	67.1	31.6	47.4	63.2		
76		TC	—	127.5	127.5	—	120.3	120.3	—	112.8	112.8	—	104.7	104.7	—	96.2	96.2		
		SHC	—	49.7	65.8	—	46.3	62.4	—	42.8	58.8	—	39.1	55.0	—	35.2	51.1		
3400 CFM		EA (wb)	58	TC	99.5	99.5	112.8	94.3	94.3	107.1	88.7	88.7	100.9	82.8	82.8	94.5	76.5	76.5	87.7
				SHC	86.2	99.5	112.8	81.4	94.3	107.1	76.4	88.7	100.9	71.1	82.8	94.5	65.4	76.5	87.7
	62		TC	99.9	99.9	116.3	94.4	94.4	111.5	88.8	88.8	105.2	82.9	82.9	98.6	76.6	76.6	91.5	
			SHC	81.3	98.9	116.3	77.3	94.4	111.5	72.4	88.8	105.2	67.3	82.9	98.6	61.8	76.6	91.5	
	67		TC	109.1	109.1	109.1	102.6	102.6	102.6	95.7	95.7	95.7	88.4	88.4	89.2	80.8	80.8	85.2	
			SHC	64.7	82.5	100.3	61.2	79.0	96.7	57.5	75.3	93.0	53.8	71.5	89.2	49.9	67.6	85.2	
	72	TC	120.3	120.3	120.3	113.3	113.3	113.3	106.0	106.0	106.0	98.2	98.2	98.2	90.0	90.0	90.0		
		SHC	47.7	65.5	83.4	44.2	62.0	79.8	40.6	58.4	76.1	36.9	54.6	72.3	33.1	50.7	68.4		
	76	TC	—	129.9	129.9	—	122.5	122.5	—	114.7	114.7	—	106.4	106.4	—	97.6	97.6		
		SHC	—	51.7	69.7	—	48.3	66.2	—	44.6	62.5	—	40.9	58.6	—	37.0	54.6		
	3850 CFM	EA (wb)	58	TC	103.7	103.7	117.5	98.2	98.2	111.4	92.3	92.3	105.1	86.2	86.2	98.3	79.7	79.7	91.1
				SHC	89.9	103.7	117.5	84.9	98.2	111.4	79.7	92.3	105.1	74.1	86.2	98.3	68.3	79.7	91.1
62			TC	103.8	103.8	122.3	98.3	98.3	116.0	92.4	92.4	109.4	86.3	86.3	102.4	79.8	79.8	95.0	
			SHC	85.4	103.8	122.3	80.5	98.3	116.0	75.5	92.4	109.4	70.1	86.3	102.4	64.4	79.8	95.0	
67			TC	111.2	111.2	111.2	104.5	104.5	104.8	97.4	97.4	101.0	90.1	90.1	97.1	82.3	82.3	93.0	
			SHC	68.5	88.5	108.4	65.0	84.9	104.8	61.2	81.1	101.0	57.4	77.3	97.1	53.5	73.2	93.0	
72		TC	122.3	122.3	122.3	115.1	115.1	115.1	107.6	107.6	107.6	99.6	99.6	99.6	91.4	91.4	91.4		
		SHC	49.3	69.2	89.2	45.8	65.7	85.7	42.1	62.1	82.0	38.4	58.2	78.1	34.5	54.3	74.1		
76		TC	—	131.9	131.9	—	124.3	124.3	—	116.2	116.2	—	107.7	107.7	—	98.7	98.7		
		SHC	—	53.7	73.8	—	50.2	70.2	—	46.5	66.4	—	42.6	62.4	—	38.6	58.2		
4250 CFM		EA (wb)	58	TC	106.9	106.9	121.0	101.1	101.1	114.8	95.1	95.1	108.1	88.7	88.7	101.1	82.0	82.0	93.7
				SHC	92.7	106.9	121.0	87.6	101.1	114.8	82.1	95.1	108.1	76.3	88.7	101.1	70.3	82.0	93.7
	62		TC	107.0	107.0	125.9	101.2	101.2	119.4	95.2	95.2	112.6	88.8	88.8	105.4	82.1	82.1	97.7	
			SHC	88.1	107.0	125.9	83.1	101.2	119.4	77.8	95.2	112.6	72.2	88.8	105.4	66.4	82.1	97.7	
	67		TC	112.6	112.6	115.4	105.9	105.9	111.7	98.7	98.7	107.8	91.3	91.3	103.8	83.5	83.5	99.5	
			SHC	71.8	93.6	115.4	68.2	90.0	111.7	64.4	86.1	107.8	60.5	82.2	103.8	56.6	78.0	99.5	
	72	TC	123.7	123.7	123.7	116.5	116.5	116.5	108.8	108.8	108.8	100.7	100.7	100.7	92.2	92.2	92.2		
		SHC	50.7	72.4	94.3	47.1	68.9	90.7	43.5	65.2	87.0	39.7	61.3	83.0	35.7	57.3	79.0		
	76	TC	—	133.4	133.4	—	125.6	125.6	—	117.3	117.3	—	108.6	108.6	—	99.5	99.5		
		SHC	—	55.4	77.3	—	51.8	73.5	—	48.1	69.6	—	44.1	65.5	—	40.0	61.1		

#### LEGEND

—	Do not operate
CFM	Cubic feet per minute (supply air)
EAT (db)	Entering Air Temperature (dry bulb)
EAT (wb)	Entering Air Temperature (wet bulb)
SHC	Sensible Heat Capacity (1000 Btuh) Gross
TC	Total Capacity (1000 Btuh) Gross



## COOLING CAPACITIES - FIRST STAGE, PART LOAD (10 TONS)

48LC SIZE 12			AMBIENT TEMPERATURE (°F)																
			85			95			105			115			125				
			EA (db)			EA (db)			EA (db)			EA (db)			EA (db)				
			75	80	85	75	80	85	75	80	85	75	80	85	75	80	85		
2000 CFM	EA (wb)	58	TC	53.4	53.4	60.3	51.2	51.2	57.7	48.8	48.8	55.0	46.2	46.2	52.1	43.4	43.4	48.9	
			SHC	46.7	53.4	60.3	44.8	51.2	57.7	42.6	48.8	55.0	40.3	46.2	52.1	37.8	43.4	48.9	
		62	TC	53.5	53.5	62.6	51.3	51.3	60.0	48.8	48.8	57.1	46.2	46.2	54.1	43.5	43.5	50.8	
			SHC	44.5	53.5	62.6	42.6	51.3	60.0	40.6	48.8	57.1	38.4	46.2	54.1	36.1	43.5	50.8	
		67	TC	56.6	56.6	58.1	53.6	53.6	56.9	50.6	50.6	55.6	47.4	47.4	54.2	44.0	44.0	52.7	
			SHC	36.9	47.5	58.1	35.7	46.3	56.9	34.5	45.0	55.6	33.2	43.7	54.2	31.8	42.2	52.7	
	72	TC	62.3	62.3	62.3	59.2	59.2	59.2	55.9	55.9	55.9	52.4	52.4	52.4	48.6	48.6	48.6		
		SHC	26.5	37.2	47.9	25.4	36.1	46.7	24.2	34.8	45.5	22.9	33.5	44.3	21.5	32.3	42.9		
	76	TC	—	67.3	67.3	—	64.1	64.1	—	60.5	60.5	—	56.7	56.7	—	52.7	52.7		
		SHC	—	28.8	39.5	—	27.7	38.4	—	26.5	37.2	—	25.3	36.0	—	24.0	34.7		
	2300 CFM	EA (wb)	58	TC	55.7	55.7	62.8	53.3	53.3	60.1	50.7	50.7	57.1	48.0	48.0	54.1	45.0	45.0	50.7
				SHC	48.7	55.7	62.8	46.5	53.3	60.1	44.3	50.7	57.1	41.8	48.0	54.1	39.3	45.0	50.7
62			TC	55.8	55.8	65.1	53.3	53.3	62.4	50.8	50.8	59.4	48.1	48.1	56.2	45.0	45.0	52.7	
			SHC	46.3	55.8	65.1	44.4	53.3	62.4	42.2	50.8	59.4	39.9	48.1	56.2	37.3	45.0	52.7	
67			TC	57.5	57.5	63.7	54.6	54.6	62.4	51.5	51.5	60.9	48.3	48.3	59.4	45.1	45.1	56.6	
			SHC	39.5	51.6	63.7	38.2	50.3	62.4	37.0	48.9	60.9	35.6	47.5	59.4	33.6	45.0	56.6	
72		TC	63.3	63.3	63.3	60.1	60.1	60.1	56.6	56.6	56.6	53.0	53.0	53.0	49.1	49.1	49.1		
		SHC	27.6	39.8	52.0	26.4	38.6	50.8	25.3	37.4	49.6	23.9	36.1	48.3	22.6	34.8	46.9		
76		TC	—	68.3	68.3	—	64.9	64.9	—	61.3	61.3	—	57.5	57.5	—	53.4	53.4		
		SHC	—	30.1	42.5	—	29.1	41.3	—	27.9	40.2	—	26.6	38.9	—	25.3	37.5		
2650 CFM		EA (wb)	58	TC	57.8	57.8	65.1	55.3	55.3	62.3	52.6	52.6	59.3	49.6	49.6	56.0	46.5	46.5	52.5
				SHC	50.5	57.8	65.1	48.3	55.3	62.3	45.9	52.6	59.3	43.3	49.6	56.0	40.6	46.5	52.5
	62		TC	57.9	57.9	67.7	55.4	55.4	64.7	52.7	52.7	61.5	49.7	49.7	58.1	46.6	46.6	54.5	
			SHC	48.1	57.9	67.7	46.0	55.4	64.7	43.7	52.7	61.5	41.2	49.7	58.1	38.6	46.6	54.5	
	67		TC	58.6	58.6	69.7	55.7	55.7	68.3	52.8	52.8	65.5	49.7	49.7	62.4	46.6	46.6	58.5	
			SHC	42.2	56.0	69.7	41.0	54.6	68.3	39.2	52.4	65.5	37.1	49.7	62.4	34.8	46.6	58.5	
	72	TC	64.1	64.1	64.1	60.8	60.8	60.8	57.3	57.3	57.3	53.6	53.6	53.6	49.7	49.7	51.6		
		SHC	28.8	42.7	56.6	27.6	41.5	55.5	26.3	40.3	54.3	25.1	39.0	52.9	23.7	37.6	51.6		
	76	TC	—	69.1	69.1	—	65.7	65.7	—	62.1	62.1	—	58.2	58.2	—	54.0	54.0		
		SHC	—	31.7	45.7	—	30.6	44.7	—	29.3	43.5	—	28.1	42.1	—	26.8	40.9		
	2950 CFM	EA (wb)	58	TC	59.4	59.4	66.9	56.7	56.7	63.9	53.9	53.9	60.7	50.9	50.9	57.3	47.7	47.7	53.7
				SHC	51.8	59.4	66.9	49.5	56.7	63.9	47.0	53.9	60.7	44.4	50.9	57.3	41.5	47.7	53.7
62			TC	59.4	59.4	69.4	56.7	56.7	66.3	53.9	53.9	63.1	50.9	50.9	59.6	47.7	47.7	55.8	
			SHC	49.3	59.4	69.4	47.2	56.7	66.3	44.8	53.9	63.1	42.2	50.9	59.6	39.6	47.7	55.8	
67			TC	59.6	59.6	73.7	56.9	56.9	70.6	54.0	54.0	67.7	51.0	51.0	63.9	47.7	47.7	59.9	
			SHC	44.2	59.0	73.7	42.2	56.5	70.6	40.4	54.0	67.7	38.0	51.0	63.9	35.6	47.7	59.9	
72		TC	64.6	64.6	64.6	61.3	61.3	61.3	57.8	57.8	58.1	54.0	54.0	56.8	50.1	50.1	55.4		
		SHC	29.7	45.1	60.5	28.6	44.0	59.4	27.3	42.7	58.1	26.0	41.4	56.8	24.7	40.0	55.4		
76		TC	—	69.7	69.7	—	66.3	66.3	—	62.6	62.6	—	58.6	58.6	—	54.3	54.3		
		SHC	—	33.0	48.6	—	31.9	47.4	—	30.6	46.2	—	29.3	44.9	—	28.1	43.5		
3300 CFM		EA (wb)	58	TC	60.8	60.8	68.5	58.1	58.1	65.4	55.2	55.2	62.2	52.1	52.1	58.7	48.7	48.7	54.9
				SHC	53.1	60.8	68.5	50.7	58.1	65.4	48.2	55.2	62.2	45.4	52.1	58.7	42.5	48.7	54.9
	62		TC	60.8	60.8	71.2	58.1	58.1	68.0	55.2	55.2	64.5	52.1	52.1	60.9	48.8	48.8	57.0	
			SHC	50.6	60.8	71.2	48.4	58.1	68.0	45.8	55.2	64.5	43.3	52.1	60.9	40.5	48.8	57.0	
	67		TC	60.9	60.9	76.2	58.2	58.2	72.9	55.3	55.3	69.2	52.2	52.2	65.3	48.8	48.8	61.1	
			SHC	45.5	60.9	76.2	43.5	58.2	72.9	41.2	55.3	69.2	38.9	52.2	65.3	36.4	48.8	61.1	
	72	TC	65.1	65.1	65.1	61.8	61.8	63.9	58.2	58.2	62.6	54.4	54.4	61.1	50.4	50.4	59.7		
		SHC	30.8	47.9	65.0	29.6	46.7	63.9	28.4	45.4	62.6	27.1	44.2	61.1	25.7	42.7	59.7		
	76	TC	—	70.2	70.2	—	66.8	66.8	—	63.0	63.0	—	59.0	59.0	—	54.7	54.7		
		SHC	—	34.4	51.7	—	33.3	50.5	—	32.1	49.3	—	30.8	48.0	—	29.4	46.6		

### LEGEND

- Do not operate
- CFM — Cubic feet per minute (supply air)
- EAT (db) — Entering Air Temperature (dry bulb)
- EAT (wb) — Entering Air Temperature (wet bulb)
- SHC — Sensible Heat Capacity (1000 Btuh) Gross
- TC — Total Capacity (1000 Btuh) Gross



**COOLING CAPACITIES - SECOND STAGE, PART LOAD (10 TONS)**

48LC SIZE 12			AMBIENT TEMPERATURE (°F)																
			85			95			105			115			125				
			EA (db)			EA (db)			EA (db)			EA (db)			EA (db)				
			75	80	85	75	80	85	75	80	85	75	80	85	75	80	85		
2000 CFM	EA (wb)	58	TC	65.2	65.2	74.2	61.4	61.4	70.1	57.3	57.3	65.7	52.9	52.9	60.9	48.2	48.2	55.8	
			SHC	56.2	65.2	74.2	52.7	61.4	70.1	48.9	57.3	65.7	44.9	52.9	60.9	40.7	48.2	55.8	
		62	TC	67.8	67.8	72.4	63.3	63.3	69.6	58.4	58.4	66.6	53.2	53.2	63.3	48.3	48.3	58.4	
			SHC	51.2	61.8	72.4	48.4	59.0	69.6	45.3	56.0	66.6	42.1	52.7	63.3	38.2	48.3	58.4	
		67	TC	75.9	75.9	75.9	71.1	71.1	71.1	65.9	65.9	65.9	60.3	60.3	60.3	54.2	54.2	54.2	
			SHC	41.6	52.4	63.0	38.8	49.5	60.2	35.9	46.6	57.2	32.8	43.5	54.1	29.5	40.2	50.9	
	72	TC	84.8	84.8	84.8	79.9	79.9	79.9	74.4	74.4	74.4	68.4	68.4	68.4	62.0	62.0	62.0		
		SHC	31.9	42.6	53.3	29.2	39.9	50.6	26.2	37.0	47.7	23.2	33.9	44.7	20.0	30.7	41.4		
	76	TC	—	92.5	92.5	—	87.4	87.4	—	81.7	81.7	—	75.5	75.5	—	68.7	68.7		
		SHC	—	34.6	45.3	—	31.9	42.6	—	29.1	39.8	—	26.0	36.8	—	22.9	33.6		
	2300 CFM	EA (wb)	58	TC	69.2	69.2	78.8	65.2	65.2	74.5	60.9	60.9	69.8	56.4	56.4	64.7	51.4	51.4	59.3
				SHC	59.8	69.2	78.8	56.1	65.2	74.5	52.2	60.9	69.8	48.0	56.4	64.7	43.5	51.4	59.3
62			TC	70.2	70.2	80.0	65.6	65.6	77.0	61.1	61.1	72.8	56.5	56.5	67.7	51.5	51.5	62.0	
			SHC	55.8	68.0	80.0	52.8	64.9	77.0	49.3	61.1	72.8	45.2	56.5	67.7	40.9	51.5	62.0	
67			TC	78.2	78.2	78.2	73.2	73.2	73.2	67.9	67.9	67.9	62.0	62.0	62.0	55.8	55.8	56.8	
			SHC	44.7	56.9	69.1	41.8	54.0	66.3	38.8	51.1	63.3	35.7	47.9	60.2	32.4	44.7	56.8	
72		TC	87.3	87.3	87.3	82.1	82.1	82.1	76.4	76.4	76.4	70.3	70.3	70.3	63.7	63.7	63.7		
		SHC	33.3	45.6	57.9	30.5	42.9	55.2	27.6	39.9	52.2	24.5	36.9	49.1	21.3	33.5	45.8		
76		TC	—	95.0	95.0	—	89.6	89.6	—	83.8	83.8	—	77.4	77.4	—	70.4	70.4		
		SHC	—	36.4	48.8	—	33.6	46.0	—	30.8	43.1	—	27.7	40.1	—	24.5	36.9		
2650 CFM		EA (wb)	58	TC	73.2	73.2	83.3	69.0	69.0	78.7	64.5	64.5	73.8	59.7	59.7	68.4	54.5	54.5	62.7
				SHC	63.3	73.2	83.3	59.5	69.0	78.7	55.4	64.5	73.8	50.9	59.7	68.4	46.2	54.5	62.7
	62		TC	73.3	73.3	86.7	69.2	69.2	82.0	64.6	64.6	77.0	59.8	59.8	71.5	54.5	54.5	65.6	
			SHC	60.1	73.3	86.7	56.4	69.2	82.0	52.4	64.6	77.0	48.1	59.8	71.5	43.5	54.5	65.6	
	67		TC	80.2	80.2	80.2	75.2	75.2	75.2	69.6	69.6	70.1	63.7	63.7	66.9	57.2	57.2	63.6	
			SHC	48.0	62.0	76.1	45.1	59.2	73.2	42.1	56.2	70.1	38.9	52.9	66.9	35.6	49.5	63.6	
	72	TC	89.3	89.3	89.3	84.0	84.0	84.0	78.2	78.2	78.2	71.9	71.9	71.9	65.0	65.0	65.0		
		SHC	34.9	48.9	63.1	32.1	46.1	60.3	29.1	43.2	57.3	25.9	40.1	54.1	22.6	36.8	50.9		
	76	TC	—	97.2	97.2	—	91.7	91.7	—	85.6	85.6	—	79.0	79.0	—	71.9	71.9		
		SHC	—	38.3	52.6	—	35.6	49.7	—	32.7	46.8	—	29.5	43.8	—	26.3	40.5		
	2950 CFM	EA (wb)	58	TC	76.1	76.1	86.5	71.9	71.9	81.8	67.2	67.2	76.7	62.1	62.1	71.2	56.6	56.6	65.2
				SHC	65.8	76.1	86.5	61.9	71.9	81.8	57.6	67.2	76.7	53.0	62.1	71.2	48.2	56.6	65.2
62			TC	76.2	76.2	90.1	72.0	72.0	85.2	67.3	67.3	80.0	62.2	62.2	74.3	56.7	56.7	68.2	
			SHC	62.5	76.2	90.1	58.7	72.0	85.2	54.6	67.3	80.0	50.1	62.2	74.3	45.4	56.7	68.2	
67			TC	81.6	81.6	81.8	76.4	76.4	78.9	70.9	70.9	75.9	64.7	64.7	72.5	58.3	58.3	69.0	
			SHC	50.7	66.3	81.8	47.9	63.4	78.9	44.8	60.3	75.9	41.5	57.0	72.5	38.1	53.6	69.0	
72		TC	90.8	90.8	90.8	85.3	85.3	85.3	79.4	79.4	79.4	72.9	72.9	72.9	65.9	65.9	65.9		
		SHC	36.1	51.7	67.4	33.2	48.8	64.5	30.2	45.9	61.5	27.1	42.7	58.3	23.8	39.4	55.0		
76		TC	—	98.6	98.6	—	93.0	93.0	—	86.8	86.8	—	80.1	80.1	—	72.8	72.8		
		SHC	—	39.9	55.7	—	37.1	52.8	—	34.1	49.8	—	31.0	46.8	—	27.7	43.5		
3300 CFM		EA (wb)	58	TC	79.1	79.1	89.7	74.6	74.6	84.8	69.8	69.8	79.6	64.5	64.5	73.9	58.9	58.9	67.7
				SHC	68.4	79.1	89.7	64.4	74.6	84.8	60.0	69.8	79.6	55.2	64.5	73.9	50.1	58.9	67.7
	62		TC	79.2	79.2	93.4	74.7	74.7	88.4	69.9	69.9	83.0	64.6	64.6	77.1	59.0	59.0	70.7	
			SHC	64.9	79.2	93.4	61.0	74.7	88.4	56.7	69.9	83.0	52.2	64.6	77.1	47.3	59.0	70.7	
	67		TC	83.0	83.0	88.3	77.8	77.8	85.4	72.1	72.1	82.2	65.9	65.9	78.8	59.5	59.5	75.1	
			SHC	53.8	71.1	88.3	50.9	68.2	85.4	47.8	65.0	82.2	44.5	61.6	78.8	41.0	58.0	75.1	
	72	TC	92.0	92.0	92.0	86.5	86.5	86.5	80.4	80.4	80.4	73.9	73.9	73.9	66.8	66.8	66.8		
		SHC	37.4	54.8	72.2	34.5	52.0	69.3	31.5	48.9	66.3	28.4	45.7	63.1	25.1	42.4	59.8		
	76	TC	—	99.9	99.9	—	94.2	94.2	—	87.9	87.9	—	81.1	81.1	—	73.7	73.7		
		SHC	—	41.5	59.1	—	38.7	56.3	—	35.8	53.2	—	32.7	50.1	—	29.3	46.8		

**LEGEND**

- Do not operate
- CFM — Cubic feet per minute (supply air)
- EAT (db) — Entering Air Temperature (dry bulb)
- EAT (wb) — Entering Air Temperature (wet bulb)
- SHC — Sensible Heat Capacity (1000 Btuh) Gross
- TC — Total Capacity (1000 Btuh) Gross

## COOLING CAPACITIES - THIRD STAGE, FULL LOAD (10 TONS)

48LC SIZE 12			AMBIENT TEMPERATURE (°F)																
			85			95			105			115			125				
			EA (db)			EA (db)			EA (db)			EA (db)			EA (db)				
			75	80	85	75	80	85	75	80	85	75	80	85	75	80	85		
3000 CFM	EA (wb)	58	TC	103.3	103.3	117.3	97.4	97.4	111.0	91.1	91.1	104.1	84.4	84.4	96.8	77.2	77.2	89.0	
		58	SHC	89.1	103.3	117.3	83.8	97.4	111.0	78.1	91.1	104.1	72.0	84.4	96.8	65.5	77.2	89.0	
		62	TC	108.2	108.2	112.1	101.2	101.2	107.7	93.6	93.6	103.1	85.7	85.7	98.3	77.5	77.5	92.8	
		62	SHC	80.4	96.2	112.1	76.1	91.8	107.7	71.5	87.3	103.1	66.8	82.5	98.3	61.6	77.2	92.8	
		67	TC	120.1	120.1	120.1	112.6	112.6	112.6	104.6	104.6	104.6	96.0	96.0	96.0	86.9	86.9	86.9	
		67	SHC	65.9	81.8	97.7	61.5	77.5	93.4	57.0	72.9	88.8	52.5	68.3	84.2	47.6	63.5	79.4	
	72	TC	133.3	133.3	133.3	125.5	125.5	125.5	116.9	116.9	116.9	107.8	107.8	107.8	98.2	98.2	98.2		
	72	SHC	51.1	67.1	83.1	46.8	62.8	78.8	42.4	58.4	74.4	37.8	53.7	69.7	33.1	48.9	64.9		
	76	TC	—	144.6	144.6	—	136.4	136.4	—	127.6	127.6	—	118.0	118.0	—	107.8	107.8		
	76	SHC	—	55.0	71.1	—	50.8	66.9	—	46.5	62.6	—	41.9	58.0	—	37.1	53.2		
	3500 CFM	EA (wb)	58	TC	110.0	110.0	124.9	103.7	103.7	118.1	97.1	97.1	110.9	90.0	90.0	103.1	82.5	82.5	94.8
			58	SHC	95.2	110.0	124.9	89.4	103.7	118.1	83.4	97.1	110.9	77.0	90.0	103.1	70.1	82.5	94.8
62			TC	112.2	112.2	124.4	105.1	105.1	119.7	97.5	97.5	114.8	90.2	90.2	107.5	82.6	82.6	99.0	
62			SHC	87.8	106.1	124.4	83.4	101.6	119.7	78.6	96.6	114.8	72.7	90.2	107.5	66.1	82.6	99.0	
67			TC	123.8	123.8	123.8	116.1	116.1	116.1	107.7	107.7	107.7	98.9	98.9	98.9	89.4	89.4	89.4	
67			SHC	70.7	89.1	107.5	66.3	84.7	103.2	61.8	80.2	98.7	57.0	75.5	93.9	52.1	70.5	88.9	
72		TC	137.2	137.2	137.2	129.0	129.0	129.0	120.1	120.1	120.1	110.8	110.8	110.8	100.7	100.7	100.7		
72		SHC	53.3	71.9	90.4	49.0	67.6	86.1	44.6	63.1	81.5	39.9	58.4	76.9	35.0	53.5	72.1		
76		TC	—	148.6	148.6	—	140.0	140.0	—	130.8	130.8	—	121.0	121.0	—	110.5	110.5		
76		SHC	—	57.8	76.5	—	53.5	72.2	—	49.1	67.9	—	44.6	63.2	—	39.7	58.4		
4000 CFM		EA (wb)	58	TC	115.6	115.6	131.1	109.1	109.1	124.0	102.1	102.1	116.4	94.7	94.7	108.2	86.7	86.7	99.5
			58	SHC	100.1	115.6	131.1	94.2	109.1	124.0	87.8	102.1	116.4	81.1	94.7	108.2	73.9	86.7	99.5
	62		TC	116.0	116.0	135.5	109.3	109.3	129.2	102.3	102.3	121.3	94.8	94.8	112.9	86.8	86.8	103.9	
	62		SHC	94.6	115.1	135.5	89.3	109.3	129.2	83.2	102.3	121.3	76.6	94.8	112.9	69.7	86.8	103.9	
	67		TC	126.8	126.8	126.8	118.8	118.8	118.8	110.3	110.3	110.3	101.1	101.1	103.2	91.5	91.5	98.1	
	67		SHC	75.3	96.1	117.1	70.9	91.7	112.6	66.2	87.2	108.0	61.4	82.3	103.2	56.5	77.2	98.1	
	72	TC	140.1	140.1	140.1	131.7	131.7	131.7	122.8	122.8	122.8	112.9	112.9	112.9	102.6	102.6	102.6		
	72	SHC	55.4	76.3	97.4	51.1	72.1	93.0	46.6	67.6	88.5	41.8	62.8	83.8	36.9	57.8	78.8		
	76	TC	—	151.5	151.5	—	142.7	142.7	—	133.4	133.4	—	123.3	123.3	—	112.5	112.5		
	76	SHC	—	60.4	81.5	—	56.1	77.2	—	51.6	72.7	—	46.9	68.1	—	42.1	63.2		
	4500 CFM	EA (wb)	58	TC	120.3	120.3	136.4	113.6	113.6	129.0	106.3	106.3	121.1	98.6	98.6	112.5	90.3	90.3	103.4
			58	SHC	104.3	120.3	136.4	98.1	113.6	129.0	91.6	106.3	121.1	84.5	98.6	112.5	77.0	90.3	103.4
62			TC	120.5	120.5	142.0	113.7	113.7	134.4	106.5	106.5	126.2	98.7	98.7	117.4	90.4	90.4	108.0	
62			SHC	99.1	120.5	142.0	93.0	113.7	134.4	86.7	106.5	126.2	80.0	98.7	117.4	72.7	90.4	108.0	
67			TC	129.1	129.1	129.1	120.9	120.9	121.8	112.2	112.2	117.0	103.0	103.0	112.0	93.1	93.1	106.9	
67			SHC	79.6	102.9	126.3	75.1	98.5	121.8	70.5	93.8	117.0	65.6	88.8	112.0	60.5	83.7	106.9	
72		TC	142.4	142.4	142.4	133.9	133.9	133.9	124.6	124.6	124.6	114.6	114.6	114.6	104.0	104.0	104.0		
72		SHC	57.2	80.7	104.1	52.9	76.3	99.7	48.4	71.8	95.2	43.6	67.0	90.4	38.6	62.0	85.4		
76		TC	—	154.0	154.0	—	145.0	145.0	—	135.4	135.4	—	125.1	125.1	—	114.0	114.0		
76		SHC	—	62.7	86.3	—	58.4	82.0	—	53.9	77.5	—	49.2	72.7	—	44.4	67.9		
5000 CFM		EA (wb)	58	TC	124.3	124.3	140.9	117.3	117.3	133.2	109.8	109.8	125.0	101.8	101.8	116.2	93.2	93.2	106.8
			58	SHC	107.8	124.3	140.9	101.5	117.3	133.2	94.7	109.8	125.0	87.5	101.8	116.2	79.8	93.2	106.8
	62		TC	124.5	124.5	146.5	117.5	117.5	138.6	110.0	110.0	130.2	101.9	101.9	121.1	93.3	93.3	111.4	
	62		SHC	102.4	124.5	146.5	96.2	117.5	138.6	89.7	110.0	130.2	82.7	101.9	121.1	75.3	93.3	111.4	
	67		TC	131.0	131.0	135.1	122.8	122.8	130.6	113.9	113.9	125.7	104.5	104.5	120.6	94.7	94.7	115.0	
	67		SHC	83.8	109.4	135.1	79.3	104.9	130.6	74.5	100.1	125.7	69.6	95.1	120.6	64.4	89.7	115.0	
	72	TC	144.2	144.2	144.2	135.5	135.5	135.5	126.2	126.2	126.2	115.9	115.9	115.9	105.3	105.3	105.3		
	72	SHC	59.1	84.9	110.8	54.7	80.5	106.3	50.1	75.9	101.7	45.2	71.1	96.8	40.3	66.0	91.8		
	76	TC	—	155.9	155.9	—	146.8	146.8	—	137.0	137.0	—	126.6	126.6	—	115.3	115.3		
	76	SHC	—	64.9	91.0	—	60.6	86.7	—	56.2	82.1	—	51.4	77.3	—	46.5	72.3		

### LEGEND

- Do not operate
- CFM — Cubic feet per minute (supply air)
- EAT (db) — Entering Air Temperature (dry bulb)
- EAT (wb) — Entering Air Temperature (wet bulb)
- SHC — Sensible Heat Capacity (1000 Btuh) Gross
- TC — Total Capacity (1000 Btuh) Gross

**STATIC PRESSURE ADDERS (in. wg) (FACTORY OPTIONS AND/OR ACCESSORIES)**

**Low Leak Economizers**

**48LC 07 PRESSURE DROP FOR LOW LEAK ECONOMIZER**

<b>Air flow (CFM)</b>	<b>1800</b>	<b>1950</b>	<b>2100</b>	<b>2250</b>	<b>2400</b>	<b>2550</b>	<b>2700</b>	<b>2850</b>	<b>3000</b>
<b>Pressure drop (in. wg)</b>	0.038	0.048	0.060	0.072	0.086	0.101	0.117	0.135	0.153

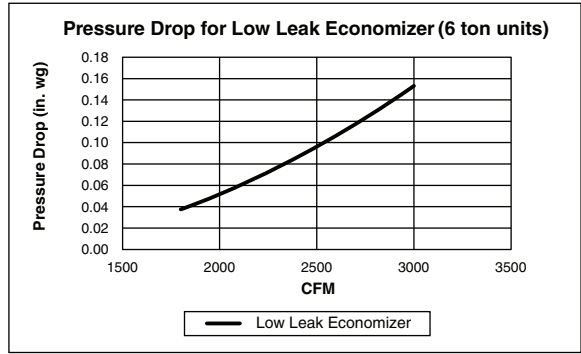

**48LC 08-12 PRESSURE DROP FOR LOW LEAK ECONOMIZER**

<b>Air flow (CFM)</b>	<b>2000</b>	<b>2500</b>	<b>3000</b>	<b>3500</b>	<b>4000</b>	<b>4500</b>	<b>5000</b>
<b>Pressure drop (in. wg)</b>	0.006	0.009	0.013	0.018	0.024	0.030	0.037

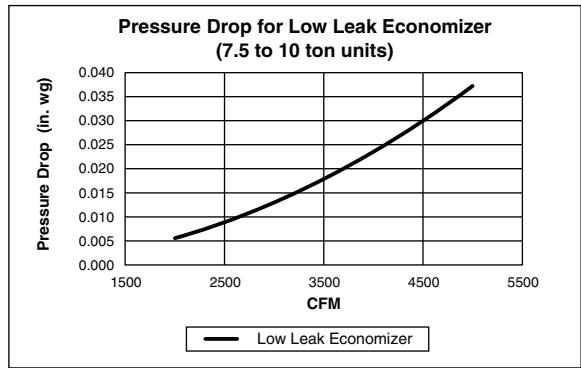

## STATIC PRESSURE ADDERS (in. wg) (FACTORY OPTIONS AND/OR ACCESSORIES) (cont)

### Humidi-MiZer® Coil

#### 48LC 07 PRESSURE DROP FOR HUMIDI-MIZER COIL

Air flow (CFM)	1800	1950	2100	2250	2400	2550	2700	2850	3000
Pressure drop (in. wg)	0.073	0.081	0.090	0.099	0.108	0.118	0.129	0.139	0.150

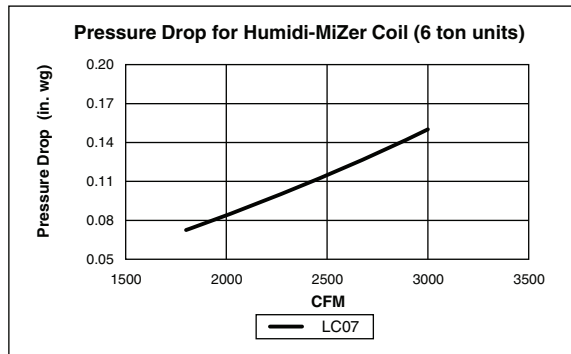

#### 48LC 08-12 PRESSURE DROP FOR HUMIDI-MIZER COIL

Air flow (CFM)	2000	2500	3000	3500	4000	4500	5000
Pressure drop (in. wg)	0.022	0.029	0.037	0.046	0.056	0.066	0.077

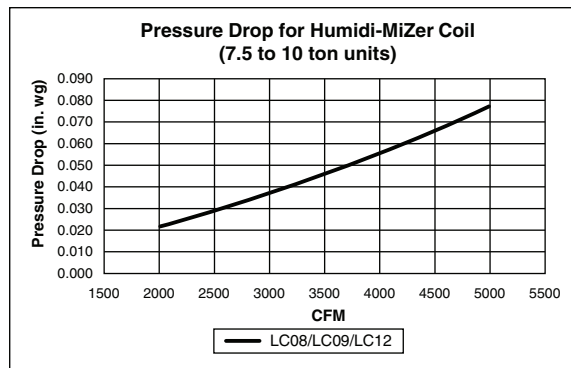

**STATIC PRESSURE ADDERS (in. wg) (FACTORY OPTIONS AND/OR ACCESSORIES) (cont)**

**Pressure Drop for Gas Heat Exchanger**

**48LC 07 PRESSURE DROP ACROSS GAS HEAT EXCHANGER (VERTICAL SUPPLY)**

CFM	1800	1950	2100	2250	2400	2550	2700	2850	3000
<b>3 Cell</b>	0.017	0.020	0.022	0.024	0.027	0.029	0.032	0.035	0.038
<b>5 Cell</b>	0.028	0.032	0.036	0.041	0.046	0.052	0.057	0.063	0.069
<b>7 Cell</b>	0.071	0.079	0.087	0.096	0.105	0.114	0.124	0.134	0.144
<b>9 Cell</b>	0.068	0.077	0.086	0.096	0.106	0.116	0.127	0.138	0.150
<b>10 Cell</b>	0.083	0.096	0.109	0.124	0.139	0.156	0.173	0.191	0.210

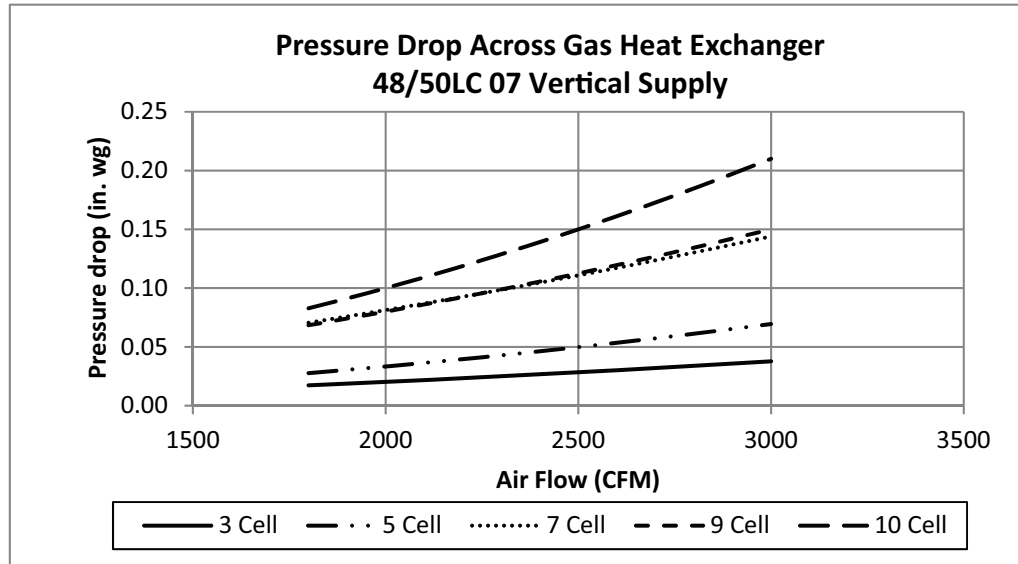

**48LC 08-12 PRESSURE DROP ACROSS GAS HEAT EXCHANGER (VERTICAL SUPPLY)**

CFM	2000	2500	3000	3500	4000	4500	5000
<b>5 Cell</b>	0.028	0.040	0.053	0.069	0.086	0.106	0.127
<b>6 Cell</b>	0.035	0.050	0.067	0.087	0.109	0.134	0.161
<b>8 Cell</b>	0.042	0.060	0.081	0.105	0.132	0.162	0.195
<b>10 cell</b>	0.064	0.091	0.123	0.158	0.198	0.242	0.291

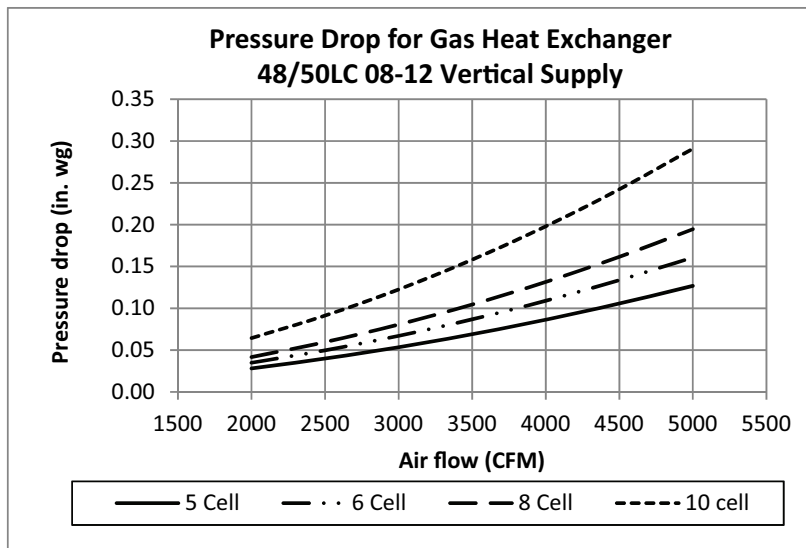

## STATIC PRESSURE ADDERS (in. wg) (FACTORY OPTIONS AND/OR ACCESSORIES) (cont)

### Pressure Adder Between Gas Heat Exchanger Sizes

#### 48LC 07 ESP ADDER, VERTICAL SUPPLY

CFM	1800	1950	2100	2250	2400	2550	2700	2850	3000
10 Cell to 9 Cell	0.014	0.019	0.023	0.028	0.034	0.040	0.046	0.053	0.060
10 Cell to 7 Cell	0.012	0.017	0.022	0.028	0.035	0.042	0.049	0.058	0.066
10 Cell to 5 Cell	0.055	0.064	0.073	0.082	0.093	0.104	0.115	0.128	0.140
10 Cell to 3 Cell	0.065	0.076	0.087	0.099	0.112	0.126	0.141	0.156	0.172

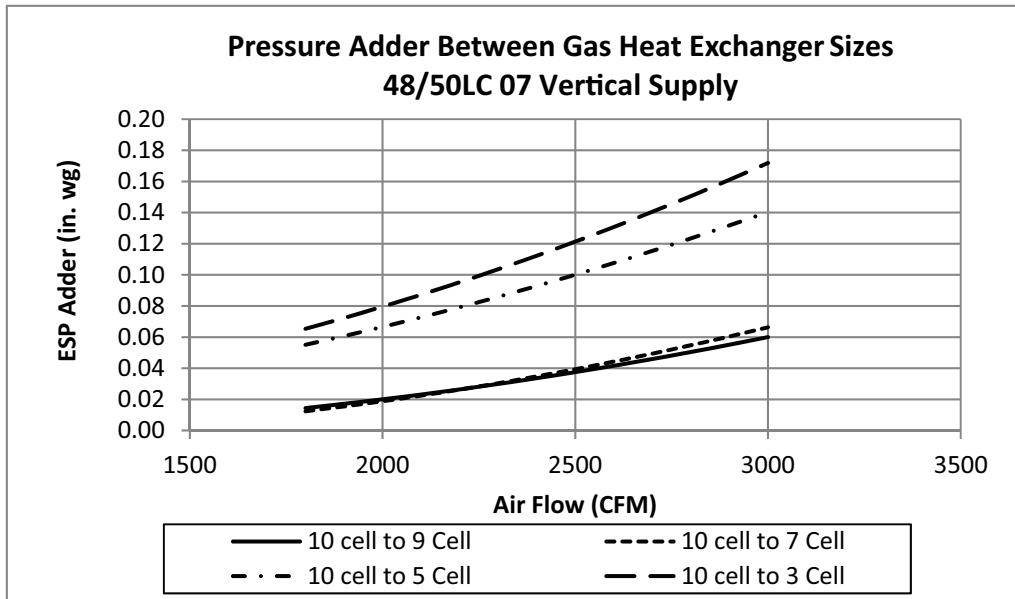

#### 48LC 08-12 ESP ADDER, VERTICAL SUPPLY

C.F.M.	2000	2500	3000	3500	4000	4500	5000
10 to 5 Cell.	0.036	0.051	0.069	0.089	0.112	0.137	0.164
10 to 6 Cell.	0.029	0.042	0.055	0.071	0.089	0.109	0.130
10 to 8 Cell.	0.023	0.032	0.042	0.054	0.066	0.081	0.096

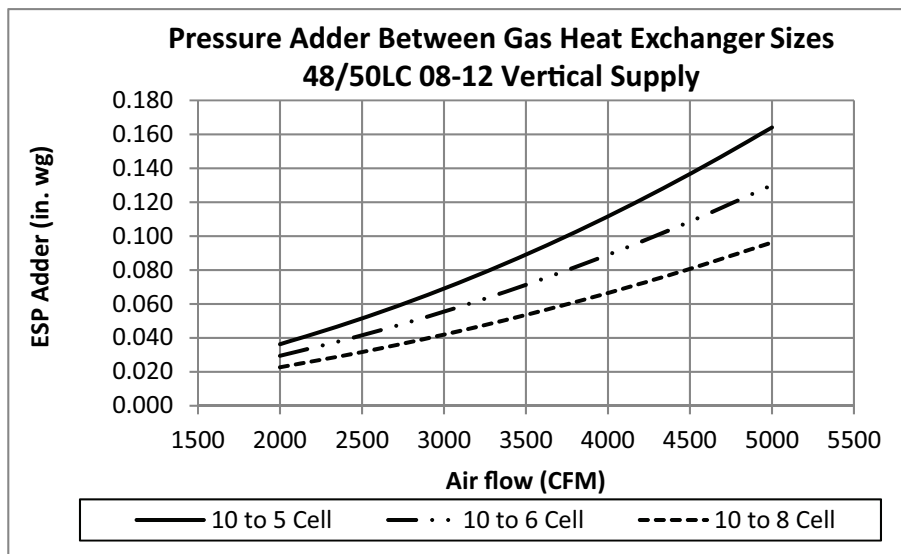

**STATIC PRESSURE ADDERS (in. wg) (FACTORY OPTIONS AND/OR ACCESSORIES) (cont)**

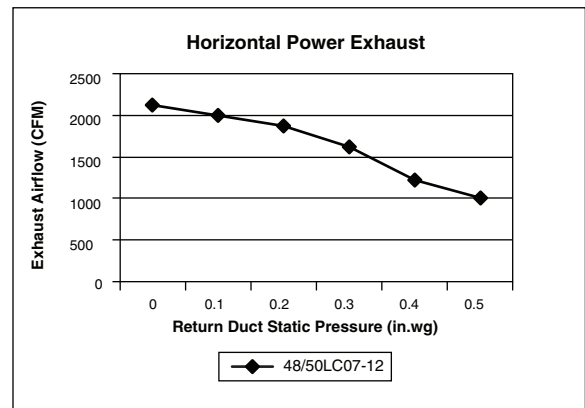
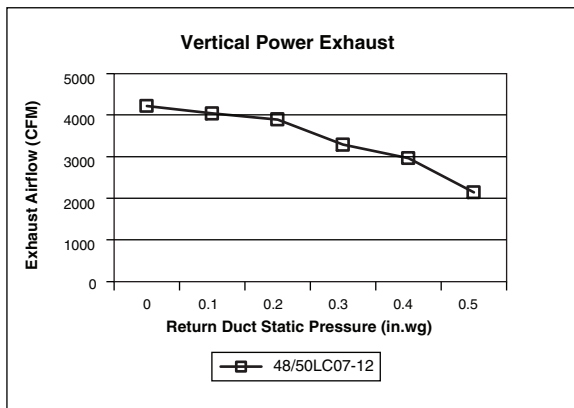
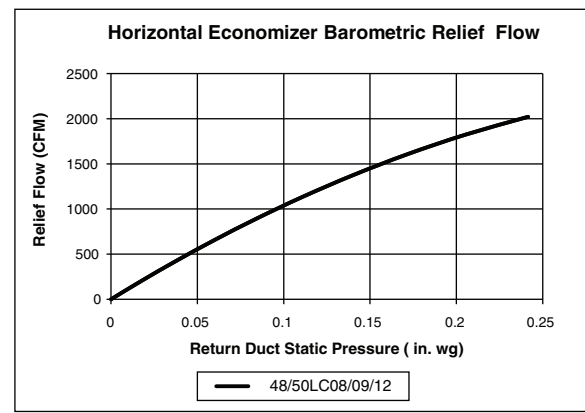
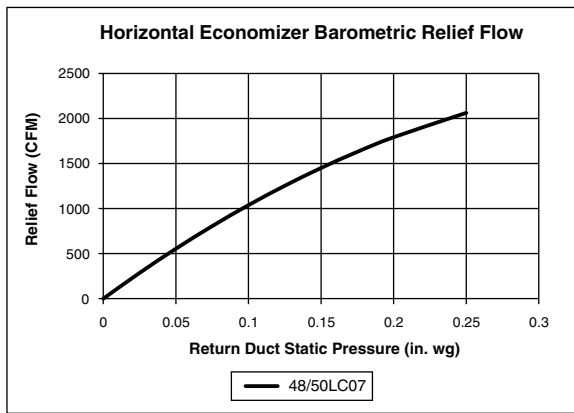
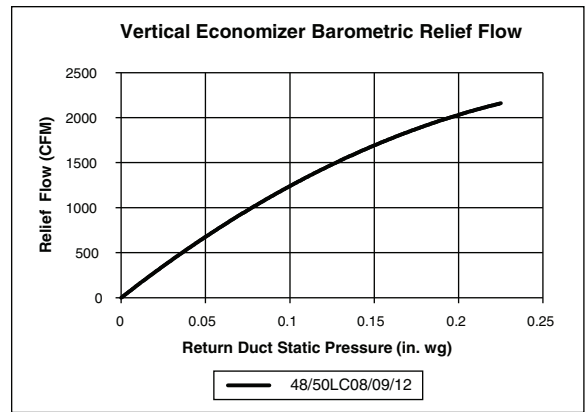
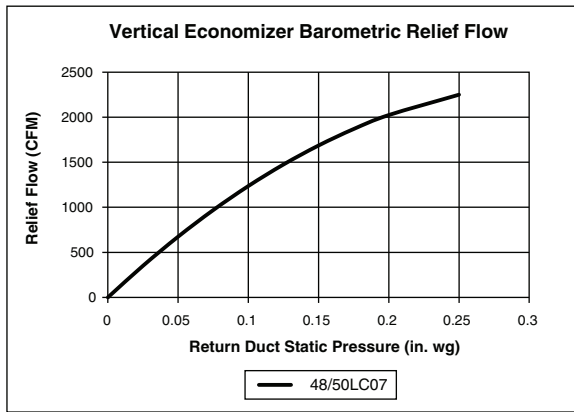

## GENERAL FAN PERFORMANCE NOTES:

1. Interpolation is permissible. Do not extrapolate.
2. External static pressure is the static pressure difference between the return duct and the supply duct plus the static pressure caused by any FIOPs or accessories.
3. Tabular data accounts for pressure loss due to clean filters, unit casing, and wet coils. Factory options and accessories may add static pressure losses. Selection software is available, through your salesperson, to help you select the best motor/drive combination for your application.
4. The fan performance tables offer motor/drive recommendations. In cases when two motor/drive combinations would work, Carrier recommends the lower horsepower option.
5. For information on the electrical properties of Carrier motors, please see the Electrical information section of this book.
6. For more information on the performance limits of Carrier motors, see the application data section of this book.
7. The EPACT (Energy Policy Act) regulates energy requirements for specific types of indoor fan motors. Motors regulated by EPACT include any general purpose, T-frame (three-digit, 143 and larger), single-speed, foot mounted, polyphase, squirrel cage induction motors of NEMA (National Electrical Manufacturers Association) design A and B, manufactured for use in the United States. Ranging from 1 to 200 Hp, these continuous-duty motors operate on 230 and 460 volt, 60 Hz power. If a motor does not fit into these specifications, the motor does not have to be replaced by an EPACT compliant energy-efficient motor. Variable-speed motors are exempt from EPACT compliance requirements.

### 48LC 07 — 6 TON HORIZONTAL SUPPLY

CFM	AVAILABLE EXTERNAL STATIC PRESSURE (in. wg)									
	0.2		0.4		0.6		0.8		1.0	
	RPM	BHP	RPM	BHP	RPM	BHP	RPM	BHP	RPM	BHP
<b>1800</b>	<b>399</b>	<b>0.22</b>	502	0.34	592	0.48	671	0.62	743	0.77
<b>1950</b>	<b>414</b>	<b>0.26</b>	512	0.39	599	0.53	677	0.68	748	0.84
<b>2100</b>	431	0.31	524	0.44	608	0.58	684	0.74	754	0.91
<b>2250</b>	448	0.36	536	0.50	617	0.65	692	0.81	760	0.98
<b>2400</b>	467	0.42	550	0.56	628	0.72	700	0.89	767	1.07
<b>2550</b>	486	0.48	564	0.63	639	0.79	710	0.97	775	1.15
<b>2700</b>	505	0.56	580	0.71	652	0.88	720	1.06	784	1.25
<b>2850</b>	525	0.64	596	0.80	665	0.97	731	1.16	793	1.35
<b>3000</b>	545	0.73	613	0.89	679	1.07	743	1.26	803	1.47

CFM	AVAILABLE EXTERNAL STATIC PRESSURE (in. wg)									
	1.2		1.4		1.6		1.8		2.0	
	RPM	BHP	RPM	BHP	RPM	BHP	RPM	BHP	RPM	BHP
<b>1800</b>	808	0.93	868	1.10	925	1.27	978	1.44	1028	1.63
<b>1950</b>	813	1.00	873	1.18	929	1.35	982	1.54	1032	1.73
<b>2100</b>	818	1.08	878	1.26	934	1.45	986	1.64	1037	1.83
<b>2250</b>	824	1.16	883	1.35	938	1.54	991	1.74	1041	1.94
<b>2400</b>	830	1.25	888	1.45	943	1.65	996	1.85	1045	2.06
<b>2550</b>	837	1.35	894	1.55	949	1.75	1001	1.97	1050	2.19
<b>2700</b>	844	1.45	901	1.66	955	1.87	1006	2.09	1055	2.31
<b>2850</b>	852	1.56	908	1.77	962	1.99	1012	2.22	1061	2.45
<b>3000</b>	861	1.68	916	1.90	969	2.13	1019	2.36	1067	2.60

**Boldface** indicates field-supplied drive is required (Standard motor, motor pulley P/N VP34 5/8, blower pulley P/N AK109 X 1, belt P/N KR29AF046) for the 322-484 rpm range.

- STD Static (421-631 rpm) 1.7 Max BHP
- MID Static (605-908 rpm) 1.7 Max BHP
- HIGH Static (847-1150 rpm) 2.9 Max BHP





### 48LC 07 — 6 TON VERTICAL SUPPLY

CFM	AVAILABLE EXTERNAL STATIC PRESSURE (in. wg)									
	0.2		0.4		0.6		0.8		1.0	
	RPM	BHP	RPM	BHP	RPM	BHP	RPM	BHP	RPM	BHP
1800	427	0.25	528	0.38	617	0.52	695	0.67	765	0.82
1950	445	0.30	542	0.43	627	0.58	704	0.73	773	0.90
2100	464	0.35	556	0.49	639	0.65	713	0.81	782	0.98
2250	484	0.41	571	0.56	651	0.72	724	0.89	791	1.07
2400	504	0.48	587	0.63	664	0.80	735	0.98	801	1.16
2550	526	0.56	604	0.71	679	0.89	748	1.07	812	1.27
2700	547	0.64	622	0.81	694	0.99	761	1.18	823	1.38
2850	569	0.73	641	0.91	710	1.09	774	1.29	836	1.50
3000	592	0.84	660	1.02	726	1.21	789	1.42	849	1.63

CFM	AVAILABLE EXTERNAL STATIC PRESSURE (in. wg)									
	1.2		1.4		1.6		1.8		2.0	
	RPM	BHP	RPM	BHP	RPM	BHP	RPM	BHP	RPM	BHP
1800	829	0.99	889	1.16	945	1.33	998	1.51	1048	1.70
1950	837	1.07	896	1.25	952	1.43	1004	1.62	1054	1.81
2100	845	1.16	904	1.34	959	1.53	1011	1.73	1060	1.93
2250	853	1.25	911	1.45	966	1.65	1018	1.85	1067	2.06
2400	862	1.36	920	1.56	974	1.76	1025	1.98	1074	2.19
2550	872	1.47	929	1.68	982	1.89	1033	2.11	1082	2.33
2700	883	1.59	938	1.80	991	2.02	1042	2.25	1090	2.48
2850	894	1.72	949	1.94	1001	2.17	1051	2.40	1098	2.64
3000	905	1.85	959	2.08	1011	2.32	1060	2.56	—	—

- STD Static (421-631 rpm) 1.7 Max BHP
- MID Static (605-908 rpm) 1.7 Max BHP
- HIGH Static (847-1150 rpm) 2.9 Max BHP

## 48LC 08 — 7.5 TON HORIZONTAL SUPPLY

CFM	AVAILABLE EXTERNAL STATIC PRESSURE (in. wg)									
	0.2		0.4		0.6		0.8		1.0	
	RPM	BHP	RPM	BHP	RPM	BHP	RPM	BHP	RPM	BHP
2250	<b>347</b>	<b>0.26</b>	457	0.49	546	0.76	621	1.07	686	1.40
2438	<b>356</b>	<b>0.29</b>	463	0.53	551	0.81	626	1.13	692	1.47
2625	<b>366</b>	<b>0.33</b>	469	0.57	556	0.86	631	1.19	697	1.54
2813	377	0.37	476	0.62	562	0.92	636	1.25	702	1.61
3000	388	0.42	483	0.67	567	0.98	641	1.32	707	1.69
3188	401	0.47	491	0.73	573	1.04	647	1.39	713	1.76
3375	414	0.54	500	0.79	580	1.11	652	1.46	718	1.85
3563	427	0.60	509	0.87	587	1.18	658	1.55	723	1.94
3750	441	0.68	519	0.94	595	1.27	664	1.63	729	2.03

CFM	AVAILABLE EXTERNAL STATIC PRESSURE (in. wg)									
	1.2		1.4		1.6		1.8		2.0	
	RPM	BHP	RPM	BHP	RPM	BHP	RPM	BHP	RPM	BHP
2250	744	1.75	798	2.11	847	2.49	893	2.89	936	3.31
2438	750	1.82	804	2.20	854	2.60	900	3.01	944	3.43
2625	756	1.91	810	2.30	860	2.70	907	3.12	951	3.56
2813	762	1.99	816	2.39	866	2.81	913	3.24	958	3.69
3000	767	2.08	822	2.49	872	2.92	919	3.36	964	3.82
3188	772	2.17	827	2.59	878	3.03	925	3.48	970	3.95
3375	777	2.26	832	2.69	883	3.14	931	3.61	976	4.09
3563	782	2.36	837	2.80	888	3.26	936	3.74	981	4.23
3750	788	2.46	842	2.91	894	3.38	941	3.87	987	4.37

**Boldface** indicates field-supplied drive is required (Standard motor, motor pulley P/N KR11HY151, blower pulley P/N AK114 1 3/16, belt P/N A47) for the 322-484 rpm range.

- STD Static (375-563 rpm) 1.7 Max BHP
- MID Static (547-757 rpm) 2.4 Max BHP
- HIGH Static (710-879 rpm) 3.7 Max BHP
- ULTRA HIGH Static (832-1021 rpm) 4.9 Max BHP  
\*At 575v, Max BHP is 4.7

### 48LC 08 — 7.5 TON VERTICAL SUPPLY

CFM	AVAILABLE EXTERNAL STATIC PRESSURE (in. wg)									
	0.2		0.4		0.6		0.8		1.0	
	RPM	BHP	RPM	BHP	RPM	BHP	RPM	BHP	RPM	BHP
<b>2250</b>	<b>360</b>	<b>0.28</b>	470	0.52	555	0.80	625	1.09	686	1.40
<b>2438</b>	<b>370</b>	<b>0.32</b>	478	0.57	563	0.86	633	1.16	695	1.48
<b>2625</b>	380	0.35	485	0.62	570	0.92	642	1.24	704	1.57
<b>2813</b>	390	0.40	493	0.67	578	0.98	649	1.32	712	1.67
<b>3000</b>	402	0.45	501	0.73	586	1.05	657	1.40	720	1.76
<b>3188</b>	414	0.51	510	0.79	593	1.13	665	1.49	728	1.86
<b>3375</b>	427	0.57	519	0.86	601	1.21	673	1.58	736	1.97
<b>3563</b>	440	0.64	529	0.94	609	1.29	680	1.67	743	2.07
<b>3750</b>	454	0.72	539	1.02	618	1.38	688	1.77	751	2.19

CFM	AVAILABLE EXTERNAL STATIC PRESSURE (in. wg)									
	1.2		1.4		1.6		1.8		2.0	
	RPM	BHP	RPM	BHP	RPM	BHP	RPM	BHP	RPM	BHP
<b>2250</b>	740	1.72	789	2.05	835	2.40	<b>878</b>	<b>2.76</b>	918	3.13
<b>2438</b>	750	1.82	800	2.17	846	2.53	889	2.90	929	3.29
<b>2625</b>	759	1.92	809	2.29	856	2.66	899	3.05	940	3.45
<b>2813</b>	768	2.03	819	2.41	866	2.80	909	3.20	950	3.61
<b>3000</b>	776	2.14	828	2.54	875	2.94	919	3.36	960	3.78
<b>3188</b>	785	2.26	836	2.66	884	3.08	928	3.51	970	3.95
<b>3375</b>	793	2.37	845	2.80	892	3.23	937	3.67	979	4.13
<b>3563</b>	800	2.50	853	2.93	901	3.38	946	3.84	988	4.31
<b>3750</b>	808	2.62	861	3.07	909	3.53	954	4.01	997	4.49

**Boldface** indicates field-supplied drive is required (Standard motor, motor pulley P/N KR11HY151, blower pulley P/N AK114 1 3/16, belt P/N A47) for the 322-484 rpm range.

- STD Static (375-563 rpm) 1.7 Max BHP
- MID Static (547-757 rpm) 2.4 Max BHP
- HIGH Static (710-879 rpm) 3.7 Max BHP
- ULTRA HIGH Static (832-1021 rpm) 4.9 Max BHP  
\*At 575v, Max BHP is 4.7

## 48LC 09 — 8.5 TON HORIZONTAL SUPPLY

CFM	AVAILABLE EXTERNAL STATIC PRESSURE (in. wg)									
	0.2		0.4		0.6		0.8		1.0	
	RPM	BHP	RPM	BHP	RPM	BHP	RPM	BHP	RPM	BHP
2550	362	0.31	466	0.55	554	0.84	629	1.16	695	1.51
2763	374	0.36	474	0.61	560	0.90	635	1.23	701	1.59
2975	387	0.41	482	0.66	567	0.97	641	1.31	707	1.67
3188	401	0.47	491	0.73	573	1.04	647	1.39	713	1.76
3400	415	0.54	501	0.80	581	1.12	653	1.47	718	1.86
3613	431	0.62	512	0.89	589	1.21	660	1.57	725	1.96
3825	447	0.71	524	0.98	598	1.30	667	1.67	731	2.07
4038	463	0.81	536	1.08	607	1.41	675	1.78	738	2.19
4250	480	0.91	549	1.19	618	1.52	683	1.90	745	2.32

CFM	AVAILABLE EXTERNAL STATIC PRESSURE (in. wg)									
	1.2		1.4		1.6		1.8		2.0	
	RPM	BHP	RPM	BHP	RPM	BHP	RPM	BHP	RPM	BHP
2550	754	1.87	808	2.26	858	2.66	904	3.08	948	3.51
2763	760	1.97	815	2.36	865	2.78	912	3.21	956	3.66
2975	766	2.06	821	2.47	871	2.90	919	3.34	963	3.80
3188	772	2.17	827	2.59	878	3.03	925	3.48	970	3.95
3400	778	2.27	833	2.70	884	3.16	932	3.62	977	4.11
3613	784	2.38	839	2.83	890	3.29	938	3.77	983	4.27
3825	790	2.50	845	2.96	896	3.43	944	3.92	989	4.43
4038	796	2.63	850	3.09	901	3.58	949	4.08	995	4.60
4250	802	2.76	857	3.24	907	3.73	955	4.24	1001	4.77

**Boldface** indicates field-supplied drive is required (Standard motor, motor pulley P/N KR11HY151, blower pulley P/N AK114 1 3/16, belt P/N A47) for the 308-462 rpm range.

- STD Static (375-563 rpm) 1.7 Max BHP
- MID Static (547-757 rpm) 2.4 Max BHP
- HIGH Static (710-879 rpm) 3.7 Max BHP
- ULTRA HIGH Static (832-1021 rpm) 4.9 Max BHP  
\*At 575v, Max BHP is 4.7



### 48LC 09 — 8.5 TON VERTICAL SUPPLY

CFM	AVAILABLE EXTERNAL STATIC PRESSURE (in. wg)									
	0.2		0.4		0.6		0.8		1.0	
	RPM	BHP	RPM	BHP	RPM	BHP	RPM	BHP	RPM	BHP
2550	376	0.34	482	0.60	567	0.89	638	1.21	700	1.54
2763	387	0.39	491	0.66	576	0.97	647	1.30	710	1.64
2975	400	0.44	500	0.72	585	1.04	656	1.39	719	1.75
3188	414	0.51	510	0.79	593	1.13	665	1.49	728	1.86
3400	428	0.58	520	0.87	602	1.22	674	1.59	737	1.98
3613	444	0.66	531	0.96	611	1.31	682	1.70	745	2.11
3825	459	0.75	543	1.06	621	1.42	691	1.81	754	2.23
4038	476	0.85	556	1.16	631	1.53	700	1.94	763	2.37
4250	493	0.96	569	1.28	642	1.65	709	2.07	771	2.52

CFM	AVAILABLE EXTERNAL STATIC PRESSURE (in. wg)									
	1.2		1.4		1.6		1.8		2.0	
	RPM	BHP	RPM	BHP	RPM	BHP	RPM	BHP	RPM	BHP
2550	755	1.88	806	2.24	852	2.61	895	2.99	936	3.38
2763	765	2.00	816	2.38	863	2.76	907	3.16	948	3.57
2975	775	2.13	826	2.52	874	2.92	918	3.34	959	3.76
3188	785	2.26	836	2.66	884	3.08	928	3.51	970	3.95
3400	794	2.39	846	2.81	894	3.25	938	3.70	980	4.15
3613	803	2.53	855	2.97	903	3.42	948	3.88	990	4.36
3825	811	2.67	864	3.13	912	3.59	958	4.07	1000	4.56
4038	820	2.82	872	3.29	921	3.78	967	4.27	1010	4.78
4250	828	2.98	881	3.47	930	3.96	976	4.47	1019	5.00

*Italics* indicate field-supplied drive is required (Motor P/N HD60FK657, motor pulley P/N KR11HY229, blower pulley P/N KR51BH615, belt P/N BX41) for the 890-1092 rpm range.

- STD Static (375-563 rpm) 1.7 Max BHP
- MID Static (547-757 rpm) 2.4 Max BHP
- HIGH Static (710-879 rpm) 3.7 Max BHP
- ULTRA HIGH Static (832-1021 rpm) 4.9 Max BHP  
\*At 575v, Max BHP is 4.7

## 48LC 12 — 10 TON HORIZONTAL SUPPLY

CFM	AVAILABLE EXTERNAL STATIC PRESSURE (in. wg)									
	0.2		0.4		0.6		0.8		1.0	
	RPM	BHP	RPM	BHP	RPM	BHP	RPM	BHP	RPM	BHP
3000	<b>388</b>	<b>0.42</b>	483	0.67	567	0.98	641	1.32	707	1.69
3250	<b>405</b>	<b>0.49</b>	494	0.75	576	1.06	649	1.41	714	1.79
3500	423	0.58	506	0.84	585	1.16	656	1.52	721	1.91
3750	441	0.68	519	0.94	595	1.27	664	1.63	729	2.03
4000	460	0.79	534	1.06	606	1.39	673	1.76	736	2.17
4250	480	0.91	549	1.19	618	1.52	683	1.90	745	2.32
4500	501	1.05	566	1.34	631	1.67	694	2.06	754	2.48
4750	522	1.21	583	1.50	645	1.84	706	2.23	764	2.66
5000	543	1.38	601	1.68	660	2.02	718	2.42	775	2.85

CFM	AVAILABLE EXTERNAL STATIC PRESSURE (in. wg)									
	1.2		1.4		1.6		1.8		2.0	
	RPM	BHP	RPM	BHP	RPM	BHP	RPM	BHP	RPM	BHP
3000	767	2.08	822	2.49	872	2.92	919	3.36	964	3.82
3250	774	2.20	829	2.62	880	3.06	927	3.52	972	4.00
3500	781	2.32	836	2.76	887	3.22	934	3.69	979	4.18
3750	788	2.46	842	2.91	894	3.38	941	3.87	987	4.37
4000	795	2.61	849	3.07	900	3.55	948	4.05	994	4.57
4250	802	2.76	857	3.24	907	3.73	955	4.24	1001	4.77
4500	811	2.93	864	3.41	914	3.92	962	4.44	<i>1007</i>	<i>4.98</i>
4750	819	3.12	872	3.61	922	4.12	969	4.65	<i>1014</i>	<i>5.21</i>
5000	829	3.32	880	3.81	930	4.34	977	4.88	<i>1021</i>	<i>5.45</i>

**Boldface** indicates field-supplied drive is required (Standard motor, motor pulley P/N KR11HY151, blower pulley P/N KR51BL315, belt P/N KR28BF047) for the 369-487 rpm range.

*Italics* indicate field-supplied motor and drive are required (motor P/N HD60FK657, motor pulley P/N KR11HY229, blower pulley P/N KR51BH615, belt P/N BX41) in the 890-1092 rpm range.

- STD Static (421-631 rpm) 2.4 Max BHP
- MID Static (631-841 rpm) 3.7 Max BHP
- HIGH Static (832-1021 rpm) 4.9 Max BHP  
\*At 575v, HP is 4.7

### 48LC 12 — 10 TON VERTICAL SUPPLY

CFM	AVAILABLE EXTERNAL STATIC PRESSURE (in. wg)									
	0.2		0.4		0.6		0.8		1.0	
	RPM	BHP	RPM	BHP	RPM	BHP	RPM	BHP	RPM	BHP
3000	402	0.45	501	0.73	586	1.05	657	1.40	720	1.76
3250	418	0.53	513	0.82	596	1.15	667	1.51	731	1.90
3500	435	0.62	525	0.91	606	1.26	678	1.64	741	2.04
3750	454	0.72	539	1.02	618	1.38	688	1.77	751	2.19
4000	473	0.83	553	1.14	629	1.51	698	1.92	761	2.35
4250	493	0.96	569	1.28	642	1.65	709	2.07	771	2.52
4500	513	1.10	585	1.43	655	1.81	721	2.24	782	2.70
4750	534	1.26	602	1.60	669	1.99	733	2.42	793	2.89
5000	555	1.44	619	1.78	684	2.18	746	2.62	805	3.10

CFM	AVAILABLE EXTERNAL STATIC PRESSURE (in. wg)									
	1.2		1.4		1.6		1.8		2.0	
	RPM	BHP	RPM	BHP	RPM	BHP	RPM	BHP	RPM	BHP
3000	776	2.14	828	2.54	875	2.94	919	3.36	960	3.78
3250	787	2.30	839	2.71	887	3.13	931	3.57	973	4.01
3500	798	2.45	850	2.89	898	3.33	943	3.78	985	4.25
3750	808	2.62	861	3.07	909	3.53	954	4.01	997	4.49
4000	818	2.80	871	3.26	920	3.74	965	4.23	1008	4.74
4250	828	2.98	881	3.47	930	3.96	976	4.47	1019	5.00
4500	839	3.18	891	3.68	940	4.19	986	4.72	1029	5.26
4750	849	3.39	901	3.90	950	4.43	996	4.98	1040	5.54
5000	860	3.61	912	4.14	960	4.69	1006	5.25	1050	5.82

**Boldface** indicates field-supplied drive is required (Standard motor, motor pulley P/N KR11HY151, blower pulley P/N KR51BL315, belt P/N KR28BF047) for the 369-487 rpm range.  
*Italics* indicate field-supplied motor and drive are required (motor P/N HD60FK657, motor pulley P/N KR11HY229, blower pulley P/N KR51BH615, belt P/N BX41) in the 890-1092 rpm range.

- STD Static (421-631 rpm) 2.4 Max BHP
- MID Static (631-841 rpm) 3.7 Max BHP
- HIGH Static (832-1021 rpm) 4.9 Max BHP  
\*At 575v, HP is 4.7

### PULLEY ADJUSTMENT

48LC*B UNIT		MOTOR/DRIVE COMBO	MOTOR PULLEY TURNS OPEN												
			0	0.5	1	1.5	2	2.5	3	3.5	4	4.5	5	5.5	6
07	3 phase	Standard Static	631	610	589	568	547	526	505	484	463	442	421	N/A	N/A
		Medium Static	908	878	847	817	787	757	726	696	666	635	605	N/A	N/A
		High Static	N/A	N/A	1150	1120	1089	1059	1029	999	968	938	908	877	847
08	3 phase	Standard Static	563	544	525	507	488	469	450	431	413	394	375	N/A	N/A
		Medium Static	757	736	715	694	673	652	631	610	589	568	547	N/A	N/A
		High Static	879	862	845	828	811	795	778	761	744	727	710	N/A	N/A
		Ultra High Static	1021	1002	983	964	945	927	908	889	870	851	832	N/A	N/A
09	3 phase	Standard Static	563	544	525	507	488	469	450	431	413	394	375	N/A	N/A
		Medium Static	757	736	715	694	673	652	631	610	589	568	547	N/A	N/A
		High Static	879	862	845	828	811	795	778	761	744	727	710	N/A	N/A
		Ultra High Static	1021	1002	983	964	945	927	908	889	870	851	832	N/A	N/A
12	3 phase	Standard Static	631	610	589	568	547	526	505	484	463	442	421	N/A	N/A
		Medium Static	841	820	799	778	757	736	715	694	673	652	631	N/A	N/A
		High Static	1021	1002	983	964	945	927	908	889	870	851	832	N/A	N/A

Factory setting

## 48LC 07-12 ELECTRICAL INFORMATION

48LC UNIT	V-Ph-Hz	VOLTAGE RANGE		COMP 1		COMP 2		OFM (ea)		IFM		
		MIN	MAX	RLA	LRA	RLA	LRA	WATTS	FLA	TYPE	EFF at full load	FLA
07	208-3-60	187	253	8.3	58	13.2	88	195	1.8	STD	81.5%	5.8
								195	1.8	MED	81.5%	5.8
								195	1.8	HIGH	84.5%	8.6
	230-3-60	187	253	8.3	58	13.2	88	195	1.8	STD	81.5%	5.6
								195	1.8	MED	81.5%	5.6
								195	1.8	HIGH	84.5%	7.8
	460-3-60	414	506	5.1	28	6.0	44	195	1.8	STD	81.5%	2.9
								195	1.8	MED	81.5%	2.9
								195	1.8	HIGH	84.5%	3.8
	575-3-60	518	633	3.3	24	4.2	30	195	1.8	STD	81.5%	2.8
								195	1.8	MED	81.5%	2.8
								195	1.8	HIGH	84.5%	4.5
08	208-3-60	187	253	13.2	88	13.7	83	195	1.8	STD	81.5%	5.8
								195	1.8	MED	80.0%	7.1
								195	1.8	HIGH	84.5%	10.8
	230-3-60	187	253	13.2	88	13.7	83	195	1.8	ULTRA	82.0%	13.6
								195	1.8	STD	81.5%	5.6
								195	1.8	MED	80.0%	6.8
	460-3-60	414	506	6.0	44	6.2	41	195	1.8	HIGH	84.5%	9.8
								195	1.8	ULTRA	82.0%	12.7
								195	1.8	STD	81.5%	2.9
	575-3-60	518	633	4.2	30	4.8	33	195	1.8	MED	80.0%	3.4
								195	1.8	HIGH	84.5%	4.9
								195	1.8	ULTRA	82.0%	6.4
09	208-3-60	187	253	13.2	88	15.9	110	195	1.8	STD	81.5%	2.8
								195	1.8	MED	80.0%	3.5
								195	1.8	HIGH	84.5%	4.5
	230-3-60	187	253	13.2	88	15.9	110	195	1.8	ULTRA	82.0%	6.2
								195	1.8	STD	81.5%	2.9
								195	1.8	MED	80.0%	6.8
	460-3-60	414	506	6.0	44	7.7	52	195	1.8	HIGH	84.5%	9.8
								195	1.8	ULTRA	82.0%	12.7
								195	1.8	STD	81.5%	2.9
	575-3-60	518	633	4.2	30	5.7	39	195	1.8	MED	80.0%	3.4
								195	1.8	HIGH	84.5%	4.9
								195	1.8	ULTRA	82.0%	6.4
12	208-3-60	187	253	13.1	83	19.6	136	195	1.8	STD	81.5%	2.8
								195	1.8	MED	80.0%	3.5
								195	1.8	HIGH	84.5%	4.5
	230-3-60	187	253	13.1	83	19.6	136	195	1.8	ULTRA	82.0%	6.2
								195	1.8	STD	80.0%	7.1
								195	1.8	MED	84.5%	10.8
	460-3-60	414	506	6.1	41	8.2	66	195	1.8	HIGH	82.0%	13.6
								195	1.8	STD	80.0%	6.8
								195	1.8	MED	84.5%	9.8
	575-3-60	518	633	4.4	33	6.6	55	195	1.8	ULTRA	82.0%	12.7
								195	1.8	STD	80.0%	3.4
								195	1.8	MED	84.5%	4.9
								195	1.8	HIGH	82.0%	6.4
								195	1.8	STD	80.0%	3.5
								195	1.8	MED	84.5%	4.5
								195	1.8	HIGH	82.0%	6.2
								195	1.8	STD	80.0%	3.5
								195	1.8	MED	84.5%	4.5





**UNIT WIRE/FUSE OR HACR BREAKER SIZING DATA (NO C.O. OR UNPWRD C.O.) 6 TO 10 TONS**

48LC UNIT	NOM. V-PH-HZ	IFM TYPE	NO C.O. OR UNPWR C.O.							
			NO P.E.				W/ P.E. (PWRD FR/ UNIT)			
			MCA	FUSE OR HACR BRKR	DISC. SIZE		MCA	FUSE OR HACR BRKR	DISC SIZE	
					FLA	LRA			FLA	LRA
07	208/230-3-60	STD	35/34	45/45	36/35	173	38/38	50/50	40/40	177
		MED	35/34	45/45	36/35	173	38/38	50/50	40/40	177
		HIGH	37/37	50/45	39/38	203	41/40	50/50	43/42	207
	460-3-60	STD	20	25	20	87	21	25	22	89
		MED	20	25	20	87	21	25	22	89
		HIGH	20	25	21	103	22	25	23	105
	575-3-60	STD	15	20	16	67	19	20	20	71
		MED	15	20	16	67	19	20	20	71
		HIGH	17	20	18	80	21	25	22	84
08	208/230-3-60	STD	42/42	50/50	44/44	200	46/46	50/50	48/48	204
		MED	43/43	50/50	45/45	204	47/47	60/60	50/49	208
		HIGH	47/46	60/50	50/48	254	51/50	60/60	54/53	258
		ULTRA	50/49	60/60	53/52	265	54/53	60/60	57/56	269
	460-3-60	STD	23	25	24	102	24	30	26	104
		MED	23	25	24	104	25	30	26	106
		HIGH	25	30	26	130	26	30	28	132
		ULTRA	26	30	28	135	28	30	30	137
	575-3-60	STD	19	20	20	78	23	25	24	82
		MED	20	25	21	82	23	25	25	86
		HIGH	21	25	22	91	24	30	26	95
		ULTRA	23	25	24	105	26	30	28	109
09	208/230-3-60	STD	45/45	60/50	46/46	227	49/48	60/60	51/50	231
		MED	46/46	60/60	48/47	231	50/50	60/60	52/52	235
		HIGH	50/49	60/60	52/51	281	54/53	60/60	56/55	285
		ULTRA	53/52	60/60	55/54	292	56/55	60/60	60/59	296
	460-3-60	STD	24	30	25	113	26	30	27	115
		MED	25	30	26	115	27	30	28	117
		HIGH	26	30	28	141	28	30	30	143
		ULTRA	28	30	29	146	30	35	31	148
	575-3-60	STD	20	25	21	84	24	25	25	88
		MED	21	25	22	88	24	30	26	92
		HIGH	22	25	23	97	25	30	27	101
		ULTRA	24	25	25	111	27	30	29	115
12	208/230-3-60	STD	51/50	60/60	52/52	252	54/54	60/60	56/56	256
		MED	54/53	60/60	56/55	302	58/57	70/70	61/59	306
		HIGH	57/56	70/70	59/58	313	61/60	80/70	64/63	317
	460-3-60	STD	26	30	27	126	27	30	29	128
		MED	27	30	28	152	29	35	30	154
		HIGH	29	35	30	157	30	35	32	159
	575-3-60	STD	22	25	23	107	26	30	27	111
		MED	23	25	24	116	27	30	28	120
		HIGH	25	30	26	130	29	30	30	134

See Legend and Notes on page 53.

## UNIT WIRE/FUSE OR HACR BREAKER SIZING DATA (WITH PWRD C.O.) 6 TO 10 TONS

48LC UNIT	NOM. V-PH-HZ	IFM TYPE	W/ PWRD C.O.							
			NO P.E.				W/ P.E. (PWRD FR/ UNIT)			
			MCA	FUSE OR HACR BRKR	DISC. SIZE		MCA	FUSE OR HACR BRKR	DISC SIZE	
					FLA	LRA			FLA	LRA
07	208/230-3-60	STD	39/39	50/50	41/41	178	43/43	50/50	45/45	182
		MED	39/39	50/50	41/41	178	43/43	50/50	45/45	182
		HIGH	42/41	50/50	44/43	208	46/45	50/50	49/48	212
	460-3-60	STD	22	25	23	89	24	25	25	91
		MED	22	25	23	89	24	25	25	91
		HIGH	23	25	24	105	24	30	26	107
	575-3-60	STD	17	20	18	69	21	25	22	73
		MED	17	20	18	69	21	25	22	73
		HIGH	19	20	20	82	23	25	24	86
08	208/230-3-60	STD	47/47	60/50	49/49	205	51/50	60/60	54/53	209
		MED	48/48	60/60	51/50	209	52/52	60/60	55/55	213
		HIGH	52/51	60/60	55/54	259	56/55	60/60	59/58	263
		ULTRA	55/54	60/60	58/57	270	58/57	70/70	63/62	274
	460-3-60	STD	25	30	26	104	27	30	28	106
		MED	25	30	27	106	27	30	29	108
		HIGH	27	30	28	132	29	30	30	134
		ULTRA	28	30	30	137	30	35	32	139
	575-3-60	STD	21	25	22	80	24	30	26	84
		MED	21	25	23	84	25	30	27	88
		HIGH	22	25	24	93	26	30	28	97
		ULTRA	24	30	26	107	28	30	30	111
09	208/230-3-60	STD	50/49	60/60	52/52	232	53/53	60/60	56/56	236
		MED	51/51	60/60	53/53	236	55/54	60/60	58/57	240
		HIGH	55/54	60/60	58/56	286	58/57	70/70	62/61	290
		ULTRA	57/56	70/60	61/60	297	61/60	70/70	65/64	301
	460-3-60	STD	27	30	28	115	28	30	30	117
		MED	27	30	28	117	29	35	30	119
		HIGH	29	35	30	143	30	35	32	145
		ULTRA	30	35	32	148	32	35	34	150
	575-3-60	STD	22	25	23	86	25	30	27	90
		MED	22	25	24	90	26	30	28	94
		HIGH	23	25	25	99	27	30	29	103
		ULTRA	25	30	27	113	29	35	31	117
12	208/230-3-60	STD	55/55	60/60	58/57	257	59/59	70/70	62/62	261
		MED	59/58	70/70	62/61	307	63/62	80/80	66/65	311
		HIGH	62/61	80/80	65/64	318	66/65	80/80	69/68	322
	460-3-60	STD	28	30	29	128	30	35	31	130
		MED	29	35	31	154	31	35	33	156
		HIGH	31	35	33	159	33	40	35	161
	575-3-60	STD	24	25	25	109	28	30	29	113
		MED	25	30	26	118	29	30	30	122
		HIGH	26	30	28	132	30	35	32	136

See Legend and Notes on page 53.



**UNIT WIRE SIZING DATA WITH FACTORY-INSTALLED HACR BREAKER (NO C.O. OR UNPWRD C.O.) 6 TO 10 TONS**

48LC UNIT	NOM. V-PH-HZ	IFM TYPE	NO C.O. OR UNPWR C.O.							
			NO P.E.				W/ P.E. (PWRD FR/ UNIT)			
			MCA	HACR BRKR	DISC. SIZE		MCA	HACR BRKR	DISC SIZE	
					FLA	LRA			FLA	LRA
07	208/230-3-60	STD	35/35	45/45	36/35	173	38/38	50/50	40/40	177
		MED	35/35	45/45	36/35	173	38/38	50/50	40/40	177
		HIGH	37/37	50/50	39/38	203	41/41	50/50	43/42	207
	460-3-60	STD	20	25	20	87	21	25	22	89
		MED	20	25	20	87	21	25	22	89
		HIGH	20	25	21	103	22	25	23	105
	575-3-60	STD	15	20	16	67	19	20	20	71
		MED	15	20	16	67	19	20	20	71
		HIGH	17	20	18	80	21	25	22	84
08	208/230-3-60	STD	42/42	50/50	44/44	200	46/46	50/50	48/48	204
		MED	43/43	50/50	45/45	204	47/47	60/60	50/49	208
		HIGH	47/47	60/60	50/48	254	51/51	60/60	54/53	258
		ULTRA	50/50	60/60	53/52	265	54/54	60/60	57/56	269
	460-3-60	STD	23	25	24	102	24	30	26	104
		MED	23	25	24	104	25	30	26	106
		HIGH	25	30	26	130	26	30	28	132
		ULTRA	26	30	28	135	28	30	30	137
	575-3-60	STD	19	20	20	78	23	25	24	82
		MED	20	25	21	82	23	25	25	86
		HIGH	21	25	22	91	24	30	26	95
		ULTRA	23	25	24	105	26	30	28	109
09	208/230-3-60	STD	45/45	60/60	46/46	227	49/49	60/60	51/50	231
		MED	46/46	60/60	48/47	231	50/50	60/60	52/52	235
		HIGH	50/50	60/60	52/51	281	54/54	60/60	56/55	285
		ULTRA	53/53	60/60	55/54	292	56/56	60/60	60/59	296
	460-3-60	STD	24	30	25	113	26	30	27	115
		MED	25	30	26	115	27	30	28	117
		HIGH	26	30	28	141	28	30	30	143
		ULTRA	28	30	29	146	30	35	31	148
	575-3-60	STD	20	25	21	84	24	25	25	88
		MED	21	25	22	88	24	30	26	92
		HIGH	22	25	23	97	25	30	27	101
		ULTRA	24	25	25	111	27	30	29	115
12	208/230-3-60	STD	51/51	60/60	52/52	252	54/54	60/60	56/56	256
		MED	54/54	60/60	56/55	302	58/58	70/70	61/59	306
		HIGH	57/57	70/70	59/58	313	61/61	80/80	64/63	317
	460-3-60	STD	26	30	27	126	27	30	29	128
		MED	27	30	28	152	29	35	30	154
		HIGH	29	35	30	157	30	35	32	159
	575-3-60	STD	22	25	23	107	26	30	27	111
		MED	23	25	24	116	27	30	28	120
		HIGH	25	30	26	130	29	30	30	134

See Legend and Notes on page 53.

## UNIT WIRE SIZING DATA WITH FACTORY-INSTALLED HACR BREAKER (PWRD C.O.) 6 TO 10 TONS

48LC UNIT	NOM. V-PH-HZ	IFM TYPE	W/ PWRD C.O.							
			NO P.E.				W/ P.E. (PWRD FR/ UNIT)			
			MCA	HACR BRKR	DISC. SIZE		MCA	HACR BRKR	DISC SIZE	
					FLA	LRA			FLA	LRA
07	208/230-3-60	STD	39/39	50/50	41/41	178	43/43	50/50	45/45	182
		MED	39/39	50/50	41/41	178	43/43	50/50	45/45	182
		HIGH	42/42	50/50	44/43	208	46/46	50/50	49/48	212
	460-3-60	STD	22	25	23	89	24	25	25	91
		MED	22	25	23	89	24	25	25	91
		HIGH	23	25	24	105	24	30	26	107
	575-3-60	STD	17	20	18	69	21	25	22	73
		MED	17	20	18	69	21	25	22	73
		HIGH	19	20	20	82	23	25	24	86
08	208/230-3-60	STD	47/47	60/60	49/49	205	51/51	60/60	54/53	209
		MED	48/48	60/60	51/50	209	52/52	60/60	55/55	213
		HIGH	52/52	60/60	55/54	259	56/56	60/60	59/58	263
		ULTRA	55/55	60/60	58/57	270	58/58	70/70	63/62	274
	460-3-60	STD	25	30	26	104	27	30	28	106
		MED	25	30	27	106	27	30	29	108
		HIGH	27	30	28	132	29	30	30	134
		ULTRA	28	30	30	137	30	35	32	139
	575-3-60	STD	21	25	22	80	24	30	26	84
		MED	21	25	23	84	25	30	27	88
		HIGH	22	25	24	93	26	30	28	97
		ULTRA	24	30	26	107	28	30	30	111
09	208/230-3-60	STD	50/50	60/60	52/52	232	53/53	60/60	56/56	236
		MED	51/51	60/60	53/53	236	55/55	60/60	58/57	240
		HIGH	55/55	60/60	58/56	286	58/58	70/70	62/61	290
		ULTRA	57/57	70/70	61/60	297	61/61	70/70	65/64	301
	460-3-60	STD	27	30	28	115	28	30	30	117
		MED	27	30	28	117	29	35	30	119
		HIGH	29	35	30	143	30	35	32	145
		ULTRA	30	35	32	148	32	35	34	150
	575-3-60	STD	22	25	23	86	25	30	27	90
		MED	22	25	24	90	26	30	28	94
		HIGH	23	25	25	99	27	30	29	103
		ULTRA	25	30	27	113	29	35	31	117
12	208/230-3-60	STD	55/55	60/60	58/57	257	59/59	70/70	62/62	261
		MED	59/59	70/70	62/61	307	63/63	80/80	66/65	311
		HIGH	62/62	80/80	65/64	318	66/66	80/80	69/68	322
	460-3-60	STD	28	30	29	128	30	35	31	130
		MED	29	35	31	154	31	35	33	156
		HIGH	31	35	33	159	33	40	35	161
	575-3-60	STD	24	25	25	109	28	30	29	113
		MED	25	30	26	118	29	30	30	122
		HIGH	26	30	28	132	30	35	32	136

See Legend and Notes on page 53.

Legend and Notes for pages 48 to 52.

LEGEND

<b>BRKR</b>	—	Circuit Breaker
<b>C.O.</b>	—	Convenience Outlet
<b>DISC</b>	—	Disconnect
<b>FLA</b>	—	Full Load Amps
<b>IFM</b>	—	Indoor Fan Motor
<b>LRA</b>	—	Locked Rotor Amps
<b>MCA</b>	—	Minimum Circuit Amps
<b>MOCP</b>	—	MAX FUSE or HACR Breaker
<b>P.E.</b>	—	Power Exhaust
<b>pwr'd fr/ unit</b>	—	Powered from Unit
<b>PWRD C.O.</b>	—	Powered Convenience Outlet
<b>UNPWR C.O.</b>	—	Unpowered Convenience Outlet

NOTES:

- In compliance with NEC requirements for multimotor and combination load equipment (refer to NEC Articles 430 and 440), the over-current protective device for the unit shall be fuse or HACR breaker. Canadian units may be fuse or circuit breaker.
- For 208/230 v units, where one value is shown it is the same for either 208 or 230 volts.
- Unbalanced 3-Phase Supply Voltage**  
Never operate a motor where a phase imbalance in supply voltage is greater than 2%. Use the following formula to determine the percentage of voltage imbalance.

$$\% \text{ Voltage Imbalance} = 100 \times \frac{\text{max voltage deviation from average voltage}}{\text{average voltage}}$$

Example: Supply voltage is 230-3-60



AB = 224 v  
BC = 231 v  
AC = 226 v

$$\text{Average Voltage} = \frac{(224 + 231 + 226)}{3} = \frac{681}{3} = 227$$

Determine maximum deviation from average voltage.

(AB) 227-224 = 3 v

(BC) 231-227 = 4 v

(AC) 227-226 = 1 v

Maximum deviation is 4 v.

Determine percent of voltage imbalance.

$$\% \text{ Voltage Imbalance} = 100 \times \frac{4}{227} = 1.78\%$$

This amount of phase imbalance is satisfactory as it is below the maximum allowable 2%.

**IMPORTANT:** If the supply voltage phase imbalance is more than 2%, contact your local electric utility company immediately.

## TYPICAL ELECTROMECHANICAL CONTROL WIRING DIAGRAM (48LC 07)

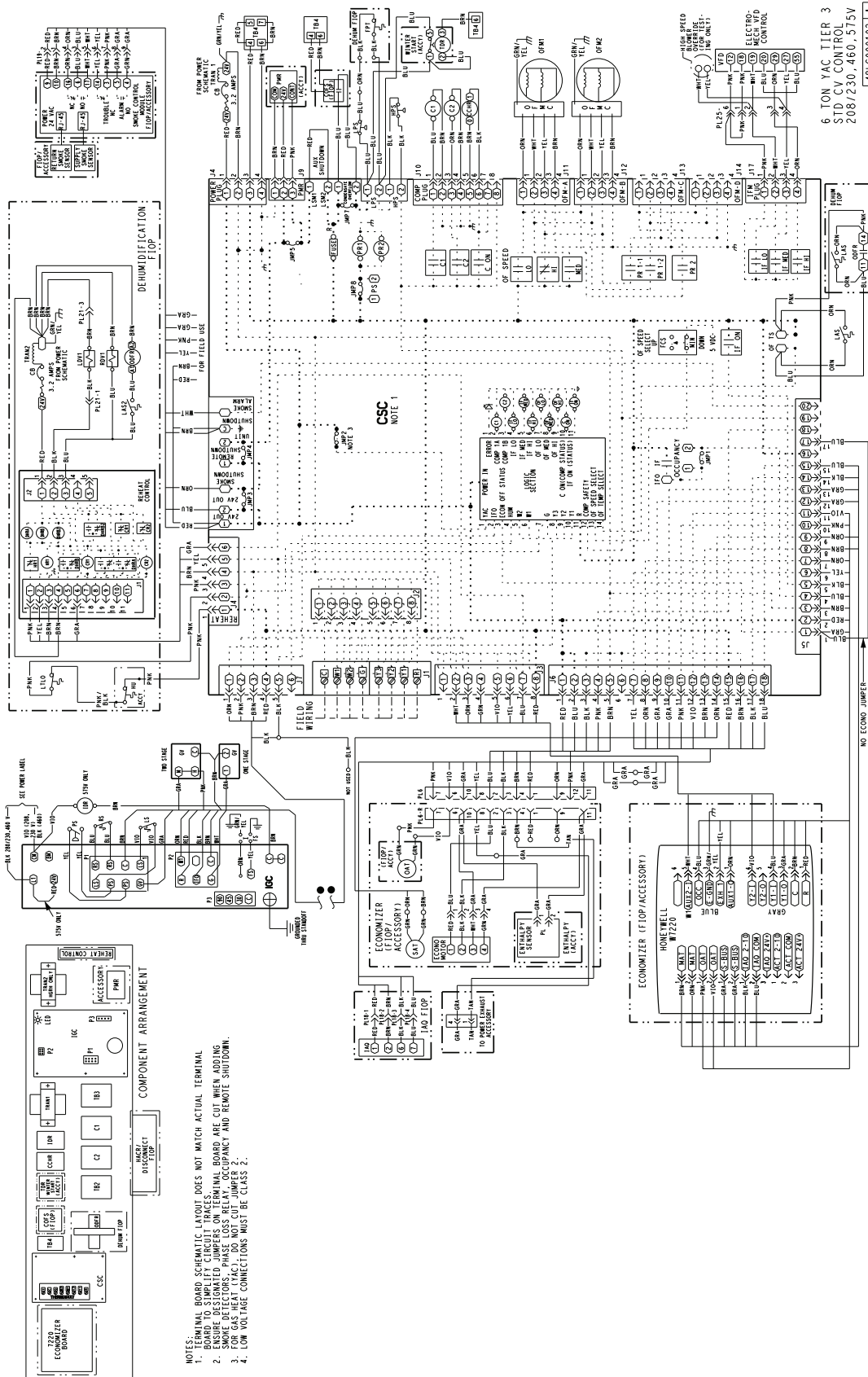

# SYSTEMVU™ CONTROL WIRING DIAGRAM (SIZE 07)

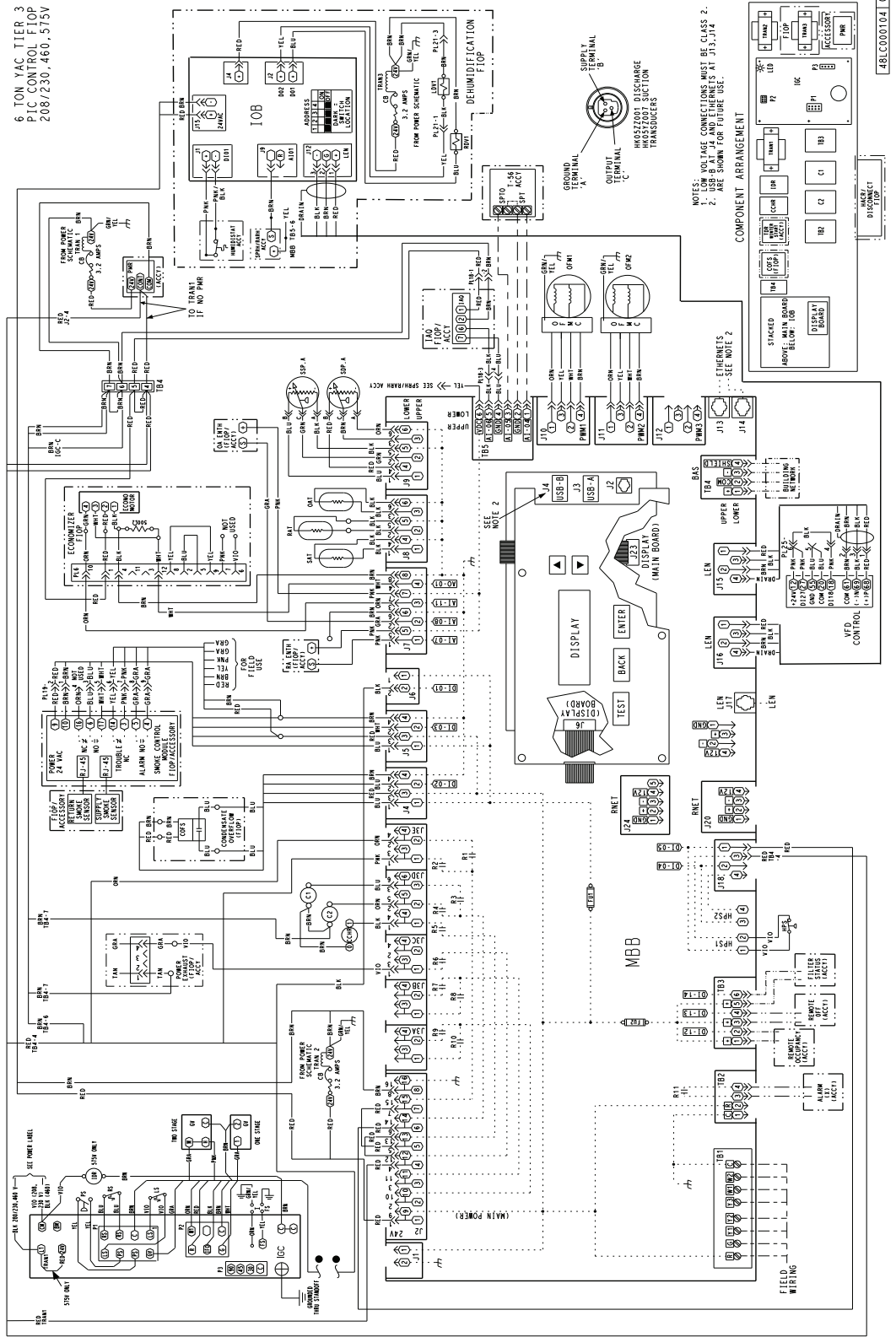

6 TON VAC TIER 3  
PIC CONTROL FLOP  
2087230.460.575V

NOTES: VOLTAGE CONNECTIONS MUST BE CLASS 2.  
1. SUS-B AT J4 AND LINES AT J13, J14  
2. ARE SHOWN FOR FUTURE USE.

COMPONENT ARRANGEMENT

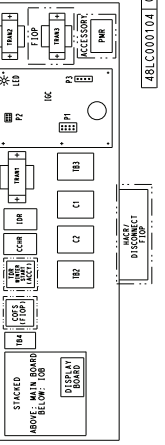

## RTU OPEN CONTROL WIRING DIAGRAM (SIZE 07)

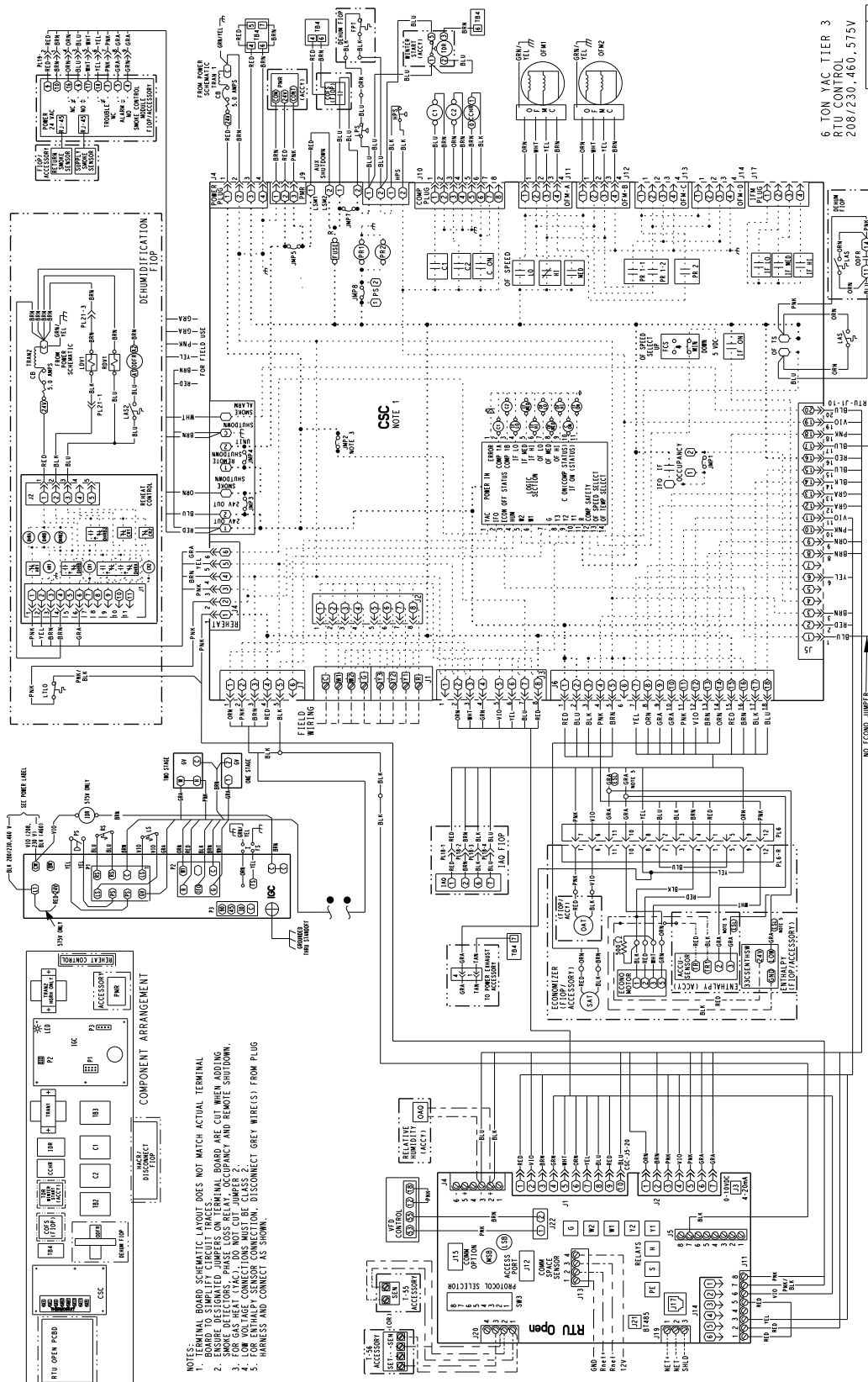



### TYPICAL ELECTROMECHANICAL CONTROL WIRING DIAGRAM (SIZES 08-12)

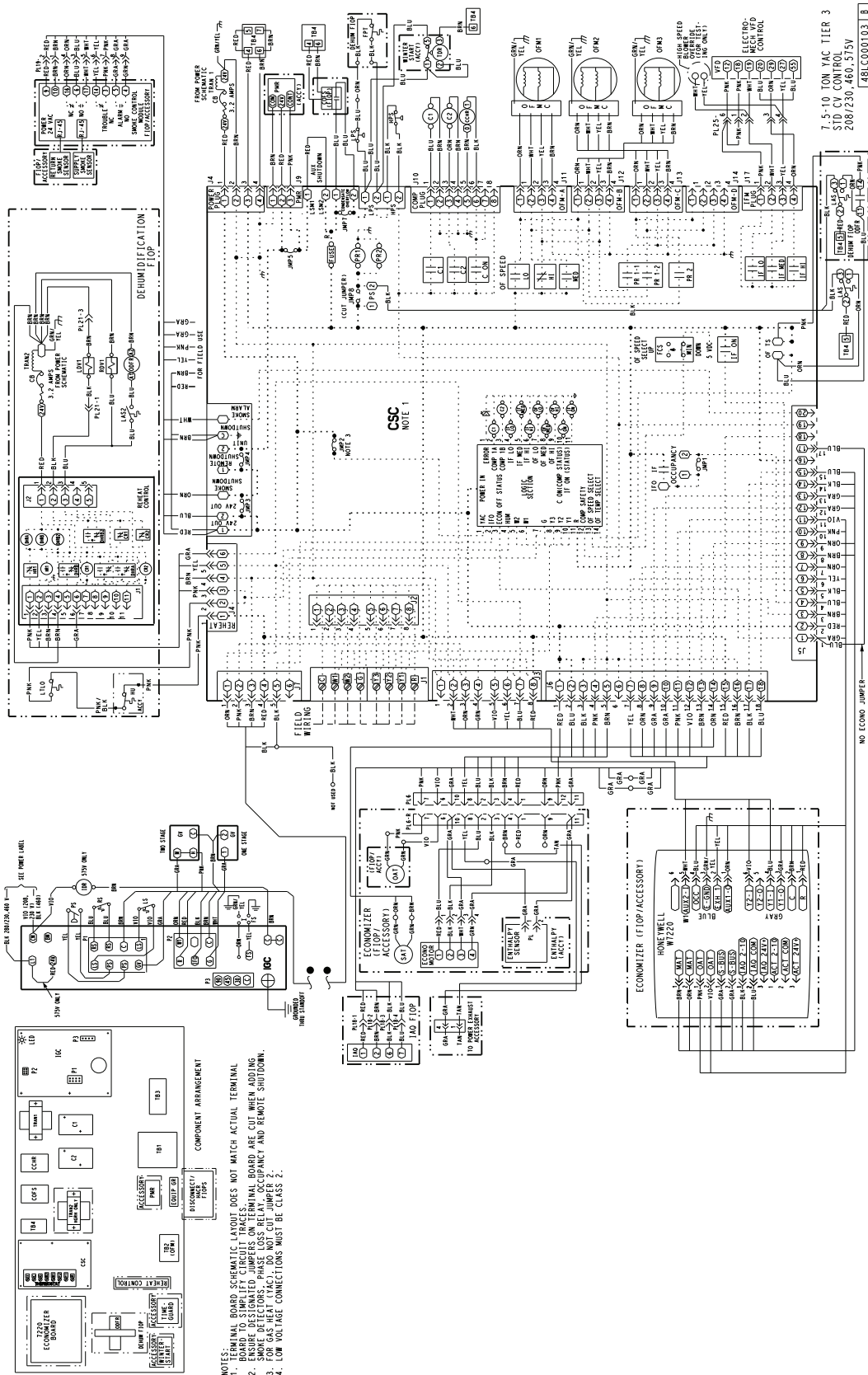

## SYSTEMVU™ CONTROL WIRING DIAGRAM (SIZES 08-12)

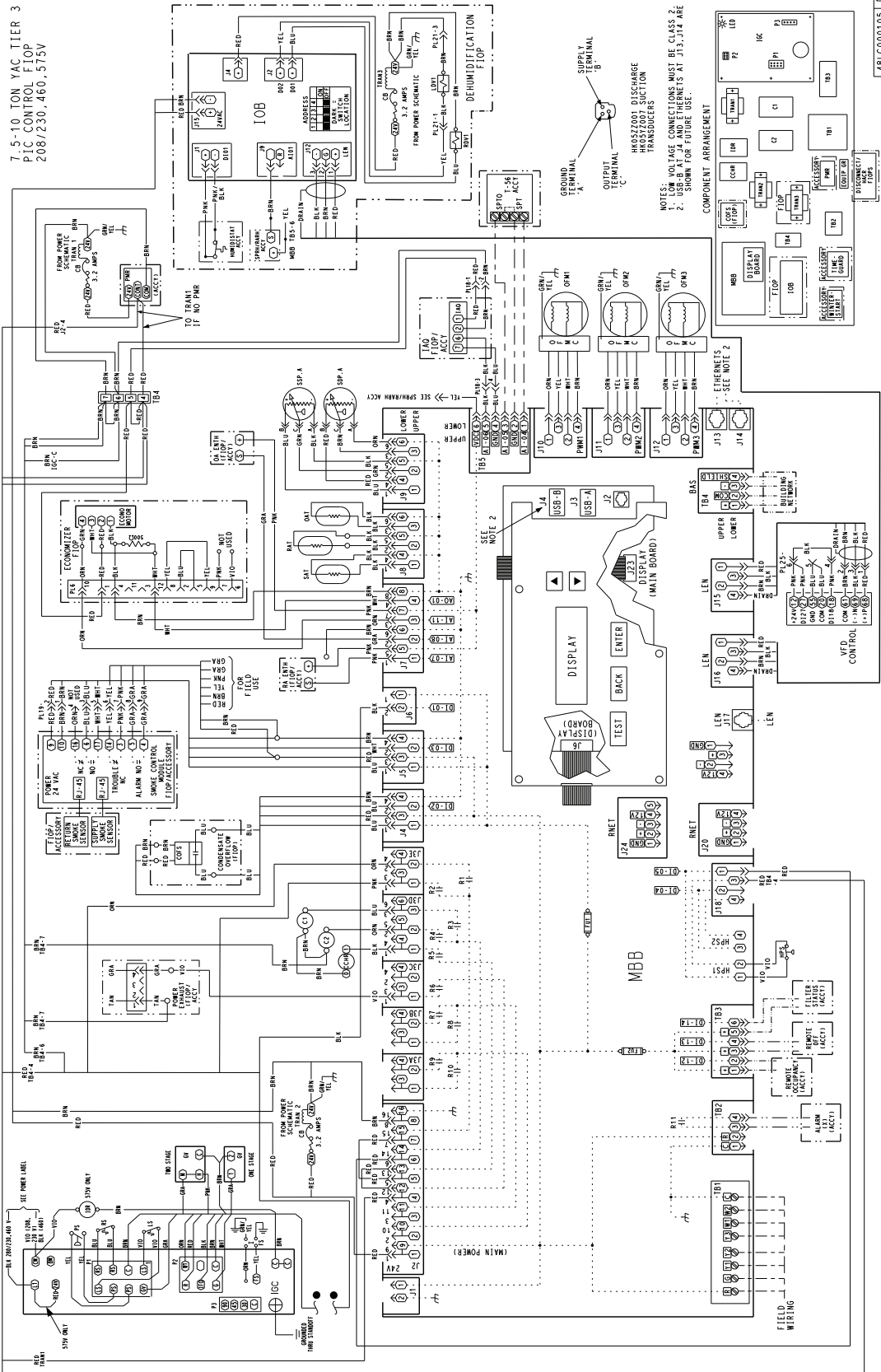

### RTU OPEN CONTROL WIRING DIAGRAM (SIZES 08-12)

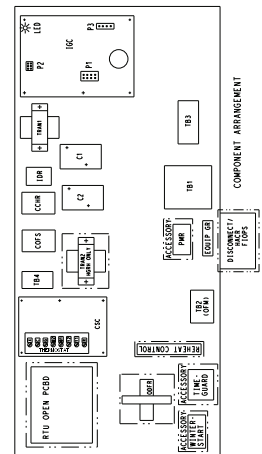
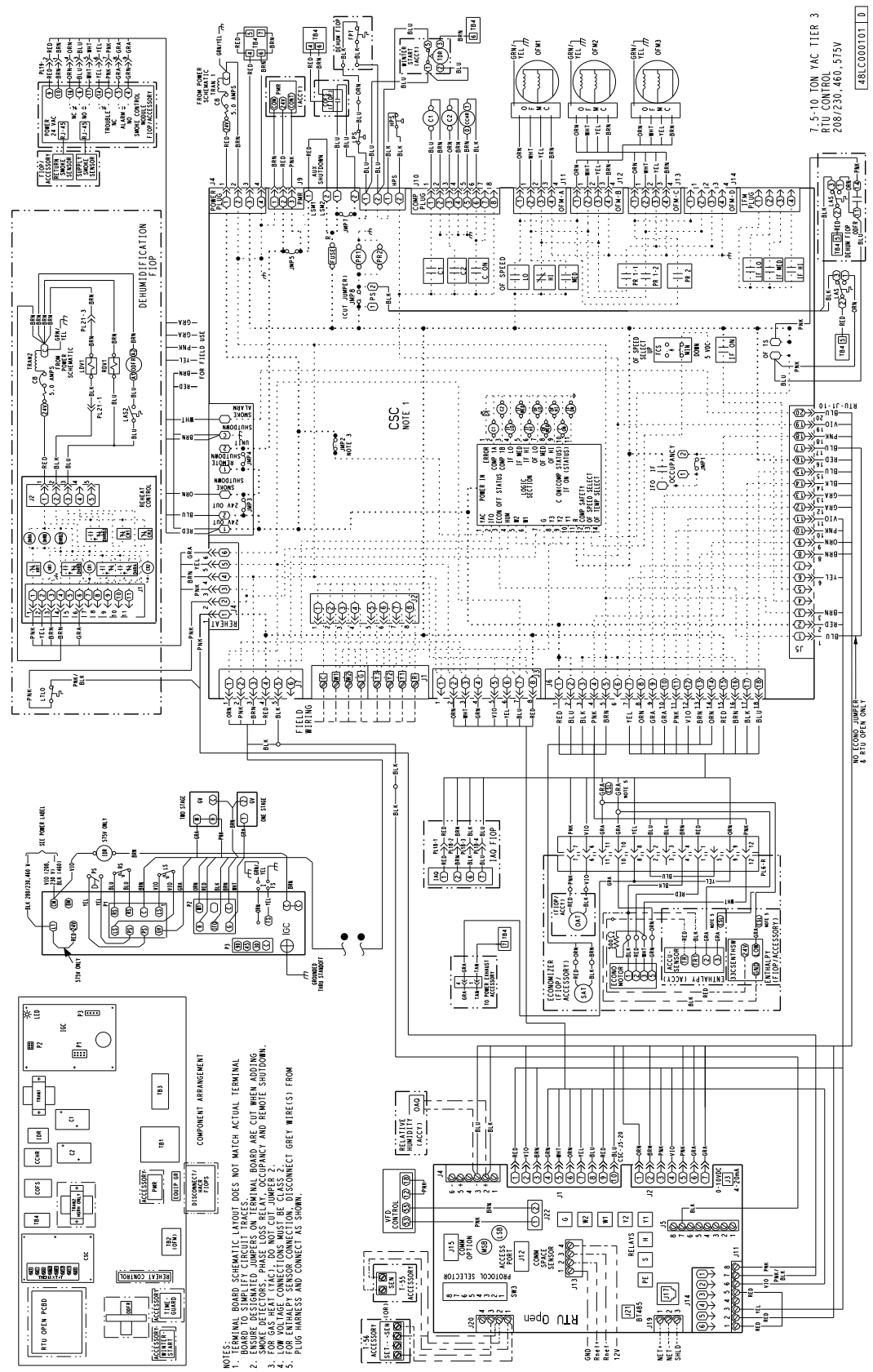

- NOTES:**
1. TERMINAL BOARD SCHEMATIC LAYOUT DOES NOT MATCH ACTUAL TERMINAL BOARD.
  2. ENSURE DESIGNATED JUMPERS ON TERMINAL BOARD ARE CUT WHEN ADDING DETECTORS.
  3. SMOKE LOSS RELAY, OCCUPANCY AND REMOTE SHUTDOWN.
  4. LOW VOLTAGE CONNECTIONS MUST BE CLASS 2.
  5. FOR ENTHALPY SENSOR CONNECTION, DISCONNECT GREY WIRE(S) FROM TERMINAL BOARD AND CONNECT AS SHOWN.

7.5-10 TON YAC TIER 3  
RTU CONTROL  
208/230, 460, 575V  
48LC000101 D

## TYPICAL POWER WIRING DIAGRAM (SIZE 07)

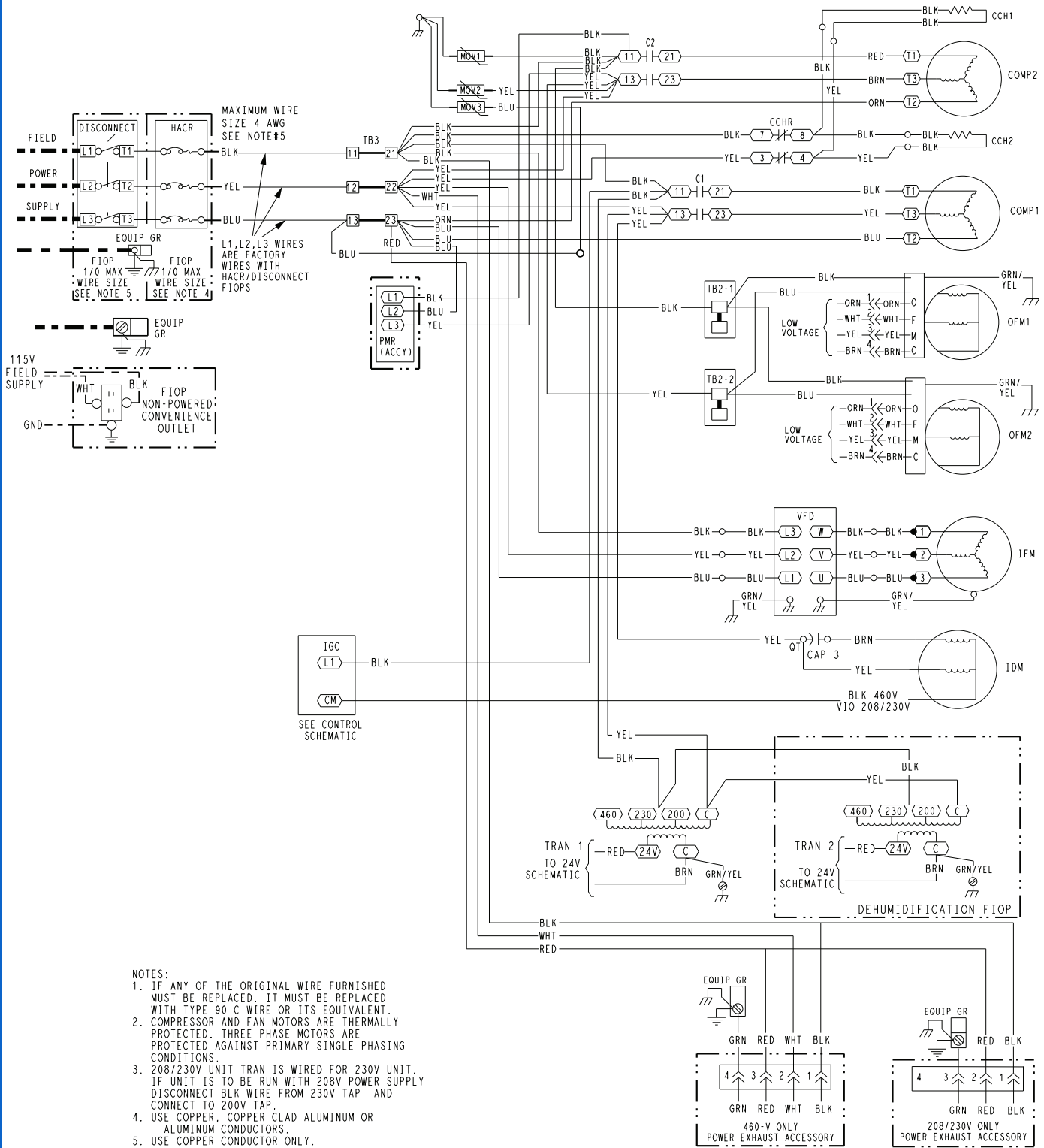

NOTE: Power wiring diagram is typical for electromechanical, SystemVu™, and RTU Open units.

YAC POWER TIER3 - 6 TON 208/230, 460V 3Ø

48LC500463 E

### TYPICAL POWER WIRING DIAGRAM (SIZES 08-12)

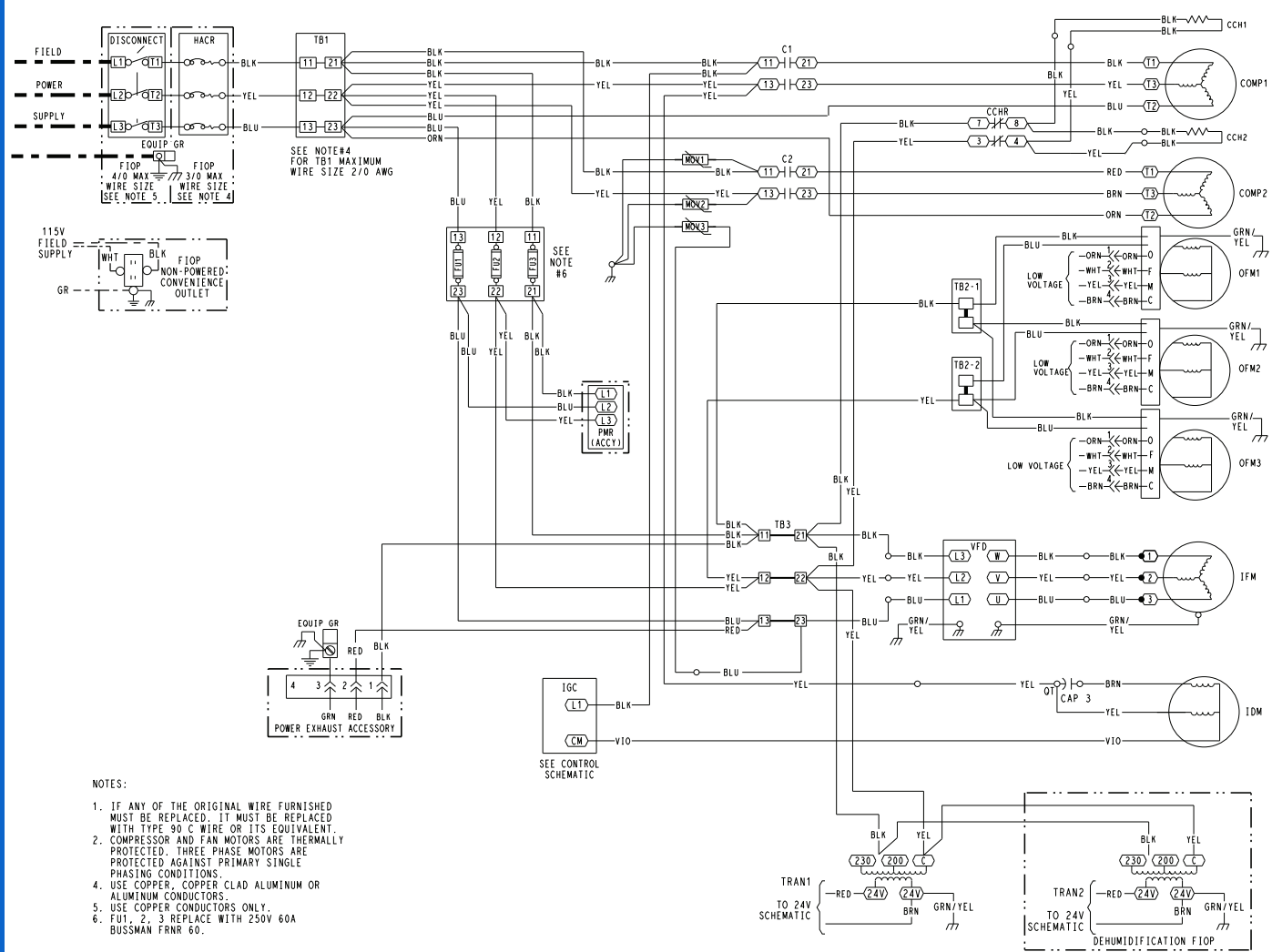

- NOTES:
1. IF ANY OF THE ORIGINAL WIRE FURNISHED MUST BE REPLACED, IT MUST BE REPLACED WITH TYPE 90 C WIRE OR ITS EQUIVALENT.
  2. COMPRESSOR AND FAN MOTORS ARE THERMALLY PROTECTED. THREE PHASE MOTORS ARE PROTECTED AGAINST PRIMARY SINGLE PHASING CONDITIONS.
  3. USE COPPER, COPPER CLAD ALUMINUM OR ALUMINUM CONDUCTORS.
  4. USE COPPER CONDUCTORS ONLY.
  5. FUSE 2, 3 REPLACE WITH 250V 60A BUSSMAN FNR 60.

NOTE: Power wiring diagram is typical for electromechanical, SystemVu™, and RTU Open units.

YAC POWER TIER3-7.5,8.5,10 TON  
208/230V 3Ø  
48LC500457 B

## General

The Integrated Staging Controller (ISC) is intended for use with a standard thermostat capable of three cooling stages. After initial power to the board, a Green LED will blink with a 1 second duty cycle indicating the unit is running properly. When the unit is not running properly, the Green LED will blink along with Red LED lights. The Red LED light configuration will indicate the type of error the board has identified.

The ISC board can be remotely shutdown by removing Jumper 4 and wiring to the Remote Shutdown terminal. The Smoke Control Module can shutdown the unit by removing Jumper 3 and wiring to the Smoke Shutdown terminal. A smoke alarm can be obtained by wiring to the Smoke Alarm terminal.

The crankcase heater will run at all times except when the compressors are running. An auxiliary power supply (24 Vac) available at TB-4 Terminal is provided to power auxiliary equipment. An optional Phase Monitor Relay can be wired to the PMR terminal by removing Jumper 5.

## Ventilation

In the Ventilation/Fan Mode (G on the thermostat), the indoor fan will run at low speed and the damper will operate at minimum position.

## Cooling

In the Cooling Mode, the small and large compressors will be sequenced to maintain the thermostat/DDC temperature setpoint. The table below shows the cooling operation based on the following conditions.

The outdoor fan and VFD-controlled indoor fan will operate at low and high speed. The indoor fan speed (rpm) is

factory set by the CFM and static pressure requirements for the unit installed.

## Humidi-MiZer® (Optional)

In the Dehumidification Mode, both compressors will run and Indoor airflow will be rise to High Speed.

In subcooling mode (reheat-1), during part load conditions when the room temperature and humidity are above the set point, the unit initiates the sub-cooling mode of operation; a call for cooling and dehumidification. RDV (Reheat Discharge Valve) and TWV (Three Way Valve) close; Indoor and Outdoor airflow will rise until reaching 100% of Speed.

At hot-gas reheat mode (reheat-2), when there is a call for dehumidification without a call for cooling, a portion of the hot gas from the compressor bypasses the condenser coil when RDV opens and hot gas is fed into the liquid line, TWV closes in this mode and the system provides mainly latent cooling. Indoor airflow will rise until reaching 100% of Speed, Outdoor airflow will run at High speed as long as outdoor temperature is above 80°F (26.7°C); when operating in this mode below 80°F (26.7°C) OAT, the system outdoor fan will operate as shown in the table below based on size.

48LC SIZE	RPM	NUMBER OF FANS ON	NUMBER OF FANS OFF
07	250	2	0
08	160	2	1
09	160	2	1
12	160	2	1

## COOLING OPERATION

INPUT	OUTPUT			
	Compressor C1	Compressor C2	Indoor Fan Speed	Outdoor Fan Speed
Thermostat				
First Stage Cooling (Y1)	On	Off	Low	Low (700 rpm)
Second Stage Cooling (Y2)	Off	On	Low	Medium (800 rpm)
Third Stage Cooling (Y3)	On	On	High	High (1,000 rpm)

### HUMIDI-MIZER® PIPING SCHEMATIC - NORMAL COOLING

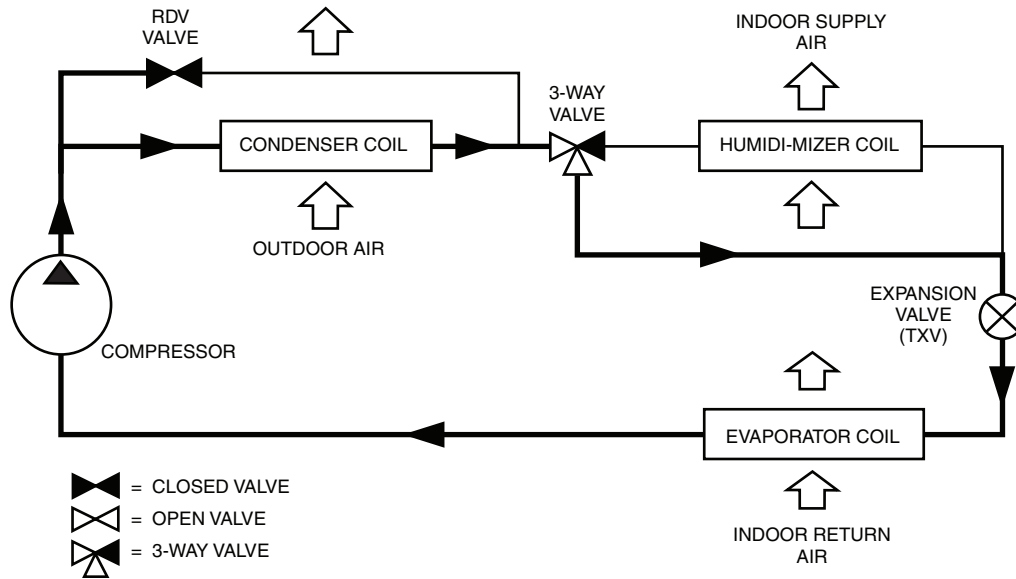

### HUMIDI-MIZER PIPING SCHEMATIC - SUBCOOLING MODE (REHEAT 1)

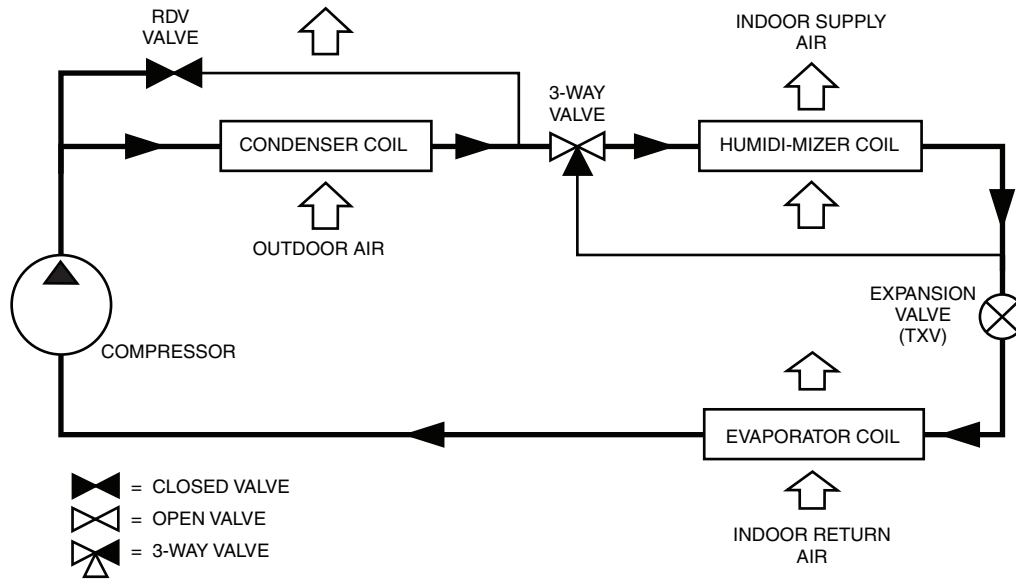

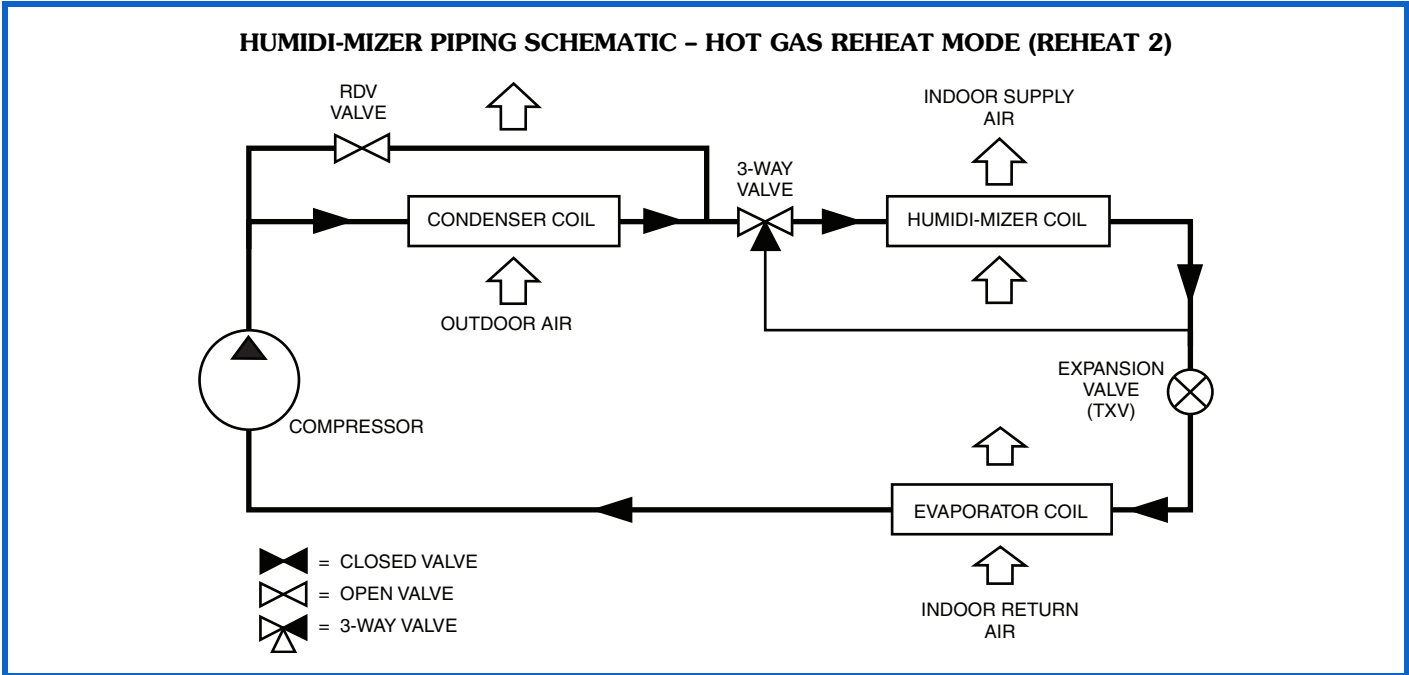



### Economizer (Optional)

When the Economizer DDC is in Free Cooling Mode and a demand for cooling exists (Y1 on the thermostat), the Economizer DDC will modulate the outdoor-air damper to provide a 50°F (10°C) to 55°F (13°C) mixed-air temperature into the zone and run the indoor-fan at high speed. As mixed-air temperature fluctuates above 55°F (13°C) or below 50°F (10°C) dampers will be modulated (open or close) to bring the mixed-air temperature back within control. Upon more call for cooling (Y2 on the thermostat), the outdoor-air damper will maintain its current position, compressor C1 will run and the outdoor fan will run at low speed. If there is further demand for cooling, the outdoor-air damper will maintain its current position, only compressor C2 will run and the outdoor fan will run at medium speed. The VFD-controlled indoor fan will operate at high speed regardless of the cooling demand.

If the increase in cooling capacity causes the mixed-air temperature to drop below 45°F (7°C), the outdoor-air damper will return to the minimum position. If the mixed-air temperature continues to fall, the outdoor-air damper will close. Control returns to normal once the mixed air temperature rises above 48°F (9°C). The power exhaust fans will be energized and de-energized, if installed, as the outdoor-air damper opens and closes.

If field-installed accessory CO<sub>2</sub> sensors are connected to the Economizer DDC, a demand controlled ventilation strategy will begin to operate. As the CO<sub>2</sub> level in the zone increases above the CO<sub>2</sub> setpoint, the minimum position of the damper will be increased proportionally. As the CO<sub>2</sub> level decreases because of the increase of fresh air, the outdoor-air damper will be proportionally closed. For economizer operation, there must be a thermostat call for the fan (G). If the unit is occupied and the fan is on, the damper will operate at minimum position. Otherwise, the damper will be closed.

### Low Ambient

In Low Ambient RTU conditions when the temperature is less than 55°F (13°C), the Low Ambient Switch (LAS) will be active and the outdoor-fans will run to the pre-set factory outdoor fan speed. When the temperature is greater than 65°F (18°C), the Low Ambient Switch will deactivate and the outdoor fans will run in the standard cooling mode. If the Outdoor Fan Select Switch is in the up position, the outdoor fans will run in the Fan Cycle Speed Mode (FCS) set to 250 rpm. If the Outdoor Fan Select Switch is in the down position, the outdoor fans will run in the Minimum Fan Speed Mode (MIN) set to 160 rpm regardless of the cooling demand.

48LC Size 07 units have a SPST normally open Low Ambient Switch wired across the TS and OF terminal and a jumper placed across the PS terminal (See the SPST schematic). When the LAS is active, the switch will close making contact to the OF terminal. This is done for units that require all outdoor fans to run at the same factory pre-set low ambient speed.

48LC Size 08 through 12 Units have a SPDT Low Ambient Switch wired to the OF terminal and the Outdoor Fan

Relay (See “SPDT Low Ambient Switch”). The jumper across the PS terminal will be removed. When the LAS is active, the switch will close making contact to the OF terminal and will drop connection to the ODF Relay. When electrical connection is removed from the ODF Relay, the PS connection will be opened. This will place the third outdoor fan electrically isolated from receiving any speed command, which will then turn the motor off. This is done for units that only require two outdoor fans to run at the same pre-set factory Low Ambient Speed.

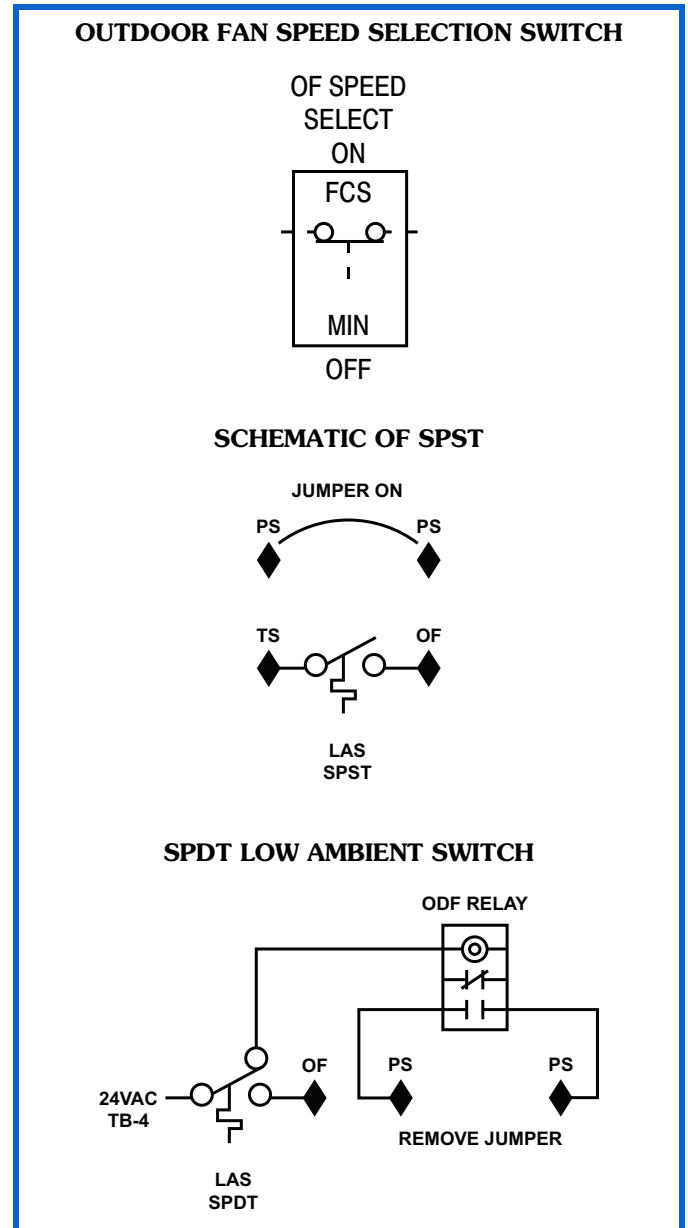

The Low Ambient Outdoor Fan Control table on page 66 shows the operation of the outdoor fans for each unit.

## LOW AMBIENT TEMPERATURE OUTDOOR FAN CONTROL

48LC SIZE	NUMBER OF FANS ON	NUMBER OF FANS OFF	SWITCH	OUTDOOR FAN SELECTION SWITCH	RPM
07	2	0	(1) SPST	Up	250
08	2	1	(1) SPDT	Down	160
09	2	1	(1) SPDT	Down	160
12	2	1	(1) SPDT	Down	160

### Heating

In the Heating Mode (W1 on the thermostat), the ISC board sends power to W on the IGC board. The ISC board sees W1=ON and also expects IFO=ON. However, the IFO is not ON immediately as the Integrated Gas Controller (IGC) board has to work through its operating sequence. Thus, the ISC board will turn on a momentary LED (light-emitting diode). The indoor fan is not turned on by the ISC board.

The IGC board starts its gas ignition process. An LED on the IGC board turns on and remains on during normal operation. A check is made to ensure that the rollout switch and limit switch are closed. If the check was successful, the induced draft motor is energized, and when its speed is satisfactory, as proven by the flue gas pressure switch, the ignition activation period begins. The burners will ignite within 5 seconds. If the burners do not light, there is a 22 second delay before another 5 second attempt. This sequence is repeated for 15 minutes or until the burners light. If, after the 15 minutes, the burners still have not lit, heating is locked out. To reset the control, break 24 VAC power to the thermostat.

When gas ignition occurs, the IGC board will continue to monitor the condition of the rollout switch, the limit switches, the flue gas pressure switch, as well as the flame sensor. Once gas ignition is confirmed, the IGC board has a 45 second built in delay before it sends an IFO=ON signal to the ISC board. Assuming the unit is controlled through a room thermostat set for fan auto, the indoor fan motor will energize and the outdoor-air dampers will open to their minimum position. The delay will allow for the gas section to come to temperature before turning on the indoor fan. This will prevent the unit from blowing cold air into the space. Once the ISC board sees IFO=ON, the VFD-controlled indoor fan is set to high speed and the LED error is cleared. If, for some reason the over temperature limit opens prior to the start of the indoor fan blower, the unit will shorten the 45 second delay to 5 seconds less than the time from initiation of heat to when the limit tripped. Gas will not be interrupted to the burners and heating will continue. Once the fan ON delay has been

modified, it will not change back to 45 seconds until power is reset to the control.

When W1 is turned OFF, the IGC board turns off the gas valve. The IGC board has a delay time before it turns IFO=OFF. At this time, the ISC board sees W1=OFF and IFO=ON. The ISC will keep the indoor fan ON. Once the IGC board delay times out, the ISC board will see W1=OFF and IFO=OFF, which then turns the indoor fan OFF.

If the call for W1 lasted less than 1 minute, the heating cycle will not terminate until 1 minute after W1 became active. If the unit is controlled through a room thermostat set for fan auto, the indoor fan motor will continue to operate for an additional 45 seconds then stop. If the overtemperature limit opens after the indoor motor is stopped, but within 10 minutes of W1 becoming inactive, on the next cycle the time will be extended by 15 seconds. The maximum delay is 3 minutes. Once modified, the fan OFF delay will not change back to 45 seconds unless power is reset to the control. A LED indicator is provided on the IGC to monitor operation.

When additional heat is required, W2 closes and initiates power to the second stage of the main gas valve. When the thermostat is satisfied, the gas valve closes, interrupting the flow of gas to the main burners.

### SystemVu™ Control (Factory Option)

For details on operating 48LC units equipped with the factory installed SystemVu controls option, refer to the *48/50LC 07-26 Single Package Rooftop Units with SystemVu Controls Version 1.X and Puron® (R-410A) Refrigerant Controls, Start-Up, Operation and Troubleshooting manual*.

### RTU Open (Factory Option)

For details on operating 48LC units equipped with the factory installed RTU Open option, refer to the *48/50LC 07-26 Factory Installed Option RTU Open Multi-Protocol Controller Controls, Start-Up, Operation and Troubleshooting manual*.

## Min operating ambient temp (cooling)

In mechanical cooling mode, your Carrier rooftop unit can safely operate down to an outdoor ambient temperature of 40°F (4°C). An economizer shall be the source of cooling in low ambient conditions. When the outside air temperature is below 40°F (4°C), to improve system reliability, reduce energy usage, and improve system efficiency, mechanical cooling shall not be utilized. Therefore, an economizer shall be used in these conditions to provide efficient low ambient cooling. Using an economizer for low ambient cooling merely requires fan energy to satisfy space requirements. The compressors shall not be required to run which will provide exceptional energy savings due to less power draw, improved system reliability due to fewer compressor run hours, improved reliability through fewer starts/stops, and lower life cycle costs due to reduced compressor maintenance.

## Max operating ambient temp (cooling)

The maximum operating ambient temperature for cooling mode is 125°F (52°C). While cooling operation above 125°F (52°C) may be possible, it could cause either a reduction in performance, reliability, or a protective action by the unit's internal safety devices.

## Min mixed air temp (heating)

Using the factory settings, the minimum temperatures for the mixed air (the combined temperature of the warm return air and the cold outdoor air) entering the dimpled, gas heat exchangers are:

ALUMINIZED	STAINLESS STEEL
50°F (10°C) continuous	40°F (4°C) continuous
45°F (7°C) intermittent	35°F (2°C) intermittent

Operating at lower mixed-air temperatures may be possible, if a field-supplied, outdoor air thermostat initiates both heat stages when the temperature is less than the minimum temperatures listed above. Please contact your local Carrier representative for assistance.

## Min and max airflow (heating and cooling)

To maintain safe and reliable operation of your rooftop, operate within the heating airflow limits during heating mode and cooling airflow limits during cooling mode. Operating above the max may cause blow-off, undesired airflow noise, or airflow related problems with the rooftop unit. Operating below the min may cause problems with coil freeze-up and unsafe heating operation. For proper minimum and maximum CFM values, see relevant tables on pages 5-6.

## Heating-to-cooling changeover

Your unit will automatically change from heating to cooling mode when using a thermostat or sensor with an auto-change-over feature.

## Airflow

All units are draw-through in cooling mode and blow-through in heating mode.

## Outdoor air application strategies

Economizers reduce operating expenses and compressor run time by providing a free source of cooling and a means of ventilation to match application changing needs. In fact, they should be considered for most applications. Also, consider the

various economizer control methods and their benefits, as well as sensors required to accomplish your application goals. Please contact your local Carrier representative for assistance.

## Motor limits, break horsepower (BHP)

Due to internal design of Carrier units, the air path, and specially designed motors, the full horsepower (maximum continuous BHP) band, as listed in the physical data table on page 7, can be used with the utmost confidence. There is no need for extra safety factors, as Carrier motors are designed and rigorously tested to use the entire, listed BHP range without either nuisance tripping or premature motor failure.

## Propane heating

Propane has different physical qualities than natural gas. As a result, propane requires different fuel to air mixture. To optimize the fuel/air mixture for propane, Carrier sells different burner orifices in an easy to install accessory kit. To select the correct burner orifices or determine the heat capacity for a propane application, use either the selection software or the unit's service manual.

## High altitude heating

High altitudes have less oxygen, which affects the fuel/air mixture in heat exchangers. In order to maintain a proper fuel/air mixture, heat exchangers operating in altitudes above 2000 ft (610 m) require different orifices. To select the correct burner orifices or determine the heat capacity for a high altitude application, use either the selection software or the unit's service manual.

High altitudes have less oxygen, which means heat exchangers need less fuel. The new gas orifices in this field-installed kit make the necessary adjustment for high altitude applications. They restore the optimal fuel to air mixture and maintain healthy combustion on altitudes above 2000 ft (610 m).

NOTE: Typical natural gas heating value ranges from 975 to 1050 Btu/ft<sup>3</sup> at sea level nationally. The heating value goes down approximately 1.7% per every thousand feet elevation. Standard factory orifices can typically be used up to 2000 ft (610 m) elevation without any operational issues.

## Sizing a rooftop

Bigger isn't necessarily better. While an air conditioner needs to have enough capacity to meet the design loads, it doesn't need excess capacity. In fact, excess capacity typically results in very poor part load performance and humidity control.

Using higher design temperatures than ASHRAE recommends for your location, adding "safety factors" to the calculated load, are all signs of oversizing air conditioners. Oversizing the air conditioner leads to poor humidity control, reduced efficiency, higher utility bills, larger indoor temperature swings, excessive noise, and increased wear and tear on the air conditioner.

Rather than oversizing an air conditioner, engineers should "right-size" or even slightly undersize air conditioners. Correctly sizing an air conditioner controls humidity better; promotes efficiency; reduces utility bills; extends equipment life, and maintains even, comfortable temperatures. Please contact your local Carrier representative for assistance.

Note about this specification:

This specification is in the “Masterformat” as published by the Construction Specification Institute. Please feel free to copy this specification directly into your building spec.

## **WeatherExpert® Ultra High-Efficiency Gas Heat/ Electric Cooling Packaged Rooftop**

### **HVAC Guide Specifications:**

Size Range: 6 to 10 Nominal Tons

#### **Part 1 — 23 06 80 Schedules for Decentralized HVAC Equipment**

1.01 23 06 80.13 Decentralized Unitary HVAC Equipment Schedule

A. 23 06 80.13.A. Rooftop unit schedule

1. Schedule is per the project specification requirements.

#### **Part 2 — 23 07 16 HVAC Equipment Insulation**

2.01 23 07 16.13 Decentralized, Rooftop Units:

A. 23 07 16.13.A. Evaporator fan compartment:

1. Interior cabinet surfaces shall be insulated with a minimum 1/2-in. thick, minimum 1 1/2 lb density aluminum foil-faced insulation on the air side.
2. Insulation and adhesive shall meet NFPA 90A requirements for flame spread and smoke generation.
3. Unit internal insulation linings shall be resistant to mold growth in accordance with “mold growth and humidity” test in ASTM C1338, G21, and UL 181 or comparable test method. Air stream surfaces shall be evaluated in accordance with the “Erosion Test” in UL 181, as part of ASTM C1071.

B. 23 07 16.13.B. Gas heat compartment:

1. Aluminum foil-faced fiberglass insulation shall be used.
2. Insulation and adhesive shall meet NFPA 90A requirements for flame spread and smoke generation.

#### **Part 3 — 23 09 13 Instrumentation and Control Devices for HVAC**

3.01 23 09 13.23 Sensors and Transmitters

A. 23 09 13.23.A. Thermostats

1. Thermostat must:
  - a. energize both “W” and “G” when calling for heat.
  - b. have capability to energize 3 different stages of cooling, and 2 different stages of heating.
  - c. include capability for occupancy scheduling.

#### **Part 4 — 23 09 23 Direct Digital Control (DDC) System for HVAC**

4.01 23 09 23.13 Decentralized, Rooftop Units:

A. 23 09 23.13.A. SystemVu™ intelligent integrated Direct Digital Control (DDC) shall provide:

1. Integrated unit operation for comfort cooling, heating ventilation as well as all monitoring,

recording and reporting capabilities. Controller shall also provide diagnostics and alarms of abnormal unit operation through the controller. Controller shall have an intuitive user display and be able to be used in a standalone operation or via building automation system (BAS).

2. Quick Unit Status LEDs:

- a. Run – indicates all systems are go.
- b. ALERT – indicates there is currently a non-critical issue with the unit, like filters need to be replaced.
- c. FAULT – indicates the unit has a critical issue and will possibly shut down.

3. Six large navigation keys for easy access. Navigation keys shall consist of: TEST, BACK, ENTER, and MENU along with UP and DOWN arrows.

4. Full back lit user display with 4 line by 30 character text capabilities. Display menu shall be designed to provide guided major menus and sub menus main menus provided below:

- a. Shutdown Unit
- b. Run Status
- c. Settings
- d. Alerts/Faults
- e. Service
- f. Inputs
- g. Outputs
- h. USB

5. The capability for standalone operation with conventional thermostat/sensor or use with building automation systems (BAS) of Carrier i-Vu®, BACnet<sup>1</sup> and Carrier Comfort Network® (CCN) systems. No special modules or boards are required for these capabilities.

6. The ability to read refrigerant pressures at display or via BAS network of Discharge Pressure and Suction Pressure. The need for traditional refrigerant gages is not required.

7. USB Data Port for flash drive interaction. This will allow the transfer of data for uploads, downloads, perform software upgrades, backup and restore data and file transfer data such as component number of starts and run hours.

8. Reverse Rotation Protection of compressors if field three phase wiring is misapplied.

9. Provide Service Capabilities of:

- a. Auto run test
- b. Manual run test
- c. Component run hours and starts
- d. Commissioning reports
- e. Data logging
- f. Alarm history

---

1. BACnet is a registered trademark of ASHRAE (American Society of Heating, Refrigerating, and Air-Conditioning Engineers).

10. Economizer control and diagnostics. Set up economizer operation, receive feedback from actuator. Also meets the most recent California Title 24 Fault Detection and Diagnostic (FDD) requirements.
  11. Unit cooling operation down to 0°F (–18°C).
  12. Controller shall have easy access connections around the controller perimeter area and consist of Mate-N-Lok<sup>1</sup>, terminal block and RJ style modular jack connections.
  13. 365-day real time clock, 20 holiday schedules along with occupied and unoccupied scheduling.
  14. Auto-Recognition for easy installation and commissioning of devices like economizers, space sensors, etc.
  15. A 5°F (2.8°C) temperature difference between cooling and heating setpoints to meet the latest ASHRAE 90.1-2013 Energy Standard.
  16. Contain return air sensor, supply air sensor and outdoor air sensor to help monitor and provide data for the unit comfort operation, diagnostic and alarms.
  17. Use of Carrier's field accessory hand-held Navigator™ display.
  18. Control of the operation of unit VFD (Variable Frequency Drive) to work in conjunction with the cooling, heating and ventilation modes.
  19. 3-year limited part warranty
- B. 23 09 23.13.B. RTU Open - multi-protocol, direct digital controller:
1. Shall be ASHRAE 62 compliant.
  2. Shall accept 18-30VAC, 50-60Hz, and consume 15VA or less power.
  3. Shall have an operating temperature range from –40°F (–40°C) to 130°F (54°C), 10% to 90% RH (non-condensing).
  4. Shall include built-in protocol for BACnet (MS/TP and PTP modes), Modbus<sup>2</sup> (RTU and ASCII), Johnson N2 and LonWorks<sup>3</sup>. LonWorks Echelon processor required for all Lon applications shall be contained in separate communication board.
  5. Shall allow access of up to 62 network variables (SNVT). Shall be compatible with all open controllers.
  6. Baud rate controller shall be selectable using a dipswitch.
  7. Shall have an LED display independently showing the status of serial communication, running, errors, power, all digital outputs, and all analog inputs.
8. Shall accept the following inputs: space temperature, setpoint adjustment, outdoor air temperature, indoor air quality, outdoor air quality, compressor lock-out, fire shutdown, enthalpy switch, and fan status/filter status/humidity/ remote occupancy.
  9. Shall provide the following outputs: economizer, fan, cooling stage 1, cooling stage 2, heat stage 1, heat stage 2, heat stage 3/ exhaust/ reversing valve.
  10. Shall have built-in surge protection circuitry through solid-state polyswitches. Polyswitches shall be used on incoming power and network connections. Polyswitches will return to normal when the “trip” condition clears.
  11. Shall have a battery back-up capable of a minimum of 10,000 hours of data and time clock retention during power outages.
  12. Shall have built-in support for Carrier technician tool.
  13. Shall include an RS-485 protocol communication port, an access port for connection of either a computer or a Carrier technician tool, an EIA-485 port for network communication to intelligent space sensors and displays, and a port to connect an optional LonWorks communications card.
  14. Software upgrades will be accomplished by either local or remote download. No software upgrades through chip replacements are allowed.

**Part 5 — 23 09 33 Integrated Staging Control (ISC) Board System for HVAC (Electro-Mechanical units)**

5.01 23 09 33.13 Decentralized, Rooftop Units:

A. 23 09 33.13.A. General:

1. Shall be complete with self-contained low-voltage control circuit protected by a resettable circuit breaker on the 24-v transformer side. Transformer shall have 75VA capability.
2. Shall utilize color-coded wiring.
3. Shall include an ISC electro-mechanical control board, to conveniently and safely provide connection points for vital control functions such as: smoke detectors, phase monitor, gas controller, economizer, thermostat, and safety switches. Shall control all three stages of compressor logic, two or three stages of the indoor fan motor logic as well as staging of the outdoor fan motor. Shall also have a green LED indicator to indicate GO operation as well as a fault LED indicator for thermostat mis-wiring, no fan operation and safety switches.  
NOTE: Does not apply to units equipped with SystemVu™ controls.
4. The heat exchanger shall be controlled by an integrated gas controller (IGC) microprocessor. See heat exchanger section of this specification.

---

1. Mate-N-Lok is a registered trademark of The Whittaker Corporation.  
 2. Modbus is a registered trademark of Schneider Electric.  
 3. LonWorks is a registered trademark of Echelon Corporation.

## B. 23 09 33.13.B. Safeties:

1. Compressor over-temperature, over-current. High internal pressure differential.
2. Low-pressure protection:
  - a. Low-pressure switch shall use different color wire than the high-pressure switch. The purpose is to assist the installer and service technician to correctly wire and or trouble-shoot the rooftop unit.  
NOTE: Does not apply to units equipped with SystemVu controls.
3. High-pressure protection:
  - a. High-pressure switch shall use different color wire than the low-pressure switch. The purpose is to assist the installer and service technician to correctly wire and or trouble-shoot the rooftop unit.
4. Automatic reset, motor thermal overload protector.
5. Heating section shall be provided with the following minimum protections:
  - a. High-temperature limit switches.
  - b. Induced draft motor speed sensor.
  - c. Flame rollout switch.
  - d. Flame proving controls.

## Part 6 — 23 09 93 Sequence of Operations for HVAC Controls

### 6.01 23 09 93.13 Decentralized, Rooftop Units:

- A. 23 09 93.13.A. INSERT SEQUENCE OF OPERATION

## Part 7 — 23 40 13 Panel Air Filters

### 7.01 23 40 13.13 Decentralized, Rooftop Units:

- A. 23 40 13.13.A. Standard filter section:
  1. Shall consist of factory-installed, low velocity, disposable 2-in. thick fiberglass filters of commercially available sizes.
  2. Unit shall use only one filter size. Multiple sizes are not acceptable.
  3. Filters shall be accessible through an access panel with “no-tool” removal as described in the unit cabinet section of this specification (23 81 19.13.G).

## Part 8 — 23 81 19 Self-Contained Air Conditioners

### 8.01 23 81 19.13 Small-Capacity Self-Contained Air Conditioners (48LC\*\*07-12)

- A. 23 81 19.13.A. General
  1. Outdoor, rooftop mounted, DDC electrically controlled, heating and cooling unit utilizing fully hermetic scroll compressors for cooling duty and gas combustion for heating duty.
  2. Factory assembled, single-piece heating and cooling rooftop unit. Contained within the unit enclosure shall be all factory wiring, piping, controls, and special features required prior to field start-up.

3. Unit shall use Puron® (R-401A) refrigerant.
4. Unit shall be installed in accordance with the manufacturer’s instructions.
5. Unit must be selected and installed in compliance with local, state, and federal codes.

## B. 23 81 19.13.B. Quality Assurance

1. Unit meets and exceeds ASHRAE 90.1-2013 minimum efficiency requirements.
  2. Unit shall be rated in accordance with AHRI Standards 340/360.
  3. Unit shall be designed to conform to ASHRAE 15, 2001.
  4. Unit shall be ETL/UL-tested and certified in accordance with ANSI Z21.47 Standards and UL-listed and certified under Canadian standards as a total package for safety requirements.
  5. Insulation and adhesive shall meet NFPA 90A requirements for flame spread and smoke generation.
  6. Unit internal insulation linings shall be resistant to mold growth in accordance with “mold growth and humidity” test in ASTM C1338, G21, and UL 181 or comparable test method. Air stream surfaces shall be evaluated in accordance with the “Erosion Test” in UL 181, as part of ASTM C1071.
  7. Unit casing shall be capable of withstanding 500 hour salt spray exposure per ASTM B117 (scribed specimen).
  8. Roof curb shall be designed to conform to NRCA Standards.
  9. Unit shall be subjected to a completely automated run test on the assembly line. The data for each unit will be stored at the factory, and must be available upon request.
  10. Unit shall be designed in accordance with UL Standard 1995, including tested to withstand rain.
  11. Unit shall be constructed to prevent intrusion of snow and tested to prevent snow intrusion into the control box up to 40 mph.
  12. Unit shake tested to assurance level 1, ASTM D4169 to ensure shipping reliability.
  13. High-Efficiency Motors listed shall meet section 313 of the Energy Independence and Security Act of 2007 (EISA 2007).
- C. 23 81 19.13.C. Delivery, Storage, and Handling
    1. Unit shall be stored and handled per manufacturer’s recommendations.
    2. Lifted by crane requires either shipping top panel or spreader bars.
    3. Unit shall only be stored or positioned in the upright position.
  - D. 23 81 19.13.D. Project Conditions
    1. As specified in the contract.

E. 23 81 19.13.E. Operating Characteristics

1. Unit shall be capable of starting and running at 125°F (52°C) ambient outdoor temperature, meeting maximum load criteria of AHRI Standard 340/360 at ± 10% voltage.
2. Compressor with standard controls shall be capable of operation down to 40°F (4°C) ambient outdoor temperatures. For lower operation, an integrated economizer shall be utilized to allow lower temperatures and accommodate indoor air quality initiatives.
3. Unit shall discharge supply air vertically or horizontally as shown on contract drawings.
4. Unit shall be factory configured for vertical supply and return configurations.
5. Unit shall be field convertible from vertical to horizontal airflow on all models. No special kit required on 07 models. Field-installed supply duct kit required for 08-12 size models only.
6. Unit shall be capable of mixed operation: vertical supply with horizontal return or horizontal supply with vertical return.

F. 23 81 19.13.F. Electrical Requirements

1. Main power supply voltage, phase, and frequency must match those required by the manufacturer.

G. 23 81 19.13.G. Unit Cabinet

1. Unit cabinet shall be constructed of galvanized steel, and shall be bonderized and coated with a pre-painted baked enamel finish on all externally exposed surfaces.
2. Unit cabinet exterior paint shall be: film thickness, (dry) 0.003 inches minimum, gloss (per ASTM D523, 60°F / 16°C): 60, Hardness: H-2H Pencil hardness.
3. Evaporator fan compartment interior cabinet insulation shall conform to AHRI Standards 340/360 minimum exterior sweat criteria. Interior surfaces shall be insulated with a minimum 1/2-in. thick, 1 lb density, aluminum foil-faced fiberglass insulation. Aluminum foil-faced fiberglass insulation shall also be used in the gas heat compartment.
4. Unit internal insulation linings shall be resistant to mold growth in accordance with “mold growth and humidity” test in ASTM C1338, G21, and UL 181 or comparable test method. Air stream surfaces shall be evaluated in accordance with the “Erosion Test” in UL 181, as part of ASTM C1071.
5. Base of unit shall have a minimum of four locations for thru-the-base gas and electrical connections (factory-installed or field-installed), standard.
6. Base Rail:
  - a. Unit shall have base rails on a minimum of 4 sides.

- b. Holes shall be provided in the base rails for rigging shackles to facilitate maneuvering and overhead rigging.

- c. Holes shall be provided in the base rail for moving the rooftop by fork truck.

- d. Base rail shall be a minimum of 16 gage thickness.

7. Condensate Pan and Connections:

- a. Shall be an internally sloped condensate drain pan made of a non-corrosive material.

- b. Shall comply with ASHRAE Standard 62.

- c. Shall use a 3/4-in. -14 NPT drain connection, possible either through the bottom or side of the drain pan. Connection shall be made per manufacturer’s recommendations.

8. Top Panel:

- a. Shall be a single piece top panel on 07 sizes, two piece top on 08-12 sizes.

9. Gas Connections:

- a. All gas piping connecting to unit gas valve shall enter the unit cabinet at a single location on side of unit (horizontal plane).

- b. Thru-the-base capability

- 1.) Standard unit shall have a thru-the-base gas-line location using a raised, embossed portion of the unit basepan.

- 2.) Optional, factory-approved, water-tight connection method must be used for thru-the-base gas connections.

- 3.) No basepan penetration, other than those authorized by the manufacturer, is permitted.

10. Electrical Connections:

- a. All unit power wiring shall enter unit cabinet at a single, factory-prepared, knockout location.

- b. Thru-the-base capability.

- 1.) Standard unit shall have a thru-the-base electrical location(s) using a raised, embossed portion of the unit basepan.

- 2.) Optional, factory-approved, water-tight connection method must be used for thru-the-base electrical connections.

- 3.) No basepan penetration, other than those authorized by the manufacturer, is permitted.

11. Component Access Panels (standard):

- a. Cabinet panels shall be easily removable for servicing.

- b. Unit shall have one factory installed, tool-less, removable, filter access panel.

- c. Panels covering control box, indoor fan, indoor fan motor, gas components (where applicable), and compressors shall have a molded composite handles.

- d. Handles shall be UV modified, composite, permanently attached, and recessed into the panel.
  - e. Screws on the vertical portion of all removable access panel shall engage into heat resistant, molded composite collars.
  - f. Collars shall be removable and easily replaceable using manufacturer recommended parts.
- H. 23 81 19.13.H. Gas Heat
- 1. General:
    - a. Heat exchanger shall be an induced draft design. Positive pressure heat exchanger designs shall not be allowed.
    - b. Shall incorporate a direct-spark ignition system and redundant main gas valve.
    - c. Gas supply pressure at the inlet to the rooftop unit gas valve must match that required by the manufacturer.
  - 2. The heat exchanger shall be controlled by an integrated gas controller (IGC) microprocessor.
    - a. IGC board shall notify users of fault using an LED (light-emitting diode).
    - b. The LED shall be visible without removing the control box access panel.
    - c. IGC board shall contain algorithms that modify evaporator-fan operation to prevent future cycling on high temperature limit switch.
    - d. Unit shall be equipped with anti-cycle protection with one short cycle on unit flame rollout switch or 4 continuous short cycles on the high temperature limit switch. Fault indication shall be made using an LED.
  - 3. Standard Heat Exchanger construction:
    - a. Heat exchanger shall be of the tubular-section type constructed of a minimum of 20 gage steel coated with a nominal 1.2 mil aluminum-silicone alloy for corrosion resistance.
    - b. Burners shall be of the in-shot type constructed of aluminum-coated steel.
    - c. Burners shall incorporate orifices for rated heat output up to 2000 ft (610 m) elevation. Additional accessory kits may be required for applications above 2000 ft (610 m) elevation, depending on local gas supply conditions.
    - d. Each heat exchanger tube shall contain multiple dimples for increased heating effectiveness.
  - 4. Optional Stainless Steel Heat Exchanger construction:
    - a. Use energy saving, direct-spark ignition system.
    - b. Use a redundant main gas valve.
    - c. Burners shall be of the in-shot type constructed of aluminum-coated steel.
  - d. All gas piping shall enter the unit cabinet at a single location on side of unit (horizontal plane).
  - e. The optional stainless steel heat exchanger shall be of the tubular-section type, constructed of a minimum of 20-gage type 409 stainless steel.
  - f. Type 409 stainless steel shall be used in heat exchanger tubes and vestibule plate.
  - g. Complete stainless steel heat exchanger allows for greater application flexibility.
5. Induced draft combustion motor and blower:
- a. Shall be a direct-drive, single inlet, forward-curved centrifugal type.
  - b. Shall be made from steel with a corrosion-resistant finish.
  - c. Shall have permanently lubricated sealed bearings.
  - d. Shall have inherent thermal overload protection.
  - e. Shall have an automatic reset feature.
- I. 23 81 19.13.I. Coils
- 1. Standard Aluminum Fin/Copper Tube Coils:
    - a. Standard evaporator and condenser coils shall have aluminum lanced plate fins mechanically bonded to seamless internally grooved  $5/16$ -in. diameter copper tubes with all joints brazed.
    - b. Evaporator coils shall be leak tested to 150 psig, pressure tested to 450 psig, and qualified to UL 1995 burst test at 1775 psig.
    - c. Condenser coils shall be leak tested to 150 psig, pressure tested to 650 psig, and qualified to UL 1995 burst test at 1980 psig.
  - 2. Optional Pre-coated aluminum-fin condenser coils:
    - a. Shall have a durable epoxy-phenolic coating to provide protection in mildly corrosive coastal environments.
    - b. Coating shall be applied to the aluminum fin stock prior to the fin stamping process to create an inert barrier between the aluminum fin and copper tube.
    - c. Epoxy-phenolic barrier shall minimize galvanic action between dissimilar metals.
    - d. Corrosion durability of fin stock shall be confirmed through testing to be no less than 1000 hours salt spray per ASTM B117-90.
    - e. Corrosion durability of fin stock shall be confirmed through testing to have no visible corrosion after 48 hour immersion in a room temperature solution of 5% salt, 1% acetic acid.
    - f. Fin stock coating shall pass 2000 hours of the following: one week exposure in the prohesion chamber followed by one week of



accelerated ultraviolet light testing. Prohesion chamber: the solution shall contain 3.5% sodium chloride and 0.35% ammonium sulfate. The exposure cycle is one hour of salt fog application at ambient followed by one hour drying at 95°F (35°C).

3. Optional Copper-fin evaporator and condenser coils:
    - a. Shall be constructed of copper fins mechanically bonded to copper tubes and copper tube sheets.
    - b. Galvanized steel tube sheets shall not be acceptable.
    - c. A polymer strip shall prevent coil assembly from contacting the sheet metal coil pan to minimize potential for galvanic corrosion between coil and pan.
  4. Optional E-coated aluminum-fin evaporator and condenser coils:
    - a. Shall have a flexible epoxy polymer coating uniformly applied to all coil surface areas without material bridging between fins.
    - b. Coating process shall ensure complete coil encapsulation of tubes, fins and headers.
    - c. Color shall be high gloss black with gloss per ASTM D523-89.
    - d. Uniform dry film thickness from 0.8 to 1.2 mil on all surface areas including fin edges.
    - e. Superior hardness characteristics of 2H per ASTM D3363-92A and cross-hatch adhesion of 4B-5B per ASTM D3359-93.
    - f. Impact resistance shall be up to 160 in.-lb (ASTM D2794-93).
    - g. Humidity and water immersion resistance shall be up to minimum 1000 and 250 hours respectively (ASTM D2247-92 and ASTM D870-92).
    - h. Corrosion durability shall be confirmed through testing to be no less than 6000 hours salt spray per ASTM B117-90.
- J. 23 81 19.13.J. Refrigerant Components:
1. Refrigerant circuit shall include the following control, safety, and maintenance features:
    - a. Thermostatic Expansion Valve (TXV) shall help provide optimum performance across the entire operating range. Shall contain removable power element to allow change out of power element and bulb without removing the valve body.
    - b. Refrigerant filter drier - Solid core design.
    - c. Service gage connections on suction and discharge lines.
    - d. Single circuit design with tandem compressor and fully activated evaporator coil.
  2. Compressors:
    - a. Models shall use fully hermetic tandem scroll compressors optimized for comfort staging and IEER energy savings.
    - b. Models shall be available with a single refrigerant circuit and three stages cooling operation on all models.
    - c. Compressor motors shall be cooled by refrigerant gas passing through motor windings.
    - d. Compressors shall be internally protected from high discharge temperature conditions.
    - e. Compressors shall be protected from an over-temperature and over-amperage conditions by an internal, motor overload device.
    - f. Compressor shall be factory mounted on rubber grommets.
    - g. Compressor motors shall have internal line break thermal, current overload and high-pressure differential protection.
    - h. Crankcase heater shall be standard on each compressor and deactivated whenever the compressor is in operation.
- K. 23 81 19.13.K. Filter Section:
1. Filters access is specified in the unit cabinet section of this specification.
  2. Filters shall be held in place by a pivoting filter tray, facilitating easy removal and installation.
  3. Shall consist of factory-installed, low velocity, throw-away 2-in. thick fiberglass filters.
  4. Filters shall be standard, commercially available sizes.
  5. Only one size filter per unit is allowed.
- L. 23 81 19.13.L. Evaporator Fan and Motor:
1. Evaporator Fan Motor:
    - a. Shall have permanently lubricated bearings.
    - b. Shall have inherent automatic-reset thermal overload protection or circuit breaker.
    - c. Shall have a maximum continuous bhp rating for continuous duty operation; no safety factors above that rating shall be required.
    - d. Shall be Variable Frequency duty to match the three-stage compression logic.
    - e. Shall contain motor shaft grounding ring to prevent electrical bearing fluting damage by safely diverting harmful shaft voltages and bearing currents to ground.
  2. Variable Frequency Drive (VFD). For indoor fan motor Staged Air Volume (SAV™) operation:
    - a. Shall be installed inside the unit cabinet, mounted, wired and tested.
    - b. Shall contain Electromagnetic Interference (EMI) frequency protection.
    - c. Insulated Gate Bi-Polar Transistors (IGBT) used to produce the output pulse width

modulated (PWM) waveform, allowing for quiet motor operation.

- d. Self diagnostics with fault and power code LED indicator. Field accessory Display Kit available for further diagnostics and special setup applications.
- e. RS485 capability standard.
- f. Electronic thermal overload protection.
- g. 5% swinging chokes for harmonic reduction and improved power factor.
- h. All printed circuit boards shall be conformal coated.
- i. Shall not contain visual display to adjust internal setting. Only available as field-installed kit.

### 3. Belt-Driven Evaporator Fan:

- a. Belt drive shall include an adjustable-pitch motor pulley.
- b. Shall use sealed, permanently lubricated ball-bearing type.
- c. Blower fan shall be double-inlet type with forward-curved blades.
- d. Shall be constructed from steel with a corrosion resistant finish and dynamically balanced.

## M. 23 81 19.13.M. Condenser Fans and Motors

### 1. Condenser Fan Motors:

- a. Shall be a totally enclosed, multi speed ECM motor.
- b. Shall use permanently lubricated bearings.
- c. Shall have inherent thermal overload protection with an automatic reset feature.
- d. Shall use a shaft-down design on 07 models and shaft-up on 08-12 models with rain shield.

### 2. Condenser Fans:

- a. Shall be a direct-driven propeller type fan.
- b. Shall have galvanized aluminum (galvalum) blades riveted to corrosion-resistant steel spindlers and shall be dynamically balanced.

## N. 23 81 19.13.N. Special Features Options and Accessories

### 1. Low Leak Economizers:

- a. Available as factory-installed option (vertical only) or field-installed accessory (vertical or horizontal) on all electro-mechanical and RTU Open models. SystemVu™ field-installed accessory (vertical or horizontal) also available.
- b. Low leak economizers are available with EconoMi\$er X controls for electro-mechanical units, or EconoMi\$er2 controls for RTU Open or SystemVu units.
- c. Integrated, gear driven opposed blade design type capable of simultaneous economizer and compressor operation.

- d. Damper blades shall be galvanized steel with composite gears. Plastic or composite blades on intake or return shall not be acceptable.
- e. Shall be equipped with gear driven dampers for both the outdoor ventilation air and the return air for positive air stream control.
- f. Standard leak rate models shall be equipped with leakage dampers, not to exceed 2% leakage at 1 in. wg pressure differential.
- g. Shall be capable of introducing up to 100% outdoor air.
- h. Economizer's barometric relief dampers shall be sized to allow up to 100% relief (actual results will be based on specific job conditions).

### 2. Ultra-Low Leak Economizers:

- a. Available as a factory-installed option (vertical only) or field-installed accessory (vertical or horizontal) on all models including: electro-mechanical, RTU Open, and SystemVu.
- b. Ultra-Low Leak economizer dampers meet California's Title 24 section 140.4 prescriptive requirements for leakage, reliability testing, etc., and ASHRAE 90.1-2013 requirements for damper leakage.
- c. Economizers are available with EconoMi\$er X controls for electro-mechanical units, or EconoMi\$er2 controls for RTU Open or SystemVu units.
- d. Integrated, gear driven opposed blade design type capable of simultaneous economizer and compressor operation.
- e. Damper blades shall be galvanized steel with composite gears. Plastic or composite blades on intake or return shall not be acceptable.
- f. Shall be equipped with gear driven dampers for both the outdoor ventilation air and the return air for positive air stream control.
- g. Shall be capable of introducing up to 100% outdoor air.
- h. Economizer's barometric relief dampers shall be sized to allow up to 100% relief (actual results will be based on specific job conditions).

#### 1.) EconoMi\$er® X Economizer Controls:

- a) For use with factory-installed (vertical only) or field-installed accessory (vertical or horizontal) on electro-mechanical units with low leak or ultra-low leak economizers.
- b) Meets California's Title 24 section 120.2 mandatory requirements for economizer Fault Detection and Diagnosis (FDD).

- c) Economizer controller shall be Honeywell W7220 JADE that provides:
    - i. 2-line LCD interface screen for setup, configuration and troubleshooting.
    - ii. On-board FDD detects and alerts when economizer is not operating properly.
    - iii. Sensor failure loss of communication identification.
    - iv. Automatic sensor detection.
    - v. Capabilities for use with multi-speed indoor fan units.
  - d) Compressor lockout temperature on W7220 is adjustable from -45°F (-43°C) to 80°F (27°C), set at a factory default of 32°F (0°C).
  - e) Shall be designed to spring return close outside air damper during loss of power.
  - f) Actuator shall be direct coupled to economizer gear. No linkage arms or control rods shall be acceptable.
  - g) Utilizes digital dry bulb or enthalpy outside air sensors. Factory-installed economizers available with dry bulb or enthalpy. Dry bulb sensors installed on all field-installed economizer accessories.
- 2.) EconoMi\$er2 Economizer Controls:
- a) For use with factory-installed (vertical only) or field-installed accessory (vertical or horizontal) on RTU Open or SystemVu™ units with low leak or ultra-low leak economizers.  
Note: Factory-installed EconoMi\$er2 is available on SystemVu units with ultra-low leak economizers only.
  - b) EconoMi\$er2 economizers are controlled by RTU Open or SystemVu unit controllers, which shall be 4 to 20mA design.
  - c) RTU Open and SystemVu controls meet California's Title 24 section 120.2 mandatory requirements for economizer Fault Detection and Diagnosis.
  - d) Available on factory-installed (vertical only) economizers with dry bulb or enthalpy outside air sensors. Field-installed accessories (vertical or horizontal) are available with dry bulb outside air sensors only.
  - e) Outdoor air sensor setpoint shall be adjustable and shall range from 40°F to 100°F (4°C to 38°C). Additional sensor options shall be available as accessories.
  - f) Shall be designed to spring return close outside air damper during loss of power.
  - g) Actuator shall be direct coupled to economizer gear. No linkage arms or control rods shall be acceptable.
  - h) The economizer controller shall also provide control of an accessory power exhaust unit function. Factory set at 100%, with a range of 0% to 100%.
  - i) The economizer shall maintain minimum airflow into the building during occupied period and provide design ventilation rate for full occupancy.
  - j) Controller shall drive outside air dampers completely closed when the unit is in the unoccupied mode.
  - k) Economizer controller shall accept a 4 to 20mA CO<sub>2</sub> sensor input for IAQ/DCV control. In this mode, dampers shall modulate the outdoor air damper to provide ventilation based on the sensor input.
  - l) Economizer controller shall provide indications when in free cooling mode, in the DCV mode, or the exhaust fan contact is closed.
3. Propane Conversion Kit:
- a. Package shall contain all the necessary hardware and instructions to convert a standard natural gas unit for use with liquefied propane, up to 2000 ft (610 m) elevation.
  - b. Additional accessory kits may be required for applications above 2000 ft (610 m) elevation.
4. Flue Shield (07 model only):
- a. Flue shield shall provide protection from the hot sides of the gas flue hood.
5. Condenser Coil Hail Guard Assembly (Factory or field-installed):
- a. Shall protect against damage from hail.
  - b. Shall be of louvered style.
6. Unit-Mounted, Non-Fused Disconnect Switch:
- a. Switch shall be factory-installed, internally mounted.
  - b. National Electric Code (NEC) and ETL/UL approved non-fused switch shall provide unit power shutdown.
  - c. Shall be accessible from outside the unit.
  - d. Shall provide local shutdown and lockout capability.
  - e. Sized only for the unit as ordered from the factory. Does not accommodate field-installed devices.
7. HACR Breaker:
- a. These manual reset devices provide overload and short circuit protection for the unit. Factory wired and mounted with the units, with

- access cover to help provide environmental protection. On 575V applications, HACR breaker can only be used with WYE power distribution systems. Use on Delta power distribution systems is prohibited.
- b. Sized only for the unit as ordered from the factory. Does not accommodate field-installed devices.
8. Convenience Outlet:
    - a. Powered convenience outlet:
      - 1.) Outlet shall be powered from main line power to the rooftop unit.
      - 2.) Outlet shall be powered from line side or load side of disconnect by installing contractor, as required by code. If outlet is powered from load side of disconnect, unit electrical ratings shall be ETL/UL certified and rated for additional outlet amperage.
      - 3.) Outlet shall be factory-installed and internally mounted with easily accessible 115-v female receptacle.
      - 4.) Outlet shall include 15 amp GFI receptacles with independent fuse protection.
      - 5.) Voltage required to operate convenience outlet shall be provided by a factory-installed step-down transformer.
      - 6.) Outlet shall be accessible from outside the unit.
      - 7.) Outlet shall include a field-installed "Wet in Use" cover.
    - b. Non-powered convenience outlet:
      - 1.) Outlet shall be powered from a separate 115/120v power source.
      - 2.) A transformer shall not be included.
      - 3.) Outlet shall be factory-installed and internally mounted with easily accessible 115-v female receptacle.
      - 4.) Outlet shall include 15 amp GFI receptacles with independent fuse protection.
      - 5.) Outlet shall be accessible from outside the unit.
      - 6.) Outlet shall include a field-installed "Wet in Use" cover.
  9. Flue Discharge Deflector (07-12 models only):
    - a. Flue discharge deflector shall direct unit exhaust vertically instead of horizontally.
    - b. Deflector shall be defined as a "natural draft" device by the National Fuel and Gas (NFG) code.
  10. Thru-the-Base Connectors (07 models only):
    - a. Kit shall provide connectors to permit thru-the-bottom electrical connections to be brought to the unit through the unit basepan and thru-the-curb gas connection.
    - b. Maximum of four connection locations per unit.
  11. Propeller Power Exhaust:
    - a. Power exhaust shall be used in conjunction with an integrated economizer.
    - b. Independent modules for vertical or horizontal return configurations shall be available.
    - c. Horizontal power exhaust is shall be mounted in return ductwork.
    - d. Power exhaust shall be controlled by economizer controller operation. Exhaust fans shall be energized when dampers open past the 0 to 100% adjustable setpoint on the economizer control.
  12. Roof Curbs (Vertical):
    - a. Full perimeter roof curb with exhaust capability providing separate air streams for energy recovery from the exhaust air without supply air contamination.
    - b. Formed galvanized steel with wood nailer strip and shall be capable of supporting entire unit weight.
    - c. Permits installation and securing of ductwork to curb prior to mounting unit on the curb.
  13. High-Static Indoor Fan Motor(s) and Drive(s):
    - a. High-static motor(s) and drive(s) shall be factory-installed to provide additional performance range.
  14. High Altitude Gas Conversion Kit:
    - a. Package shall contain all the necessary hardware and instructions to convert a standard natural gas unit to operate from 2000 to 7000 ft (610 to 2134 m) elevation with natural gas or from 0 to 7000 ft (90-2134 m) elevation with liquefied propane.
  15. Thru-the-Bottom Utility Connectors:
    - a. Kit shall provide connectors to permit electrical and gas connections to be brought to the unit through the basepan.
  16. Outdoor Air Enthalpy Sensor:
    - a. The outdoor air enthalpy sensor shall be used to provide single enthalpy control. When used in conjunction with a return air enthalpy sensor, the unit will provide differential enthalpy control. The sensor allows the unit to determine if outside air is suitable for free cooling.
  17. Return Air Enthalpy Sensor:
    - a. The return air enthalpy sensor shall be used in conjunction with an outdoor air enthalpy sensor to provide differential enthalpy control.
  18. Indoor Air Quality (CO<sub>2</sub>) Sensor:
    - a. Shall be able to provide demand ventilation indoor air quality (IAQ) control.
    - b. The IAQ sensor shall be available in duct mount, wall mount, or wall mount with LED display. The setpoint shall have adjustment capability.

19. Smoke Detectors (factory-installed only):
  - a. Shall be a four-wire controller and detector.
  - b. Shall be environmental compensated with differential sensing for reliable, stable, and drift-free sensitivity.
  - c. Shall use magnet-activated test/reset sensor switches.
  - d. Shall have tool-less connection terminal access.
  - e. Shall have a recessed momentary switch for testing and resetting the detector.
  - f. Controller shall include:
    - 1.) One set of normally open alarm initiation contacts for connection to an initiating device circuit on a fire alarm control panel.
    - 2.) Two Form-C auxiliary alarm relays for interface with rooftop unit or other equipment.
    - 3.) One Form-C supervision (trouble) relay to control the operation of the Trouble LED on a remote test/reset station.
    - 4.) Capable of direct connection to two individual detector modules.
    - 5.) Can be wired to up to 14 other duct smoke detectors for multiple fan shut-down applications.
20. Horn/Strobe Annunciator:
  - a. Provides an audible/visual signaling device for use with factory-installed option or field-installed accessory smoke detectors.
    - 1.) Requires installation of a field-supplied 24-v transformer suitable for 4.2 VA (AC) or 3.0 VA (DC) per horn/strobe accessory.
    - 2.) Requires field-supplied electrical box, North American 1-gang box, 2-in. (51 mm) x 4-in. (102 mm).
    - 3.) Shall have a clear colored lens.
21. Time Guard:
  - a. Shall prevent compressor short cycling by providing a 5 minute delay ( $\pm$  2 minutes) before restarting a compressor after shut-down for any reason.
  - b. One device shall be required per compressor.
22. Hinged Access Panels:
  - a. Shall provide easy access through integrated quarter turn latches.
  - b. Shall be on major panels of: filter, control box, fan motor and compressor.
23. Display Kit for Variable Frequency Drive:
  - a. Kit allows the ability to access the VFD controller programs to provide special setup capabilities and diagnostics.
    - b. Kit contains display module and communication cable.
    - c. Display Kit can be permanently installed in the unit or used on any SAV™ system VFD controller as needed.
24. Supply Duct Kit:
  - a. On 08-12 models, a supply air duct cover kit is required when field converting the factory standard vertical duct supply to horizontal duct supply configuration. One required per unit.
25. Thermostat:
  - a. Due to the three-stage cooling capacity design of these units, a three-stage cooling thermostat is required for the unit to perform at listed operating efficiencies.
  - b. Carrier offers a Honeywell branded T7350D (3 Cool/3 Heat) Commercial Programmable Thermostat. This provides:
    - 1.) 7-day programmable 365-day clock with holiday programming
    - 2.) Automatic Daylight Saving Time adjustment
    - 3.) Backlit display
    - 4.) Changeover selections: automatic or manual
    - 5.) Fan configurable: continuous or intermittent during occupied
26. Humidi-MiZer® Adaptive Dehumidification System:
  - a. The Humidi-MiZer Adaptive Dehumidification System shall be factory installed, certified and tested to provide greater dehumidification of the occupied space by providing two distinct modes of dehumidification operation in addition to its normal design cooling mode:
    - 1.) Subcooling mode further sub cools the hot liquid refrigerant leaving the condenser coil as well as reheat leaving air stream. It can provide both better cooling capacity as well as dehumidification process when both temperature and humidity in the space are not satisfied.
    - 2.) Hot gas reheat mode shall mix a portion of the hot gas from the discharge of compressor with the hot liquid refrigerant leaving the condenser coil to create a two-phase warm refrigerant in the reheat coil which results in a neutral leaving air temperature when only humidity in the space is not satisfied.





