



 **magicwand**<sup>®</sup>  
**MINI**

# Instructions & User Manual

Personal Massager  
Model HV-135

For more information, please visit [www.MagicWandOriginal.com](http://www.MagicWandOriginal.com)



Distributed by Vibratex, Inc.

1.888.558.9778

[contact@MagicWandOriginal.com](mailto:contact@MagicWandOriginal.com)



## CONTENTS

 <b>IMPORTANT SAFETY INSTRUCTION</b> .....	2
■ Identifying Key Parts.....	7
■ Charging the Magic Wand.....	8
■ Operating the Magic Wand.....	9
■ Care and Cleaning.....	10
■ Storing the Magic Wand.....	11
■ Specifications.....	11
 <b>Trouble Shooting</b> .....	12
■ Battery Recycling Information.....	13
■ Warranty.....	15

## ! IMPORTANT INFORMATION





- Please read and follow the “IMPORTANT SAFETY INSTRUCTIONS” below before using this product.
- After reading, please save or keep this manual in safe location and review it when necessary
- This product is for household use only and is not intended to address or treat any medical condition. Please do not use it for any other purpose. Improper usage may cause serious accidents.
- Please charge this product before first use.

## ! IMPORTANT SAFETY INSTRUCTIONS

### Signal Word Definitions and Meanings

- The definitions of the signal words used in this manual are separated into 4 levels according to the degree of danger (or level risk) as outlined below.

<Signal Word>	<Meaning>
 <b>DANGER</b>	Indicates a hazardous situation which, if not avoided, will result in death or serious injury.
 <b>WARNING</b>	Indicates a hazardous situation which, if not avoided could result in death or serious injury.
 <b>CAUTION</b>	Indicates a hazardous situation which, if not avoided could result in minor or moderate injury.
<b>NOTICE</b>	Other consideration

- When using an electrical appliance, basic precautions should always be followed, including the following:  
Read all instructions before using this appliance.

## Warranty

The Magic Wand is backed by a one-year limited warranty. If you have questions concerning the Magic Wand, or if your massager isn't functioning properly, please email: [contact@MagicWandOriginal.com](mailto:contact@MagicWandOriginal.com). Do not attempt to repair the Magic Wand yourself.

### LIMITED WARRANTY

This item is warranted to be free from defects in materials or workmanship for a period of one year from the original date of purchase under normal conditions of intended use. If this product is defective, Warrantor will, within the warranty period, replace the product or refund the purchase price of the product, at Warrantor's option. This warranty extends only to the original retail purchaser and excludes any damage to the product resulting from accident, misuse, abuse, damage caused by electrical power surge, or operation not recommended or authorized by these operating and safety instructions. This warranty is voided if the product is ever used in a commercial or business environment.

There are no warranties beyond this limited warranty. This limited warranty is your complete and exclusive remedy. Warrantor makes no other warranties, express or implied, including but not limited to any implied warranty of merchantability or of fitness for a particular purpose. Warrantor undertakes no responsibility for the quality of the product except as otherwise provided herein. Warrantor assumes no responsibility that the product will be fit for any particular purpose for which you may be buying this product. Warrantor expressly disclaims liability for any special, incidental, indirect, or consequential damages arising from the purchase or use of this product.

The amount of Warrantor's liability under this warranty is limited to the amount of the original purchase price paid for the product by the original retail purchaser. If Warrantor cannot lawfully disclaim statutory or implied warranties, then all such warranties shall be limited to the duration of this warranty and to the amount of the original purchase price paid for the product by the original retail purchaser.

This warranty gives you specific legal rights; you may also have other rights that vary by jurisdiction. This warranty is valid only within the United States of America (USA).

### WARRANTY CLAIM PROCEDURE

If you believe you have a warranty issue, or if your massager isn't functioning properly, please follow these steps:

1. Visit <http://magicwandoriginal.com/warranty>
2. Prepare to submit your claim by gathering images of your product and original proof of purchase.
3. Carefully follow instructions to complete the online claim form.
4. Following your submission, the warranty team will contact you to request additional information or provide disposition and next steps.

Distributed by Vibratex, Inc.  
Phone: 1.888.558.9778  
Email: [contact@MagicWandOriginal.com](mailto:contact@MagicWandOriginal.com)



## Charging the Magic Wand

Charge the product before first use. Use only the included charging adapter, connected to a standard 100-240V AC electrical outlet.

- Step 1. Ensure the product is turned off (the product is not vibrating, no blue indicator lights are illuminated).
- Step 2. Insert the charging adapter into the charging port of the product (See drawing below).

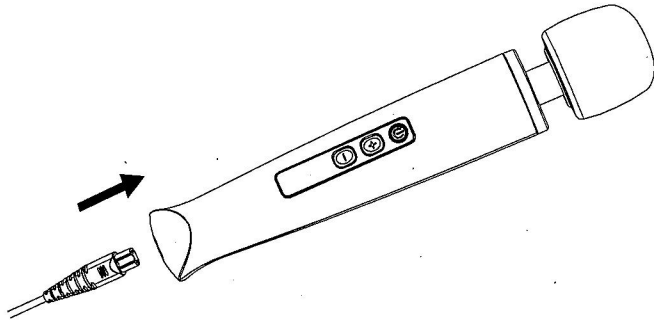

- Step 3. Plug the charging adapter into outlet. Verify that the charging indicator lights up (red) to indicate charging.
- Step 4. The charging indicator light will switch to green when the product is fully charged. Approximate charging time is 4 hours.
- Step 5. After charging, be sure to pull out the charging adapter from the product. Then, remove the charging adapter from the outlet.

- The low battery indicator will flash red when the battery needs to be charged.

 <b>WARNING</b>	<ol style="list-style-type: none"> <li>1. Use only the charging adapter included with the product.</li> <li>2. The charging adapter will heat up while charging the massager.</li> <li>3. Never charge the product on a thick-piled carpet etc.</li> <li>4. Pay attention to the charging adapter unit and the product while charging.</li> <li>5. Regarding other warnings, please see WARNINGS for charging on page 5 of this instruction manual.</li> </ol>
--------------------	--

<b>NOTICE</b>	<p>This product uses a lithium-ion battery. In order to deliver full performance, observe the following:</p> <ol style="list-style-type: none"> <li>1. Do not leave the massager plugged in for more than four hours. And charge only when the remaining battery level indicator lamp flashes "RED". Failure to follow this advice will reduce the life of the battery.</li> <li>2. This battery will perform the best if charging takes place in temperatures from 10-35°C(50-95°F).</li> <li>3. Store in a dry, cool place. Avoid storing the product in temperatures of 40°C(104°F) or above, or temperatures of 0°C(32°F) or below.</li> </ol>
---------------	--

## Operating the Magic Wand

The product cannot be used while it is connected to the adapter and cord. The adapter only for charging the product.

- Step 1. Press the ON/OFF button to turn the massager on.

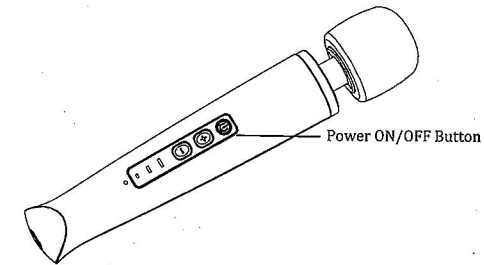

- Step 2. To control the intensity/vibration level press the (+) button to increase the level accordingly.

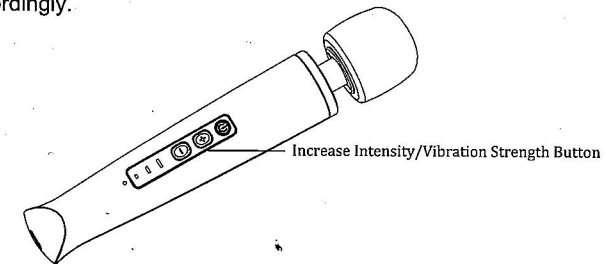

- Step 3. To control the intensity/vibration level press the (-) button to decrease the level accordingly.

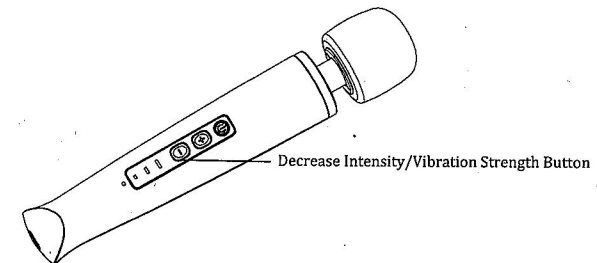



- There are 3 intensity/vibration levels. To adjust the intensity/vibration level, press the appropriate (+) or (-) button for desired setting. The blue intensity indicator lights will light up to show what intensity/vibration level you are using.

Intensity/Vibration Level Indicator Lights(Blue)	Level
-	1
=	2
≡	3

Step 4. Gently apply to desired body part for targeted relief.

Step 5. Turn off the product.

- Press the ON/OFF button to turn the massager off.
- The product will automatically shut off after approx. 20 Minutes to protect it from overheating.



 <b>WARNING</b>	<ol style="list-style-type: none"> <li>1. Make sure to observe the following causes of fire, electric shock and injury etc.: <ul style="list-style-type: none"> <li>• Do not use the product on head, face, chest, stomach and osseous part (elbow and knee etc.)</li> <li>• Regarding other warnings, please see WARNINGS on page 3-5 of this manual</li> </ul> </li> </ol>
 <b>CAUTION</b>	<ol style="list-style-type: none"> <li>1. Do not use creams, butters, oils, lotions or silicone-based lubricants on the product. →Cause of skin inflammation and damage to the product.</li> <li>2. <b>Use for no more than 20 minutes at a time. Do not massage one area for more 3 minutes. The massager will turn off after 20 minutes, or sooner, if it becomes warm.</b></li> </ol>

NOTICE	<ol style="list-style-type: none"> <li>1. It is recommended that the product be used in temperatures from 0-35°C. (32-95°F) Outside of that range the product may not work properly, or the usage time may be reduced.</li> <li>2. If the battery level indicator lamp starts flashing "red", connect the charger.</li> </ol>
--------	---

### Care and Cleaning

Ensure the product is turned off before cleaning (the product is not vibrating, no blue light is illuminated).

Wipe the product clean carefully before and after each use.

 <b>WARNING</b>	<ol style="list-style-type: none"> <li>1. Do not wash the massager with water. Do not let any water or other liquid enter into the product. →Cause of battery bursting and ignition of product.</li> <li>2. Be sure to pull out the charging adaptor from this product and from the outlet during cleaning. →Cause of electric shock and short-circuit.</li> </ol>
 <b>CAUTION</b>	<ol style="list-style-type: none"> <li>1. Do not use abrasive cleaners or pads on the product.</li> <li>2. Do not clean the product with alcohol, benzene, acetone or any liquid chemical cleanser. →Cause of damage or discoloration.</li> <li>3. Regularly clean the charging plug with dry cloth. →Cause of accident.</li> </ol>

### Identifying Key Parts

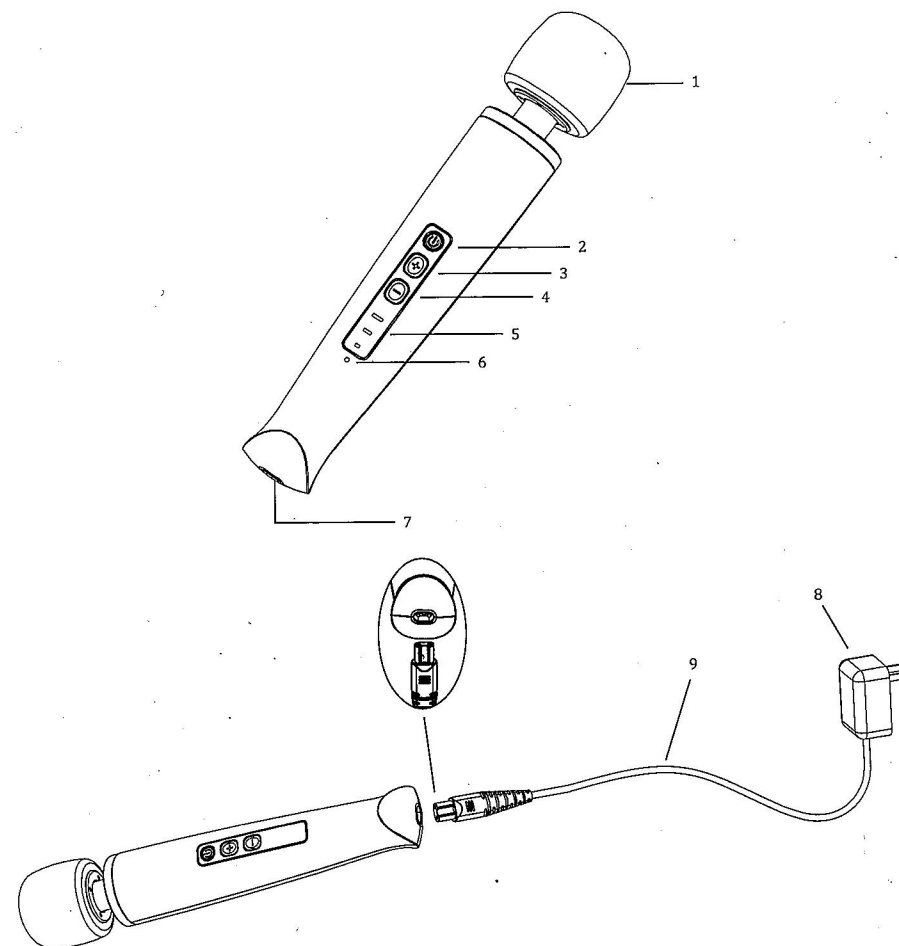

1. Vibrating Head
2. Power ON/OFF Button
3. Increase Intensity/Vibration Strength Button
4. Decrease Intensity/Vibration Strength Button
5. Intensity/Vibration Indicator Lights (Blue)
6. Charging Indicator Light – Charging Indicator (red) / Low Battery Indicator (flashing red) / Charging Complete Indicator (green)
7. Charging Port
8. Charging Adaptor
9. Charging Cord



# ⚠ IMPORTANT SAFETY INSTRUCTIONS

## ⚠ CAUTION

1. Use for no more than 20 minutes at a time. Do not massage one area for more than 3 continuous minutes. This may cause adverse results or injury. After 20 minutes, turn the massager off and allow it to cool before turning it on again.
2. Do not use the product on your chest and or around your thyroid gland (just below the Adam's apple).
3. If you feel pain or experience any adverse reaction during or after use of this product, immediately stop using the product and consult a doctor. Failure to do so may result in injury.
4. Don't grasp the vibrating head while your massager is turned ON.
5. Don't use your massager over swollen or inflamed areas, or skin eruptions.
6. Don't use on an unexplained calf pain. Whenever in doubt, consult your physician.
7. Be sure to turn the product off after use.
8. Keep long hair away from this product while in use. Risk of injury or damage.
9. Do not use this product in close proximity to loose clothing or jewelry.
10. Do not use if any of these conditions apply:
  - Very tired
  - Under the influence of alcohol
  - Suffering from eczema
11. Do not use for an hour before or after eating.
12. Never use force to bend or twist the head of the product. Pushing the harder head to your body does not produce a stronger massage and may cause damage or injury.
13. Never use this product together with, or at the same time as, another massager. May cause injury.
14. Be careful never to fall asleep with the product turned on. May cause injury.
15. Do not use creams, butters, oils, lotions or silicone-based lubricants on the product. May degrade the silicone head.
16. It is recommended that the product be used in temperatures from 0-35°C (32°-95° F) outside of this range the product may not operate properly.
17. Do not use abrasive cleaners or pads on the product.
18. Do not use alcohol, benzene, acetone or any liquid chemical cleanser on any part of the product.
19. In case of a power outage, be sure to remove the charging plug from the outlet.
20. To disconnect, ensure the product is in the off position and then remove the charging plug from the outlet by grasping the charging adaptor, never by pulling or the charging cord.
21. After use, store the product in a place out of reach of children.

**SAVE THESE INSTRUCTIONS**

## Storing the Magic Wand

Store the product in a cool, dry place.

1. After cleaning, store the product in a place free from excessive humidity or dirt.
2. If you do not use the product for a while, cover it to protect it from dust.
3. Never place the product within reach of children.
4. Do not drop the product and protect it from impact.
5. Do not store in a place of humidity and high temperature and direct sunlight.
6. Do not store the product at temperatures below 0°C(32°F).
7. Be sure to turn off the product and unplug the charging adaptor from outlet before storing the product.
8. Do not wind the charging cord around the charging adaptor or the main body.
9. Do not twist the charging cord.

## Specifications

Specifications are subject to change without prior notice.

Power supply	Main body	Rechargeable Battery (Lithium-ion battery 3.6V 2100mAh)
	Charging adaptor	Input :AC100-240V 50-60Hz Output: 5V 1A
Battery charging time	Approx. 4 hours for full charge	
Battery charge duration	Approx. 2.5 hours	
Weight	Main body : Approx. 275g Charging adaptor : Approx. 80g	
Dimension	Approx. 9.6" x 1.9"	
Material	Main body : ABS plastic Head : Silicone	
Charging adapter cord length	Approx. 6 feet (1.8 m)	
Head vibration level	Level 1 - Approx. 3,500 vibrations per minute Level 2 - Approx. 5,000 vibrations per minute Level 3 - Approx. 6,000 vibrations per minute	
Operating temperature	Approx. 0°C ~35°C(32~95°F)	

### NOTICE

Under certain circumstances, such as high altitude or low temperatures, the product may not achieve optimal performance.

## ⚠️ Trouble Shooting

If you experience any problem with the massager, stop using it immediately and turn it off. Consult the troubleshooting guide below. If the problem is not resolved, contact the distributor.

Problems	Possible causes	Elimination
No movement with the switch "ON"	The battery may be low.	Turn the product "OFF", then charge for approx. 4 hours before use.
The charging light does not illuminate	1. Check to see if the charging adapter is properly connected to the outlet. 2. Check to see if the charging plug is properly connected.	1. Insert the charging adapter into outlet. 2. Ensure the charging adapter is properly connected to the product.
Usage time seems short	1. The battery may be low. 2. The product may have been charged in temperatures that were too low or too high.	1. Charge the product in a place where the temperature is within approx. 10-35°C(50-95°F). 2. If the usage time seems short even after the product is fully charged, there may be a problem with the product, or the battery may be nearing the end of its usable life.
The product shuts off during usage	The product will automatically shut off after approx. 20 Minutes.	
The motor makes a sound	If a sound can be heard while the product is running, this is normal. It is the sound of the moving motor.	



**WARNING**

1. If you believe there is a problem with your massager, if it is damaged or deformed, stop using it immediately and turn it off. Contact the distributor.
2. If after consulting the troubleshooting guide the massager still doesn't function properly, contact the distributor for assistance, on: [contact@MagicWandOriginal.com](mailto:contact@MagicWandOriginal.com)
3. Do not attempt to modify or replace the rechargeable lithium-ion battery. This may cause fire or electric shock.
4. Never attempt to modify this product in any way.

## ⚠️ IMPORTANT SAFETY INSTRUCTIONS

### ⚠️ WARNING

**Before using this product, please note:**

25. **Never use or leave in a place where water is splashed such as a bathroom, nor in a place with high humidity. This may cause short circuit.**
26. **Never connect or disconnect the charging adapter to/from the outlet with wet hands. This may cause short circuit and electric shock.**
27. **To disconnect, ensure the product is in the off position and then remove the charging plug from the outlet.**
28. **Keep long hair away from this product while in use.**
29. **Do not use this product in close proximity to loose clothing or jewelry.**

**Before using this product, please read this:**

**Failure to observe these instructions could result in electric shock, fire or short circuit of the product.**

1. **Never allow the charging port to short circuit by contact with metals.**
2. **Never use a charging cord or a charging adapter if they are damaged or if the charging plug doesn't appear to fit snugly in the outlet.**
3. **Never damage the charging cord; do not unnecessarily bend, pull, twist, bind, place a heavy object on it, pinch, or wind around the charging adapter, etc.**
4. **Use only the charging adapter included with this product.**
5. **Never use the included charging adapter with other products.**
6. **Do not pull out the charging adapter, by the charging cord.**
7. **Regularly remove dust from the charging adapter using a dry cloth.**
8. **If any problem occurs, stop using this product immediately, turn it off and remove the charging adapter from the outlet.**
9. **Never remove the lithium-ion battery except for disposal(recycling).**
10. **Never modify the lithium-ion battery for replacing.**
  - At the end of battery life cycle, stop using this product. Replacing the battery may cause fire or electric shock.
11. **If the battery is removed for disposal (recycling), please pay attention to the following:**
  - Do not use in another product.
  - Do not charge the removed battery.
  - Do not throw in fire or overheat it.
  - Do not puncture with a nail, give a shock, disassemble, or modify it.
  - Do not bring (+) and (-) into contact with metal, ect.
  - Do not carry or store it together with a necklace, hairpin, etc.
  - Do not leave it in a hot place, such as near a fire or in direct sunlight.
  - Do not peel off the tube from battery.
12. **Never leave a battery within reach of children.**
  - Swallowing the liquid leakage etc. may cause injury or great bodily harm. Seek immediate medical attention if ingestion is suspected.
13. **If the battery leaks, do not touch it with bare hands but take the following action:**
  - If the fluid gets in eye, this can cause blindness.
  - Do not rub eyes, but immediately rinse with clean water and then seek medical attention.
  - If the fluid adheres to the body or clothing, this can cause skin inflammation and injury.
  - Rinse thoroughly with clean water and then seek medical attention.
  - Never put a leaking battery close to fire.
  - The leaking electrolyte may catch fire and cause battery bursting and ignition.

## ⚠ IMPORTANT SAFETY INSTRUCTIONS

### ⚠ WARNING

Before using this product, please note:

1. The product should never be left unattended when plugged in, Unplug from outlet when not in use.
2. Close supervision is necessary when this appliance is used by, on, or near children or individuals needing additional assistance.
3. Use this product only for its intended use as described in this manual. Do not remove cover: there are no serviceable parts inside. Doing so may cause injury and/or electric shock.
4. Do not use attachments not recommended by manufacturer.
5. Never use this product on head, face, chest, stomach and osseous part (i.e. elbow, knee etc.). This may cause injury.
6. Do not use excessive force when applying to the body. This may cause damage to skin and muscle.
7. Never place in or near fire or overheat this product. This may cause the battery to burst or catch fire.
8. Never use this product near a source of heat, such as heater. Never use while smoking. This may cause a fire.
9. Do not use this product under a blanket or pillow. This may create excessive heat and may cause fire, electric shock, or injury.
10. Never drop this product or subject it to impact. This may cause a short circuit, electric shock, or other damage.
11. Do not sit or lie on this product. Do not place a heavy item on top of this product. This may damage the product and/or cause injury.
12. Use only 100-240V AC for power supply. Use of other power supplies creates risk of damage or electric shock.
13. Never modify or repair this product. This may cause battery leakage and fire. Contact the distributor for assistance with warranty.
14. Never operate this product if it has a damaged cord or plug, if it is not working properly, if it has been dropped or damaged, or dropped into water, discontinue use and contact the distributor.
15. Keep the cord away from heated surfaces.
16. Do not carry this product by charging cord or use cord as a handle. This may cause damage.
17. Never operate this product with the air openings blocked. Keep the air openings free of lint, hair, etc...
18. Never drop or insert any object into any opening.
19. Do not operate where aerosol (spray) products are being used or where oxygen is being administered.
20. Never operate on a soft surface such as a bed or couch where the air openings may become blocked.
21. Do not touch the silicone vibrating head with sharp objects.
22. Do not use outdoors. Do not get product wet. This may cause damage and electric shock.
23. Absolutely never clean this product with water. This may cause short circuit and electric shock.
24. Never allow liquid to collect on or near the charging adapter and charging port. This may cause the battery to burst or catch fire.

## Battery Recycling Information

The Magic Wand is powered by one rechargeable lithium-ion battery, which are recyclable. If you wish to dispose of your Magic Wand, you can help preserve our environment by returning your used rechargeable battery to the collection and recycling location nearest to you. For more information, please call 1-800-822-8837, or visit [www.call2recycle.org](http://www.call2recycle.org).

Rechargeable batteries have a certain lifespan. If the Magic Wand will no longer hold a charge, the batteries may be near the end of their useful life. If this happens, stop using the Magic Wand. Before discarding the massager, please remove the batteries and recycle them, as described below.

Note: The batteries are not replaceable

### <How to remove the lithium-ion battery > (See illustration below.)

- Step 1. Keep the switch "ON" until the product stops moving completely to discharge the lithium-ion battery.
- Step 2. Insert a sharp object (such as an awl or a paper clip) into the gap of the screw cap and pry open the screw cap.

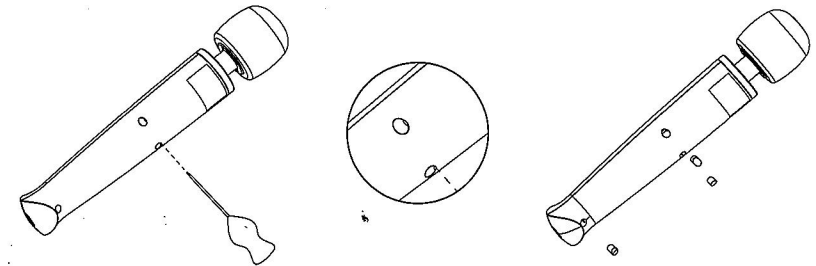

- Step 3. Loosen and remove the five screws as below.

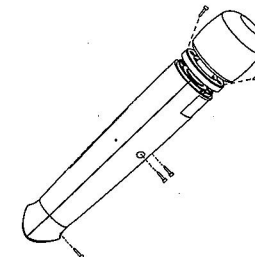

- Step 4. Remove the cover and pull out the battery connector.

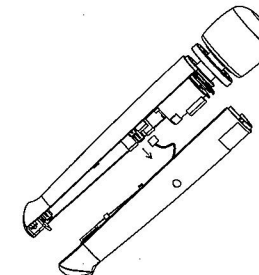

- Step 5. Loosen and remove the four screws on the battery box. Remove the battery.





## WARNING

1. Never remove the battery except to dispose of it (to recycle it).  
→Cause of accident, fire and electric shock.
2. Never modify the lithium-ion battery and / or attempt to replace it.  
→At the end of battery life cycle, stop using this product.  
Replacing the battery causes fire or electric shock.
3. Never place the removed screws within reach of an infant.  
→Cause of accidental ingestion by infant.

Please note when removing the battery for recycling.

1. Never place the product within reach of children.  
→In case you suspect the battery may have been swallowed, seek immediate medical attention.
2. If the battery leaks, do not touch it with bare hands but take the following action:
  - If the fluid gets in the eye, this causes the blindness.  
→Do not rub eyes but immediately rinse with clean water and then seek medical attention.
  - If the fluid adheres to the body or clothing, this causes skin inflammation and injury.  
→Rinse liberally with clean water and then seek medical attention.
  - Never put the leaking battery close to fire.
  - The leaking electrolyte may catch fire and may cause the battery to burst or ignite.
3. Please pay attention to the following causes of fire, electric shock and injury:
  - Do not throw in fire or overheat it.
  - Do not puncture with a nail, expose to impact, disassemble, or modify it.
  - Do not charge battery.
  - Do not bring (+) and (-) into contact with metal, etc.
  - Do not carry or store it together with a necklace, hairpin, etc.
  - Do not leave it in a hot place, such as near a fire or in direct sunlight.
  - Do not peel the tube from the battery.

## ⚠ IMPORTANT SAFETY INSTRUCTIONS

### ⚠ DANGER

To reduce the risk of electric shocks, burns, fire or injury:

1. Be extremely careful never to expose the product to any liquid, including body fluids water, lubricants or cleaners. Serious injury may occur if fluid enters into the product. This product is NOT waterproof.
2. For external use only. Do not insert into any body cavity.
3. Always unplug this product from the outlet immediately after using and before cleaning.
4. Do not use while bathing or in the shower.
5. Do not place or store massager where it can fall or be pulled into a tub or sink.
6. Do not place in or drop into water or other liquid.
7. Do not reach for massager that has fallen into water. Unplug it immediately.
8. Do not use on any wet body part; do not use in the rain.
9. Do not wash the massager with water or boiling liquids.
10. Do not modify or dismantle the lithium-ion battery.
11. Never operate the massager if it has a damaged charging cord or charging plug, if it is not working properly, if it has been dropped or damaged, or dropped into water. Immediately contact the distributor to request information about warranty replacement – [www.magicwandoriginal.com/warranty](http://www.magicwandoriginal.com/warranty)

### ⚠ WARNING

To reduce the risk of burns, fire, electric shock, or injury to persons. Before using this product, consider if it is safe for you:

1. The following persons should consult a doctor before use.
  - Persons with self-contained medical electric devices such as pacemaker.
  - Persons with malignancy.
  - Persons who have heart conditions.
  - Women who are/or may be pregnant or have recently given birth.
  - Persons who are perpetually disabled by advanced peripheral circulatory disturbance caused by, for instance, diabetes.
  - Persons who have skin wounds or who have extreme skin sensitivity.
  - Persons who require bed rest.
  - Persons who have a body temperature higher than 38°C(100.4°F), suffering from acute inflammation, malaise, chill and/or blood pressure change.
  - Persons who have osteoporosis or acute pain, e.g., from spine fracture, sprain and / or muscle strain.
  - Persons who have a hernia of intervertebral disk.
  - Persons who have deformed spine.
  - Persons who are undergoing medical treatment.
2. Persons who have been told by a doctor to avoid massage should not use this product.  
(Example: thrombosis, massive aneurism, acute varietal hemorrhage, various dermatitis and infection of skin including subcutis inflammation etc.)
3. Persons who are unable to operate this product by themselves should not use this product.
4. For adult use only. Keep this product out of reach of children.