

INSTRUCTION MANUAL



TORNADO

24" PRO METAL OSCILLATING WALL FAN

Model: HI-FAN-24MOWF- A-1P

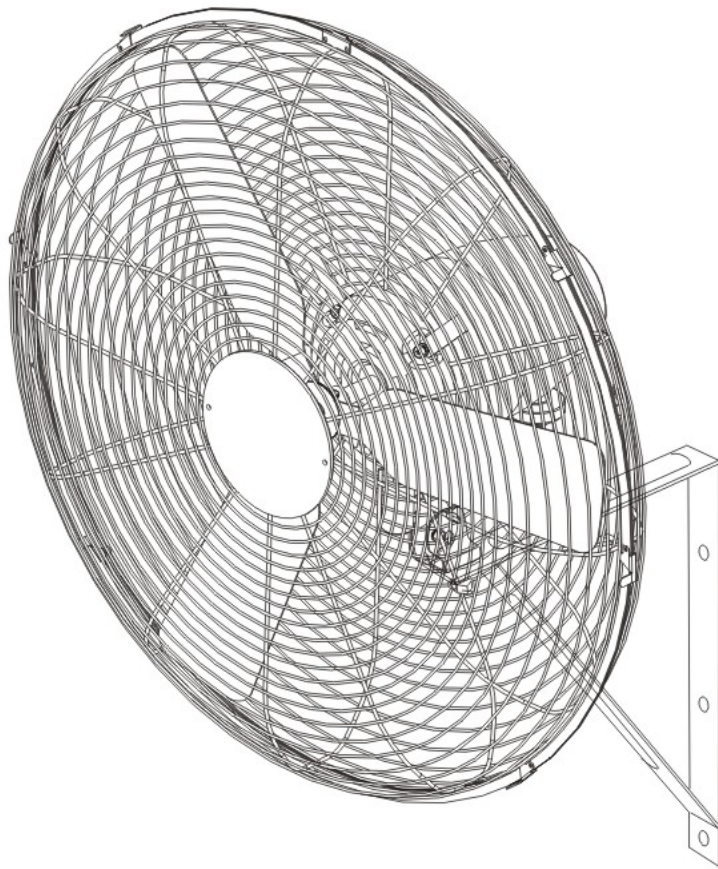

PLEASE READ AND SAVE THIS INSTRUCTION.

Attention: Pictures in the IM are for reference only.

Intended Use:

This product is intended for **industrial or commercial** use only. Use only with electrical wiring that is in good working order and that meets applicable codes and ordinances. If you have any questions whether your wiring is adequate, consult a qualified electrician.

While using your fan, you should follow the IMPORTANT INSTRUCTIONS listed below. As part of those instructions, we have used the word "WARNING" to indicate the level of hazard: WARNING indicates a hazard which, if not avoided, could result in injury or death.

IMPORTANT INSTRUCTIONS

As with all electrical appliances, basic safety precautions should always be followed to reduce the risk of electric shock, fire, or injury to persons, including the following precautions:

- Read all the instructions before using this fan.
- Use this fan only as described in this manual. Any other use not recommended by the manufacturer may cause electrical shock, fire or injury to persons.
- Do not operate the fan with a damaged power cord or after the fan malfunctions or has been dropped in any manner.
- Use of extreme caution is necessary when any fan is used by or near children, disabled persons or pets and whenever the fan is left operating unattended.
- Do not place the fan on a small, unlevel, uneven or any surface which might allow fan to tip or fall.
- Always unplug fan when not in use, when moving from place to place, when assembling or disassembling parts, and before cleaning.
- The use of attachments, not recommended or sold by the manufacturer, may cause hazards.
- Do not use outdoors.
- To reduce the risk of fire or electrical shock, do not expose to water or rain.
- To reduce the risk of fire or electrical shock, do not use this fan with any solid state speed control device.
- Do not operate the fan with blade guards or any safety device removed.
- Automatically operated device - To reduce the risk of injury, disconnect from power supply before servicing.
- If the power supply cord is damaged, contact your local service center or a qualified electrician to install an appropriate replacement cord to prevent any injury or damage.
- To reduce the risk of injury to persons, install fan at least 2.1m (7 feet) above the floor.
- Avoid the use of extension cords due to risk of fire. If an extension cord must be used, the cord must be minimum 14 AWG and rated not less than 1875 watts.
- Do not run power cord under carpeting. Do not cover cord with throw rugs, runners or the like. Arrange cord away from traffic area where it will not be tripped over.
- Do not insert or allow any object to enter any openings on the fan. Doing so may cause electric shock and/or fire hazard. Avoid contact with moving parts.
- This appliance is not intended for use by persons (including children) with reduced physical, sensory or mental capabilities or lack of experience and knowledge, unless they have been given supervision or instruction concerning use of the appliance by a person responsible for their safety.
- Children should be supervised to ensure they do not play with the appliance.

READ & SAVE THESE INSTRUCTIONS

⚠ WARNING: Shock Hazard

Use your fan only in dry environments. This fan is not intended for use in a bathroom, laundry area, or similar locations, or near sinks, washing machines, swimming pools or other sources of water. Never locate fan where it may fall into a bathtub or other water receptacle. Do not use in damp environments such as flooded basements.

⚠ WARNING: Hot Surfaces

Do not touch fan motor when in use. This motor is hot when in use, to avoid burns, do not let bare skin touch hot surfaces.

⚠ WARNING: Fire Hazard

Fans have arcing or sparking parts inside. Do not use near combustible materials or flammable gases or sources of heat. DO NOT USE in areas where gasoline, paint or flammable materials are used or stored. To prevent a possible fire, do not block air intakes or exhaust in any manner. Do not insert or allow foreign objects to enter any ventilation or exhaust opening as this may cause an electric shock, fire, or damage the fan.

⚠ WARNING: Electrical Shock Hazard

Do not use with damaged cord or plug. Use with adequate electrical system that is up to code.

⚠ CAUTION: to Prevent Electric Shock, this product has a three prong grounded plug that must be inserted into a matching properly grounded outlet to reduce the risk of electrical shock. Do not attempt to defeat this safety feature.

⚠ WARNING: to Reduce the Risk of Fire or Electric Shock, do not use this product with any solid-state speed control device.

Fan Assembly

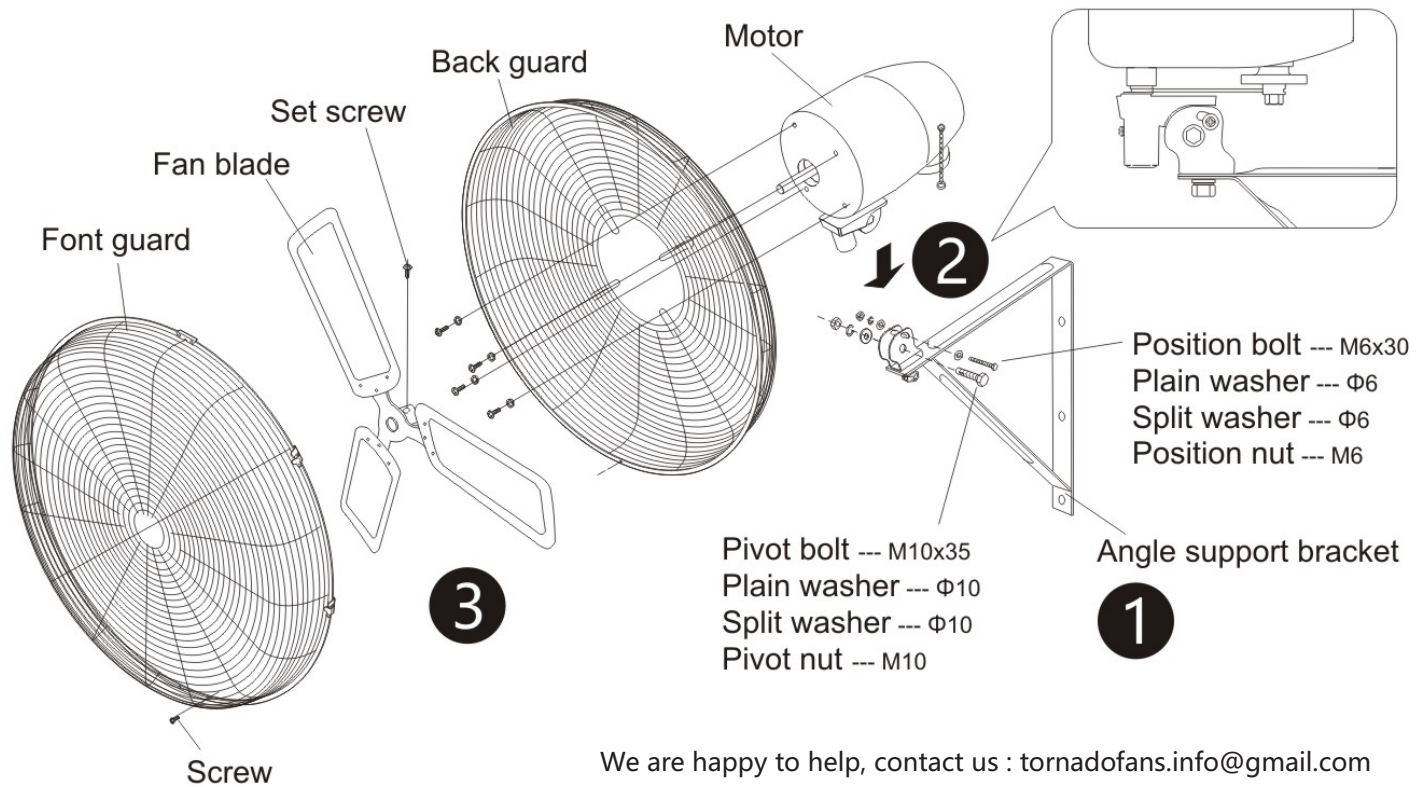

ASSEMBLY INSTRUCTION

Use the following information as a guideline only. It is the user's responsibility to be sure the location and the wall surface can handle the weight of this fan .

The wall fan must be mounted on 12 inch (300mm) thick dry and cement - grouted firm wall or on 4 by 5 inch wood studs / joists.

Use wall bracket as a template for locating the holes to be drilled.

After determining the hole locations, use an appropriate sized drill bit and, drill holes through mounting surface. It is recommended that a minimum of grade 5 fasteners be used. The following are acceptable surfaces for mounting wall mount assembly.

STEEL SURFACE - When mounting to a steel surface, such as vertical I-beam, drill through holes at pre-marked locations, using a 9/32" drill bit. Attach wall mount assembly to mounting surface using 1/4"-20 hex screw, in combination with 1/4" flat washers, 1/4" lock washers, and 1/4"-20 hex nuts.

MASONRY SURFACE - When mounting to a masonry surface use a 1/4" expansion type bolt or 1/4" masonry lag with shield designed to handle the weight of this fan. Drill holes at pre-marked locations using appropriate sized drill bit as recommended for the fastener.

1. Install the angle support bracket on the strong wall.

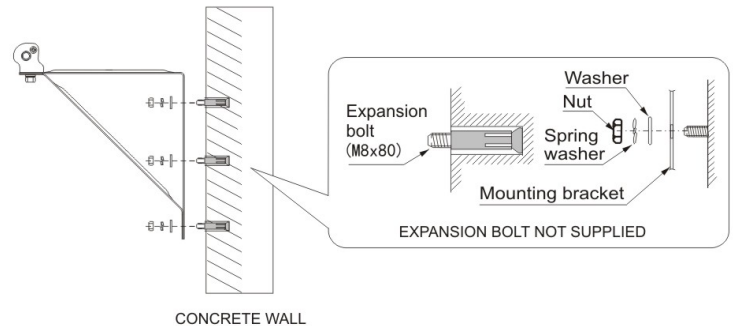

2. Install the fan motor on the angle support bracket.
 3. Assembling the back guard, blade, font guard to the motor.

SETTING OSCILLATING MODE

1. To oscillate the fan, loosen the thumb screw on the oscillation rod and move to the end of the clutch plate. Tighten the screw to lock the position. (See Figure A.)
2. To stop the oscillation, loosen the thumb screw on the oscillation rod and move to the center of the clutch plate. Tighten the screw again to lock the position. (See Figure B.)

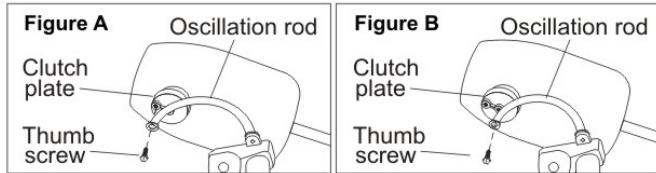

TO ADJUST AIRFLOW UPWARD OR DOWNWARD

Loose pivot nut & position nut for adjusting the desired tilt angle of fan head, and fix it again.

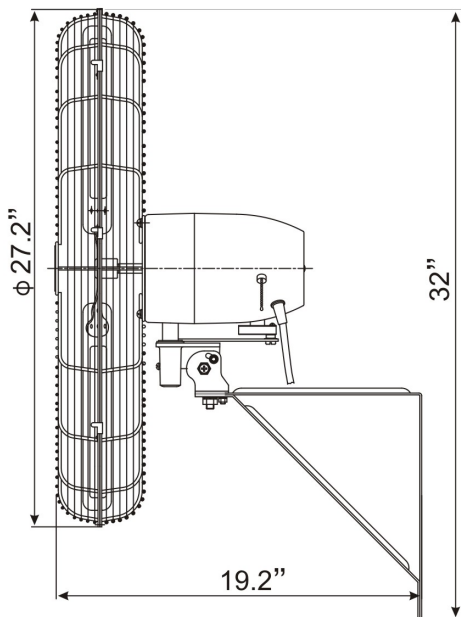
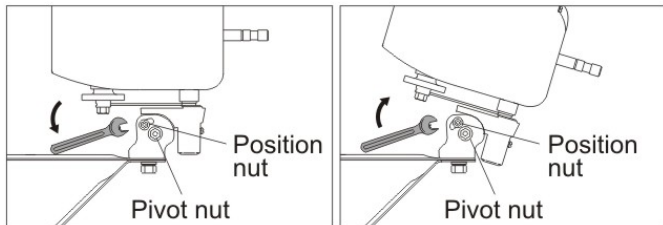

We are happy to help, contact us : info@tornadofans.com

Usage:

Fan operation: Always operate the fan in the upright position following all instructions and recommendations listed in this manual.

Fan location: Place the fan in the area of the room that will provide proper fan cooling.

Fan connection: Plug fan directly into 120 volt A.C., 60 Hz wall outlet. Be sure plug fits tightly in outlet. A loose connection may cause overheating and damage to the plug or fan.

Note: To prevent overloading a circuit, do not plug the fan into a circuit that is servicing other electrical needs.

Speed control: Select air speed by setting switch to either low-medial-high-off.

- OFF
- LOW
- MED
- HIGH

Care and Maintenance

Cleaning: CAUTION-Before cleaning the fan be sure to disconnect power cord from the plug. Clean the grille surface with a clean damp cloth. Do not use harsh chemical or abrasive cleaners. DO NOT IMMERSE THE FAN OR ANY WIRES IN WATER. Replace front grille before fan use. Allow fan to dry completely before use. Periodic grille cleaning with a vacuum will prevent dust build up. The motor is sealed and does not require any interior maintenance, cleaning or lubrication.

Maintenance: The Internal motor bearings are permanently lubricated at the factory and do not require any additional lubrication.

Repair: DO NOT OPERATE THE FAN WITHOUT THE GRILLE IN PLACE. DO NOT USE THE FAN IF IT HAS MALFUNCTIONED OR BECOME DAMAGED IN ANY WAY.

Storage: Keep original carton for storage of the fan. Coil and tie the power cord to avoid damage during storage.

LIMITED ONE-YEAR WARRANTY

Hexago LLC warrants this product to be free of defects in material and workmanship for the applications specified in the Owner's Manual for a period of 12 months for the whole fan from date of purchase. This warranty only applies to the original purchaser of this product.

This warranty excludes damage, accidental or otherwise, to the unit not caused by a defect in material or workmanship.

The warranty also excludes damage caused by misuse, tampering, modification, missassembly, repairs or alternations, or failure to adequately maintain and care for the unit. Operating this product under any conditions others than those recommended or at voltages other than indicated will also void this warranty. For warranty issues, contact the place of purchase for repair/ replacement opportunities. The original dated receipt or proof of purchase must accompany all returns.

All warranties, expressed or implied, are limited for 12 months for the whole fan from the date of purchase. Please contact us at www.tornadofans.com if you have any questions. Tornado is a registered trademark of Hexago LLC.

Some states do not allow for the limitation or exclusion of incidental or consequential damages, or do not allow limitation on implied warranties. The above limitations and exclusions may not apply to you. This warranty gives you specific legal rights, and may also include other rights that vary state by state.

Customer service email: info@tornadofans.com

Website: www.tornadofans.com

FOR CALIFORNIA CONSUMERS  **WARNING:** This product can expose you to chemicals including lead and phthalates, which are known to the State of California to cause cancer and birth defects or other reproductive harm. For more information go to www.P65Warnings.ca.gov.

202112