



Worthouse.[®]

Metal Roofing Manufacturing

Roofing Gutters Soffit

MODULAR METAL ROOFING TILES

STEEL GUTTER SYSTEM

PVC SOFFIT

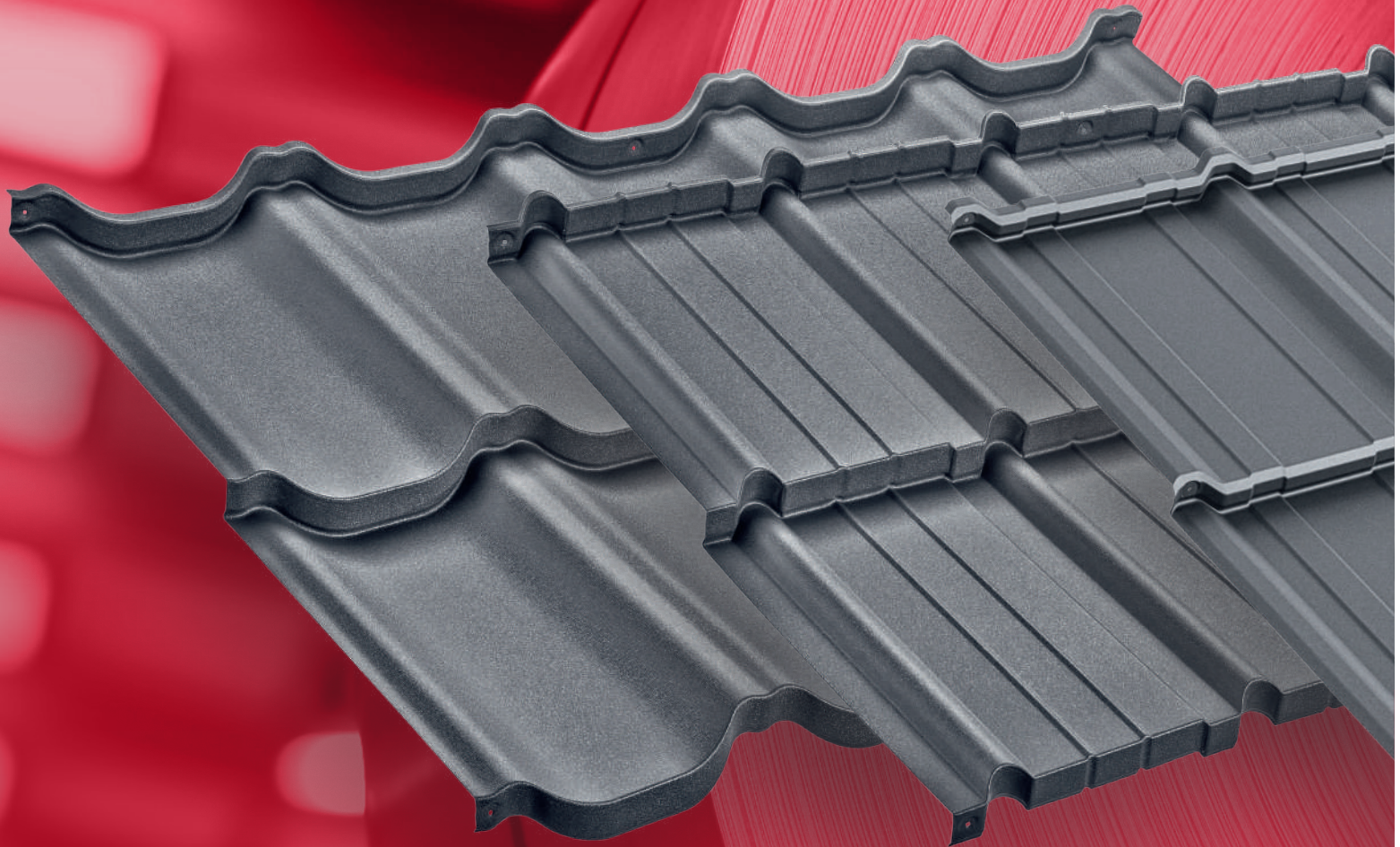

26 GAUGE, G90

Supre, Ultra and Como^{NEW} are made
from **ArcelorMittal** steel
– the largest steel producer in the world



ArcelorMittal

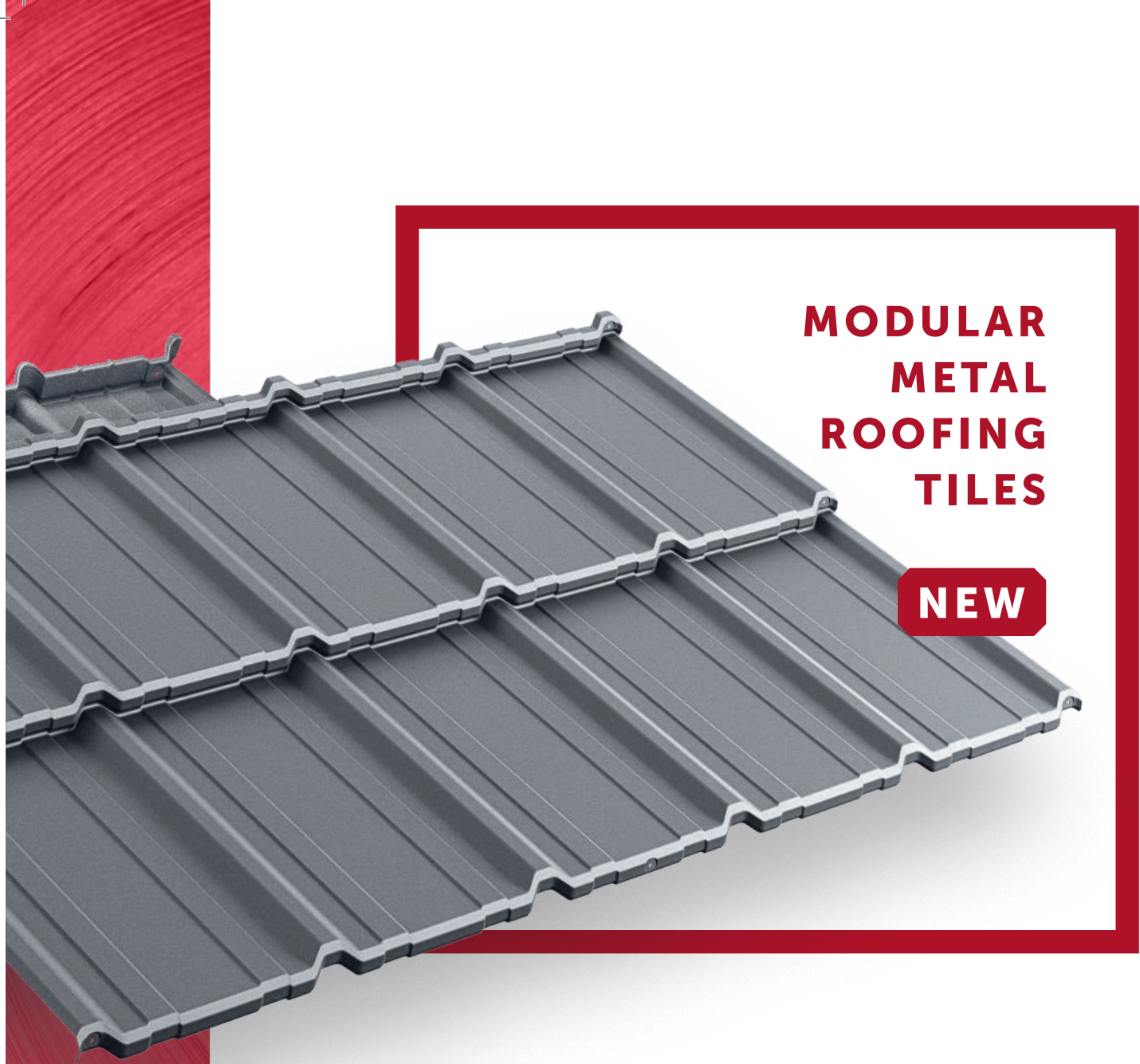

MODULAR METAL ROOFING TILES

NEW



Steel is durable

Steel roofing products have nearly twice the lifespan of conventional roofing products



Steel is eco-friendly

Steel can be recycled endlessly, which makes it one of the most environmentally friendly materials



Steel protects

Our steel roofing products have achieved the highest hurricane wind protection, hail impact and fire safety ratings in the US



Extreme weather and impact protection

Against hailstorm, rain, snow, heat and wind

Our products have achieved Class 4 ratings according to the UL 2218 Roof Impact Classifications



Fire protection

We got an "A" in fire protection according to the UL 790 (ASTM E 108) Fire Protection Ratings



High wind protection

We achieved the Class 90 certification for the UL 580 Wind Uplift Resistance test. We have tested our products at wind speeds over 200 mph



The quality of our roofs has been recognized and certified by the Underwriters Laboratories. UL is the largest independent testing laboratory in the world. It is dedicated to promoting safe living and working environments.

MIAMI-DADE COUNTY
APPROVED

TDI



SYSTEM WORTHHOUSE METAL MODULAR ROOF
RECOMMENDED BY ITB – BUILDING RESEARCH INSTITUTE
WARSAW – EUROPEAN UNION
RT ITB – 1292/2020 – NUMBER OF TECHNICAL RECOMMENDATION
ITB EU – SECOND BIGGEST BUILDING RESEARCH INSTITUTE IN EUROPE
1488 – NUMBER OF INSTITUTE'S NOTIFICATION IN EUROPEAN UNION

WORTHHOUSE ROOFS PROTECTS YOUR HOME



Class
90



High wind protection

We achieved the Class 90 certification for the UL 580 Wind Uplift Resistance test. We have tested our products at wind speeds over 200 mph.

Class
4



Extreme weather and impact protection

Against hailstorm, rain, snow, heat and wind. Our products have achieved Class 4 ratings according to the UL 2218 Roof Impact Classifications.

Class
A



Fire protection

We got an "A" in fire protection according to the UL 790 (ASTM E 108) Fire Protection Ratings.

PROTECTIVE SHIELD

Noble Matt

Covered with the Noble Matt coating, it effectively protects against long-term wear and provides maximum corrosion resistance in any conceivable application.

Stable and constant

The Noble Matt coating not only protects against discoloration, but also functions as an all weather shield.

It says no to re-roofing

Forget about re-roofing. Supre, Ulta and Como will serve you reliably for generations. The steel and protective shield form a really powerful duo of protection.

Manufactured in color

UP TO **50** YEARS

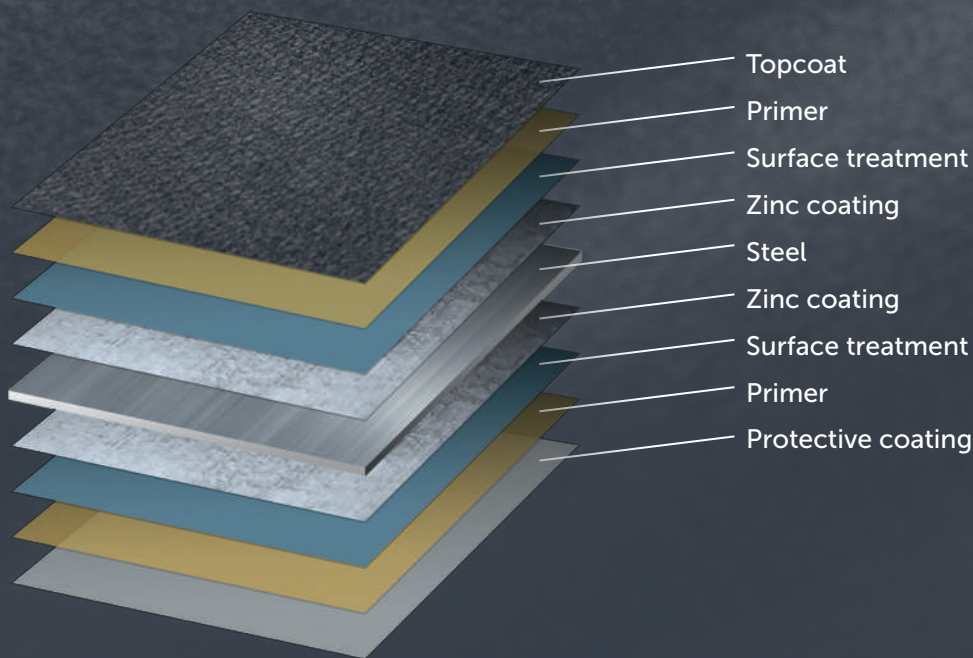

- Topcoat
- Primer
- Surface treatment
- Zinc coating
- Steel
- Zinc coating
- Surface treatment
- Primer
- Protective coating

G90
0.90
oz/ft²

ZINC
275
minimum g/m²

UP TO **30** YEARS



PROTECTIVE SHIELD

Magnelis® **NEW**

Available only for
Modular Metal Roofing Tile
Como

Magnelis® is a unique metallic coating that represents a breakthrough in corrosion protection. It is the best material with numerous uses.

Magnelis® coating has undergone the most severe corrosion performance tests in Daytona Beach laboratories. The results were incomparable with any other coating on the market!

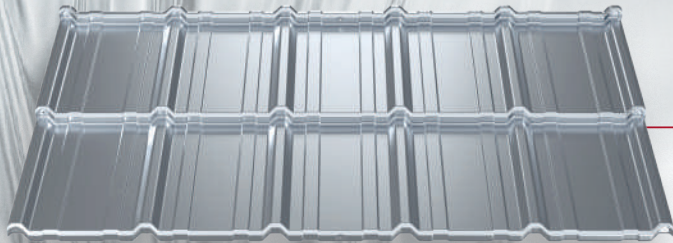

The Magnelis® corrosion performance is a minimum of 3 times greater than Galvanized Steel in all environmental classes!

WORTHHOUSE IS DELIGHTED TO PRESENT TO YOU OUR ROOF OFFERING OF MAGNELIS COATING WITH AN AMAZING WARRANTY

- **30 Year Warranty for C3/C4 environment**
- **20 Year Coastal Warranty for C5 environment**

Corrosion performance – outdoor exposure.
Complementary data in very severe environment
First data after 1 year exposure.

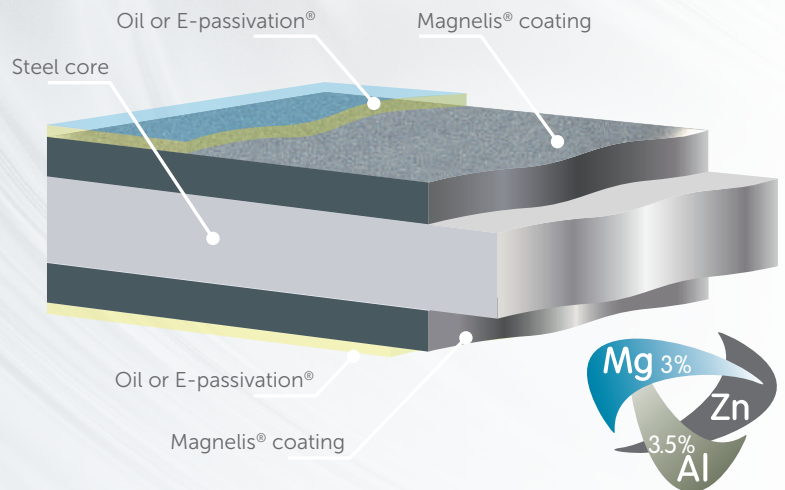
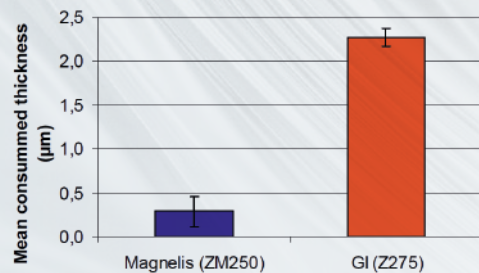



**MODULAR ROOFS
ARE EASY
TO INSTALL**

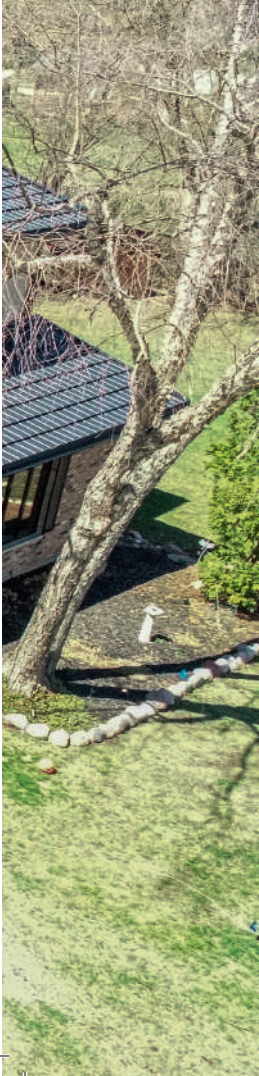
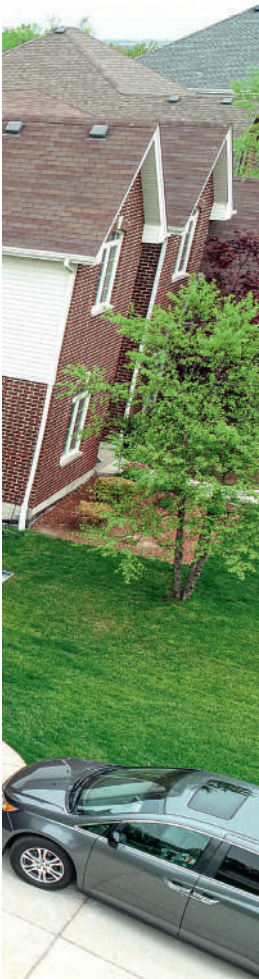

SUPRE

Weight of one pallet:

2920 lb

Quantity per pallet:

350 pcs

Effective surface area of one pallet:

3032 sq. ft



ULTA

Weight of one pallet:

2650 lb

Quantity per pallet:

319 pcs

Effective surface area of one pallet:

2739 sq. ft



COMO

Weight of one pallet:

2980 lb

Quantity per pallet:

352 pcs

Effective surface area of one pallet:

3133 sq. ft



Simple transport

One pallet contains over 3000 sq. ft (Supre, Como), 2700 sq. ft (Ultra) of material – enough to cover an average size roof



Easy to install

Pre-drilled holes and modular assembly speed up installation and reduce mistakes



Cost effective installation

Our products average less than 5% waste during installation compared to industry norms greater than 10%



Pine Green

Noble Matt

NEW



Atlantic Gray

Noble Matt

NEW



Atlantic Sand

Noble Matt

NEW



Take to the sky with Raven Black

Ravens are very intelligent birds, which played an integral role in the mythology of the indigenous peoples of the Pacific Northwest, as well as art and literature. For many cultures the bird was a religious symbol. Some even believed that it was God. Raven Black. The color of freedom

Raven Black



Dare to conquer with Sierra Brown

The Sierra Nevada is a mountain range in the Western United States. Its highest peak – Mount Whitney – reaches an elevation of 14,505 feet. The foothills of this mountain range are home to the California Gold Rush of the 19th century. Sierra Brown. The color of a true conqueror

Sierra Brown



Dive deep into the Pacific Gray

The Pacific is the largest and deepest ocean on Earth. It covers almost 1/3 of the earth's surface. Its depth reaches more than 35 thousand feet. Pacific Gray. The color of mystic nature

Pacific Gray

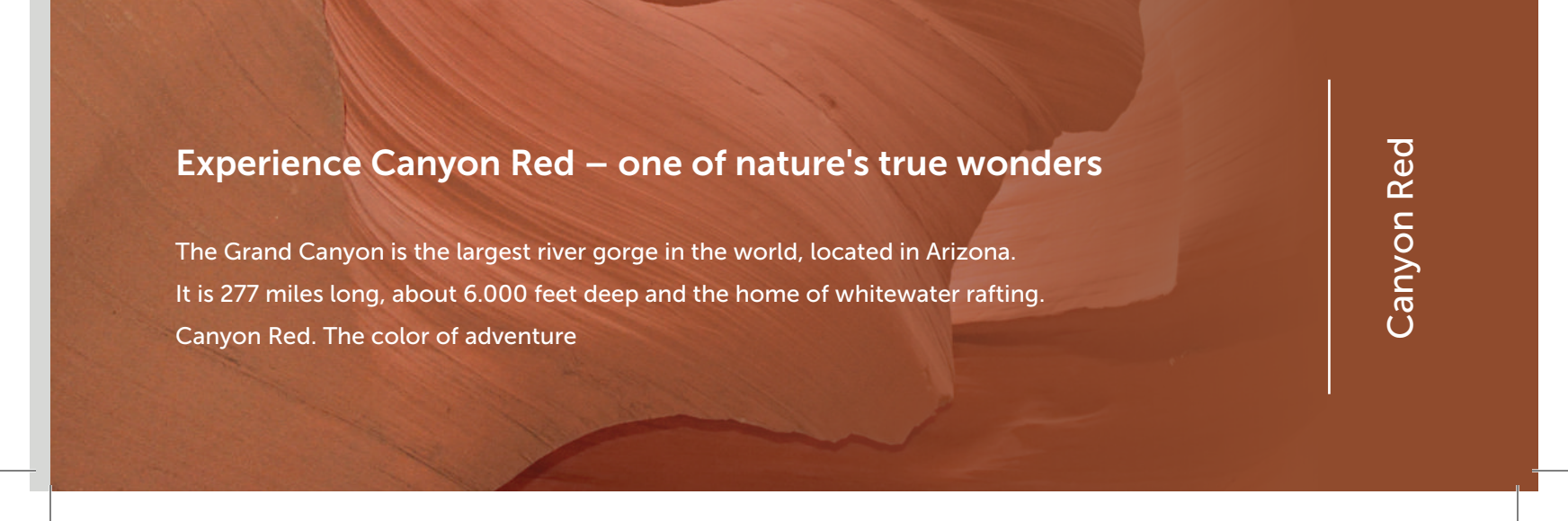

Experience Canyon Red – one of nature's true wonders

The Grand Canyon is the largest river gorge in the world, located in Arizona. It is 277 miles long, about 6,000 feet deep and the home of whitewater rafting. Canyon Red. The color of adventure

Canyon Red

Como^{NEW} makes your home beautifully protected



INCREASED HURRICANE RESISTANCE



SYMMETRICAL SHAPE

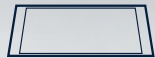

LARGER COVERING AREA
ONLY 11 PANELS PER 1 SQ EFFECTIVE COVER

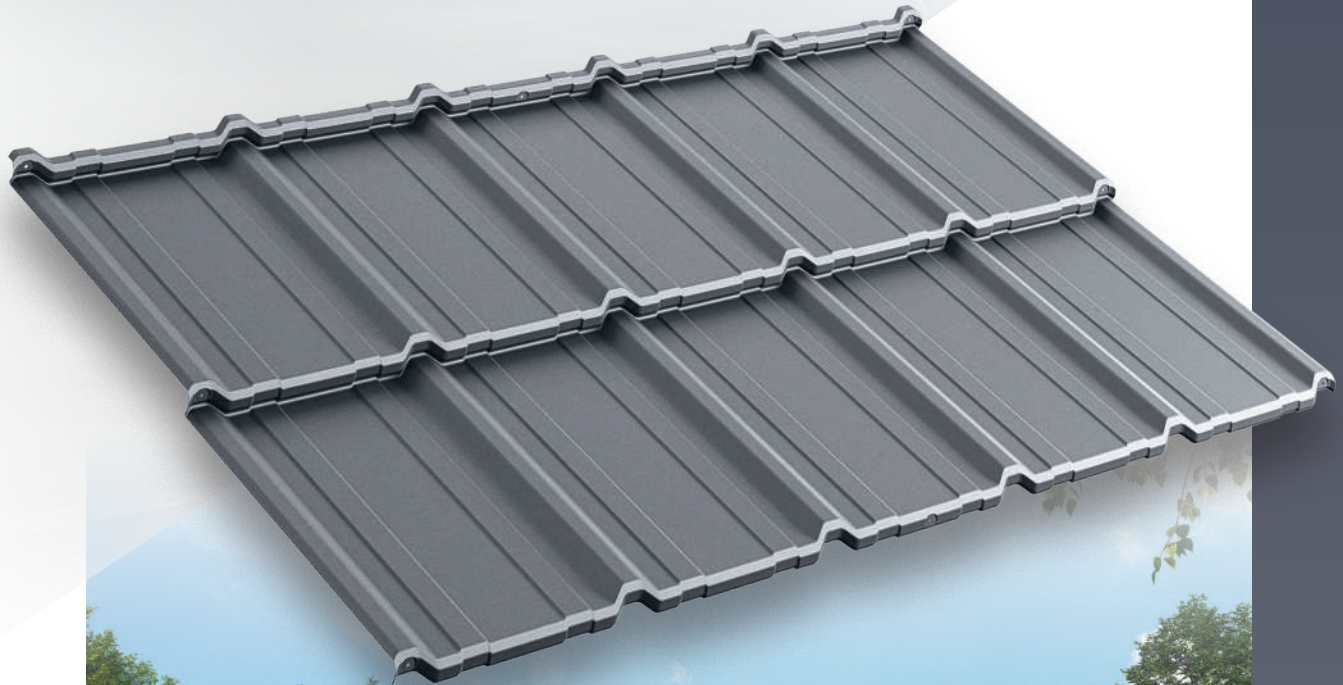

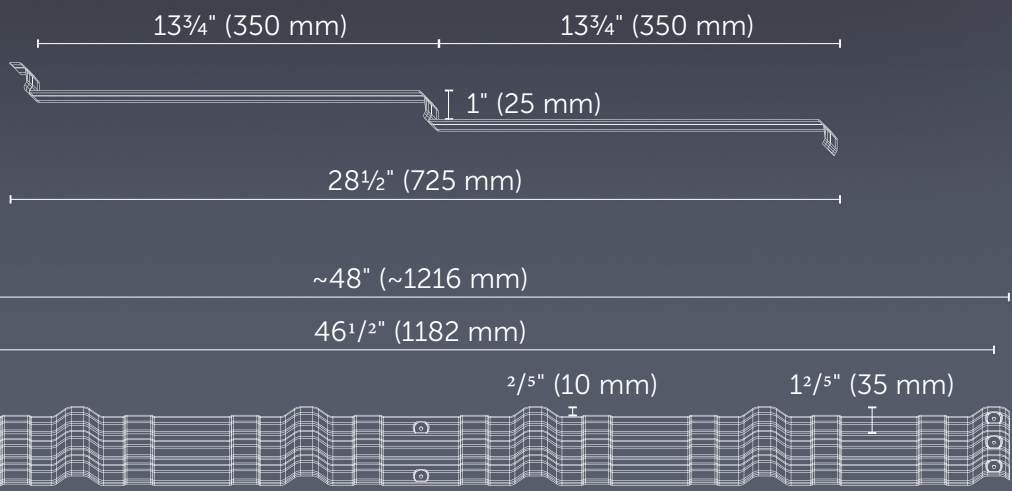

Como

Effective width

3.88 ft

1182 mm

Total width

3.99 ft

1216 mm

Weight per piece

8.16 lb

3.7 kg

Effective surface area of one sheet

8.9 sq. ft

0.827 sq. m

Quantity per pack

352 pcs

Effective surface area of one pack

3133 sq. ft

291.104 sq. m

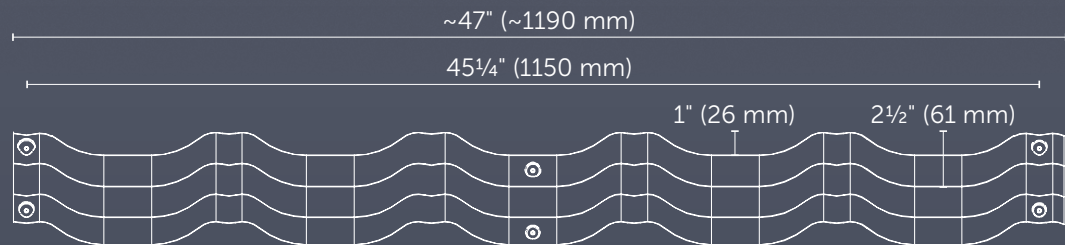
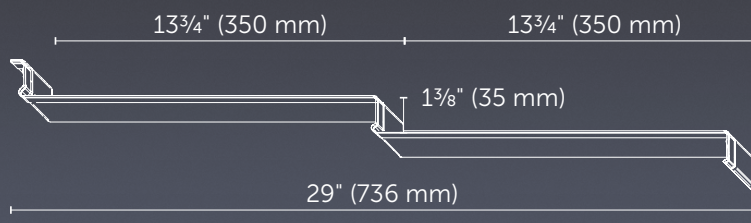
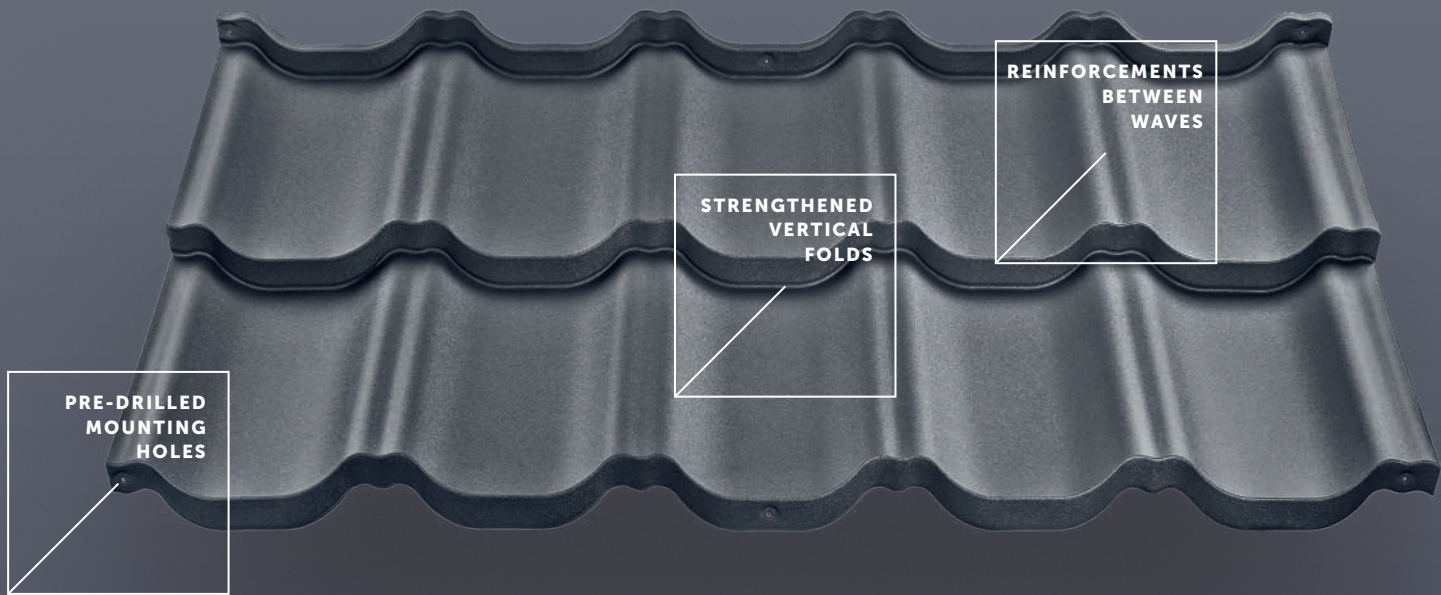

Supre



Effective width

3.77 ft
1150 mm

Total width

3.9 ft
1190 mm

Weight per piece

8.16 lb
3.7 kg

Effective surface area of one sheet

8.66 sq. ft
0.805 sq. m

Quantity per pack

350 pcs

Effective surface area of one pack

3032 sq. ft
281.75 sq. m

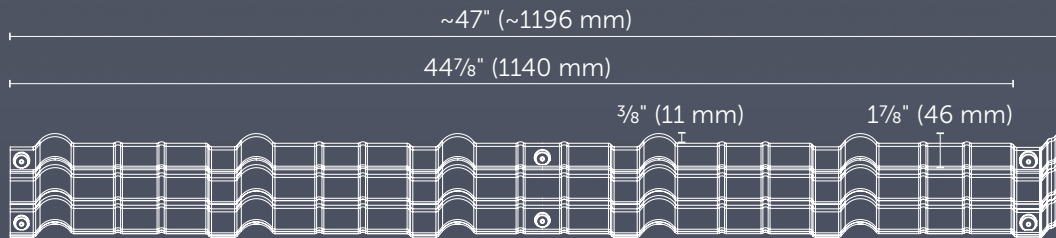
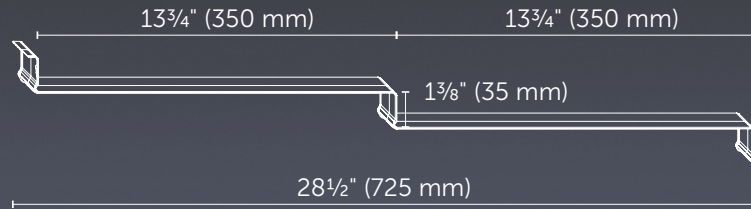
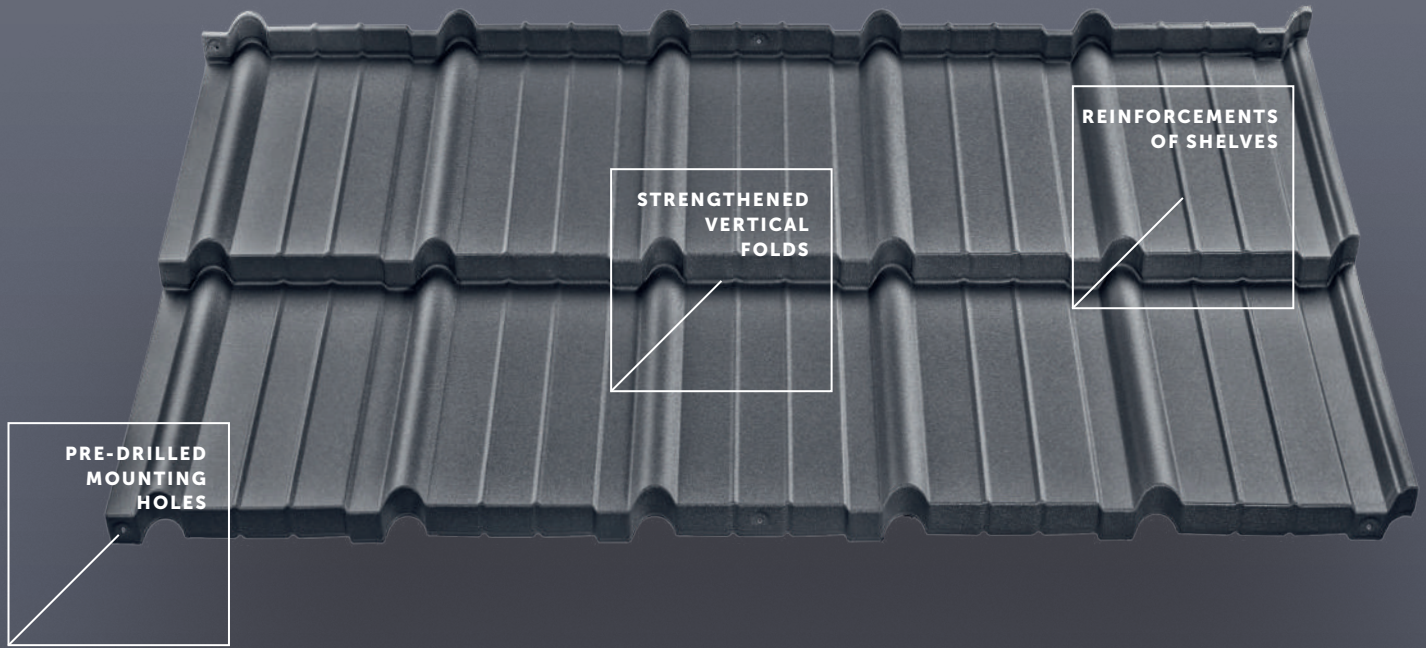

Ultra



Effective width

3.74 ft

1140 mm

Total width

3.92 ft

1196 mm

Weight per piece

8.16 lb

3.7 kg

Effective surface area of one sheet

8.59 sq. ft

0.798 sq. m

Quantity per pack

319 pcs

Effective surface area of one pack

2739 sq. ft



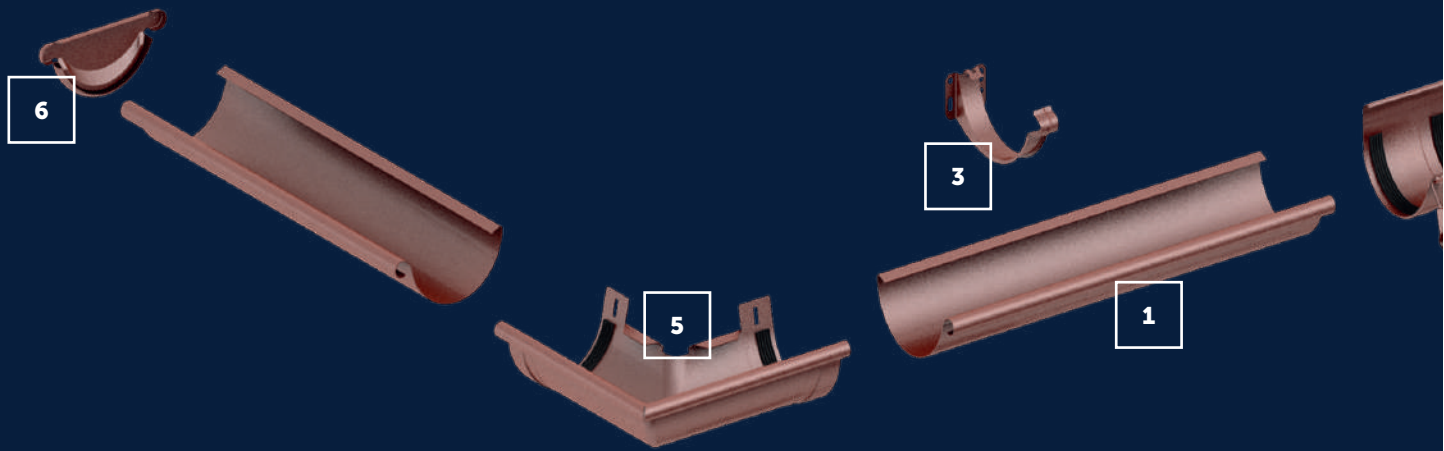

254.56 sq. m



SYSTEM

5³/₄" / 3¹/₂"

COLORS

- 
Brown ~RAL 8028/8017
GreenCoat RWS 434
- 
Graphite ~RAL 7011
GreenCoat RWS 087
- 
Black ~RAL 9005
GreenCoat RWS 015
- 
White ~RAL 9002
GreenCoat RWS 001
- 
Brick-red ~RAL 8004
GreenCoat RWS 742

30
YEAR
WARRANTY

GREENCOAT® RWS
COLORFUL STEEL

SSAB

The colors shown are illustrative and may vary from the actual ones.

**RAIN-THIRSTY
FLAMINGO**

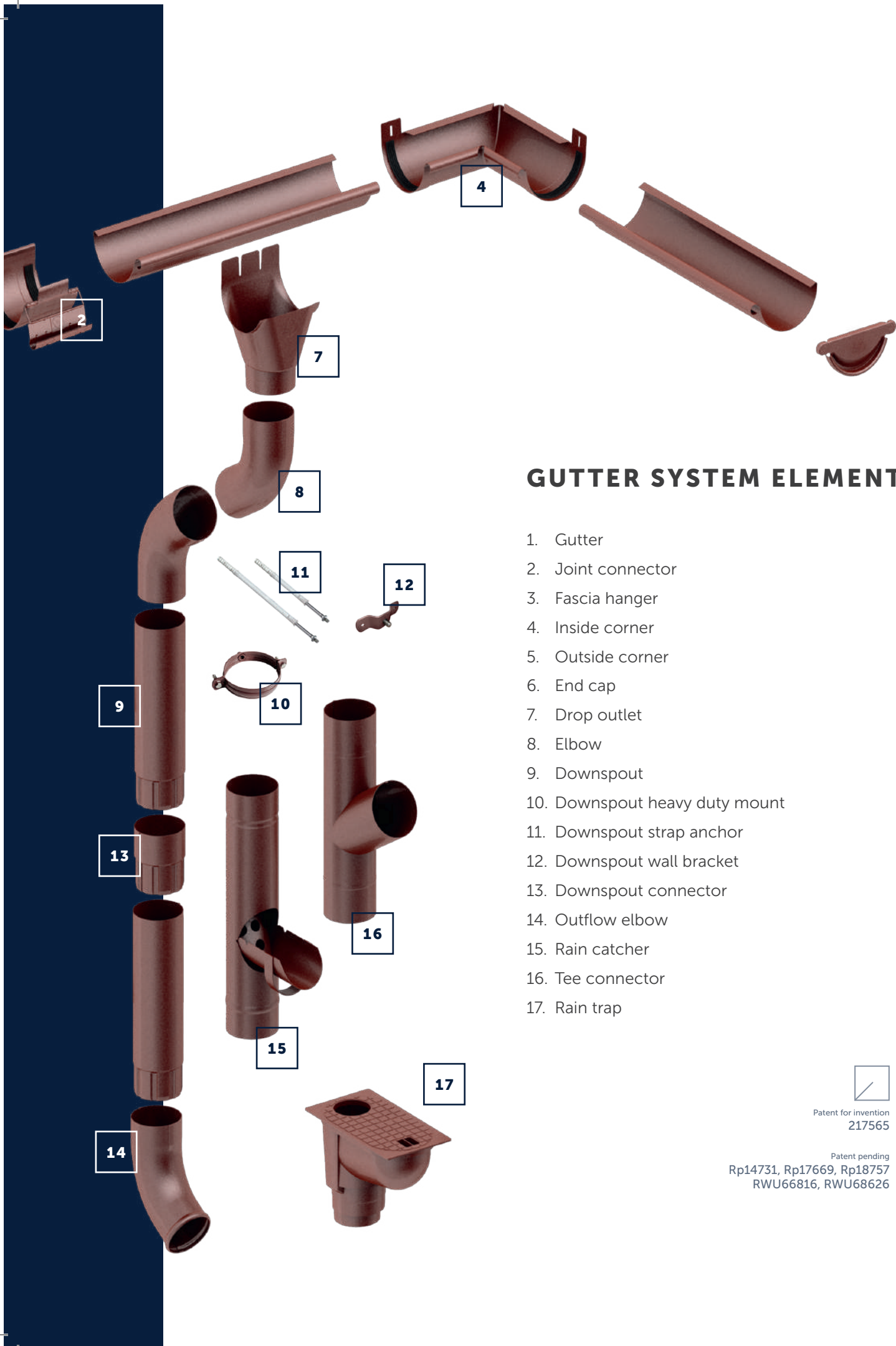

GUTTER SYSTEM ELEMENTS

1. Gutter
2. Joint connector
3. Fascia hanger
4. Inside corner
5. Outside corner
6. End cap
7. Drop outlet
8. Elbow
9. Downspout
10. Downspout heavy duty mount
11. Downspout strap anchor
12. Downspout wall bracket
13. Downspout connector
14. Outflow elbow
15. Rain catcher
16. Tee connector
17. Rain trap



Patent for invention
217565

Patent pending
Rp14731, Rp17669, Rp18757
RWU66816, RWU68626



Excellent tightness

Flamingo elements are moulded in specially designed, patented moulds. Forget about the leaks when assembled



Only the best materials

Flamingo was manufactured from GreenCoat RWS (Rain Water System) steel produced by SSAB – a Swedish global steel company. GreenCoat RWS was developed specifically to create high quality gutter systems

It has a double sided coating and is exceptionally durable. Coatings used in GreenCoat RWS products include polymer grains, which improve the surface scratch resistance



Evenness for years

Flamingo has a 30-year warranty for the C1-C4 environmental class (industrial and coastal areas with a high aggressiveness of the corrosive environment)



Safe transport and storage

Flamingo elements are factory-protected with foil. We transport it in specially designed packaging and care about the highest standard of storage

GUTTER



JOINT CONNECTOR

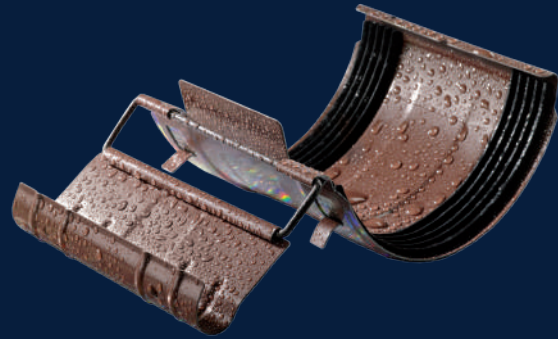

DROP OUTLET



INSIDE CORNER

90°

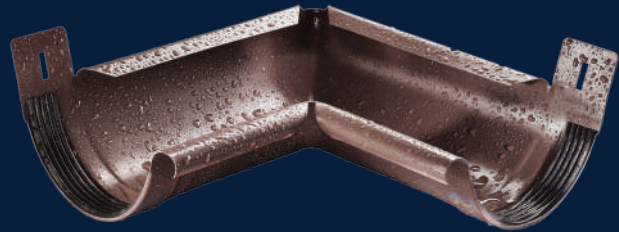

OUTSIDE CORNER

90°



FASCIA HANGER



END CAP



DOWNSPOUT



**DOWNSPOUT
HEAVY DUTY
MOUNT**

DOWNSPOUT CONNECTOR



ELBOW

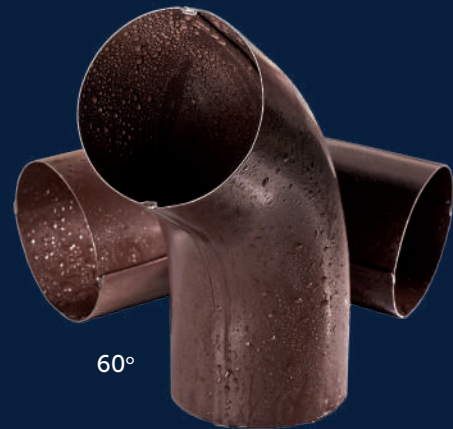

60°

TEE CONNECTOR

RAIN CATCHER

OUTFLOW ELBOW



60°





High resistance to environmental conditions

GreenCoat RWS products are a lightweight construction material with a beautiful shine. They are very resistant to corrosion, UV rays and scratches



Complete steel roof

Flamingo is ideally suited with Worthouse Modular Roofing Tiles



Easy and fast assembly

Flamingo components are made with care for the smallest detail and fit together perfectly, making the assembly fast and easy



Extra strong gutter hangers

Flamingo hanger can easily carry weight of 165 lbs

G90
0.90
oz/ft²
ZINC
275
minimum
g/m²

The system is made of the best quality steel covered with zinc 0.90 oz/ft²



Proven system

It is the best system for metal roofing. Recommended by roofers. Flamingo has been a success for many years



Gold Medal MTP BUDMA 2010
for the Flamingo Steel Gutter System

DIMENSIONS

Covering width

12"

306 mm

Panel height

1/2"

12.2 mm

Panel length

9' 10"

3000 mm

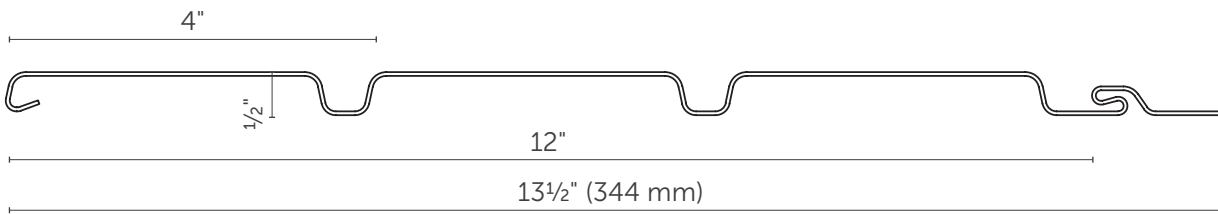

COLORS

Traditional

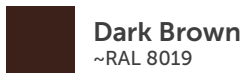
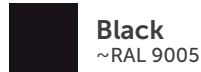

Wood grain



The colors shown are illustrative and may vary from the actual product.

PVC SOFFIT

STANDARD PANEL

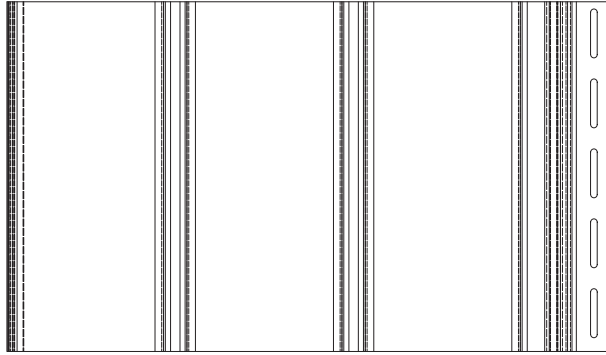

VENTED PANEL

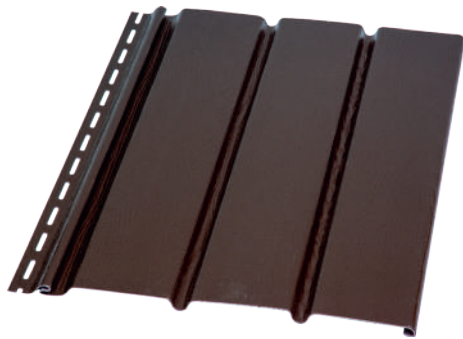
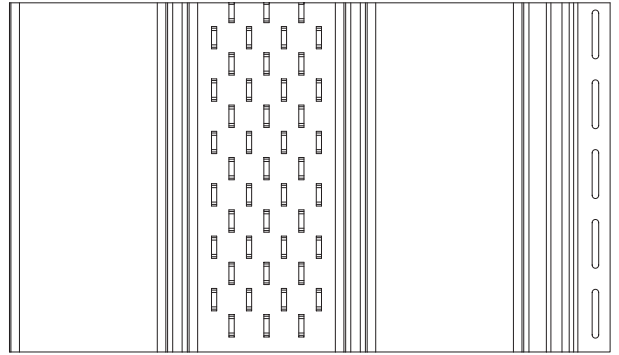

Traditional

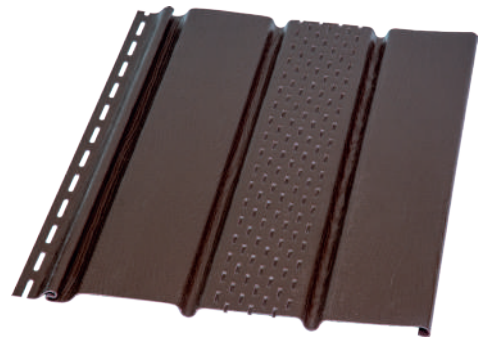

Wood grain

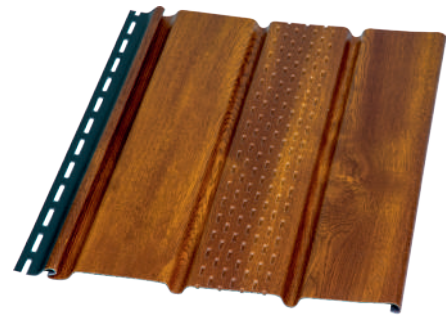

J-channel

Traditional — Wood grain



H-channel

Traditional — Wood grain

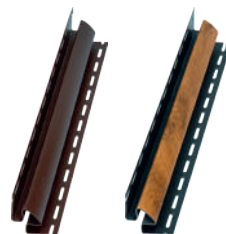

Inside corner

Traditional — Wood grain



Outside corner

Traditional — Wood grain

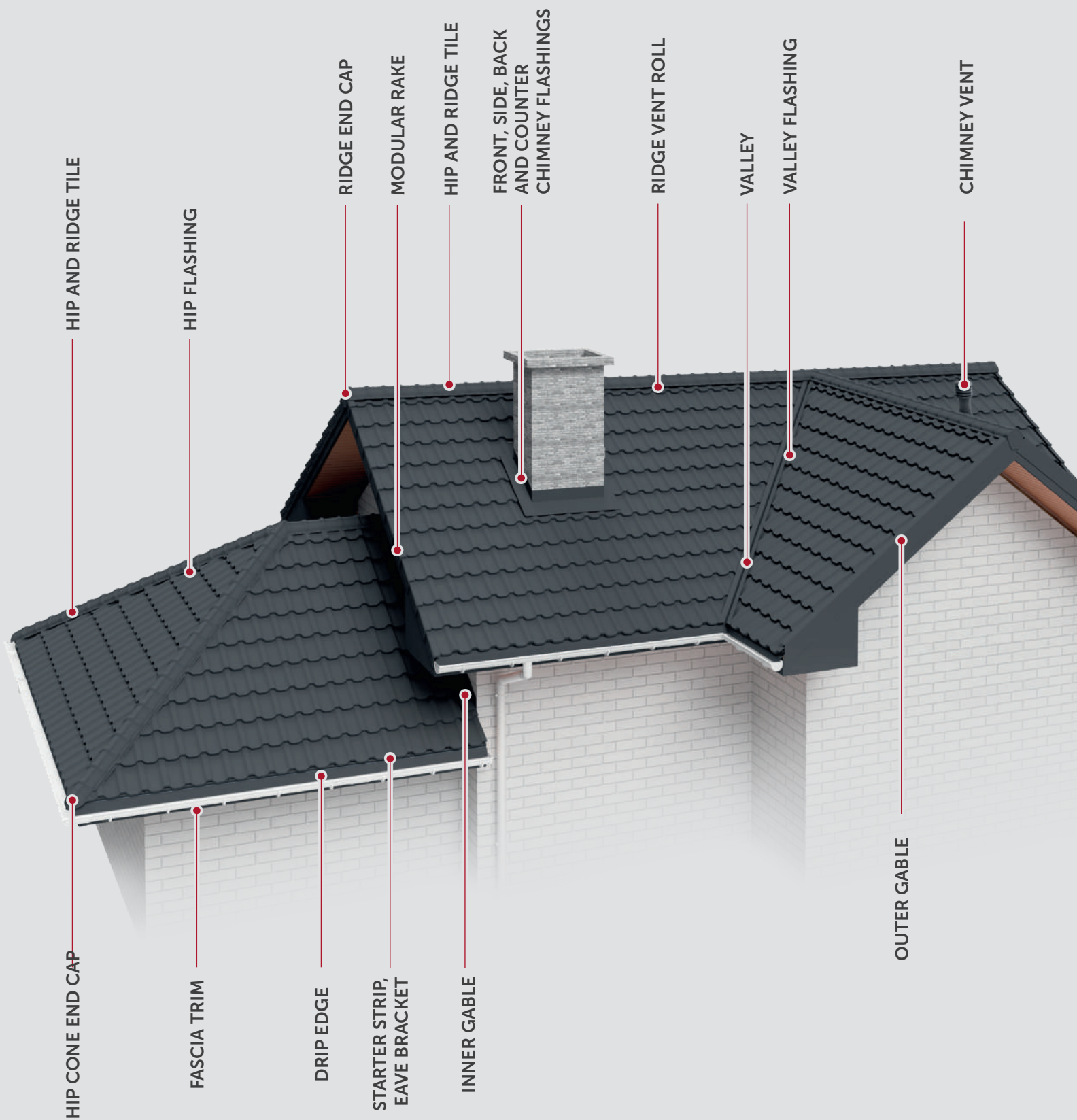

ACCESSORIES

#smartmetalroofing

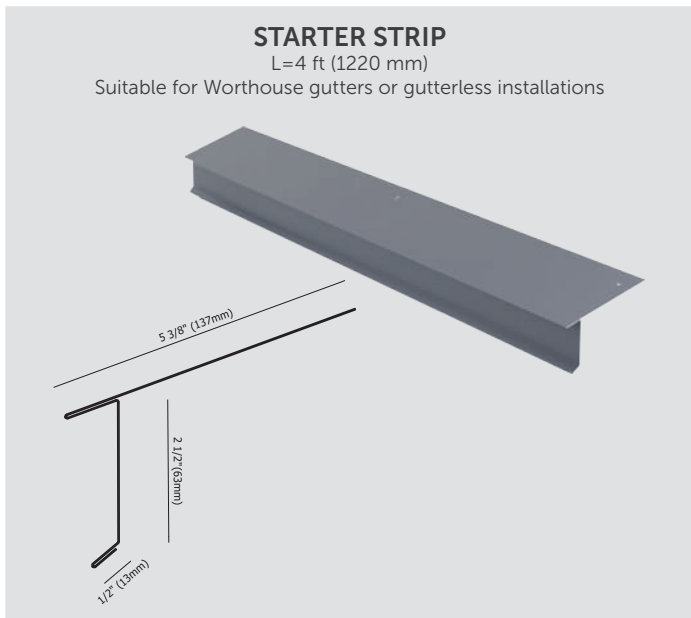
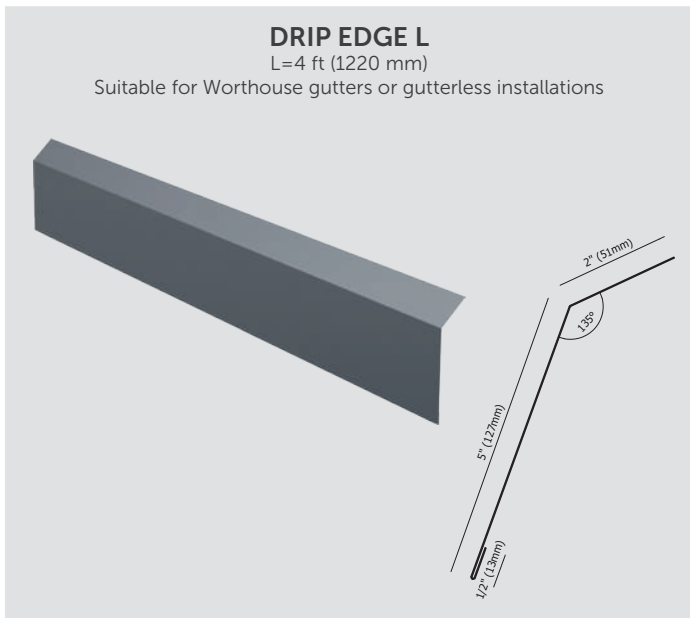
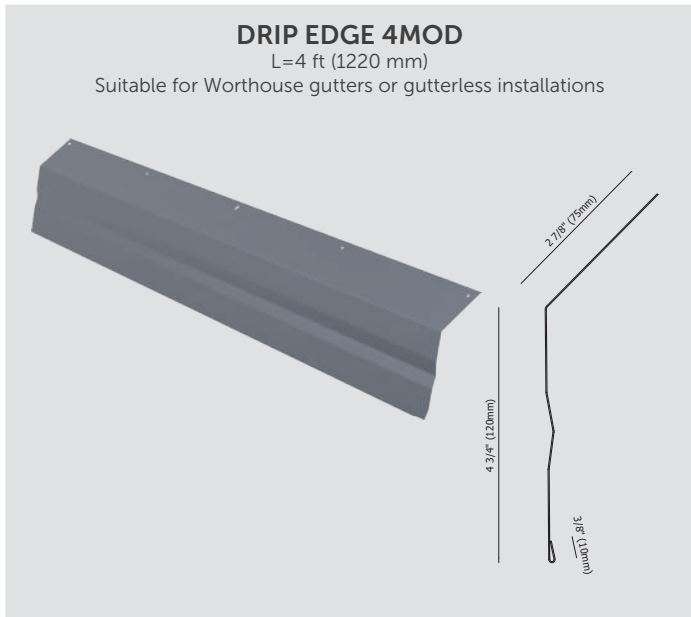
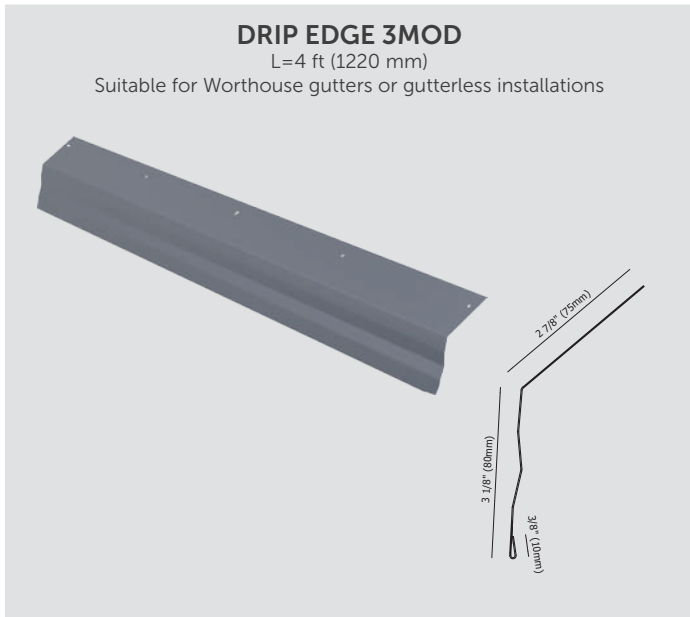
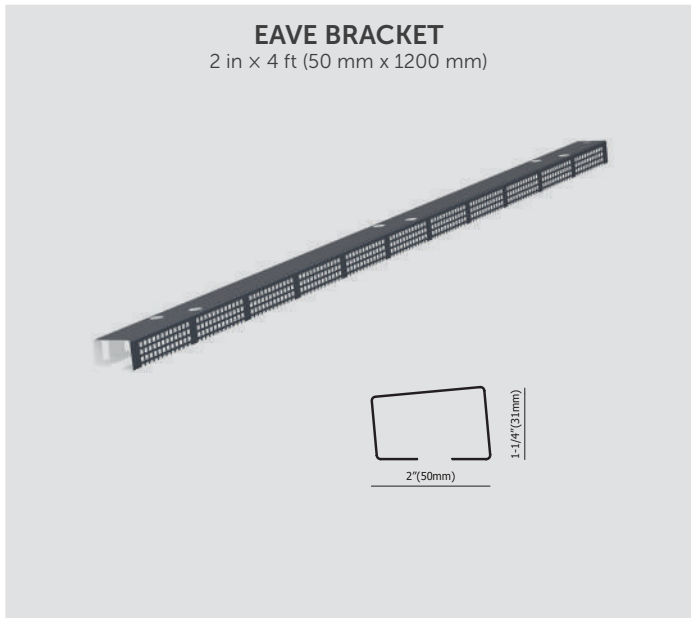
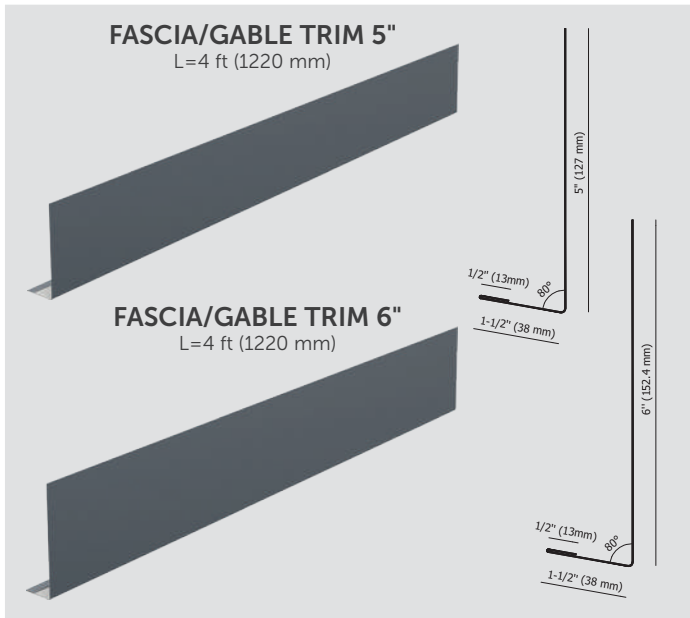

MODULAR RAKE FOR SUPRE

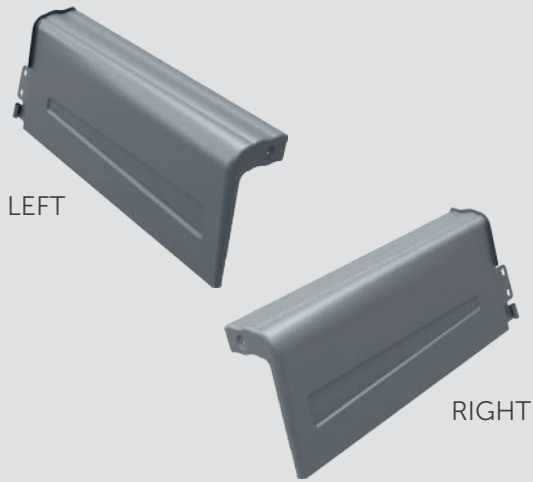

MODULAR RAKE FOR ULTA

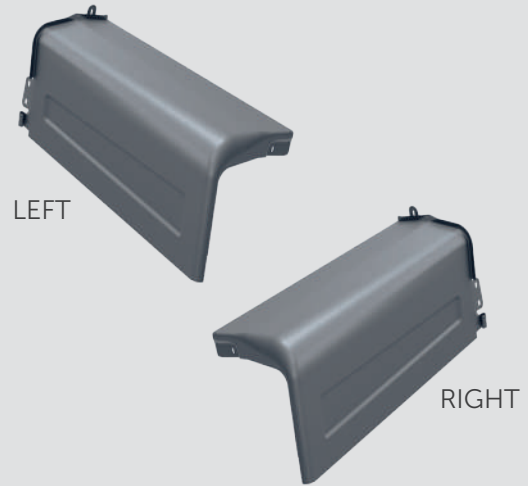

INNER GABLE L=4 ft (1220 mm)

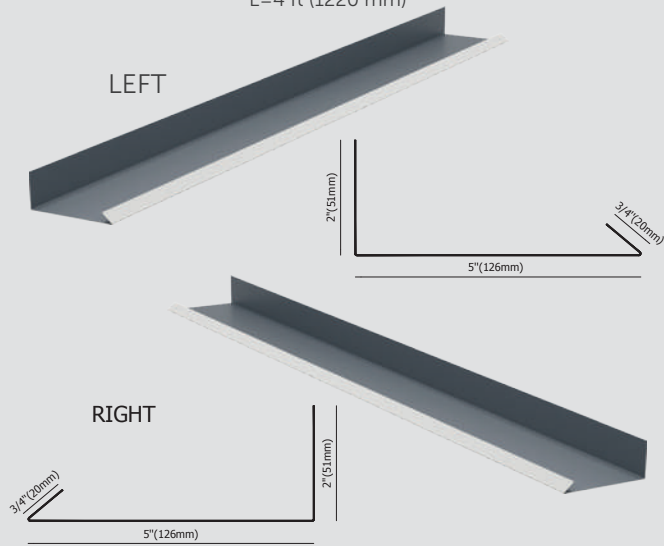

OUTER GABLE 3/4 L=4 ft (1220 mm)

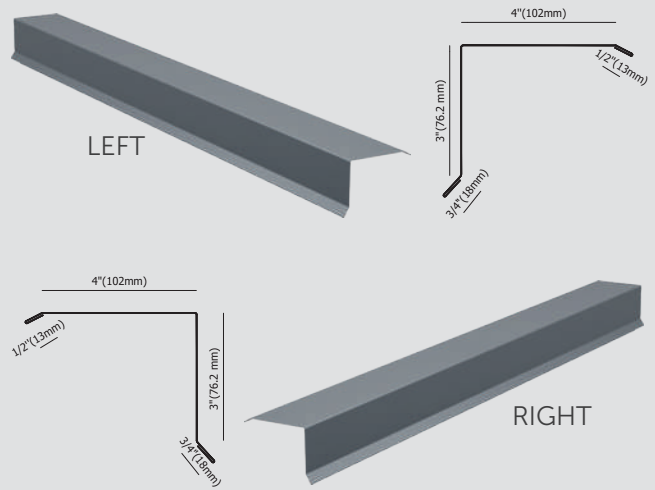

OUTER GABLE 4/4 L=4 ft (1220 mm)

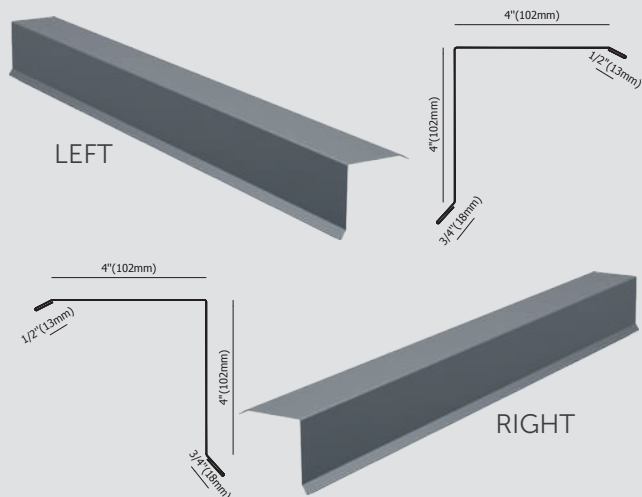

VALLEY-9
L=4 ft (1220 mm)

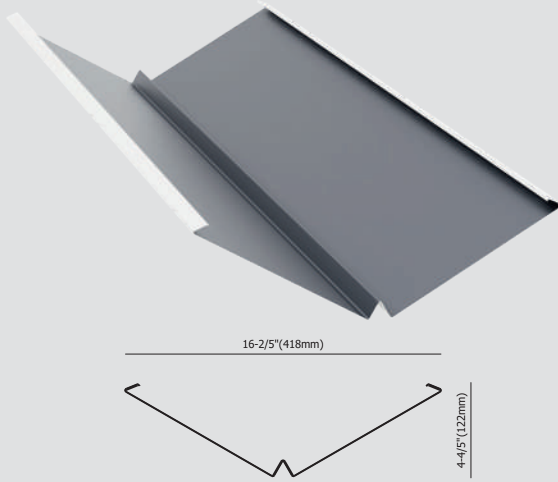

VALLEY FLASHING FOR SUPRE/ULTRA/COMO
L=4 ft (1220 mm)

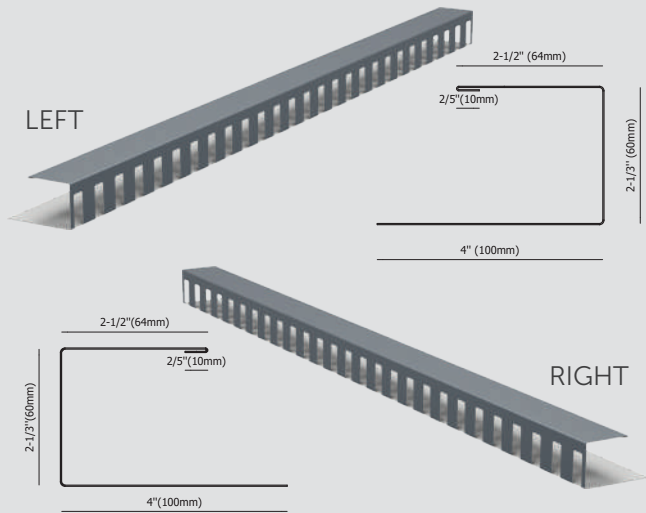

**SIDE CHIMNEY FLASHING
(OUTER DORMER FLASHING)**
L=4 ft (1220 mm)

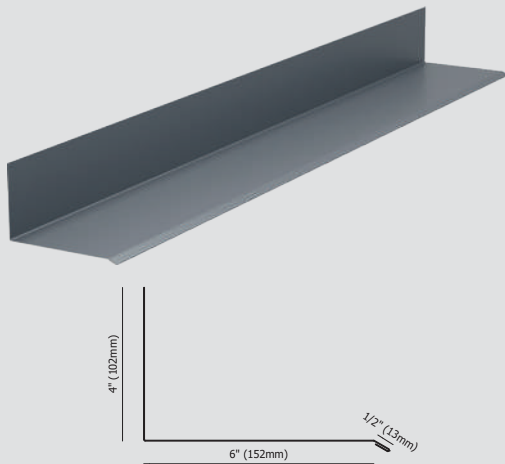

BACK CHIMNEY FLASHING
L=4 ft (1220 mm)

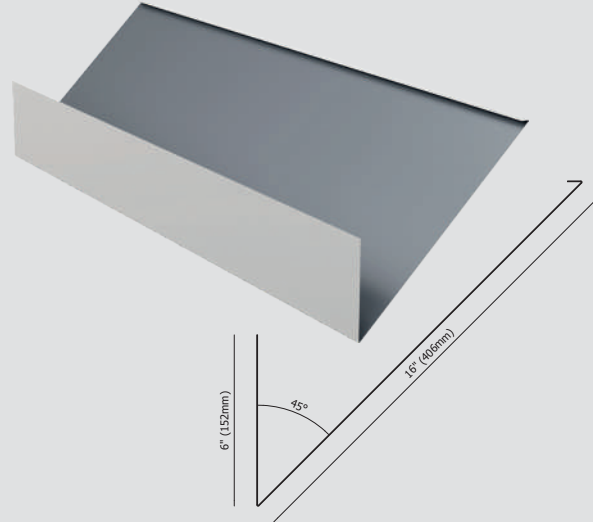

FRONT CHIMNEY FLASHING
L=4 ft (1220 mm)

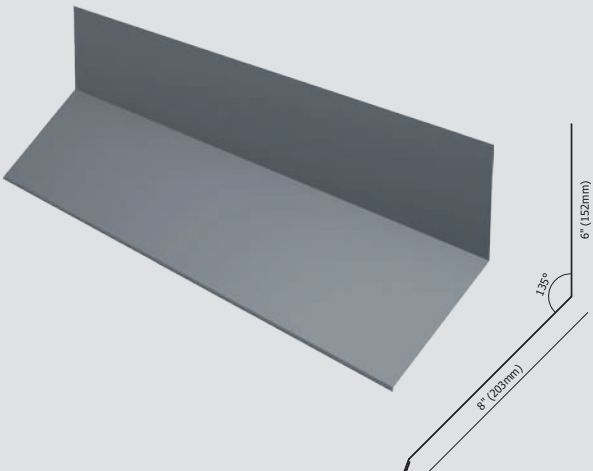

COUNTER FLASHING
L=4 ft (1220 mm)

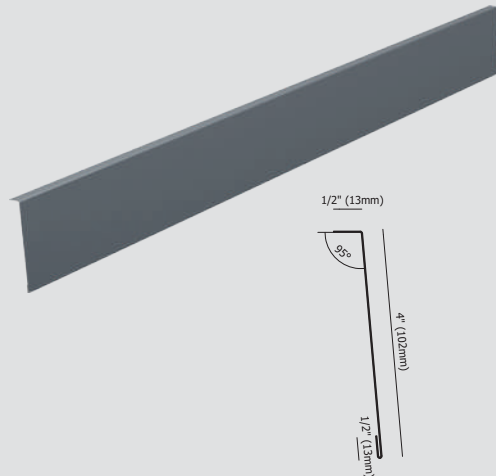

HIP AND RIDGE TILE FOR SUPRE/ULTA/COMO

L=49" (1250 mm)

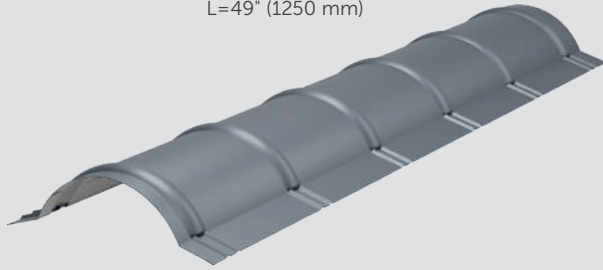

RIDGE END CAP

5.35 in x 0.71 in x 3.78 in
(212 mm x 18 mm x 96 mm)

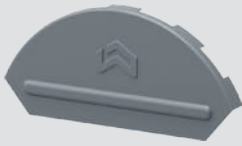

HIP CONE END CAP

12.5 in x 8 in x 3.25 in
(320 mm x 220 mm x 80 mm)



HIP AND RIDGE TILE LUX FOR SUPRE

L=45.08" (1145 mm)

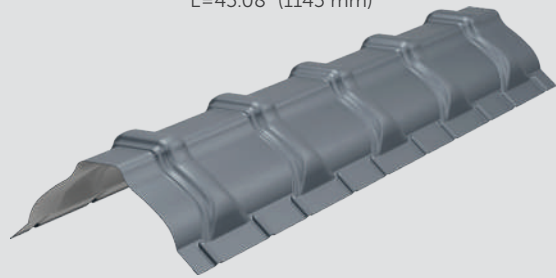

RIDGE END CAP RC-LUX



HIP END CAP RC-LUX

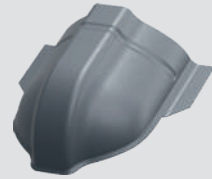

HIP AND RIDGE TILE TOP FOR ULTA

L=4 ft (1220 mm)

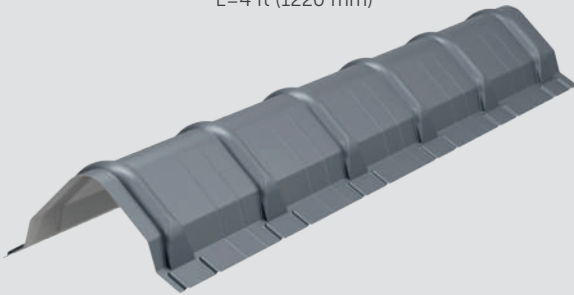

RIDGE END CAP RC-TOP

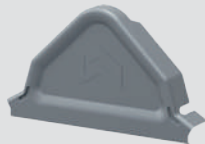

HIP AND RIDGE TILE FLAT FOR ULTA

L=4 ft (1220 mm)

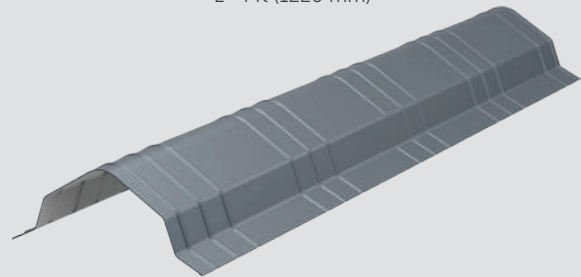

RIDGE END CAP RC-FLAT

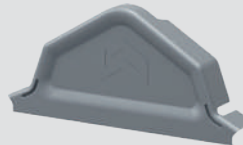

HIP CONE END CAP RC-FLAT

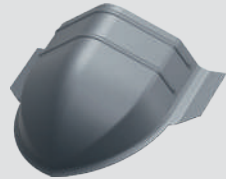

HIP FLASHING HPL

L=45.08" (1145 mm)

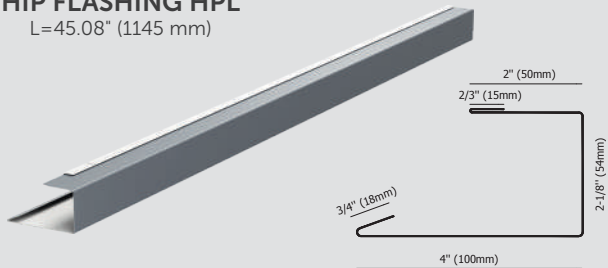

HIP FLASHING HPR

L=45.08" (1145 mm)

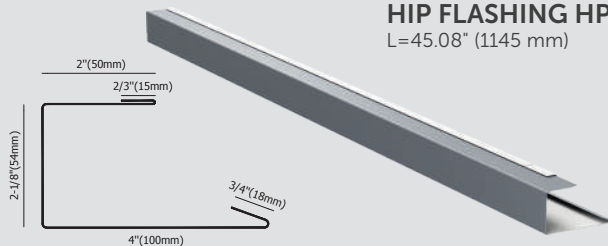

NOBLE MATT COATED FLAT SHEET

4' x 10' (1250 mm x 3050 mm)

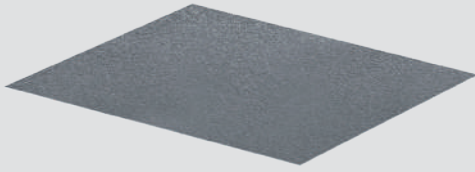

NOBLE MATT COATED STEEL COIL

2 x 50 ft (625 mm x 15.24 mb)



RIDGE VENT ROLL

12 in x 16.5 ft (310 mm x 5 mb)

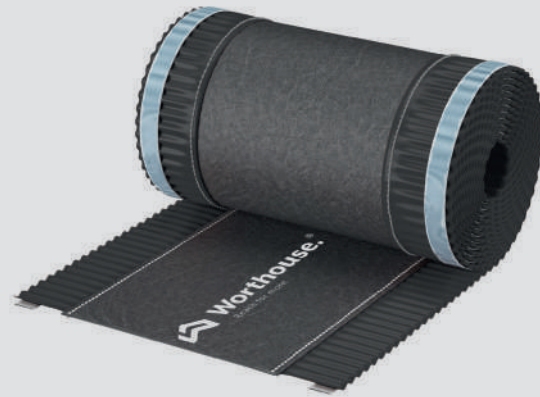

SEALING FOAM TAPE

0.4 in x 1.8 in x 10 ft 10 in (10 mm x 45 mm x 330 cm)



SNOW GUARD

9.25 in x 5.12 in x 3.15 in (235 mm x 130 mm x 80 mm)



**CHIMNEY VENT
UNINSULATED**



UNIVERSAL

SELF-DRILLING FASTENERS

Available in Galvanized Steel, Stainless Steel and Stainless Cap Head

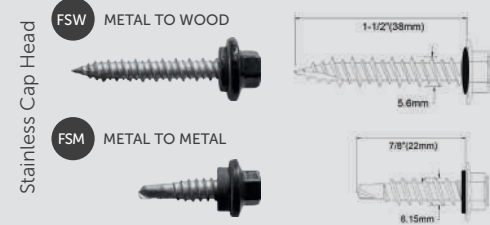
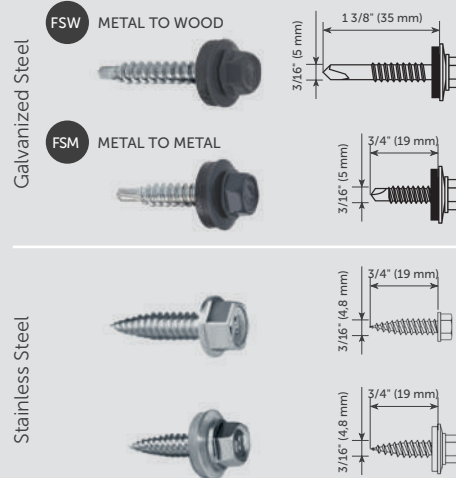

In business for more than 30 years

One of the largest companies of its kind in Europe. Privately owned with six automated mass production manufacturing facilities. 1300 employees. Successfully covering 35% of overall rooftops in Europe.

Worthouse products are in 41 countries around the world. North America headquarters is located in Waynesboro, GA.

Find out more at worthouse.com

Reaching above & beyond for you – approved for sales nationwide

- Miami Dade approval
(Approval No. NoA 17/0221.05)
- Florida Product Approval FL21544/R1
- UL Classified evaluation
UL ER39048/01, UL 1897, UL580
- TDI approval RC-563
- Constant evaluation of our system elements to ensure highest quality solution.

Worthouse Products are a Full Roof System with a Lifetime Warranty.

Engineered for extreme weather and environmental conditions.

A roof that will last as long as its foundation

- Worthouse Modular Metal tile “warrantied duration” is achieved thanks to our source, multinational steel supplier ArcelorMittal providing the strongest raw material available.

For what matters most to you

- With the strongest warranty on the market, Worthouse is ensuring long term protection for your investments.
- Discounted insurance rates up to 25%.

The purchase of a lifetime

- Because your house is worth it.
- With the lifetime warranty life cycle, divided by average costs for materials & installation Worthouse metal roofing achieves very low cost per square per year over its lifetime. Making it one of the most affordable roofing products on the market.

Elegance to stand the test of time



Eco friendly

- Products create less waste, with the market average of 10+%.
- Worthouse tiles are 100% recyclable.
- Allows installation of solar panels.
- Little to no maintenance.

The beauty of seduction

- Worthouse products transform an everyday house into the home of your dreams.
- With an elegant and innovative design these products will improve the appeal and security of your home.



Worthouse.®

Metal Roofing Manufacturing



Extreme weather protection against hailstorm, rain, snow, heat and wind



One pallet – one job



Lightweight and easy to handle



Pre-drilled holes enable self-calibration of roof



Easy and space efficient storage



Quick and efficient installation



Roof angle and partially installed roof corrections



Batch-to-batch color consistency guarantee



Less than 5% material waste



Complete set of accessories



High wind resistance



Fire protection – class A degree

Worthouse.® Inc.

321 Mills Rd.

Waynesboro

GA 30830

T: (706) 955-4005

worthouse@worthouse.com

worthouse.com

