

THE NEW GENERATION LORAWAN SENSORS OF SENSECAP

S210X Sensors User Guide

Version: v1.0.7



Table of Contents

1. Product Introduction	4
2. Part List	5
3. Key Parameters of the Sensor	6
4. LED of Sensor Working Status	7
5. SenseCAP Mate App	9
5.1 Download App.....	9
5.2 How to connect sensor to App.....	9
5.2.1 Create a New Account.....	9
5.2.2 Connect to Sensor to App.....	10
5.3 Configure parameters through App.....	12
5.3.1 Select the Platform and Frequency.....	12
5.3.2 Set the Interval.....	17
5.3.3 Set the EUI and Key.....	17
5.3.4 Set the Packet Policy.....	18
5.3.5 Set the Activation Type.....	18
5.3.6 Restore Factory Setting.....	19
5.3.7 Set 3 temperature channels for S2107.....	20
5.3.8 Set S2108 for measuring different soil types.....	21
6. Connect to the SenseCAP Portal	22
6.1 SenseCAP Portal.....	22
6.1.1 Create a New Account.....	22
6.1.2 Other Functions.....	23
6.1.3 API Instruction.....	23
6.2 Connect to SenseCAP with Helium Network.....	24
6.2.1 Quick Start.....	24
6.2.2 Preparation.....	24
6.2.3 Bind Sensor to SenseCAP Portal.....	25
6.2.4 Setup the Sensor.....	27
6.2.5 Set Frequency of Sensor via SenseCAP Mate App.....	28
6.2.6 Check Data on SenseCAP Portal.....	29
6.3 Connect to SenseCAP with private TTN.....	31
6.3.1 Quick Start.....	31
6.3.2 Preparation.....	31
6.3.3 Bind Sensor to SenseCAP Portal.....	32
6.3.4 Setup the Sensor.....	32
6.3.5 Set Frequency of Sensor via SenseCAP Mate App.....	32
6.3.6 Check Data on SenseCAP Portal.....	33

7. Connect to Helium Network	34
8. Connect to The Things Network	34
9. Payload Decoder	35
9.1 Decoder Code	35
9.2 Packet Parsing	35
9.2.1 Packet Initialization	35
9.3 Data Parsing Example	36
9.3.1 Measurements List	36
9.3.2 Example – S2101 Air Temperature and Humidity Sensor	38
9.3.1 Example – S2102 Light Intensity Sensor	39
9.3.2 Example – S2103 CO2, Temperature and Humidity Sensor	40
9.3.3 Example – S2104 Soil Moisture and Temperature Sensor	41
9.3.4 Example – S2105 Soil Moisture, Temperature and EC Sensor	42
9.3.5 Example – S2106 pH Sensor	43
9.3.6 Example - S2107 Temperature Sensor	44
9.3.7 Example - S2108 Soil Moisture, Temperature and EC Sensor	46
9.4 Battery Information	47
10. LoRaWAN Downlink Command	49
10.1 Set the Data Uplink Interval	49
10.2 Reboot the device	51
10.3 How to send downlink.....	51
11. Error code	52
11.1 Details.....	52
12. Device Installation	53
12.1 The Do's and Don'ts.....	53
12.2 Installing Bracket	54
12.2.1 Installing the Sensor Bracket.....	54
12.2.1 Mount on Pole and Wall	55
12.2.2 Antenna Installation Direction	55
12.3 Installation Considerations for Sensors	56
12.3.1 Install the S2101/S2103	56
12.3.1 Install the S2102	56
12.3.1 Install the S2104/S2105	57
12.4 Replace the Battery	58
12.4.1 How to Buy the Battery	58
12.4.2 How to Replace a New Battery	58
13. Calibration Sensor	61

13.1 S2101/S2103: Temperature and Humidity	61
13.2 S2103: Calibration of CO2	61
13.3 S2104 and S2105: Calibration of Soil Moisture and EC	63
13.4 S2106: Calibration of pH	63
14. Trouble Shooting	66
14.1 Sensors can't join LoRa network, how to do?	66
14.2 Why is the new sensor's battery not 100%?	66
14.3 Battery Life Prediction	66
14.4 Support	66
14.5 Document Version	66



1. Product Introduction



Among the first launch of Seeed Industrial IoT product series, SenseCAP is focusing on wireless environmental sensing applications: smart agriculture, precision farming, smart city and so on. It consists of hardware products (sensors, data-loggers & gateways, etc.), software services (SenseCAP portal, mobile App, open dashboard), and API for device & data management.





The next generation of SenseCAP LoRaWAN sensors, the S210X series offers users' industrial long-distance data acquisition via LoRa. The S210x series is suitable for a wide variety of different industries such as smart agriculture, smart buildings and industrial control.

With the IP66 rating, $-40 \sim +85^{\circ}\text{C}$ operating temperature and built-in 19Ah high-capacity battery, combined with the devices' low power consumption, the S210X series can operate in harsh outdoor environments for up to 10 years with a range of up to 10km. The built-in Bluetooth facilitates setup and greatly reduces large-scale deployment costs. Users can focus on application development with the easy set-up and start retrieving data in a few steps. Just install the device, bind it using the QR code and configure the network, then data can be viewed from the SenseCAP portal, which supports popular IoT protocols such as HTTP and MQTT.

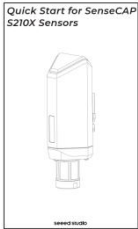

2. Part List

Before installing, please check the part list to ensure nothing is missing.

Picture	Name	Quantity
	Sensor Node	1
	Bracket	1
	Quick Start Guide	1
	KA4*20mm Self-drilling Screw	4



3. Key Parameters of the Sensor

Using the LoRaWAN protocol generally involves the following parameters.

Parameters		Description
LoRaWAN Version	MAC	v1.0.3
Join Type		OTAA (Default) ABP (It can be modified via App)
Device EUI		Unique identification of device, one of the join network parameters on OTAA mode. (It can be got via App)
Device Code (KEY)		On the device label, for device binding and API call.
App EUI		Unique identification of application, one of the join network parameters on OTAA mode. (It can be got via App)
App Key		Application key, one of the join network parameters on OTAA mode. (It can be got via App)
DevAddr		This parameter is available only in ABP mode, one of the join network parameters.
NwkSkey		This parameter is available only in ABP mode, one of the join network parameters.
AppSkey		This parameter is available only in ABP mode, one of the join network parameters.



4. LED of Sensor Working Status

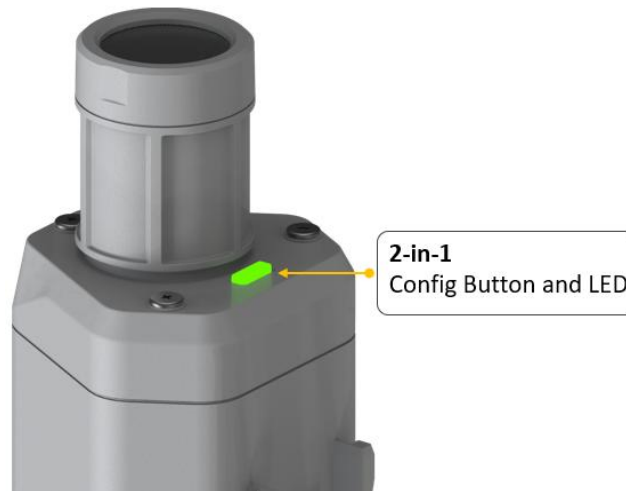

You can refer to the LED indicator for the Sensor Node for its working status. Please see the status explanations in the chart below:

Actions	Description	Green LED Status
First power up, press and hold for 3s	Power on and activate the Bluetooth	LED flashes at 1s frequency, waiting for Bluetooth connection. If Bluetooth not connected within 1 minute, the machine would shut down again.
Press once	Reboot device and join LoRa network	<ol style="list-style-type: none">1. The LED will be on for 5 seconds for initialization2. Waiting for join LoRa network: breathing light flashing3. Join LoRa network success: LED flashes fast for 2s4. LoRa network join failure: LED suddenly stop.



Press and hold for 3s	Activate Bluetooth again	<ol style="list-style-type: none">1. Waiting for Bluetooth connection: LED flashes at 1s frequency2. Enter configuration mode after Bluetooth connection is successful: LED flashes at 2s frequency <p>If Bluetooth is not connected within 1 minute, the device will reboot and join LoRa network.</p>
Press and hold for 9s	Power off	<p>In the 3rd seconds will start flashing at 1s frequency, until the light is steady on, release the button, the light will go out.</p>



Note:

*1. After power off, you need to **reconfigure the frequency band**. Power off is recommended when not deployed.*

2. If the frequency is not configured after power on, the device will be power off again.



5. SenseCAP Mate App

5.1 Download App

As a tool, SenseCAP Mate App is used to config LoRa parameters, set interval, bind devices to your account and check device basic information.

- (1) For iOS, please search for “SenseCAP Mate” in the App Store and download it.



Download SenseCAP Mate App

- (2) For Android, please search for “SenseCAP Mate” in the Google Store and download it.

You can also download App from <https://www.pgyer.com/sensecapmate>

5.2 How to connect sensor to App

5.2.1 Create a New Account

SenseCAP Mate supports device configuration and remote management. To use the SenseCAP Portal platform and other functions, please register an account.

SenseCAP Mate supports offline functionality, and you can opt out of an account if you only use the configuration sensor. Just click Skip.

Please select **Global** of Server Location.

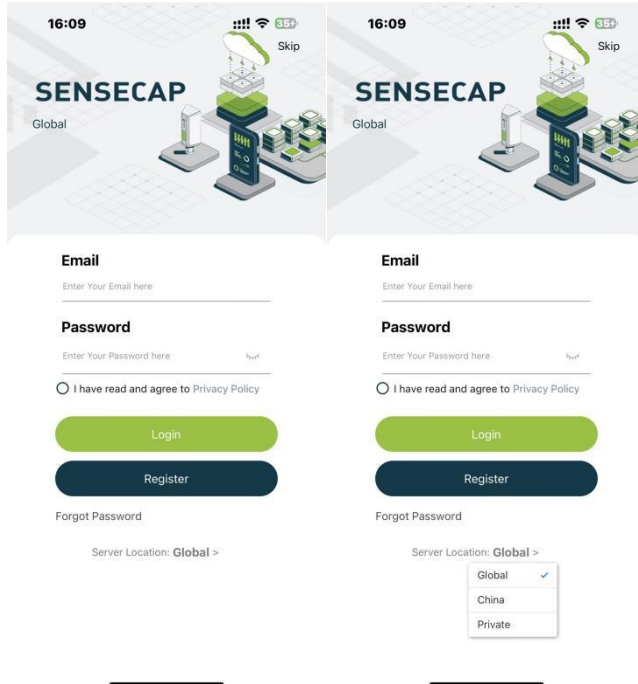

You can also create an account via the SenseCAP Portal: <http://sensecap.seeed.cc>

- 1) Select register account, enter email information and click "register", the registered email will be sent to the user's mailbox.
- 2) Open the "SenseCAP..."Email, click the jump link, fill in the relevant information, and complete the registration.
- 3) Return to the login interface and complete the login.



Note:

If you can't find the email, it may be automatically identified as "spam" and put in the "trash can".

5.2.2 Connect to Sensor to App

- 1) Press button and hold for **3 seconds**, the LED will flash at 1s frequency. Please use the App to connect the sensor within 1 minute; otherwise, the device will power off or reboot.

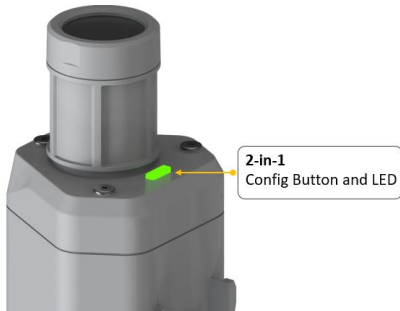

- 2) "User">"Device Bluetooth Configuration". Please select "S210X Sensor", it includes S210X series products.

Please click the "Setup" and "Advanced Configuration" button to turn on Bluetooth and click "Scan" to start scanning the sensor's Bluetooth.

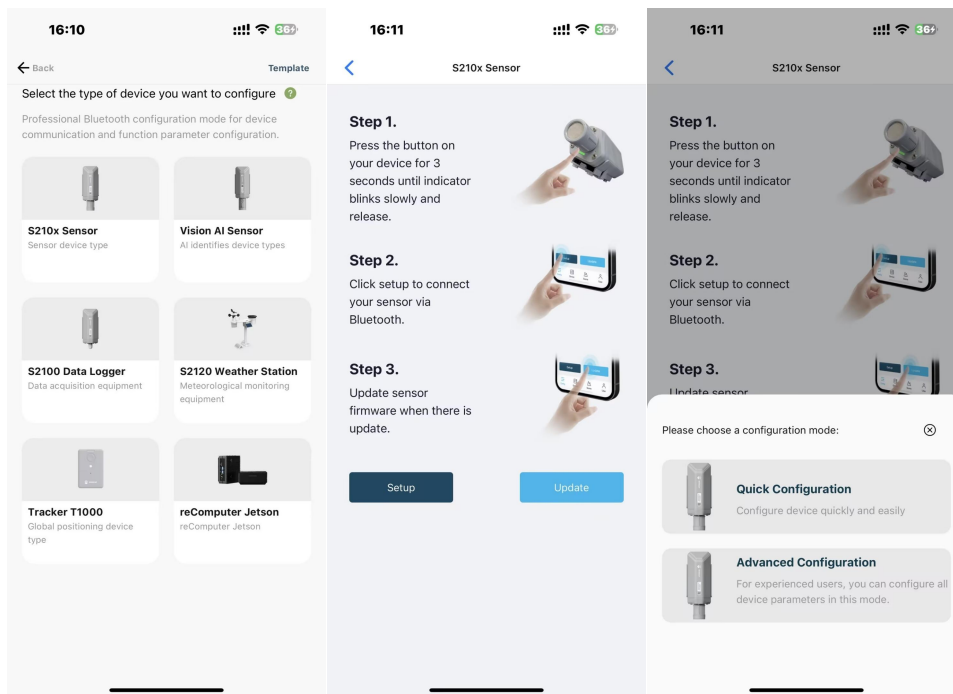

- 3) Select the Sensor by S/N (S/N is on the front label of the sensor). Then, the basic information of the sensor will be displayed after entering.

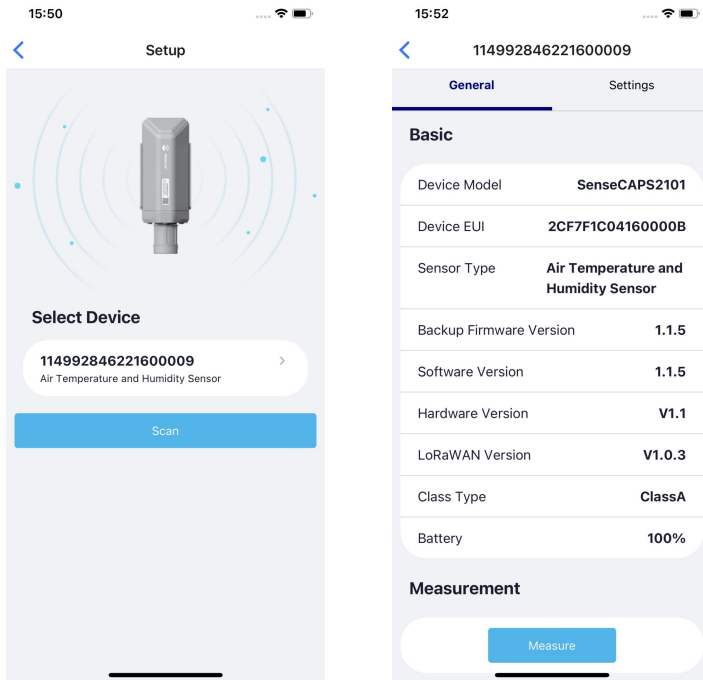

- 4) Enter configuration mode after Bluetooth connection is successful: LED flashes at 2s frequency.

5.3 Configure parameters through App

5.3.1 Select the Platform and Frequency

S210x Sensors are manufactured to support universal frequency plan from 863MHz ~928MHz in one SKU. That is to say, every single device can support 7 frequency plans.

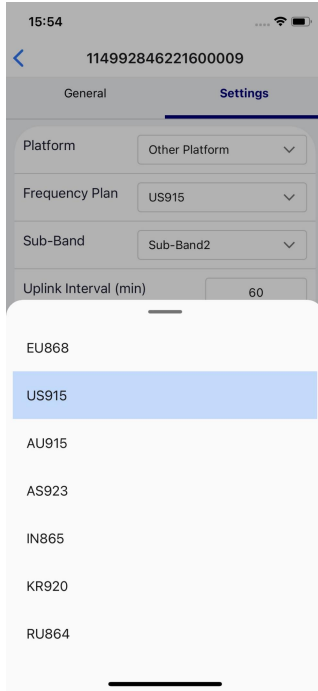
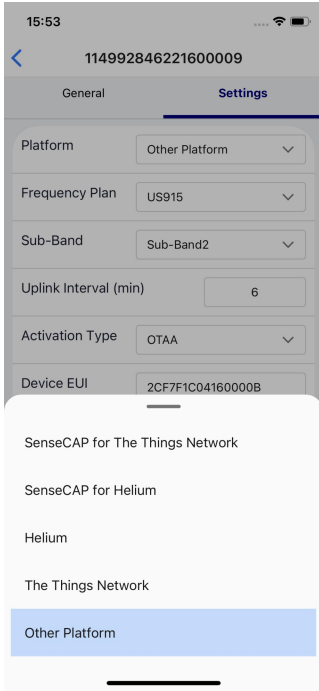

Platform	Description
SenseCAP for The Things Network	Default platform. It must be used with SenseCAP Outdoor Gateway (https://www.seeedstudio.com/LoRaWAN-Gateway-EU868-p-4305.html). SenseCAP builds a proprietary TTN server that enables sensors to be used out of the box when paired with an SenseCAP outdoor gateway.
SenseCAP for Helium	When there is the Helium network around the user, data can be uploaded using sensors. Devices run on a private Helium console of SenseCAP. Users do not need to create devices on Helium console, right out of the box.
Helium	Connect Sensor to public Helium console.
The Things Network	Connect Sensor to your TTN(TTS) server.
Other Platform	Other LoRaWAN Network Server.

1) SenseCAP for Helium:

We provide the SenseCAP Portal to manage devices and data: sensecap.seeed.cc

We built a private Helium Console with an embedded SenseCAP Portal. When users get the SenseCAP sensors, you can use it by scanning the code and binding it to the Portal.

“SenseCAP for Helium” is selected by default. The device runs in a fixed main frequency and sub-band, refer to Helium Frequency Plan (<https://docs.helium.com/lorawan-on-helium/frequency-plans/>). You only need to select the main frequency, such as EU868 and US915.

SenseCAP for Helium supports the following frequency plan:

EU868 / US915 / AU915 / KR920 / IN865 / AS923-1 / AS923-2 / AS923-3 / AS923-4

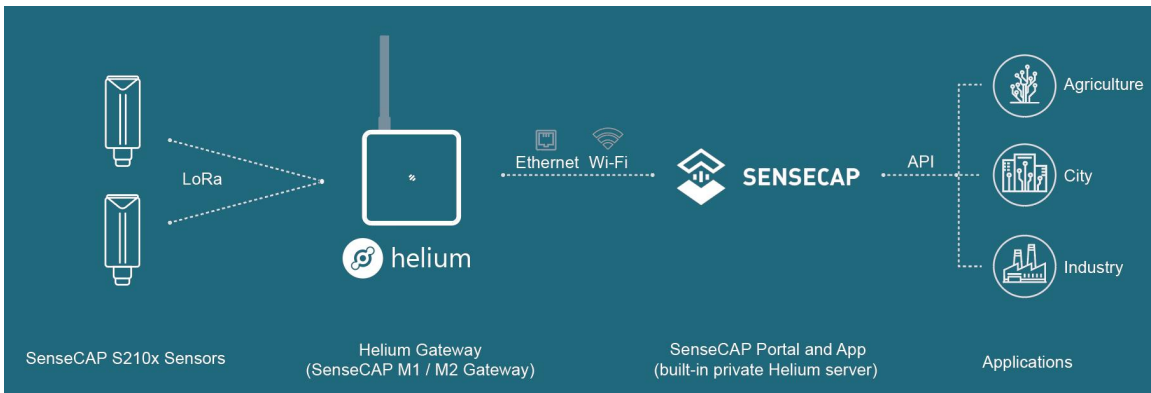

2) SenseCAP for The Things Network

SenseCAP Portal also builds the TTN private server, and the sensor must be used together with the SenseCAP Outdoor Gateway (<https://www.seeedstudio.com/LoRaWAN-Gateway-EU868-p-4305.html>).

Due to the limitation of the SenseCAP outdoor gateway frequency, “SenseCAP for TTN” supports the following frequency plan(The sensor is capable of supporting all frequency plan):

Gateway Frequency	Description
EU868	It must be used with SenseCAP EU868 Gateway (https://www.seeedstudio.com/LoRaWAN-Gateway-EU868-p-4305.html)
US915	It must be used with SenseCAP US915 Gateway (https://www.seeedstudio.com/LoRaWAN-Gateway-US915-p-4306.html)



AU915	Need to contact sales to purchase.
AS923-1	Need to contact sales to purchase.
AS923-2	Need to contact sales to purchase.

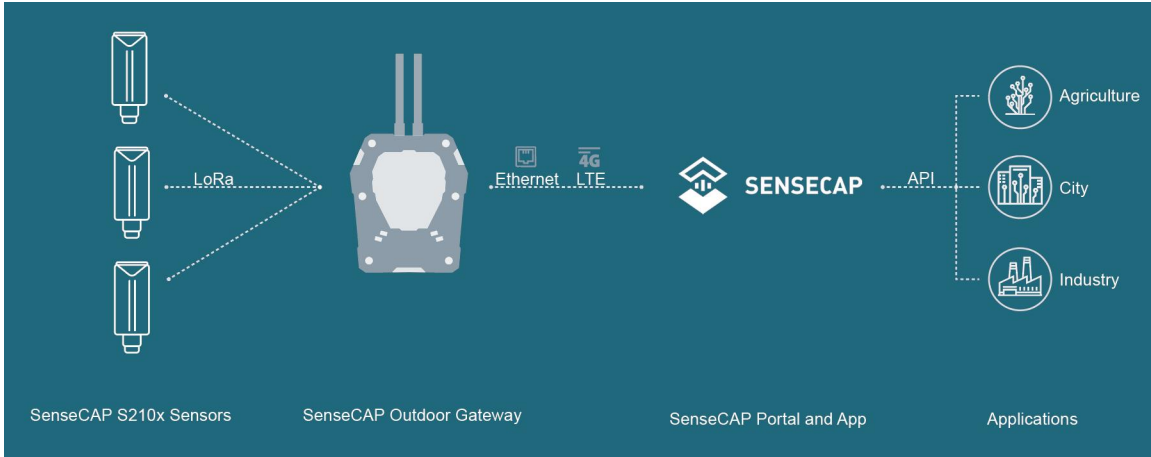

3) Helium

Users can choose sensors to use on the public helium console:

<https://console.helium.com/>

4) The Things Network

Users can choose sensors to use on the public The Things Network server:

<https://console.cloud.thethings.network/>

5) Other Platform:

When you use other LoRaWAN network server, please select Other Platform.

At this point, you need to determine the sensor frequency band according to the gateway frequency and sub-band.

S210x Sensors support the following frequency plan:



Sensor Frequency	Common Name	Sub-band
EU863-870	EU868	-----
US902-928	US915	Sub band from 1 to 8 (default sub-band 2)
AU915-928	AU915	Sub band from 1 to 8 (default sub-band 2)
KR920-923	KR920	-----
IN865-867	IN865	-----
AS923	AS923-1	Frequency plan for Helium
	AS923-2	
	AS923-3	
	AS923-4	
RU864-867	RU864	-----

 **Note1:**

Different countries and LoRa WAN network servers use different frequency plans. For Helium network, please refer to:

<https://docs.helium.com/lorawan-on-helium/frequency-plans>

For The Things Network, please refer to:

<https://www.thethingsnetwork.org/docs/lorawan/frequency-plans/>

 **Note2:**

- 1) *When using the SenseCAP platform, the EUI, APP EUI and APP Key are fixed and are the same as the sensor label.*
 - 2) *When the sensor is selected to be used with a public platform such as Helium or TTN, the EUI will not change, and the sensor **will generate a new fixed App EUI and App Key** for network access.*
-



5.3.2 Set the Interval

The working mode of device: wake up the device every interval and collect measurement values and upload them through LoRa. For example, the device collects and uploads data **every 60 minutes by default**.

Parameter	Type
Uplink Interval	Unit: minutes, number from 1 to 1440.

Uplink Interval (min)	<input type="text" value="60"/>
-----------------------	---------------------------------



Note:

The SenseCAP portal has a limit on uplink interval: minimum interval is 5 minutes.

The interval using the other platforms ranges from 1 to 1440 minutes.

5.3.3 Set the EUI and Key

The device uses OTAA to join the LoRaWAN network by default. So, it can set the device EUI and App EUI.

Parameter	Type
Device EUI	16, hexadecimal from 0 ~ F
App EUI	16, hexadecimal from 0 ~ F
App Key	32, hexadecimal from 0 ~ F

Device EUI	<input type="text" value="2CF7F1C04160000B"/>
APP EUI	<input type="text" value="577D1C6ECDCC3B8D"/>
APP Key	<input type="text" value="466F991B963100CC478..."/>



5.3.4 Set the Packet Policy

The sensor uplink packet strategy has three modes.

Parameter	Description
2C+1N (default)	2C+1N (2 confirm packets and 1 none-confirm) is the best strategy, the mode can minimize the packet loss rate, however the device will consume the most data packet in TTN, or date credits in Helium network.
1C	1C (1 confirm) the device will sleep after get 1 received confirm packet from server.
1N	1N (1 none-confirm) the device only send packet and then start to sleep, no matter the server received the data or not.

5.3.5 Set the Activation Type

The sensor supports two network access modes, OTAA by default.

Parameter	Description
OTAA (default)	Over The Air Activation, it joins the network through Device EUI, App EUI, and App Key.
ABP	Activation By Personalization, it joins the network through DevAddr, NwkSkey, and AppSkey.

When using ABP mode, you need to configure the following information:

Parameter	Description
DevAddr	32, hexadecimal from 0 ~ F
NwkSkey	32, hexadecimal from 0 ~ F



AppSkey	8, hexadecimal from 0 ~ F
---------	---------------------------

Activation Type

Nwk Skey

ⓘ Only hexadecimal numbers of 0-F with a maximum of 32 digits are allowed to be filled in.

APP Skey

ⓘ Only hexadecimal numbers of 0-F with a maximum of 32 digits are allowed to be filled in.

Dev Addr

ⓘ Only hexadecimal numbers of 0-F with a maximum of 8 digits are allowed to be filled in.



Note:

The factory defaults to a fixed value.

5.3.6 Restore Factory Setting

When selecting the SenseCAP platform, you must use the fixed EUI/App EUI/App Key. Therefore, you need to restore the factory Settings before switching back to the SenseCAP platform from other platforms.

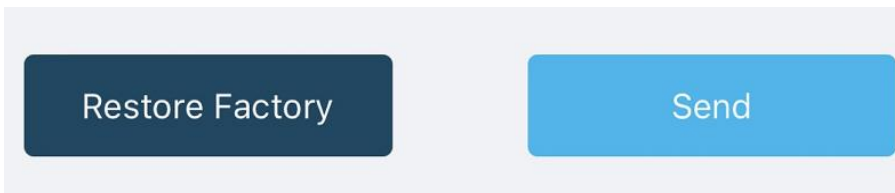

When we make a mistake or want to reset everything, we can click the button. The device will be restored to the factory's default configuration.



5.3.7 Set 3 temperature channels for S2107

Wire 3 PT1000 sensors as shown in the diagram



Use SenseCAP Mate App to set the 3 PT1000 sensors.

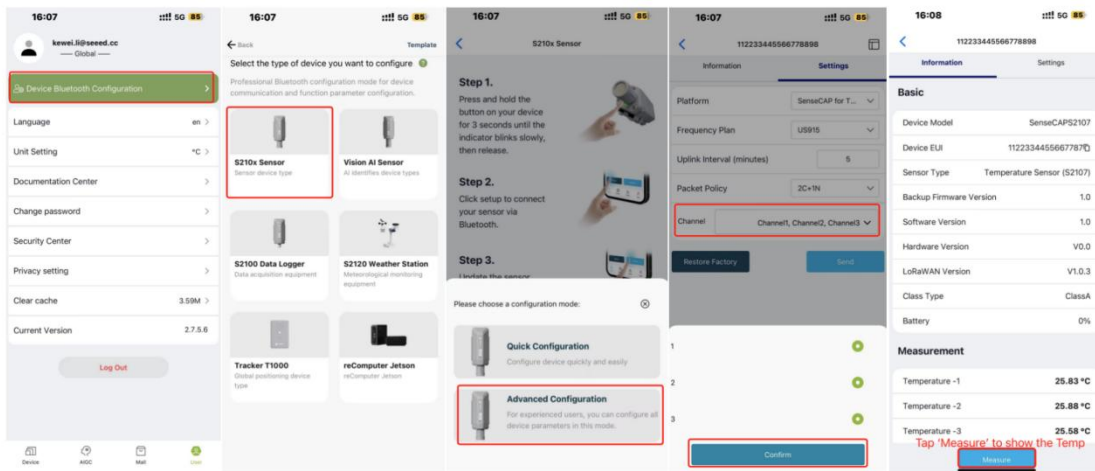

Use SeneCAP Mate App to set 3 PT1000 sensors



5.3.8 Set S2108 for measuring different soil types

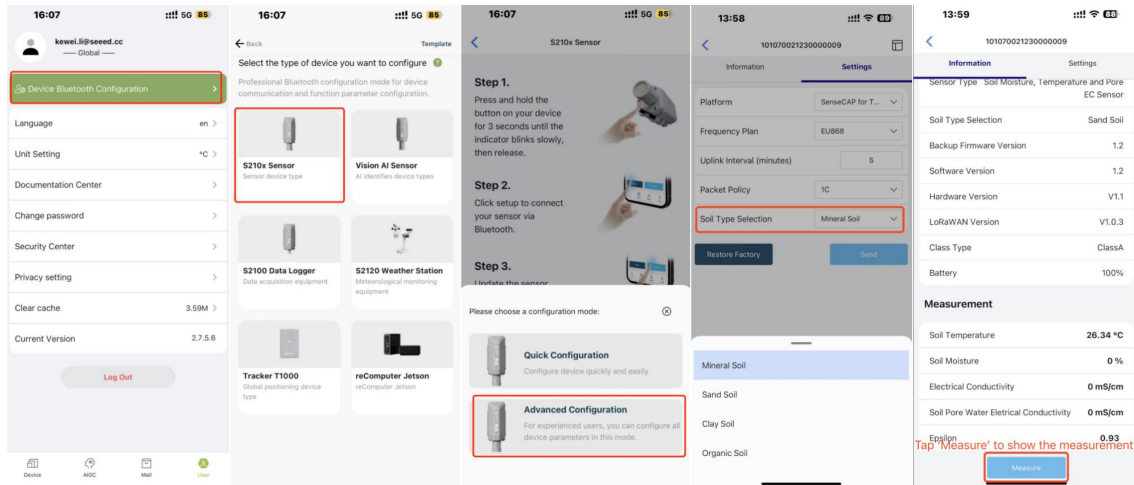

Use SeneCAP Mate App to set modes for measuring different soil types



6. Connect to the SenseCAP Portal

6.1 SenseCAP Portal

The main function of the SenseCAP Portal is to manage SenseCAP devices and to store data. It is built on Azure, a secure and reliable cloud service from Microsoft. You can apply for an account and bind all devices to this account. SenseCAP provides the web portal and API. The web portal includes Dashboard, Device Management, Data Management, and Access Key Management, while API is open to users for further development.

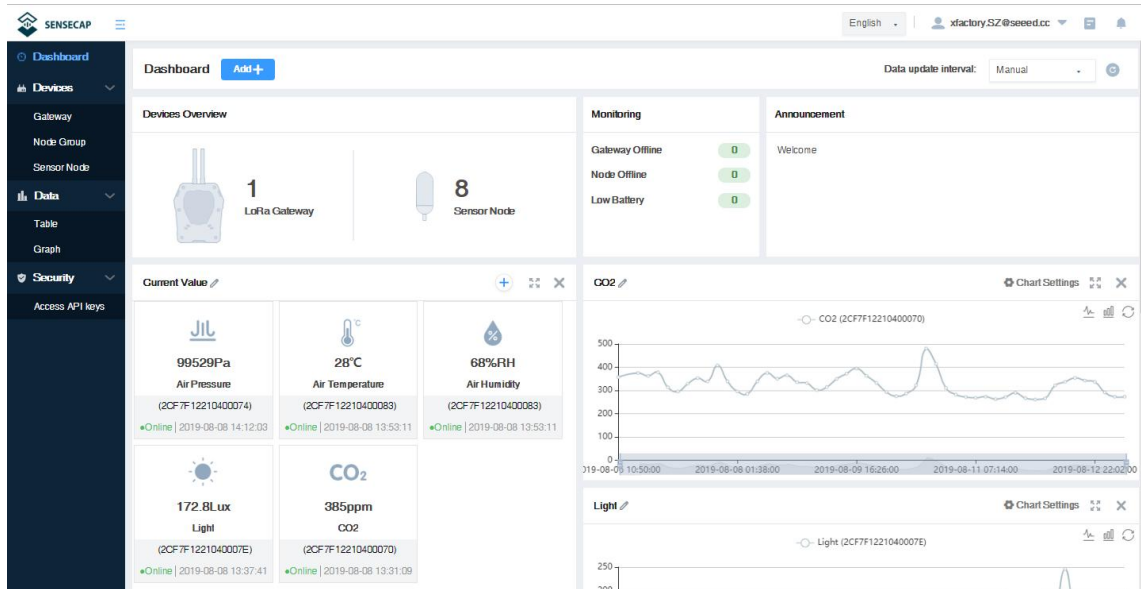

6.1.1 Create a New Account

Portal Website: <http://sensecap.seeed.cc>

- 4) Select register account, enter email information and click "register", the registered email will be sent to the user's mailbox.
- 5) Open the "SenseCAP..."Email, click the jump link, fill in the relevant information, and complete the registration.
- 6) Return to the login interface and complete the login.



Note:

If you can't find the email, it may be automatically identified as "spam" and put in the "trash can".



6.1.2 Other Functions

- **Dashboard:** Including Device Overview, Announcement, Scene Data, and Data Chart, etc.
- **Device Management:** Manage SenseCAP devices.
- **Data Management:** Manage data, including Data Table and Graph section, providing methods to search for data.
- **Subaccount System:** Register subaccounts with different permissions.
- **Access Key Management:** Manage Access Key (to access API service), including Key Create, Key Update, and Key Check.



Note:

SenseCAP Portal User Guide: <https://sensecap-docs.seeed.cc/quickstart.html>

6.1.3 API Instruction

SenseCAP API is for users to manage IoT devices and data. It includes 3 types of API methods: HTTP protocol, MQTT protocol, and Websocket protocol.

- With HTTP API, users can manage LoRa devices, to get raw data or historical data.
- With MQTT API, users can subscribe to the sensor's real-time measurement data through the MQTT protocol.
- With Websocket API, users can get real-time measurement data of sensors through Websocket protocol.

Please refer to this link for API User Guide: <https://sensecap-docs.seeed.cc/>

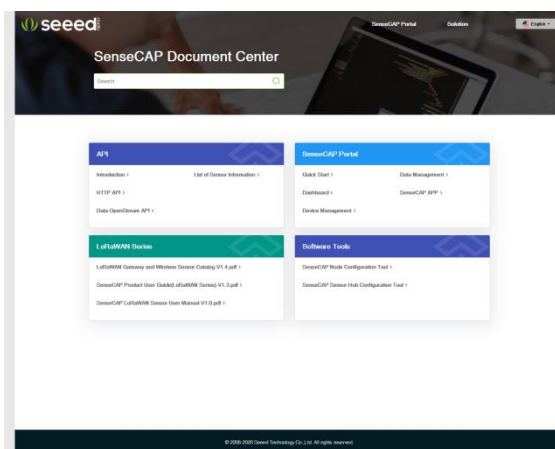



6.2 Connect to SenseCAP with Helium Network

6.2.1 Quick Start

Follow this process to quickly use the sensor, see the following section for details.

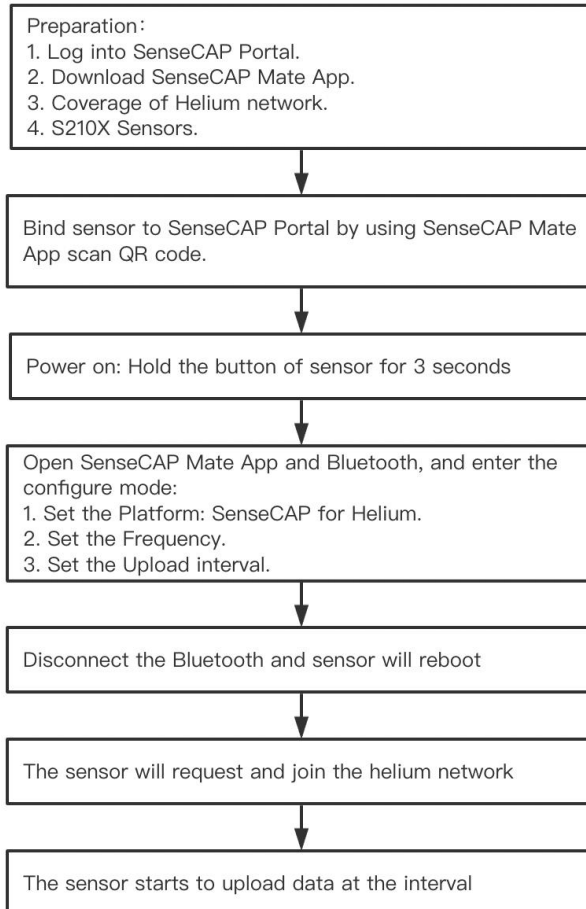

6.2.2 Preparation

1) SenseCAP Mate App

Download the App, please refer to [section 5](#) for using.

2) Coverage of Helium network

Option 1: Use the Helium network that already exists nearby.

Please refer to the map, search your location to see if there's any helium network around: <https://explorer.helium.com/>

A green hexagon indicates the presence of the network.

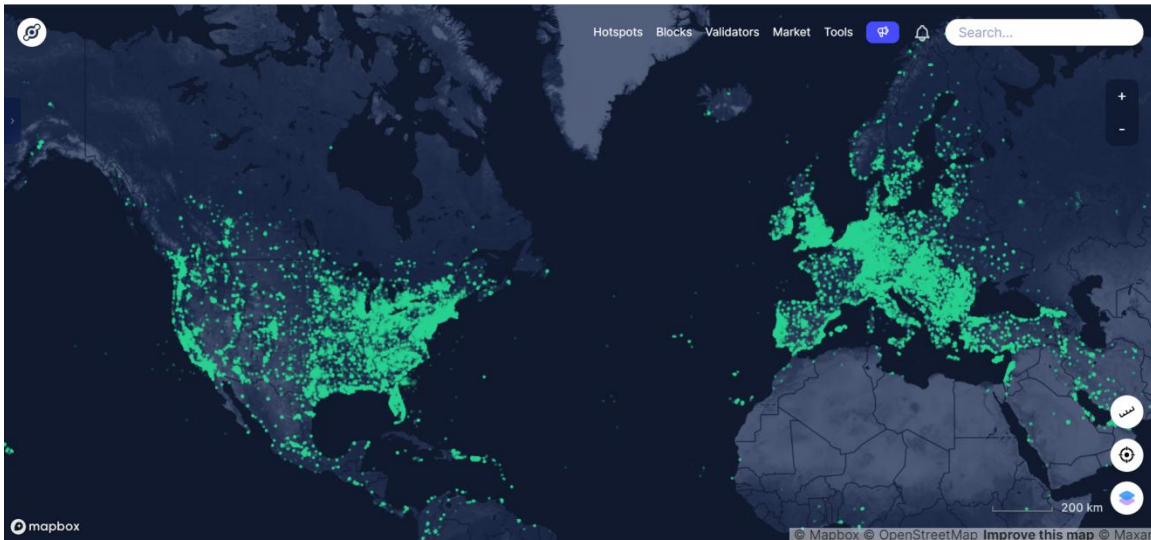

Option 2: Deploy a new Helium gateway.

You can purchase M1, M2 gateways to cover your surroundings with the Helium network: <https://www.sensecapmx.com/>

6.2.3 Bind Sensor to SenseCAP Portal

Please open SenseCAP Mate App.

(1) Scan QR Code

- 1) Click “Add device” on the upper-right corner of device page to enter the device binding page.

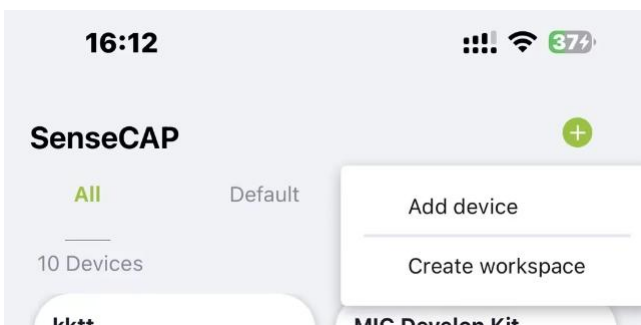

- 2) Scan the QR code on the device to bind the device to your account. If you do not set it to a designated group, the device will be put into the “default” group.

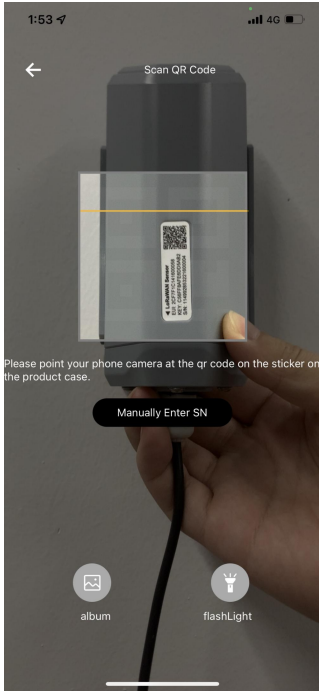

(2) Manually fill in the EUI

If the QR code sticker is damaged, you can manually fill in the EUI of the device to bind the device to your account. Please make sure you put in the EUI in the format suggested by the system and then click “confirm”.

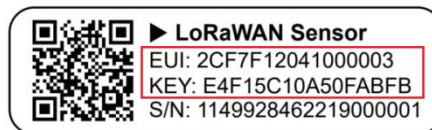



6.2.4 Setup the Sensor

- 1) Open the SenseCAP Mate App
- 2) Press button and hold for **3 seconds**, the LED will flash at 1s frequency.

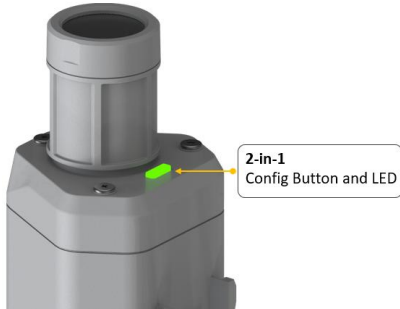

- 3) Please click the “Setup” and “Advanced Configuration” button to turn on Bluetooth and click “Scan” to start scanning the sensor's Bluetooth.

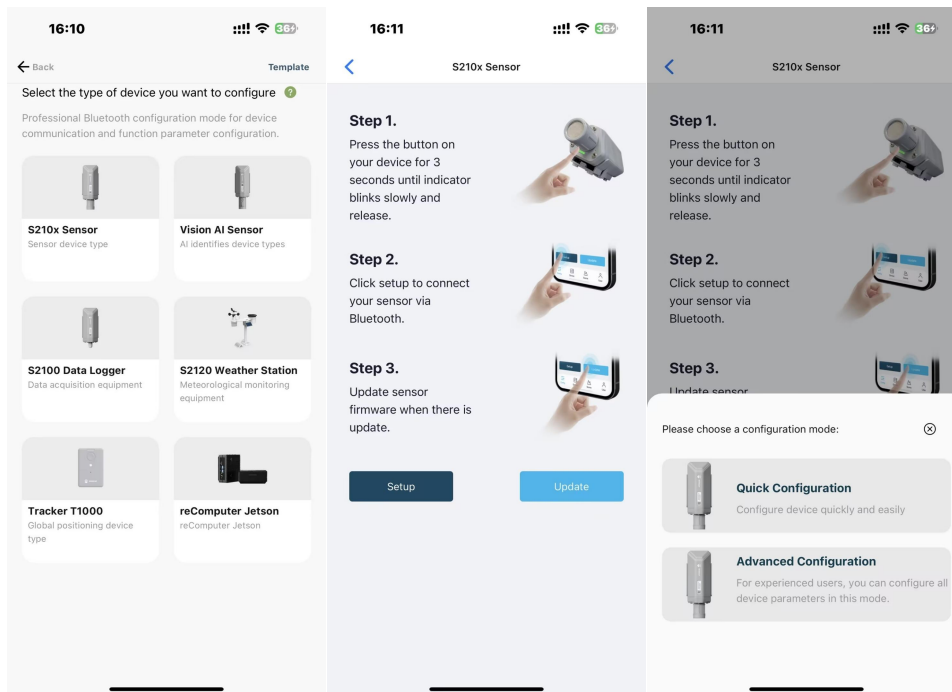

- 4) Select the Sensor by S/N (label). Then, the basic information of the sensor will be displayed after entering.

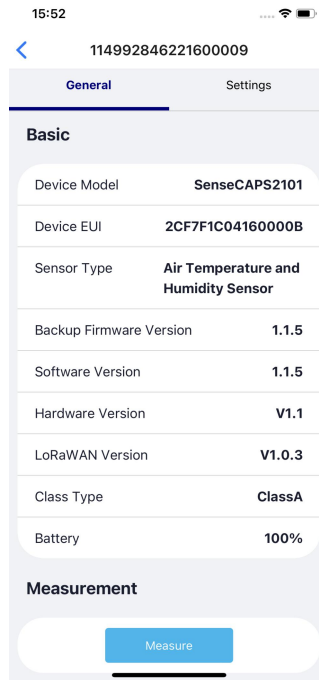
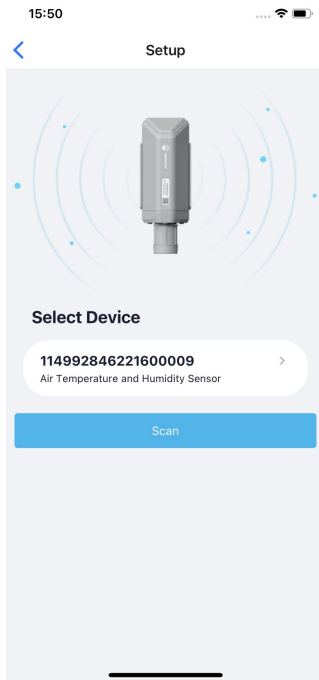

6.2.5 Set Frequency of Sensor via SenseCAP Mate App

Set the corresponding frequency band based on the frequency band of the gateway.

Please refer to [section 5](#) for detail.

- 1) Click the “Setting” and select the platform is “SenseCAP for Helium”.

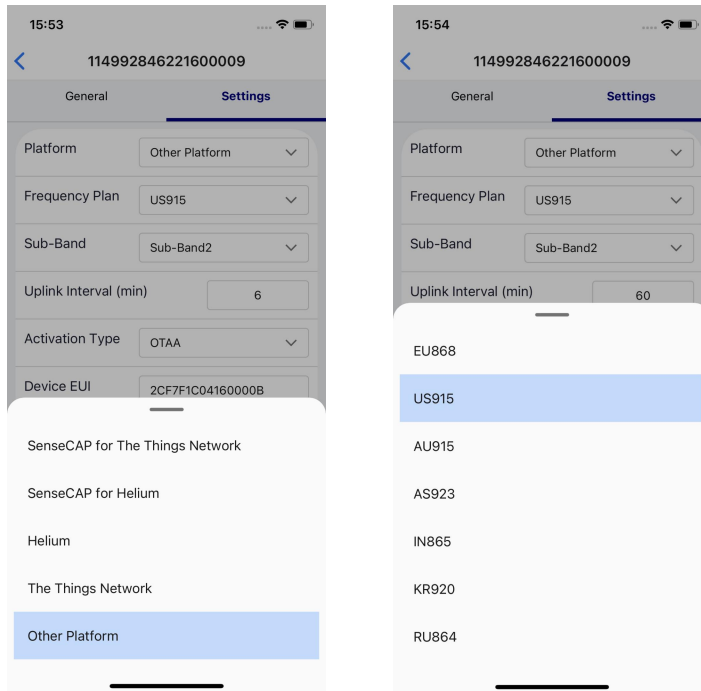

- 2) Select the Frequency Plan, if the gateway is US915, set the sensor to US915.
- 3) Click the “Send” button, send the setting to the sensor for it to take effect.

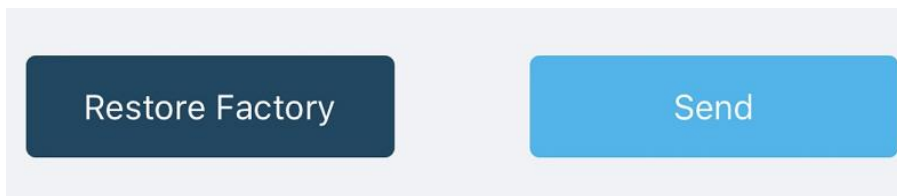

- 4) Click the “Home” button, the App will disconnect the Bluetooth connection.
Then, the sensor will reboot.
- 5) When the device is disconnected from Bluetooth, the LED lights up for **5 seconds** and then flashes as a **breathing light**.
- 6) After joining the network successfully, LED **flashes fast for 2s**.

6.2.6 Check Data on SenseCAP Portal

On the SenseCAP App or the website <http://sensecap.seeed.cc/>, you can check the device online status and the latest data. In the list for each Sensor, you can check its online status and the time of its last data upload.



SENSECAP

English | xfactory.SZ@seed.cc

Dashboard

Devices

- Gateway
- Node Group
- Sensor Node

Data

- Table
- Graph

Security

- Access API keys

Devices / Sensor Node

All | LoRa | NB-IoT

EUI: Device EUI | Frequency(MHz): Frequency

Device Group: Device Group | Online Status: Online Status

Registration Time: From [] To [] | 1Day | 7Days | 30Days

Search | Clear | The number of search results: 4

NO.	EUI	Device Name	Sensor Count	Device Group	Online Status	Operation	Last Message Time
1	2CE7F12210400070	CO2 Sensor	1	station-1	Online	Move	2019-11-15 10:28:16
2	2CE7F12210400074	Barometric Pressure Sensor	1	station-1	Online	Move	2019-11-15 10:09:27
3	2CE7F1221040007E	Light Intensity Sensor	1	station-1	Online	Move	2019-11-15 09:43:47
4	2CE7F12210400083	Air Temperature and Humidity Sensor	1	station-1	Online	Move	2019-11-15 10:02:47



6.3 Connect to SenseCAP with private TTN

6.3.1 Quick Start

Follow this process to quickly use the sensor, see the following section for details.

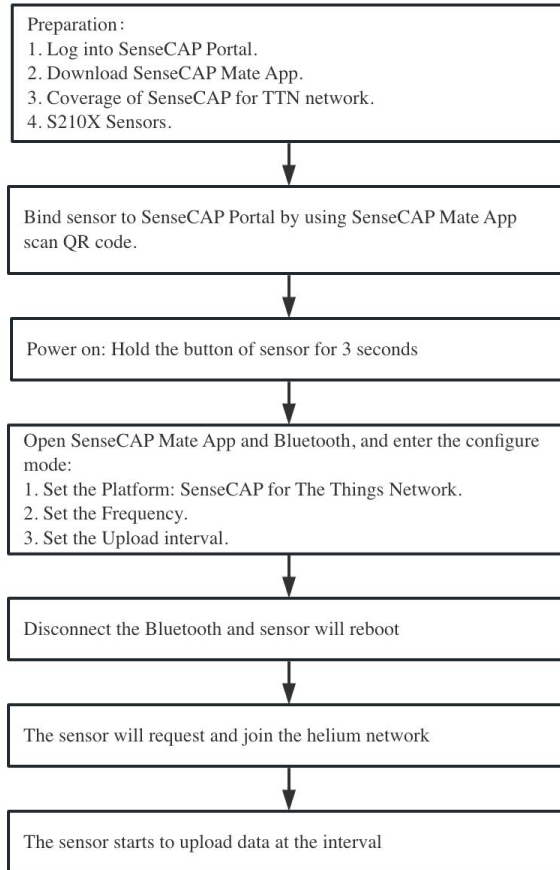

6.3.2 Preparation

1) SenseCAP Mate App

Download the App, please refer to [section 5](#) for using.

2) SenseCAP Outdoor Gateway

Now, the sensor needs to be used with the SenseCAP Outdoor Gateway (<https://www.seeedstudio.com/LoRaWAN-Gateway-EU868-p-4305.html>) to transmit data to the SenseCAP Portal.

- a) Setup the Gateway, connect to power cable and Internet.
- b) Bind the gateway to SenseCAP Portal.
- c) Ensure the gateway indicator is steady on.



d) Ensure the gateway is displayed online on the portal.



6.3.3 Bind Sensor to SenseCAP Portal

Please refer to the [section 6.2.3](#)

6.3.4 Setup the Sensor

Please refer to the [section 6.2.4](#)

6.3.5 Set Frequency of Sensor via SenseCAP Mate App

Set the corresponding frequency band based on the frequency band of the gateway.

Please refer to [section 5](#) for detail.

1) Click the “Setting” and select the platform is “SenseCAP for The Things Network”.

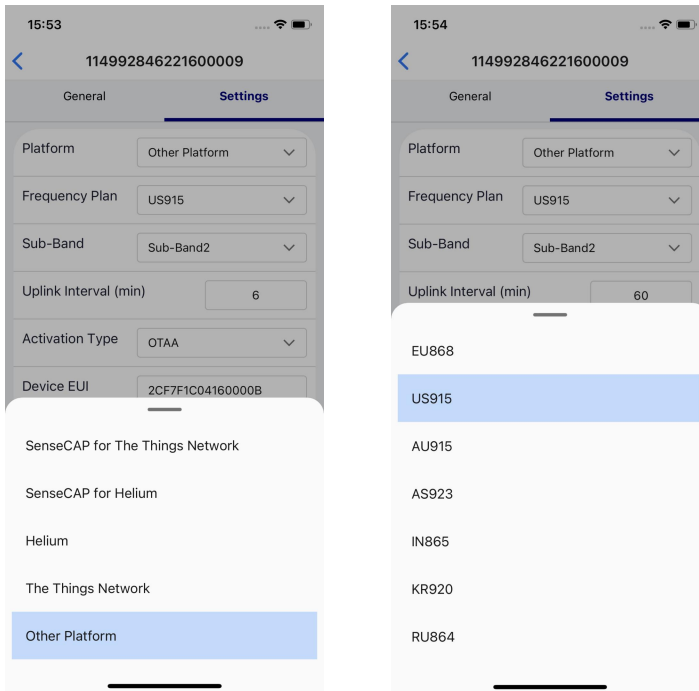

- 2) Select the Frequency Plan, if the gateway is US915, set the sensor to US915.
- 3) Click the “Send” button, send the setting to the sensor for it to take effect.

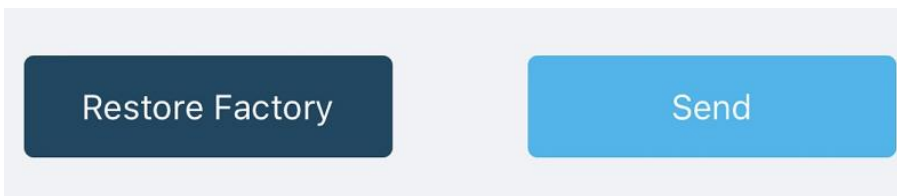

- 4) Click the “Home” button, the App will disconnect the Bluetooth connection.
Then, the sensor will reboot.
- 5) When the device is disconnected from Bluetooth, the LED lights up for **5 seconds** and then flashes as a **breathing light**.
- 6) After joining the network successfully, LED **flashes fast for 2s**.

6.3.6 Check Data on SenseCAP Portal

Please refer to the [section 6.2.6](#)



7. Connect to Helium Network

Please refer to the manual to connect sensors to Helium public console:

<https://files.seeedstudio.com/products/SenseCAP/S210X/How%20to%20Connect%20SenseCAP%20S210X%20to%20Helium%20Network.pdf>

8. Connect to The Things Network

Please refer to this manual:

<https://files.seeedstudio.com/products/SenseCAP/S210X/How%20to%20Connect%20SenseCAP%20S210X%20to%20The%20Things%20Network.pdf>

Please refer to the link to use the TTN platform:

The Things Network website: <https://www.thethingsnetwork.org>

The Things Industries login: <https://accounts.thethingsindustries.com/login>

TTN Quick Start: <https://www.thethingsnetwork.org/docs/quick-start/>



9. Payload Decoder

9.1 Decoder Code

TTN payload decoding script for SenseCAP LoRaWAN:

https://github.com/Seeed-Solution/SenseCAP-Decoder/blob/main/S210X/TTN/SenseCAP_S210X_TTN_Decoder.js

APPLICATION DATA || pause 🗑 clear

Filters: uplink downlink activation ack error

time	counter	port		
11:19:12		0		
11:19:16	5	2	confirmed	payload: 01 01 10 B0 68 00 00 01 02 10 88 F4 00 00 8C FF Measurement Data packets
11:18:36		0		
11:19:02	4	2	confirmed	payload: 00 19 00 58 68 43 00 00 00 AB 5E
11:18:42		0		Initial Packets
11:18:46	3	2	confirmed	payload: 01 06 00 00 00 00 00 2F 87
11:18:28		0		
11:18:32	2	2	confirmed	payload: 00 00 00 01 01 00 01 00 07 00 64 00 05 00 01 01 00 01 01 00 01 01 02 00 54 00 00 15 01 03 00 30
11:18:15		0		
11:18:19	1	2	confirmed	payload: 00 00 00 00 00 00 00 00 00
11:17:57		0		
11:18:01	0	2	confirmed	payload: 00 00 00 00 00 00 00 00 00
11:17:52				dev addr: 26 02 22 C0 app eui: 80 00 00 00 00 00 00 08 dev eui: 2C F7 F1 21 10 70 00 54

Helium Decoder:

https://github.com/Seeed-Solution/SenseCAP-Decoder/blob/main/S210X/Helium/SenseCAP_S210X_Helium_Decoder.js

9.2 Packet Parsing

9.2.1 Packet Initialization

After being powered on or reboot, SenseCAP Sensors will be connected to the network using the OTAA activation method. Each Sensor Node will send data packets to the server, including the following data:

Initial packets (no need to learn about these initial packets)

One packet with device info including hardware version, software version, battery level, sensor hardware & software version, sensor EUI, power, and sensor power time counter at each channel.



Measurement data packets

The only thing we should pay attention to is the sensor measurement data packets.

APPLICATION DATA || pause 🗑️ cle

Filters: uplink downlink activation ack error

time	counter	port	
11:19:12		0	
11:19:16	5	2	confirmed payload: 01 01 10 B0 68 00 00 01 02 10 88 F4 00 00 8C FF Measurement data packets
11:18:58		0	

Packet Structure

The structure of the frame is shown in the image below.

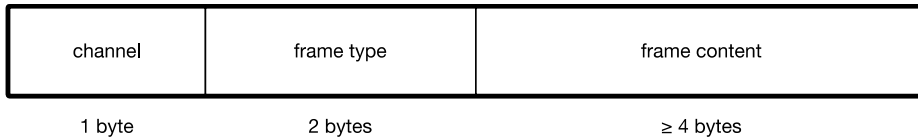

1 byte for channel, default as 1, means the sensor has been well connected.

2 bytes for frame type, in this case, it will be 0110 and 0210, means temperature value and humidity value

4 bytes for content, is the sensor value with CRC

The frame content is sent in **little-endian byte order**.

9.3 Data Parsing Example

9.3.1 Measurements List

Measurements	Measurement ID(HEX/DEC)	Resolution	Unit
Air Temperature	0x1001 / 4097	0.01	°C
Air Humidity	0x1002 / 4098	0.01	%RH
Light Intensity	0x1003 / 4099	1	Lux
CO2	0x1004 / 4100	1	ppm
Soil Temperature	0x1006 / 4102	0.1	°C



Soil Moisture	0x1007	4103	0.1	%
Soil EC (Electrical Conductivity)	0x100C	4108	0.01	dS/m
Soil Pore Water Electrical Conductivity	0x106c	4204	0.01	mS/cm
Epsilon	0x106d	4205		

For the complete list, see: https://sensecap-docs.seeed.cc/measurement_list.html



9.3.2 Example – S2101 Air Temperature and Humidity Sensor

Air Temperature and Humidity Sensor measurement packet:

01 **0110** **B0680000** **01** **0210** **88F40000** **8CFF**

Part	Value	Raw Data	Description
1	Air Temperature	01 0110 B0680000	<p>01 is the channel number.</p> <p>0110 is 0x1001 (little-endian byte order) , which is the measurement ID for air temperature.</p> <p>B0680000 is actually 0x000068B0, whose equivalent decimal value is 26800. Divide it by 1000, and you will get the actual measurement value for air temperature as 26.8°C.</p>
2	Air Humidity	01 0210 88F40000	<p>01 is the channel number.</p> <p>0210 is 0x1002 (little-endian byte order), which is the measurement ID for air humidity.</p> <p>88F40000 is actually 0x0000F488, whose equivalent decimal value is 62600. Divide it by 1000, and you will get the actual value for air humidity as 62.6%RH.</p>
3	CRC	8CFF	The CRC verification part.



9.3.1 Example – S2102 Light Intensity Sensor

Light Intensity Sensor measurement packet:

01 **0310** **A8550200** **E3E9**

Part	Value	Raw Data	Description
1	Light Intensity	01 0310 A8550200	01 is the channel number. 0310 is 0x1003 (little-endian byte order) , which is the measurement ID for Light Intensity. A8550200 is actually 0x000255A8, whose equivalent decimal value is 153000. Divide it by 1000, and you'll get the actual measurement value for Light Intensity as 153 Lux.
3	CRC	E3E9	The CRC verification part.



9.3.2 Example – S2103 CO2, Temperature and Humidity Sensor

CO2, Temperature and Humidity Sensor measurement packet:

01 0410 80140700 01 0110 F4650000 01 0210 7C7D0100 3C4D

Part	Value	Raw Data	Description
1	CO2	01 0410 80140700	<p>01 is the channel number.</p> <p>0410 is 0x1004 (little-endian byte order) , which is the measurement ID for CO2.</p> <p>80140700 is actually 0x00071480, whose equivalent decimal value is 464000. Divide it by 1000, and you will get the actual measurement value for CO2 as 464 ppm.</p>
2	Air Temperature	01 0110 F4650000	<p>01 is the channel number.</p> <p>0110 is 0x1001 (little-endian byte order) , which is the measurement ID for air temperature.</p> <p>F4650000 is actually 0x000065F4, whose equivalent decimal value is 26100. Divide it by 1000, and you will get the actual measurement value for air temperature as 26.1 °C.</p>
3	Air Humidity	01 0210 7C7D0100	<p>01 is the channel number.</p> <p>0210 is 0x1002 (little-endian byte order), which is the measurement ID for air humidity.</p> <p>7C7D0100 is actually 0x00017D7C, whose equivalent decimal value is 97660. Divide it by 1000, and you will get the actual measurement value for air humidity as 97.66 %RH.</p>
4	CRC	3C4D	The CRC verification part.



9.3.3 Example – S2104 Soil Moisture and Temperature Sensor

Soil Moisture and Temperature Sensor measurement packet:

01 0610 245E0000 01 0710 BCB10000 A3D9

Part	Value	Raw Data	Description
1	Soil Temperature	01 0610 245E0000	<p>01 is the channel number.</p> <p>0610 is 0x1006 (little-endian byte order) , which is the measurement ID for soil temperature.</p> <p>245E0000 is actually 0x00005E24, whose equivalent decimal value is 24100. Divide it by 1000, and you will get the actual measurement value for soil temperature as 24.1°C.</p>
2	Soil Moisture	01 0710 BCB10000	<p>01 is the channel number.</p> <p>0710 is 0x1007 (little-endian byte order), which is the measurement ID for soil moisture.</p> <p>BCB10000 is actually 0x0000B1BC, whose equivalent decimal value is 45500. Divide it by 1000, and you will get the actual measurement value for soil moisture as 45.5%RH.</p>
3	CRC	A3D9	The CRC verification part.



9.3.4 Example – S2105 Soil Moisture, Temperature and EC Sensor

Soil Moisture, Temperature and EC Sensor measurement packet:

01 0610 5C5D0000 01 0710 48A30000 01 0C10 B4000000 DD0A

Part	Value	Raw Data	Description
1	Soil Temperature	01 0610 5C5D0000	<p>01 is the channel number.</p> <p>0610 is 0x1006 (little-endian byte order) , which is the measurement ID for soil temperature.</p> <p>5C5D0000 is actually 0x00005D5C, whose equivalent decimal value is 23900. Divide it by 1000, and you will get the actual measurement value for soil temperature as 23.9°C.</p>
2	Soil Moisture	01 0710 48A30000	<p>01 is the channel number.</p> <p>0710 is 0x1007 (little-endian byte order), which is the measurement ID for soil moisture.</p> <p>48A30000 is actually 0x0000A348, whose equivalent decimal value is 41800. Divide it by 1000, and you will get the actual measurement value for soil moisture as 41.8%RH.</p>
3	Soil Electrical Conductivity	01 0C10 B4000000	<p>01 is the channel number.</p> <p>0C10 is 0x100C (little-endian byte order), which is the measurement ID for soil EC.</p> <p>B4000000 is actually 0x000000B4, whose equivalent decimal value is 180. Divide it by 1000, and you will get the actual measurement value for soil EC as 0.18 dS/m.</p>
4	CRC	DD0A	The CRC verification part.



9.3.5 Example – S2106 pH Sensor

pH Sensor measurement packet:

01 0110 72650000 01 0a10 8f1a0000 e191

Part	Value	Raw Data	Description
1	Air Temperature	01 0110 72650000	01 is the channel number. 0110 is 0x1001 (little-endian byte order) , which is the measurement ID for air temperature. 72650000 is actually 0x00006572, whose equivalent decimal value is 25970. Divide it by 1000, and you will get the actual measurement value for temperature as 25.97°C.
2	pH	01 0a10 8f1a0000	01 is the channel number. 0a10 is 0x100A (little-endian byte order), which is the measurement ID for soil moisture. 8f1a0000 is actually 0x00001A8F, whose equivalent decimal value is 6799. Divide it by 1000, and you will get the actual measurement value for pH as 6.799.
3	CRC	e191	The CRC verification part.



9.3.6 Example - S2107 Temperature Sensor

Temperature Sensor measurement packet:

47 09c9 09ec 0a00

Part	Value	Raw Data	Description
1	47	47	47 is the packet ID.
2	Temperature Channel 1	09c9	09c9 is actually 0x09c9, whose equivalent decimal value is 2505. Divide it by 100, and you will get the actual measurement value for temperature as 25.05.
3	Temperature Channel 2	09ec	09ec is actually 0x09ec, whose equivalent decimal value is 2540. Divide it by 100, and you will get the actual measurement value for temperature as 25.40.
4	Temperature Channel 3	0a00	0a00 is actually 0x0a00, whose equivalent decimal value is 2560. Divide it by 100, and you will get the actual measurement value for temperature as 25.60.

Note: If this channel is not opened, 0x8000 will be used.

when offline one packet of data:

7f 0d 46 6526fabf 09c9 09ec 0a00

when offline two packets of data:

7f 18 46 65273c5c 0a18 ec78 ec78 46 65273d8b 0a1d ec78 ec78

when offline three packets of data:

7f 23 46 65265c92 0a3c ec78 ec78 46 65265ee2 0a3d ec78 ec78 46 65266018 0a41 ec78 ec78

Part	Value	Raw Data	Description
1	7f	7f	7f is the packet ID.
2	Total length of package	0d	Total length of package: 0d is actually 0x0d, whose equivalent decimal value is 13.



3	46	46	46 is the packet ID
4	Timestamp	6526fabf	Timestamp: 6526fabf is actually 0x6526fabf, whose equivalent decimal value is 1697053375.
5	Temperature Channel 1	09c9	09c9 is actually 0x09c9, whose equivalent decimal value is 2505. Divide it by 100, and you will get the actual measurement value for temperature as 25.05.
6	Temperature Channel 2	09ec	09ec is actually 0x09ec, whose equivalent decimal value is 2540. Divide it by 100, and you will get the actual measurement value for temperature as 25.40.
7	Temperature Channel 2	0a00	0a00 is actually 0x0a00, whose equivalent decimal value is 2560. Divide it by 100, and you will get the actual measurement value for temperature as 25.60.
...

Battery Information for S2107:

49 5f 01000100 0005

Part	Value	Raw Data	Description
1	Battery	49 5f 01000100 0005	<p>00 is the channel number.</p> <p>5f is actually 0x5f, whose equivalent decimal value is 95. the actual battery value for device is 95%.</p> <p>01000100 is 0x01000100 -> 1.0-1.0 Software Version 1.0 Hardware Version 1.0.</p> <p>0005 is 0x0005 (little-endian byte order) , whose equivalent decimal value is 5. Upload interval is 5 minutes.</p>



9.3.7 Example - S2108 Soil Moisture, Temperature and EC Sensor

Soil Moisture, Temperature and Pore EC Sensor measurement packet:

01 0610 7a670000 01 0710 48a30000 01 0c10 64000000 01 6d10 9e480000 01 6c10 6c020000 1c12

Part	Value	Raw Data	Description
1	Soil Temperature	01 0610 7a670000	<p>01 is the channel number.</p> <p>0610 is 0x1006 (little-endian byte order) , which is the measurement ID for soil temperature.</p> <p>7a670000 is actually 0x0000677a, whose equivalent decimal value is 26490. Divide it by 1000, and you will get the actual measurement value for soil temperature as 26.49°C.</p>
2	Soil Moisture	01 0710 48a30000	<p>01 is the channel number.</p> <p>0710 is 0x1007 (little-endian byte order), which is the measurement ID for soil moisture.</p> <p>48a30000 is actually 0x0000a348, whose equivalent decimal value is 41800. Divide it by 1000, and you will get the actual measurement value for soil moisture as 41.8%RH.</p>
3	Soil Electrical Conductivity	01 0c10 64000000	<p>01 is the channel number.</p> <p>0c10 is 0x100c (little-endian byte order), which is the measurement ID for soil EC.</p> <p>64000000 is actually 0x00000064, whose equivalent decimal value is 100. Divide it by 1000, and you will get the actual measurement value for soil EC as 0.10 dS/m.</p>
4	Epsilon	01 6d10 9e480000	<p>01 is the channel number.</p> <p>6d10 is 0x106d (little-endian byte order), which is the measurement ID for Epsilon.</p> <p>9e480000 is actually 0x0000489e, whose equivalent decimal value is 18590. Divide it by 1000, and you will</p>



			get the actual measurement value for Epsilon as 18.59.
5	Soil Pore Water Electrical Conductivity	01 6c10 6c020000	01 is the channel number. 6c10 is 0x106c (little-endian byte order), which is the measurement ID for Soil Pore Water EC. 6c020000 is actually 0x0000026c, whose equivalent decimal value is 620. Divide it by 1000, and you will get the actual measurement value for soil pore EC as 0.62 mS/cm.
6	CRC	1c12	The CRC verification part.

9.4 Battery Information

Please note the counter number. After 20 packets, it will follow one special packet with battery info.

You can either ignore this packet or get rid of the battery info in your code.

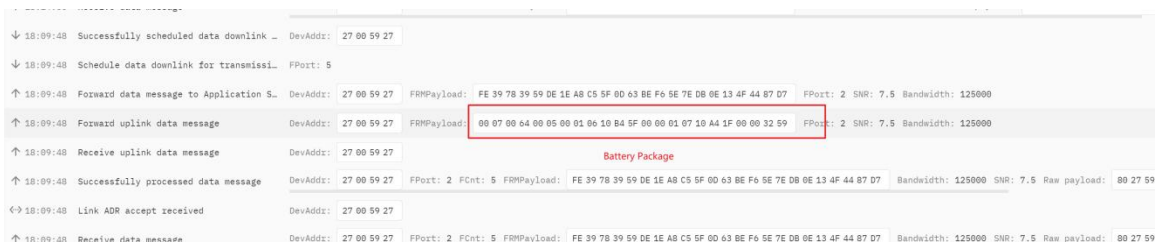

Original Info:

00070064000500010610B45F0000010710A41F00003259

Battery Package: 00070064000500

Example:

Battery & Soil Moisture and Temperature Sensor(S2104) measurement packet:

00070064000500010610B45F0000010710A41F00003259

Part	Value	Raw Data	Description
1	Battery	00 0700 6400 0500	00 is the channel number.



			<p>0700 is 0x0007 (little-endian byte order) , which is the measurement ID for battery.</p> <p>6400 is 0x0064 (little-endian byte order) , whose equivalent decimal value is 100. Battery level is 100%.</p> <p>0500 is 0x0005 (little-endian byte order) , whose equivalent decimal value is 5. Upload interval is 5 minutes.</p>
2	Soil Temperature	01 0610 B45F0000	<p>01 is the channel number.</p> <p>0610 is 0x1006 (little-endian byte order) , which is the measurement ID for soil temperature.</p> <p>B45F0000 is actually 0x00005FB4, whose equivalent decimal value is 24500. Divide it by 1000, and you will get the actual measurement value for soil temperature as 24.5°C.</p>
3	Soil Moisture	01 0710 A41F0000	<p>01 is the channel number.</p> <p>0710 is 0x1007 (little-endian byte order), which is the measurement ID for soil moisture.</p> <p>A41F0000 is actually 0x00001FA4, whose equivalent decimal value is 8100. Divide it by 1000, and you will get the actual measurement value for soil moisture as 8.1%RH.</p>
4	CRC	3259	The CRC verification part.



10. LoRaWAN Downlink Command

10.1 Set the Data Uplink Interval

- (1) Using the Network Server's portal or API to send downlink command, then the Node will respond to the ack. The downlink command takes effect and responds the next time the node uploads data.
- (2) Downlink as follow:

0x00	0x89	0x00	prepareId_L	prepareId_H	duty_L	duty_H	crc-L	crc-H
------	------	------	-------------	-------------	--------	--------	-------	-------

0x00	Fixed field
0x89	Fixed field
0x00	Fixed field
prepareId_L	Command ID low byte, you can customize the values, it allows each command ID to be the same
prepareId_H	Command ID high byte, you can customize the values, it allows each command ID to be the same
duty_L	Data interval low byte, you can set the data interval, unit: minute
duty_H	Data interval high byte, you can set the data interval, unit: minute
crc-L	CRC low byte, it's calculated by the CRC-16/CCITT
crc-H	CRC low byte, it's calculated by the CRC-16/CCITT

- (3) When you send the downlink command, the Node responds to the ack command.

0x00	0x1F	0x00	prepareId_L	prepareId_H	result	0x00	crc-L	crc-H
------	------	------	-------------	-------------	--------	------	-------	-------

0x00	Fixed field
0x1F	Fixed field
0x00	Fixed field
prepareId_L	Command ID low byte, it is the same as the downlink command
prepareId_H	Command ID high byte, it is the same as the downlink command
result	If the downlink command is in force, it responds 0x01, else it responds 0x00
0x00	Fixed field
crc-L	CRC low byte, it's calculated by the CRC-16/KERMIT
crc-H	CRC low byte, it's calculated by the CRC-16/ KERMIT

- (3) Use the FPort = 2

CRC Tool: <https://crccalc.com/> , select the algorithm of CRC-16/KERMIT.



Example: Set the Node's data interval is 10 minutes.

Send the downlink command (HEX) via **FPort=2**:

00 89 00 11 22 0A 00 38 B4

0x00	0x89	0x00	prepareId_L	prepareId_H	duty_L	duty_H	crc-L	crc-H
00	89	00	11	22	0A	00	38	B4

ACK Response:

00 1F 00 11 22 01 00 78 0F

0x00	0x1F	0x00	prepareId_L	prepareId_H	result	0x00	crc-L	crc-H
00	1F	00	11	22	01	00	78	0F

Command List:

Description	Command
Set Uplink interval = 1 minute	008900112201009050
Set Uplink interval = 5 minutes	00890011220500F037
Set Uplink interval = 10 minutes	00890011220A0038B4
Set Uplink interval = 15 minutes	00890011220F0080CA
Set Uplink interval = 20 minutes	00890011221400B9BB
Set Uplink interval = 30 minutes	00890011221E00C946
Set Uplink interval = 60 minutes	00890011223C004A56



10.2 Reboot the device

FPort = 2

Command: `00C800000000002B26`

10.3 How to send downlink

Example: use the Helium Console to send

The screenshot shows the 'Add Downlink Payload' interface in the Helium Console. It features several input fields and options:

- Scheduling:** Two buttons, 'First' and 'Last', with 'Last' selected.
- FPort:** A text input field containing the value '2'.
- Region:** A dropdown menu showing 'US915'.
- Payload:** A text input field containing the hex string '00890011220500F037'.
- Encoding:** Two buttons, 'Base64' and 'Text', with 'Text' selected.
- Confirmation:** A checked checkbox labeled 'I'd like confirmation of response'.
- Submit:** A blue circular button with a right-pointing arrow icon in the bottom right corner.



11. Error code

11.1 Details

If you're experiencing these error code, you could contact us for debugging:

sensecap@seeed.cc

Type	Error code(Dec)
SENSOR_NOT_RESPONSE	2000001
SENSOR_DATA_HEAD_ERROR	2000002
SENSOR_ARG_INVAILD	2000003
SENSOR_DATA_ERROR_UNKONW	2000257

Example:

2023-06-01 15:55:01	2023-06-01 15:55:01	010610e8973577010710e89735773901
2023-06-01 15:49:57	2023-06-01 15:49:57	010610e8973577010710e89735773901
2023-06-01 15:45:05	2023-06-01 15:45:05	010610e8973577010710e89735773901
2023-06-01 15:44:59	2023-06-01 15:44:59	000000301000100020013002045000300

Raw data **E8973577** is actually 0x773597E8, whose equivalent decimal value is 2000001000. Divide it by 1000, and you will get the actual error code **2000001**.



12. Device Installation

12.1 The Do's and Don'ts

1. Do not remove the sensor probe. Otherwise, it will cause leaks and wire fracture. If accidentally unscrewed, it needs to be tightened to ensure waterproof performance. (like the ①②)



2. Do not open the inside of the sensor unless the battery needs to be replaced. This may result in abnormal waterproofing. If it is opened, make sure the waterproofing gasket is properly installed and tighten the screws.

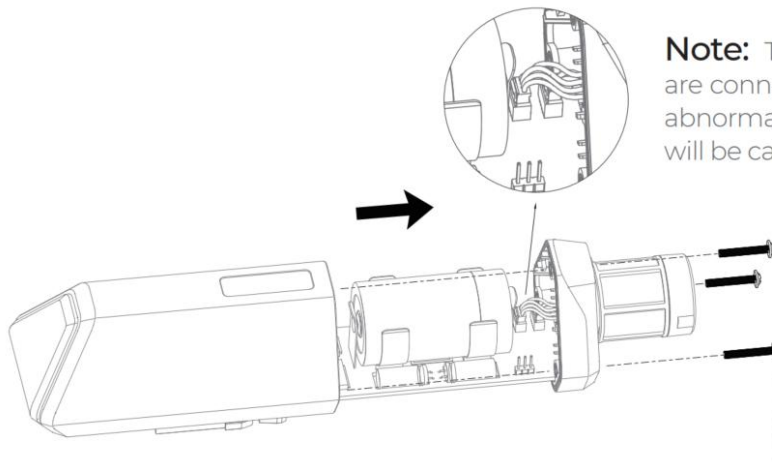

Note: The sensor and PCBA are connected by wire, and the abnormal contact of the sensor will be caused by strong pull.



12.2 Installing Bracket

12.2.1 Installing the Sensor Bracket

Specially designed for installing SenseCAP Sensors, the bracket is a sliding cap. With designated screw-holes, the bracket helps fasten the Sensor Node firmly onto a pole or a wall.

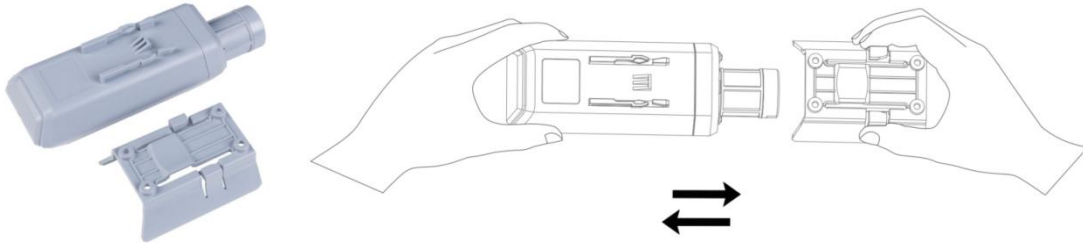

- 1) With the sensor in one hand and a bracket in the other, find an unobstructed direction along the back of the sensor.
- 2) One hand holds the clasp while the other holds the device. Pull outward with opposite force. Press the upper part of the buckle with your finger.

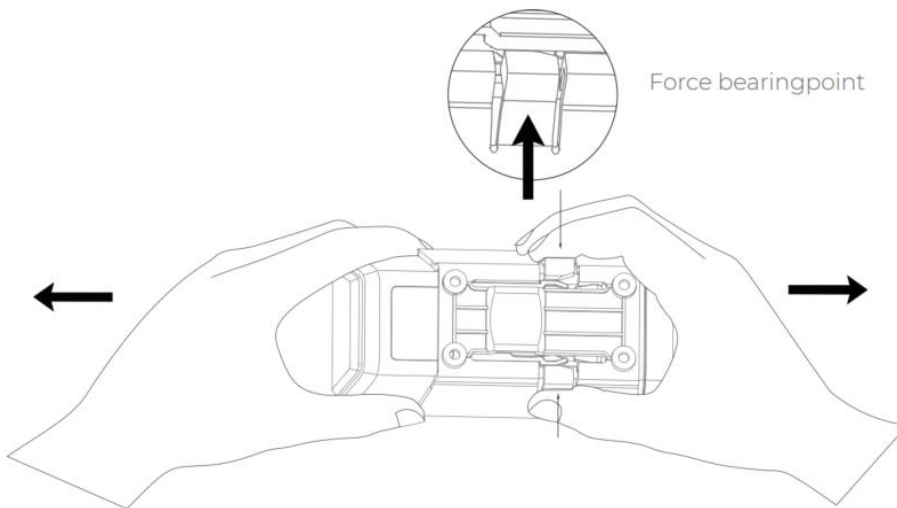



12.2.1 Mount on Pole and Wall

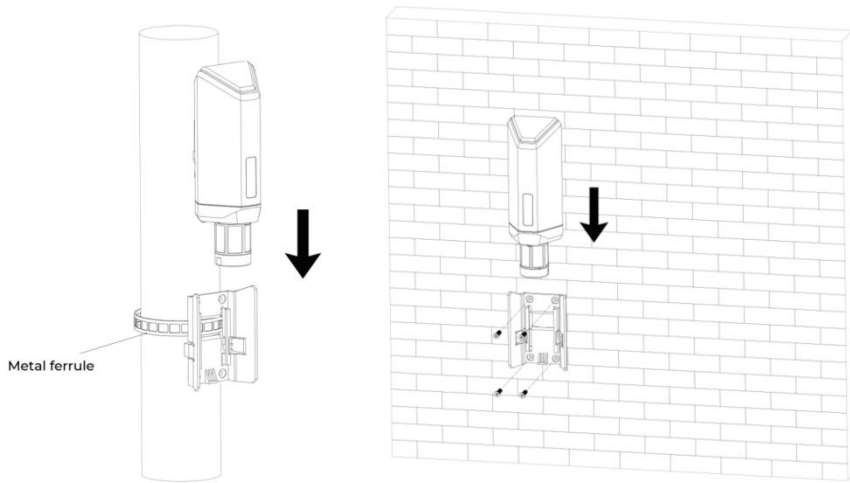

12.2.2 Antenna Installation Direction

When installing, pay attention to the antenna installation direction for better signal strength and longer communication range between sensor and gateway.

Aim the antenna towards the gateway and install both sensor and gateway at higher elevations to reduce obstructions in line of sight between them. This will result in stronger signal strength.

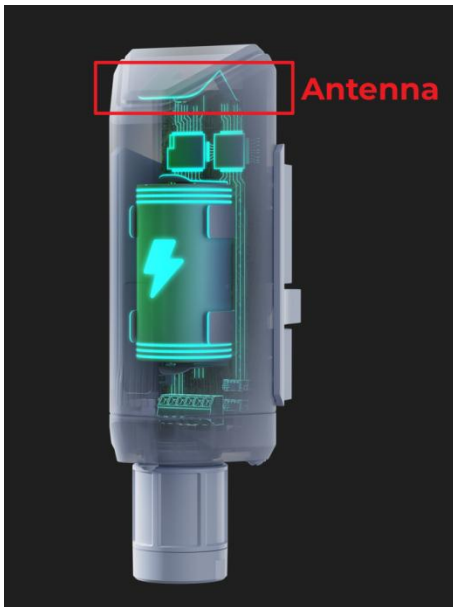



12.3 Installation Considerations for Sensors

12.3.1 Install the S2101/S2103

Temperature and humidity sensors are generally installed on walls or pillars with the probe facing downwards.



If the device is installed outdoors, it is important to avoid direct sunlight as it can cause thermal effects and result in higher temperature readings. To ensure more accurate measurements:

- 1) Install the device in an area that cannot be directly exposed to sunlight.
- 2) Use shades or shields to block out sunlight.



12.3.1 Install the S2102

The light sensor should be oriented towards the light source as much as possible, and if installed outdoors, it should face upwards.



Note that:

- 1) There should be no obstructions above or in front of the sensor facing the light source.
- 2) Orienting the probe directly towards the light source during installation can improve accuracy.

12.3.1 Install the S2104/S2105

Soil sensors need to be installed into the soil and ensure good contact between the sensor and soil. The measurement range for soil probes is a cuboid with dimensions of 7cm x 7cm x 7cm.



- 1) Select a soil monitoring site and dig a pit with a monitoring depth of 15cm or above.
- 2) Insert the probe horizontally or vertically into the soil, taking care to avoid hard rocks.
- 3) Mix some pure water with excavated soil, stir well, and fill the hole around the sensor with mud to ensure full contact between the sensor and soil.



12.4 Replace the Battery

12.4.1 How to Buy the Battery

We suggest buying it from Amazon.

- 1) EEMB ER34615: [Click here](#)
- 2) Search the key word: Li-SOCI2 ER34615 battery. Compare the batteries that meet the following parameters. The most important thing is to match the voltage.

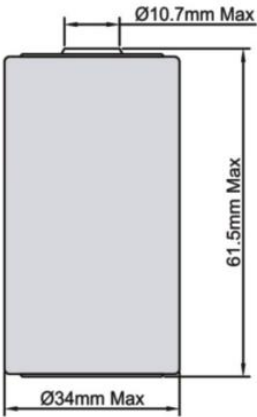
Battery Specification	
Nominal capacity	19000mAh
Model	Li-SOCI2, ER34615
Nominal voltage	3.6V
Max. continuous current	230mA
Max. pulse current capability	400mA
Dimension	<p>∅ 34.0*61.5mm (D size)</p> 
Operating temperature range	-60°C to 85°C

12.4.2 How to Replace a New Battery

- 1) Remove three screws.



Note:



The sensor and PCBA are connected by wire, please disassemble carefully.

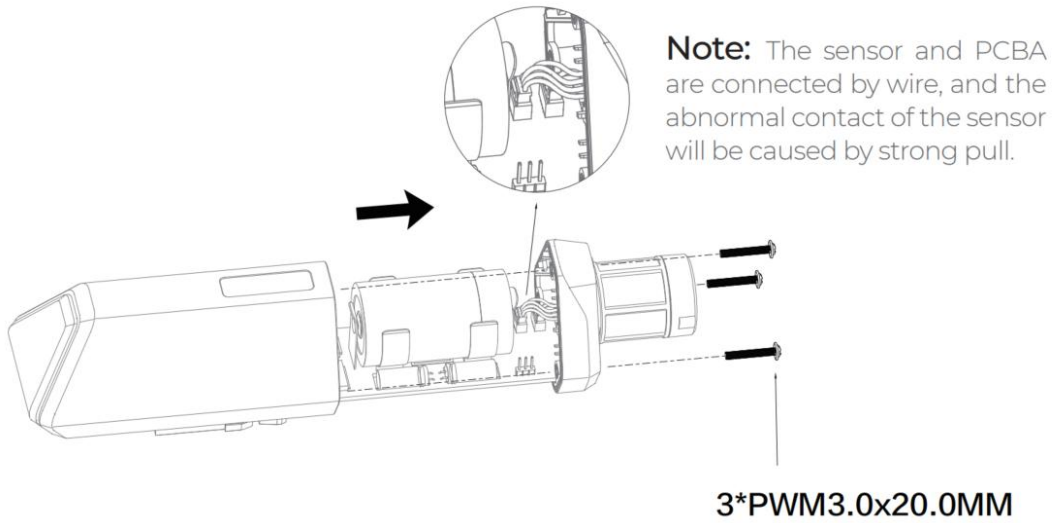

2) Install a new battery.



Note:

Pay attention to the positive and negative terminals of the battery.

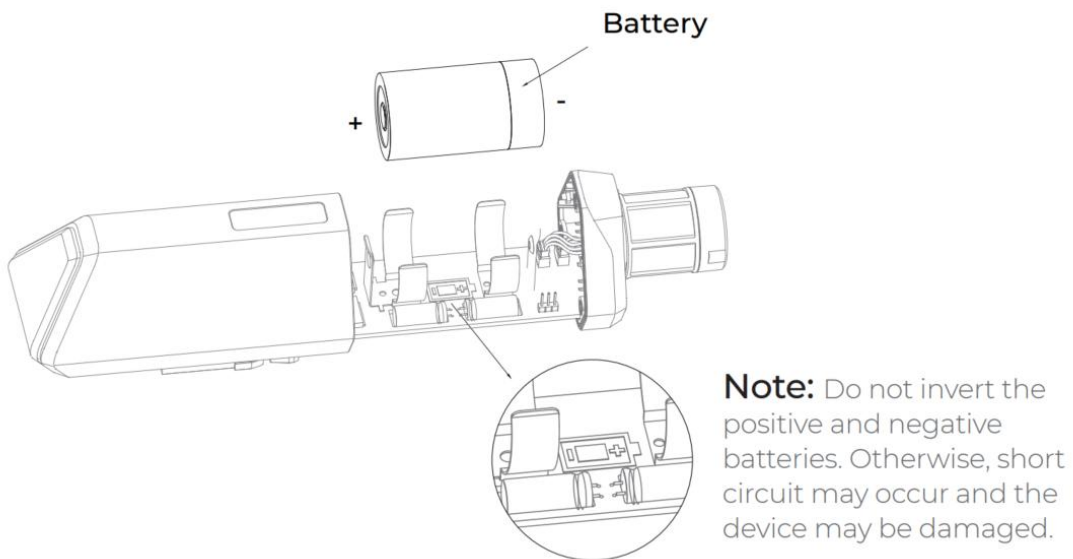

3) Install screws.

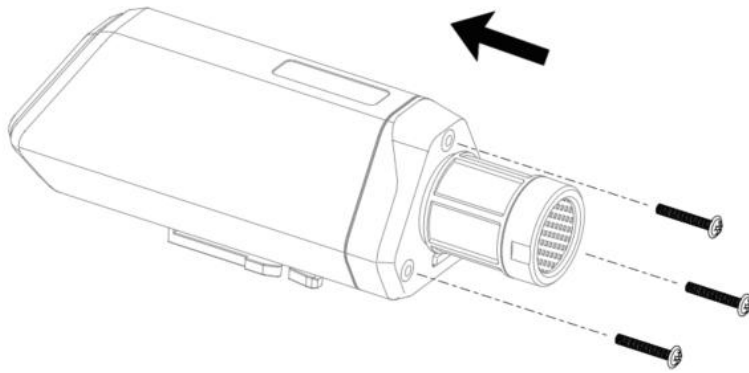

Note:

During the installation, ensure that the waterproof washer is properly installed and the screws are locked; otherwise, water will flow into the device.



13. Calibration Sensor

13.1 S2101/S2103: Temperature and Humidity

The sensor uses high-precision chips and complex accuracy compensation algorithms, so annual drift is very small. In most cases, users do not need to calibrate the sensor.

Long-term drift: typ. value $<0.03\text{ }^{\circ}\text{C}/\text{y}$, Max. value is $<0.04\text{ }^{\circ}\text{C}/\text{y}$

13.2 S2103: Calibration of CO₂

The CO₂ sensor is calibrated using single-point calibration. Place the S2103 in standard gas or near a standard instrument and use the app to input the current CO₂ concentration value from your environment into the sensor, completing calibration.

If standard gas or an instrument is not available, place the sensor outdoors in a ventilated area. The outdoor CO₂ concentration is generally considered to be 400ppm. Let the sensor sit for 5-10 minutes and use the app to input this value into the sensor as calibration.



Note:

- To avoid invalid calibration caused by sudden changes in CO₂ levels due to exhalation from nearby people, ensure that no one is exhaling near the sensor during calibration.*
 - CO₂ has a small annual drift, and calibration is generally recommended every 1-2 years. Depending on the specific usage scenario, it may be necessary to calibrate more or less frequently.*
-

- 1) Place the S2103 sensor in an environment with a known CO₂ concentration and let it sit for 5-10 minutes.
- 2) Use the app to connect to Bluetooth and open the configuration page.

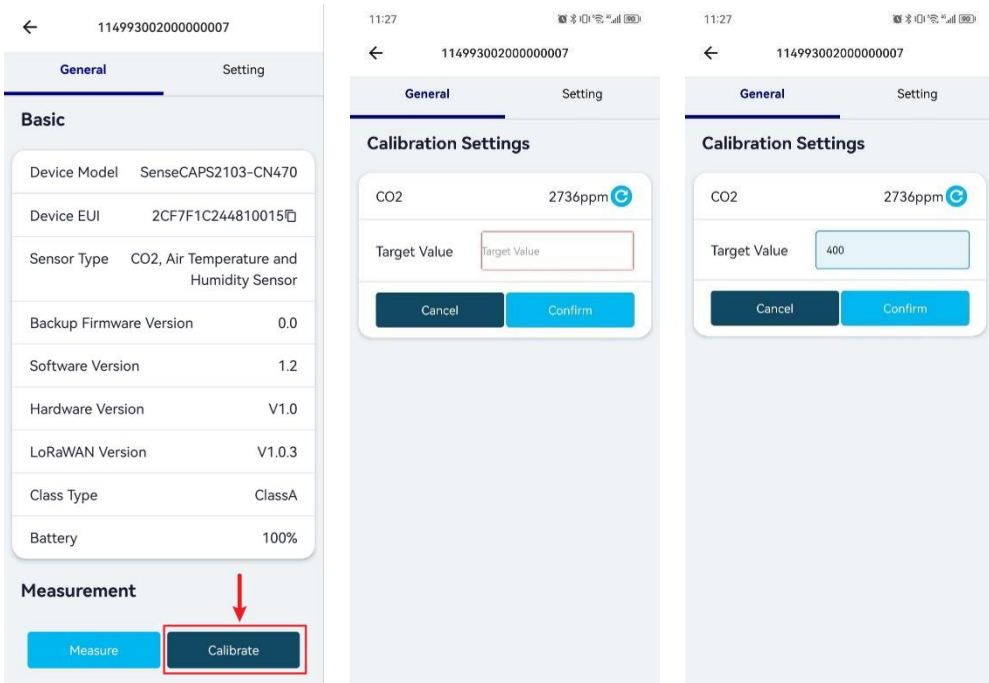

3) Input the CO2 value of current CO2 level.

4) If you click to get the current measurement value, please wait for 2 minutes as the sensor needs to be warm-up before accurate measurements can be obtained.

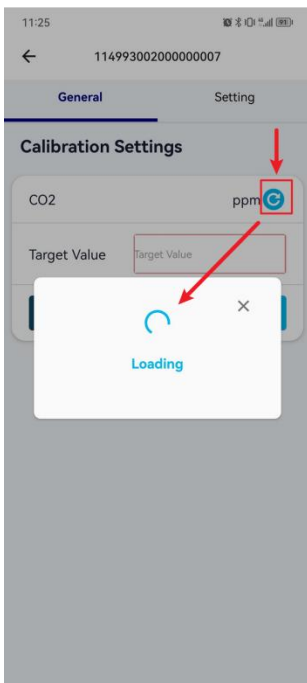



13.3 S2104 and S2105: Calibration of Soil Moisture and EC



Note:



The device has been calibrated before delivery. In most scenarios, calibration is not required.

We initially opened calibration options, but due to user error operation leading to measurement algorithm errors, we have disabled user calibration functions. If special calibration is required, users need to contact the SenseCAP team. Alternatively, users can choose to use the S2100 Data Logger with RS485 soil sensors for calibration purposes.

13.4 S2106: Calibration of pH

When performing the PH calibration, you should guarantee the temperature of the standard PH calibration solution is around 25°C. And wait a while for temperature and PH equilibrium after immersing the sensor into the standard solution. Please use PH=4.01, 7.00, 10.01 standard PH solution for calibration.

Get these things ready:

Picture	Type	Quantity
	S2106 pH Sensor	1
	pH Standard Liquid: pH 4.01, pH7.00, pH10.01	1



	Graduated Cylinder	1
---	--------------------	---

1) Use the app to connect to Bluetooth and open the configuration page.

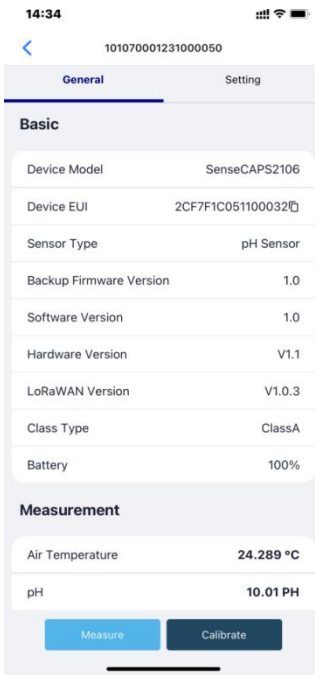

2) Prepare the standard liquid and pour an appropriate amount of the liquid into the graduated cylinder. Insert the pH probe electrode into the liquid in the graduated cylinder.





3) Click the Calibrate button and select the corresponding pH value.

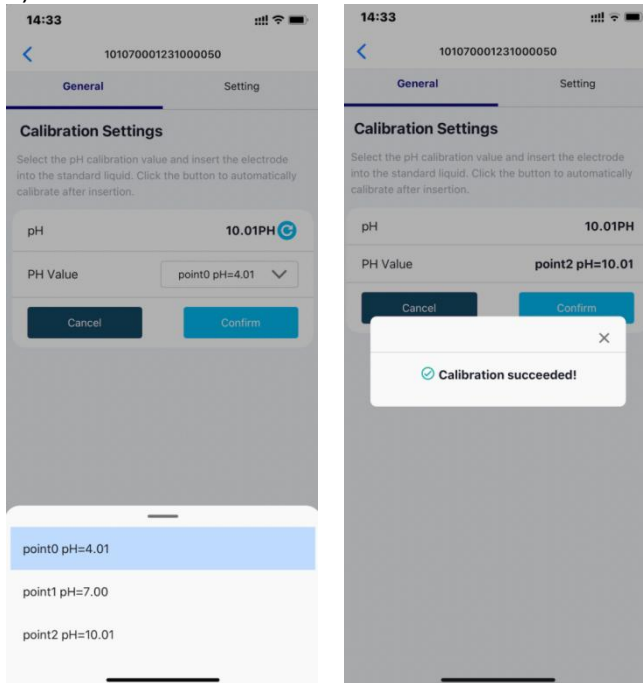

- 4) Click icon to measure the current pH Value. Click “Confirm” to complete the calibration.
- 5) Calibrate the remaining two liquid in the same way.



14. Trouble Shooting

14.1 Sensors can't join LoRa network, how to do?

- 1) Check the gateway frequency configuration. Make sure the gateway and Sensor Node have the same uplink and downlink frequency.
- 2) Check the real-time log and RESET the sensor to see if there are any sensor data packets. If there are packets, check whether the gateway is sending downlink packets.
- 3) If the channels and other configurations are correct and the gateway logs do not have packets, please contact technical support.

14.2 Why is the new sensor's battery not 100%?

Battery power detection is not high precision. Its principle is to measure the supply voltage, when the power is turned on and repeatedly RESET, the voltage is unstable, so it is not 100%. When the sensor is stable, the power will be more accurate.

14.3 Battery Life Prediction

The power consumption table is for reference only. The battery life depends on various factors, such as frequency band, distance from the gateway, and ambient temperature.

https://files.seeedstudio.com/products/SenseCAP/S210X/SenseCAP_S21XX_Sensor_Battery_Life_Prediction.xlsx

14.4 Support

Support is provided Monday to Friday, from 09:00 to 18:00 GMT+8. Due to different time zones, we cannot offer live support. However, your questions will be answered as soon as possible in the before-mentioned schedule.

Provide as much information as possible regarding your enquiry (product models, accurately describe your problem and steps to replicate it etc.) and send a mail to: sensecap@seeed.cc

14.5 Document Version

Version	Date	Description	Editor
V1.0.0	5/01/2022	First edition	Jenkin Lu
V1.0.1	6/14/2022	Add App description	Jenkin Lu
V1.0.2	7/21/2022	Delete some steps	Jenkin Lu



V1.0.3	11/11/2022	Add Platform in 6.2,6.3	Lee
V1.0.4	6/1/2023	Add calibration method	Jenkin Lu
V1.0.5	6/25/2023	Add Error code	Lee
V1.0.6	7/25/2023	Update App setting	Lee
v1.0.7	10/13/2023	Add S2107/S2108 description	Lee