



AI Workplace Occupancy Sensor

VS121-P

User Guide



Safety Precautions

Milesight will not shoulder responsibility for any loss or damage resulting from not following the instructions of this operating guide.

- ❖ The device must not be disassembled or remodeled in any way.
- ❖ To avoid risk of fire and electric shock, do keep the product away from rain and moisture before installation.
- ❖ Do not place the device where the temperature is below/above the operating range.
- ❖ Do not touch components which may be hot.
- ❖ The device must never be subjected to shocks or impacts.
- ❖ Make sure the device is firmly fixed when installing.
- ❖ Make sure the plug is firmly inserted into the power socket.
- ❖ Do not expose the device to where a laser beam equipment is used.
- ❖ Use a soft, dry cloth to clean the lens of the device. Stubborn stains can be removed using a cloth dampened with a small quantity of detergent solution, then wipe them dry.

Declaration of Conformity

VS121-P is in conformity with the essential requirements and other relevant provisions of the CE, FCC, and RoHS.

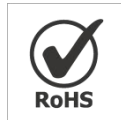

Copyright © 2011-2023 Milesight. All rights reserved.

All information in this guide is protected by copyright law. Whereby, no organization or individual shall copy or reproduce the whole or part of this user guide by any means without written authorization from Xiamen Milesight IoT Co., Ltd.

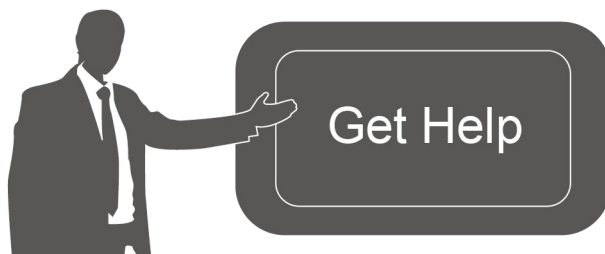

For assistance, please contact

Milesight technical support:

Email: iot.support@milesight.com

Support Portal: support.milesight-iot.com

Tel: 86-592-5085280

Fax: 86-592-5023065

Address: Building C09, Software Park
Phase III, Xiamen 361024,
China

Revision History

Date	Doc Version	Description
March 15, 2023	V 1.0	Initial version
April 20, 2023	V 1.1	Add installation height of high ceiling mount version
July 15, 2023	V 1.2	<ol style="list-style-type: none">1. Add people flow analysis feature;2. Support MQTT/MQTTS transmission;3. Add DO overcrowding alarm feature;4. Add DI filer staff/deliverer feature;5. Reporting interval range is extended to 5~86400s;6. Adjust illuminance of region people counting.

Contents

1. Product Introduction	5
1.1 Overview	5
1.2 Key Features	5
2. Hardware Introduction	5
2.1 Packing List	5
2.2 Hardware Overview	6
2.3 Reset Button and LED Indicator	6
2.4 Dimensions (mm)	7
3. Power Supply	7
4. Access the Sensor	7
5. Operation Guide	9
5.1 Live Video	9
5.2 Network	10
5.2.1 TCP/IP	10
5.2.2 RTSP	11
5.3 People Counting	12
5.3.1 Region People Counting	12
5.3.2 Line Crossing Counting	16
5.3.3 People Flow Analysis	19
5.3.4 Recognition Scheme	22
5.3.5 Privacy Mask	22
5.4 System	23
5.4.1 User	23
5.4.2 System Info	24
5.4.3 Date & Time	25
5.4.4 Remote Management	25
5.4.5 System Maintenance	26
5.4.6 Security Service	27
5.4.7 About	28
6. Mount the Sensor	28
6.1 Recommended Height for Certain Object	28
6.2 Illuminance Requirements for AI Analysis	28
6.3 Recommended Installation for Line Crossing Counting	29
6.5 Ceiling Installation	30
7. Communication Protocol	31
7.1 Region People Counting	31
7.2 Line Crossing Counting	34
7.3 People Flow Analysis	35

1. Product Introduction

1.1 Overview

Milesight VS121 is an AI workplace sensor designed to monitor occupancy and utilization in modern workspace, which can reach up to 98% recognition rate based on AI algorithm. Besides, the precise data collection and multiple privacy-friendly modes make it more user-friendly.

With PoE transmission, VS121 is available for more applications. And it equips rich serial interfaces such as DI, DO and RS485 for various scenarios. VS121 supports data push via HTTP/MQTT/MQTTS for easily integration and allows for remote management via Milesight DeviceHub.

1.2 Key Features

- Recognition rate of up to 98% based on the advanced AI identification and analysis technology and wide detection range
- Support both people counting and occupancy detection
- Support up to 16 mapped regions for detection
- Allow for bi-direction line crossing people counting
- Support U-turn detection for effective data and precise detection
- Support people flow analysis to calculate the traffic from different directions
- Support both normal mode, blur mode, and privacy mask for up to 8 regions
- Support schedule detection
- Support Milesight DeviceHub management
- Adapt to more applications with rich industrial interfaces
- Support transmitting people counting and occupancy data via HTTP Post/MQTT/MQTTS

2. Hardware Introduction

2.1 Packing List

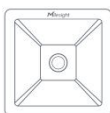

1 × VS121-P
Device



4 × Wall Mounting
Kits

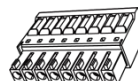

1 ×
Terminal Block

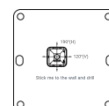

1 × Mounting
Sticker



1 × Quick Start Guide



1 ×
Warranty Card

! If any of the above items is missing or damaged, please contact your sales representative.

2.2 Hardware Overview

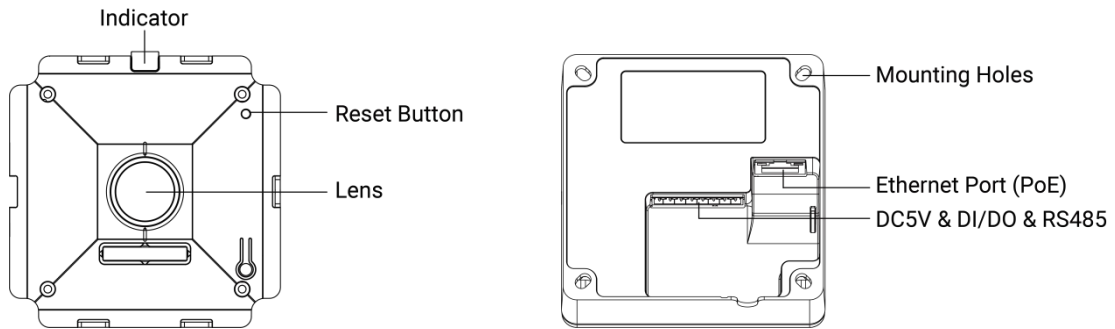

PIN	RS485	DO	DI	Power	Description
1	---	---	---	DC 5V	Positive
2	---	---	---	GND	Negative
3	---	---	DI	---	Wet contact, low level: $\leq 0.5V$, high level: 3-5V
4	---	---	G	---	Ground
5	---	DO	---	---	Wet contact, support devices: 3.3V~12V, $\leq 500mA$
6	---	COM	---	---	Common Ground
7	B	---	---	---	Receive Data
8	A	---	---	---	Transmit Data

2.3 Reset Button and LED Indicator

Function	Action	LED Indication
On/Off Status	Power on or off the device.	On: Device is on
		Off: Device is off
Reset to Factory Default	Press and hold the reset button for more than 10 seconds.	Blink constantly.

2.4 Dimensions (mm)

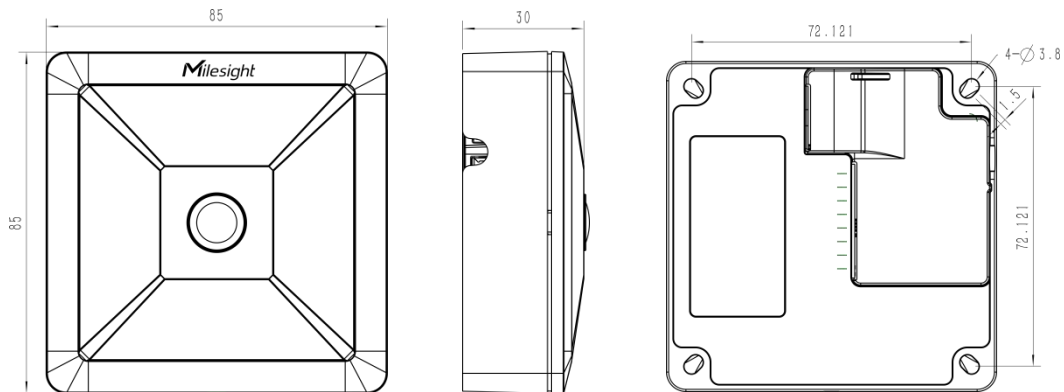

3. Power Supply

VS121-P can be powered by 802.3af standard PoE or DC 5V power adapter. Choose one of the following methods to power up the device.

- Powered by PoE Switch

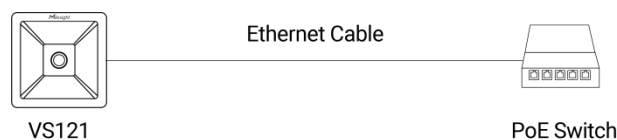

- Powered by PoE Injector

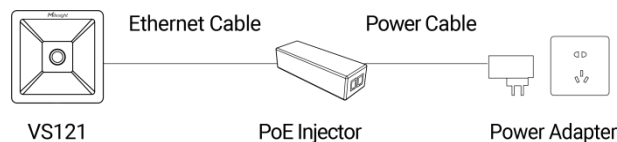

- Powered by DC Power Adapter

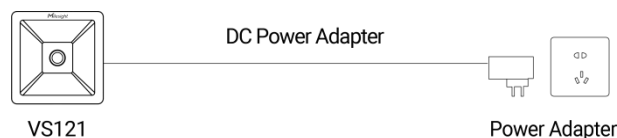

4. Access the Sensor

VS121-P provides user-friendly web GUI for configuration and users can get access to it via Ethernet port. The recommended browsers are Chrome, Microsoft Edge, and Safari. The default Ethernet IP of the sensor is **192.168.5.220** (can be found on the label).

Step 1: Power on the device and connect the Ethernet port to a PC.

Step 2: Change the IP address of computer to 192.168.5.0 segment as below:

- Go to **Start** → **Control Panel** → **Network and Internet** → **Network and Sharing Center** → **Ethernet** → **Properties** → **Internet Protocol Version 4 (TCP/IPv4)**.

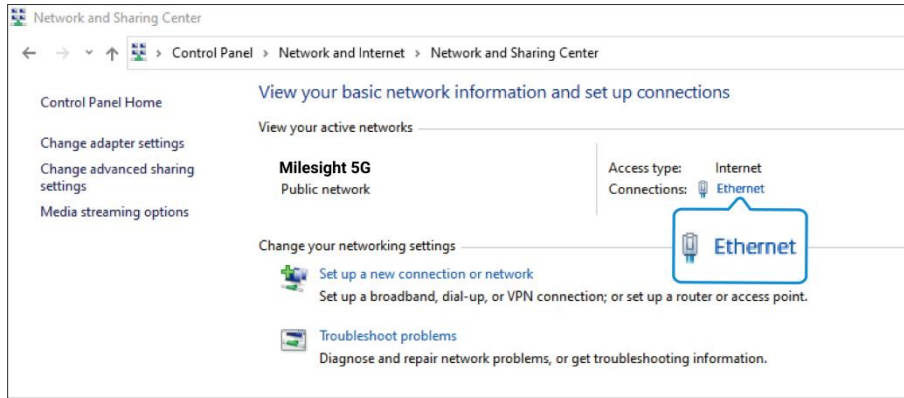

- b. Enter an IP address that in the same segment with sensor (e.g. 192.168.5.61, but please note that this IP address shall not conflict with the IP address on the existing network);

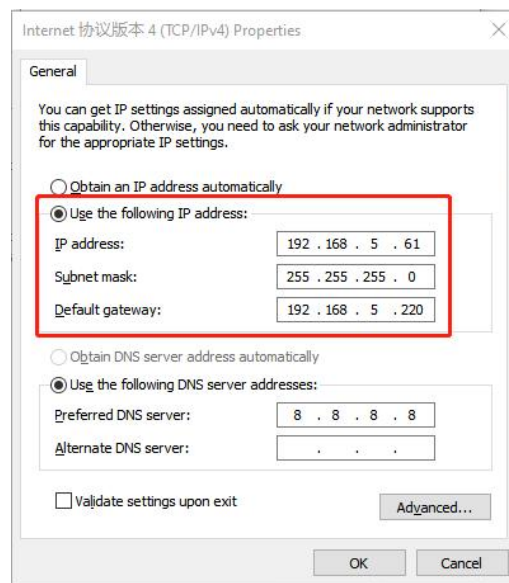

Step 3: Open the Browser and type 192.168.5.220 to get access to the GUI.

Step 4: Select the language.

Step 5: Users need to set the password and privacy mode when using the sensor for the first time. And, three security questions can also be set optionally. After configuration, use username (admin) and custom password to log in the sensor.

Note:

- 1) Password must be 8 to 32 characters long, containing at least one number and one letter.
- 2) You can click the "forgot password" in login page to reset the password by answering three security questions when you forget the password, if you set the security questions in advance.
- 3) If you need to reset the privacy mode, hold on reset button for 10s to reset device to factory default.

The first screenshot shows the 'Activation' screen with a language dropdown set to 'English'. It contains three input fields: the first is pre-filled with 'admin', the second and third are masked with asterisks. A blue 'NEXT' button is at the bottom.

The second screenshot shows the 'Activation' screen with 'Privacy Mode' options: 'Blur' (selected) and 'Normal'. A note explains: 'Note: Blur: Low resolution blurring B/W video stream. Normal: No processing of video stream.' A blue 'NEXT' button is at the bottom.





The third screenshot shows the 'Security Question Settings' screen with a language dropdown set to 'English'. It has three question-answer pairs, each with a dropdown menu for the question and a text input for the answer. The questions are all 'What's your father's name?'. 'Skip' and 'Finish' buttons are at the bottom.

5. Operation Guide

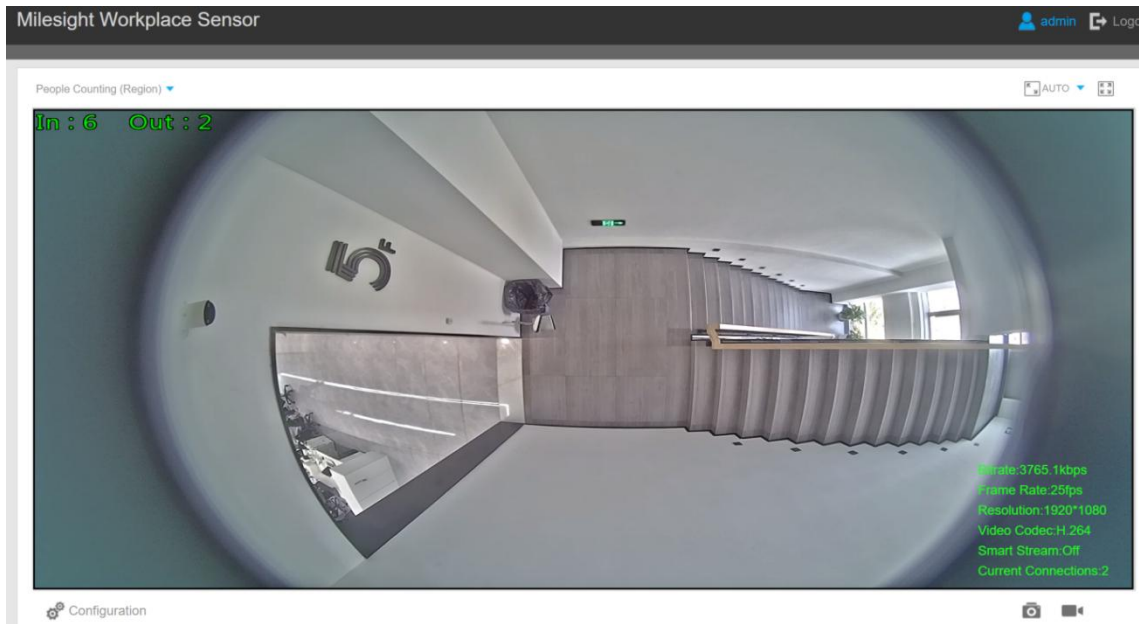
5.1 Live Video

After logging on to the device web GUI successfully, user is allowed to view live video as follows.



Parameters	Description
 Configuration	Click to access the configuration page.
People Counting (Region) ▼	<p>People Counting (Region): show the mapped or non-mapped regions of people counting.</p> <p>Line Crossing Counting: show the detection line and counting people it detected.</p> <p>People Flow Analysis: show the detection area and people it detected.</p>
 Snapshot	Click to capture the current image. Note: this option is only available for normal privacy mode.
 Start/Stop Recording	Click to Start Recording video, click again to Stop Recording . Note: this option is only available for normal privacy mode.
 Windows Size & real size	Click to display images at a windows size.

5.2 Network

5.2.1 TCP/IP

Network

TCP/IP

RTSP

Get IPv4 address automatically
 Use fixed IPv4 address

IP Address:	192 . 168 . 68 . 71	Test
IPv4 Subnet Mask:	255 . 255 . 255 . 0	
IPv4 Default Gateway:	192 . 168 . 68 . 1	
Preferred DNS Server:	8 . 8 . 8 . 8	
IPv6 Mode:	Manual	▼
IPv6 Address:		
IPv6 Prefix:		
IPv6 Default Gateway:		
MTU:	1500	Bytes (1200~1500)

[Save](#)

Parameters	Description
IP Address	An address that used to identify the sensor on the network.
Test	Click test button to test if the IP address is conflicting.
IPv4 Subnet Mask	It is used to identify the subnet where the sensor is located.
IPv4 Default Gateway	The default router address.
Preferred DNS Server	The DNS Server translates the domain name to IP address.
IPv6 Mode	Select from "Manual", "Router Advertisement" or "DHCPv6".
IPv6 Address	IPv6 address used to identify the sensor on the network.
IPv6 Prefix	Define the prefix length of IPv6 address.
IPv6 Default Gateway	The default router IPv6 address.
MTU	Maximum transmission unit. The default value is 1500. Range: 1200~1500.

5.2.2 RTSP

RTSP is only available for Normal privacy mode.

Network

TCP/IP **RTSP**

RTSP Port:	<input type="text" value="52786"/>	
RTP Packet:	<input type="text" value="Better Compatibility"/>	▼
Multicast Group Address:	<input type="text" value="239 . 6 . 6 . 6"/>	
QoS DSCP(0~63):	<input type="text" value="0"/>	

[Save](#)

Parameters	Description
RTSP Port	The port of RTSP, the default is 554.
RTP Packet	Select from "Better Compatibility" and "Better Performance".
Multicast Group Address	Configure the address of multicast group.
QoS DSCP	The valid value range of the DSCP is 0-63.

RTSP URL

Stream	URL
Primary Stream	rtsp://IP:RTSP Port/main

Note:

- DSCP refers to the Differentiated Service Code Point, the value of DSCP is used in the IP header to indicate the priority of the data.
- A reboot is required for the settings to take effect.

5.3 People Counting

5.3.1 Region People Counting

Users can set the report settings and detection regions here.

Enable:	<input type="checkbox"/>
Number of People:	0
Settings	
Report Regularly:	<input checked="" type="checkbox"/>
Reporting Interval (s):	<input type="text" value="300"/>
Report by Result:	<input checked="" type="checkbox"/>
Mode:	<input type="text" value="Zero⇌Non-zero"/>
Report Protocol:	<input checked="" type="radio"/> MQTT <input type="radio"/> MQTTS <input type="radio"/> HTTP
Host:	<input type="text"/>
Port:	<input type="text"/>
ClientID:	<input type="text"/>
Username:	<input type="text"/>
Password:	<input type="text"/>
Topic:	<input type="text"/>
QoS:	<input type="text" value="QoS 0"/>
Overcrowding Alarm:	<input checked="" type="checkbox"/> ⓘ
Trigger Type:	<input checked="" type="radio"/> Total Number <input type="radio"/> Number in Area
Trigger Threshold:	<input type="text" value="20"/>

Parameters	Description
Enable	Enable or disable region people counting feature.
Number of People	Show current number of people.
Report Regularly	Report the current number of people according to reporting interval. Reporting Interval: 5-86400 s, default: 300 s
Report by Result	Report according to the following changes of people number result: <ul style="list-style-type: none"> ● Zero to Non-zero/Non-zero to Zero ● Once result changes
Report Protocol	Select the protocol to send people counting data, MQTT, MQTTS or HTTP is optional.
Overcrowding Alarm	When the number of people is over the trigger threshold, the DO and COM will be broken, when the number is within the threshold, DO and COM be spliced.
Trigger Type	Select the trigger type. If there is not area, the trigger type is total people number of live view. Total number: total people number of all drawn areas. Number in area: the number of people in any one area.
Trigger Threshold	The threshold people number to trigger the DO.
HTTP	
HTTP Notification	Select among "URL 1", "URL 2" and "URL 3".

URL	
Enable	Enable or disable to configure URL and Username/Password.
HTTP Method	Fixed as Post.
Snapshot	Enable or disable the snapshot feature. Note: the option is only available for normal privacy mode.
URL	The device will post the people counting data in json format to this URL.
User Name	The username used for authentication.
Password	The password used for authentication.
MQTT/MQTTS	
Host	MQTT broker address for receiving data.
Port	MQTT broker port for receiving data.
Client ID	Client ID is the unique identity of the client to the server. It must be unique when all clients are connected to the same server, and it is the key to handle messages at QoS 1 and 2.
Username	The username used for connecting to the MQTT broker.
Password	The password used for connecting to the MQTT broker.
Topic	Topic name used for publishing.
QoS	QoS0, QoS1, and QoS2 are optional.
Certificate Type	CA Signed Server or Self Signed is optional. CA signed server certificate: verify with the certificate issued by Certificate Authority (CA) that is pre-loaded on the device. Self signed certificates: upload the custom CA certificates, client certificates and secret key for verification.

Set Detection Region

Enable:

Detection Area: Mapped Region ▼

Reporting Type: Occupancy ▼



Clear

Parameters

Description

Enable	Enable the detection area customization feature. If disabled, the whole area will be the detection area.
Detection Area	Select the customized area as either mapped or except mapped area. You can draw the area in the below screen. 16 regions can be set at most. Mapped Region: Only people who are in the mapped region will be detected. Non-mapped Region: Only people who are not in the mapped region will be detected. Note: when drawing the area, right click the mouse can make the area closed.
Reporting Type	When detection area is in Mapped Region type, users can select two reporting types: Occupancy: upload the occupancy status of per mapped region as 0 or 1. Region People Counting: upload the specific number of people of per mapped region. Note that the device allows to report the number in the 16 regions at most.
	Zoom up the live view to draw the areas.
Clear	Clear all areas you have drawn before.

Schedule Settings

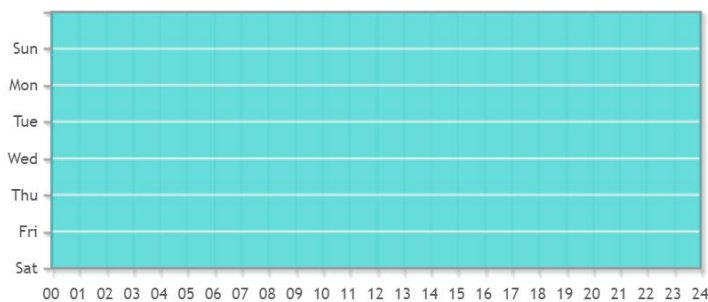

Edit

Milesight Workplace Sensor ✕

Time Schedule

	Period1	Period2	Period3	
<input checked="" type="checkbox"/> Sunday	00 : 00 - 24 : 00	00 : 00 - 00 : 00	00 : 00 - 00 : 00	Copy to Other Days
<input checked="" type="checkbox"/> Monday	00 : 00 - 24 : 00	00 : 00 - 00 : 00	00 : 00 - 00 : 00	Copy to Other Days
<input checked="" type="checkbox"/> Tuesday	00 : 00 - 24 : 00	00 : 00 - 00 : 00	00 : 00 - 00 : 00	Copy to Other Days
<input checked="" type="checkbox"/> Wednesday	00 : 00 - 24 : 00	00 : 00 - 00 : 00	00 : 00 - 00 : 00	Copy to Other Days
<input checked="" type="checkbox"/> Thursday	00 : 00 - 24 : 00	00 : 00 - 00 : 00	00 : 00 - 00 : 00	Copy to Other Days
<input checked="" type="checkbox"/> Friday	00 : 00 - 24 : 00	00 : 00 - 00 : 00	00 : 00 - 00 : 00	Copy to Other Days
<input checked="" type="checkbox"/> Saturday	00 : 00 - 24 : 00	00 : 00 - 00 : 00	00 : 00 - 00 : 00	Copy to Other Days

Save
Reset

Parameters	Description
Edit	Click Edit button to configure the time schedule.
Reset	Reset the time schedule to factory default.

5.3.2 Line Crossing Counting

The sensor will count the number of people who cross a defined virtual line, then upload the counting data according to the reporting interval.

Enable:	<input type="checkbox"/>
Reporting Interval (s):	<input type="text" value="300"/>
Filter U-turns:	<input type="checkbox"/>
Filter Staff/Deliverer:	<input type="checkbox"/> ⓘ
Report Protocol:	<input checked="" type="radio"/> MQTT <input type="radio"/> MQTTS <input type="radio"/> HTTP
Host:	<input type="text"/>
Port:	<input type="text"/>
ClientID:	<input type="text"/>
Username:	<input type="text"/>
Password:	<input type="text"/>
Topic:	<input type="text"/>
QoS:	<input type="text" value="QoS 0"/> ▼

Parameters	Description
Enable	Enable or disable line crossing counting feature.
Reporting Interval	Report the count value of people in/out during the reporting interval, the device will clean the previous values to re-count after reported, range: 5-86400 s, default: 300 s
Filter U-turns	When enabled, it allows to draw an area and the device will count the in and out values only when people cross along this area.
Filter Staff/Deliverer	A physical button should be set at the entrance, and the button signal should be inputted into the device via DI interface to realize collaboration. The next one count will be discarded in 8 seconds once a signal is detected via DI.
Report Protocol	Select the protocol to send people counting data, MQTT, MQTTS or HTTP is optional.

HTTP

HTTP Notification URL	Select among "URL 1", "URL 2" and "URL 3".
Enable	Enable or disable to configure URL, Username/Password.
HTTP Method	It's fixed as Post.
Snapshot	Enable or disable the snapshot feature. Note: the option is only available for normal mode.
URL	The device will post the people counting data in json format to this URL.
User Name	The username used for authentication.
Password	The password used for authentication.

MQTT/MQTTs

Host	MQTT broker address for receiving data.
Port	MQTT broker port for receiving data.
Client ID	Client ID is the unique identity of the client to the server. It must be unique when all clients are connected to the same server, and it is the key to handle messages at QoS 1 and 2.
Username	The username used for connecting to the MQTT broker.
Password	The password used for connecting to the MQTT broker.
Topic	Topic name used for publishing.
QoS	QoS0, QoS1, and QoS2 are optional.
Certificate Type	CA Signed Server or Self Signed is optional. CA signed server certificate: verify with the certificate issued by Certificate Authority (CA) that is pre-loaded on the device. Self signed certificates: upload the custom CA certificates, client certificates and secret key for verification.

Set Detection Line

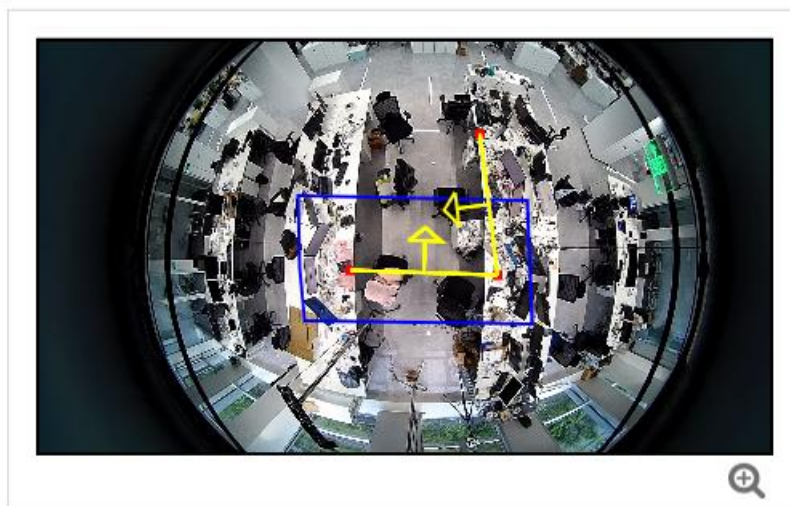

Draw Area Draw Line

Clear Line

Parameters	Description
Set Detection Line	The device allows to set up only one line with at most 4 segments. For the detection line, crossing along the direction of the arrow is "In" and the opposite is "Out". When drawing, left-click to start drawing and drag the mouse to draw a line, left-click again to continue drawing the other segment and right-click the mouse to complete the drawing.
	Zoom up the live view to draw the line or area.
Clear Line	Clear the line you have drawn before.

Clear Area Clear the area you have drawn before.

Schedule Settings

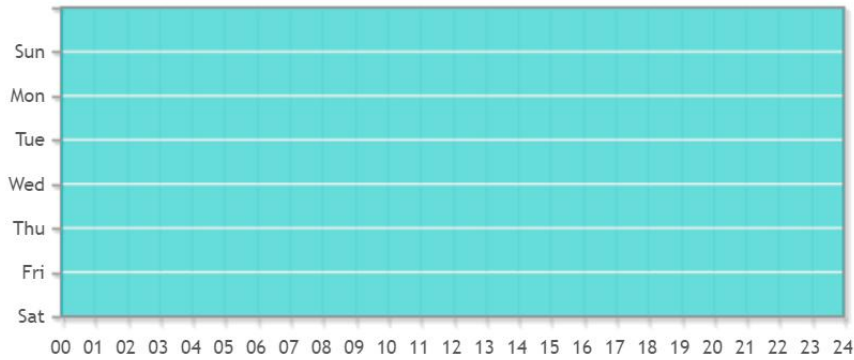

Edit

Milesight Workplace Sensor

Time Schedule

	Period1	Period2	Period3	
<input checked="" type="checkbox"/> Sunday	00:00-24:00	00:00-00:00	00:00-00:00	Copy to Other Days
<input checked="" type="checkbox"/> Monday	00:00-24:00	00:00-00:00	00:00-00:00	Copy to Other Days
<input checked="" type="checkbox"/> Tuesday	00:00-24:00	00:00-00:00	00:00-00:00	Copy to Other Days
<input checked="" type="checkbox"/> Wednesday	00:00-24:00	00:00-00:00	00:00-00:00	Copy to Other Days
<input checked="" type="checkbox"/> Thursday	00:00-24:00	00:00-00:00	00:00-00:00	Copy to Other Days
<input checked="" type="checkbox"/> Friday	00:00-24:00	00:00-00:00	00:00-00:00	Copy to Other Days
<input checked="" type="checkbox"/> Saturday	00:00-24:00	00:00-00:00	00:00-00:00	Copy to Other Days

Save Reset

Parameters	Description
Edit	Click Edit button to configure the time schedule.
Reset	Reset the time schedule to factory default.

Note:

1) The arrow direction of the detection line depends on your drawing direction.

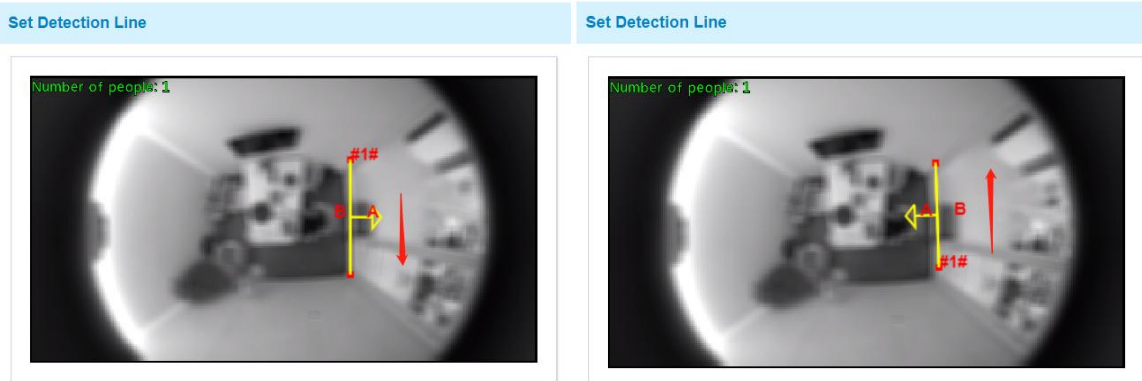

2) Ensure that the detected target can pass through the detection line completely. It's recommended that the detection line is perpendicular to the In/Out direction and on the center of detection area without other objects around.

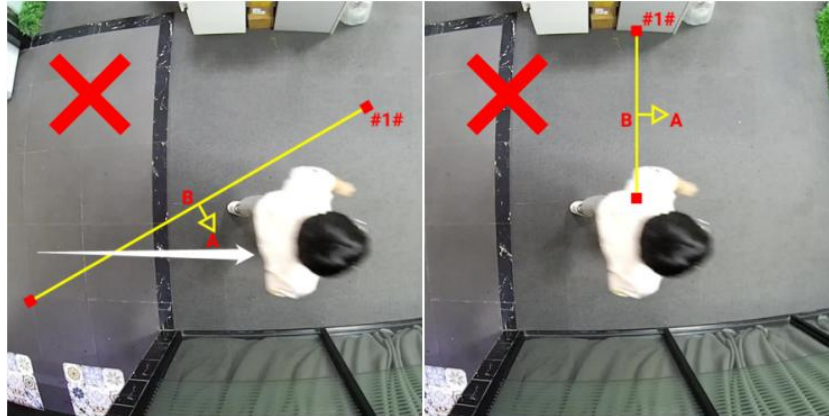

3) A redundant identification area needed to be left on both sides of the detection line for the target. This is to ensure that the sensor has stable recognition and tracking of this target before it passes the detection line, which will make the detection and count more accurate.

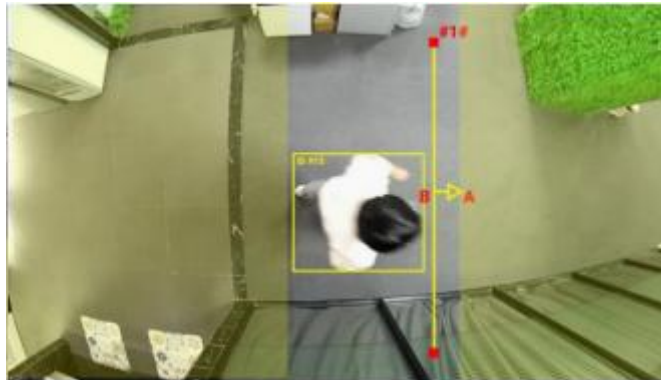

5.3.3 People Flow Analysis

The sensor will count the number of people cross different directions, then upload the counting data according to the reporting interval.

Enable:	<input checked="" type="checkbox"/>
Reporting Interval (s):	<input type="text" value="300"/>
Report Protocol:	<input type="radio"/> MQTT <input checked="" type="radio"/> MQTTS <input type="radio"/> HTTP
Host:	<input type="text"/>
Port:	<input type="text"/>
ClientID:	<input type="text"/>
Username:	<input type="text"/>
Password:	<input type="text"/>
Topic:	<input type="text"/>
QoS:	<input type="text" value="QoS 0"/>
Certificate Type:	<input type="text" value="CA Signed Server"/>

Parameters

Description

Enable	Enable or disable people flow analysis feature.
Report Interval	Report people flow during the reporting interval, the device will clear the previous values to re-count after every reporting. Range: 5-86400 s, default: 300 s
Report Protocol	Select the protocol to send people counting data, MQTT, MQTTS or HTTP optional.
HTTP	
HTTP Notification URL	Select among "URL 1", "URL 2" and "URL 3".
Enable	Enable or disable to configure URL and Username/Password.
HTTP Method	Fixed as Post.
URL	The device will post the people counting data in json format to this URL.
User Name	The username used for authentication.
Password	The password used for authentication.
MQTT/MQTTS	
Host	MQTT broker address for receiving data.
Port	MQTT broker port for receiving data.
Client ID	Client ID is the unique identity of the client to the server. It must be unique when all clients are connected to the same server, and it is the key to handle messages at QoS 1 and 2.
Username	The username used for connecting to the MQTT broker.
Password	The password used for connecting to the MQTT broker.
Topic	Topic name used for publishing.
QoS	QoS0, QoS1, and QoS2 are optional.
Certificate Type	CA Signed Server or Self Signed is optional. CA signed server certificate: verify with the certificate issued by Certificate Authority (CA) that is pre-loaded on the device. Self signed certificates: upload the custom CA certificates, client certificates and secret key for verification.

Set Detection Region



Name:

Clear

Parameters	Description
Set Detection Region	Customize a triangle or a convex quadrangle to count the people flow from one edge to another edge.
Name	Customize the edge name of the detection region.
	Zoom up the live view to draw the areas.
Clear	Clear the area you have drawn before.

Schedule Settings

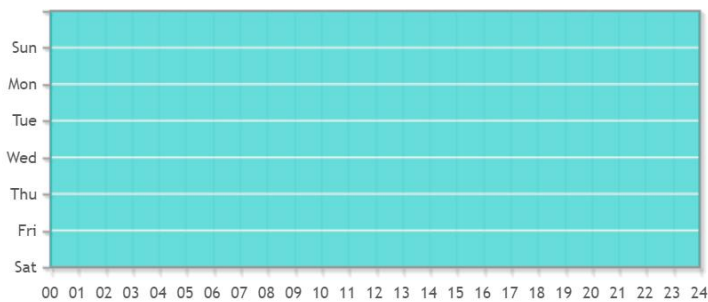

Edit

Milesight Workplace Sensor ✕

Time Schedule

	Period1	Period2	Period3	
<input checked="" type="checkbox"/> Sunday	00:00-24:00	00:00-00:00	00:00-00:00	Copy to Other Days
<input checked="" type="checkbox"/> Monday	00:00-24:00	00:00-00:00	00:00-00:00	Copy to Other Days
<input checked="" type="checkbox"/> Tuesday	00:00-24:00	00:00-00:00	00:00-00:00	Copy to Other Days
<input checked="" type="checkbox"/> Wednesday	00:00-24:00	00:00-00:00	00:00-00:00	Copy to Other Days
<input checked="" type="checkbox"/> Thursday	00:00-24:00	00:00-00:00	00:00-00:00	Copy to Other Days
<input checked="" type="checkbox"/> Friday	00:00-24:00	00:00-00:00	00:00-00:00	Copy to Other Days
<input checked="" type="checkbox"/> Saturday	00:00-24:00	00:00-00:00	00:00-00:00	Copy to Other Days

Save
Reset

Parameters	Description
Edit	Click Edit button to configure the time schedule.
Reset	Reset the time schedule to factory default.

5.3.4 Recognition Scheme

You can select the recognition scheme for region people counting.

Algorithm

Recognition Scheme: Algorithm 1 ⓘ

Image

Power Line Frequency: 50Hz

Wide Dynamic Range: Off

Save

Parameters	Description
Recognition Scheme	<p>Select the recognition scheme based on your detection environment.</p> <p>Algorithm 1: Suitable for monitoring complex environments which have many objects, like office supplies (books, printers, lamps, etc.)</p> <p>Algorithm 2: Suitable for monitoring simple and clean environments like meeting rooms. It is suggested to use Algorithm 2 first.</p>
Image	<p>Power Line Frequency: Select based on your power source frequency standard, 60 Hz and 50 Hz are available.</p> <p>Wide Dynamic Range: This function which can capture and display both bright and dark areas in the same frame that enables details of objects in both bright and dark areas to be visible. It's recommended to enable this function when the scene has a clear contrast between light and dark (such as a corridor).</p>

5.3.5 Privacy Mask

Privacy mask enables to cover certain areas on the live video to prevent certain spots in the

surveillance area from being viewed and prevent people within the area from being counted. You can set 8 mask areas at most.

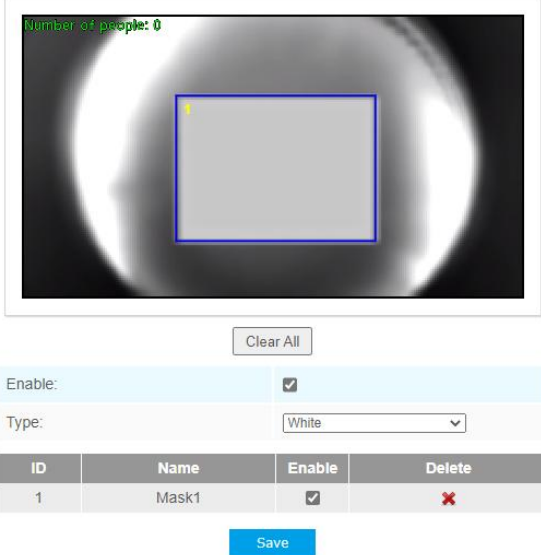

Number of people: 0

Clear All

Enable:

Type: White

ID	Name	Enable	Delete
1	Mask1	<input checked="" type="checkbox"/>	<input type="checkbox"/>

Save

Note: Support up to 8 Privacy Mask areas.

Parameters	Description
Enable	Check the checkbox to enable the Privacy Mask function.
Clear All	Clear all areas you drew before.
Type	Select the color for the privacy areas, there are two colors available: White and Black

5.4 System

5.4.1 User

Security Question

Security Question: [Edit](#)

Account Management

Admin Password:

User Level: Administrator

User Name:

New Password:

Confirm:

Save

Parameters	Description
Security Question	<p>Click Edit button to set three security questions for your device. In case that you forget the password, you can click Forget Password button on login page to reset the password by answering three security questions correctly.</p> <div data-bbox="632 376 1161 779" style="border: 1px solid #ccc; padding: 10px; margin: 10px 0;"> <p style="text-align: center; color: #007bff; font-weight: bold;">Security Question Settings</p> <p>Admin Password: <input type="text"/></p> <p>Security Question1: <input type="text" value="What's your father's name?"/></p> <p>Answer1: <input type="text"/></p> <p>Security Question2: <input type="text" value="What's your father's name?"/></p> <p>Answer2: <input type="text"/></p> <p>Security Question3: <input type="text" value="What's your father's name?"/></p> <p>Answer3: <input type="text"/></p> <p style="text-align: center; color: #007bff; font-weight: bold;">Save</p> </div> <p>There are twelve default questions below, you can also customize the security questions.</p> <div data-bbox="632 869 1161 1160" style="border: 1px solid #ccc; padding: 10px; margin: 10px 0;"> <ul style="list-style-type: none"> <li style="background-color: #007bff; color: white; padding: 2px;">What's your father's name? What's your favorite sport? What's your mother's name? What's your mobile number? What's your first pet's name? What's your favorite book? What's your favorite game? What's your favorite food? What's your lucky number? What's your favorite color? What's your best friend's name? Where did you go on your first trip? Customized Question </div>
Account Management	<p>Admin Password: enter the correct admin password before adding an account.</p> <p>User Level: It's fixed as Administrator.</p> <p>User Name: It's fixed as admin.</p> <p>New Password: Input password for the account.</p> <p>Confirm: Confirm the password.</p>

5.4.2 System Info

All information about the hardware and software can be checked on this page.

System	
Device Name:	<input type="text" value="Workplace Sensor"/>
Product Model:	VS121-P
SN:	6600D0233093
Hardware Version:	V1.0
Software Version:	31.7.0.80-iot2-b2
MAC Address:	24:E1:24:F5:4E:2F

Save

5.4.3 Date & Time

Here you can check and set the system time.

Current System Time	
Date:	08/03/2023
Time:	23:51:18
Set the System Time	
Time Zone:	(UTC-08:00) United States - Paci ▾
Daylight Saving Time:	Automatic ▾
<input checked="" type="radio"/> NTP server	
Server Address:	<input type="text" value="pool.ntp.org"/>
NTP Sync:	<input checked="" type="checkbox"/> Interval: <input type="text" value="1 day"/> ▾
<input type="radio"/> Manual	
Time:	<input type="text" value="08/03/2023 23:34:39"/> 
<input type="radio"/> Synchronize with computer time	
Date:	09/03/2023
Time:	15:51:19

Parameters	Description
Current System Time	Current date & time of the system.
Time Zone	Select a time zone according to your location.
Daylight Saving Time	Enable or disable the daylight saving time.
NTP Server Address	Setup the address of NTP server.
NTP Sync	Update the time according to the interval time regularly.
Time	Set the system time manually.
Synchronize with computer time	Synchronize the system time with the computer.

5.4.4 Remote Management

You can connect the device to the Milesight DeviceHub on this page so that you can manage the sensor centrally and remotely. For more details please refer to [DeviceHub User Guide](#).

DeviceHub	
Status:	Disconnected
Server Address:	<input type="text"/>
Activation Method:	Authentication Code <input type="button" value="v"/>
Authentication Code:	<input type="text"/>

Parameters	Description
Status	Show the connection status between the sensor and DeviceHub.
Server Address	IP address or domain of the DeviceHub.
Activation Method	Select activation method to connect the sensor to DeviceHub sever, the options are "Authentication Code" and "Account".
Authentication Code	Fill in the authentication code generated from the DeviceHub.
Account Name	Fill in the registered DeviceHub account (email) and password.
Password	
Connect/Disconnect	Click the button to connect/disconnect the sensor from the DeviceHub.

5.4.5 System Maintenance

System Upgrade	
Software Version:	31.7.0.78-iot2
Local Upgrade:	<input type="button" value="Choose File"/> No file chosen <input type="button" value="Upgrade"/> <input type="checkbox"/> Reset after Upgrading

Note: Do not disconnect the power of the device during the upgrade.

Maintenance	
Reset	<input checked="" type="checkbox"/> Keep the IP Configuration <input checked="" type="checkbox"/> Keep the User Information <input type="button" value="Reset"/>
Export Config File:	<input type="button" value="Export"/>

Config File:	<input type="button" value="Choose File"/> No file chosen
Import Config File:	<input type="button" value="Import"/>
Reboot	
Reboot the Device:	<input type="button" value="Reboot"/>

Parameters	Description
System Upgrade	<p>Software Version: The software version of the sensor.</p> <p>Local Upgrade: Click the Choose File button and select the upgrading file, then click the Upgrade button to upgrade. After the system reboots successfully, the update is done.</p> <p>You can check Reset after Upgrading to reset the device after upgrading it.</p> <p>Note: Do not disconnect the power of the device during the upgrade process. The device will be restarted to complete the upgrading.</p>
Maintenance	<p>Reset settings: Click Reset button to reset the device to factory default settings</p> <p>Keep the IP Configuration: Check the option to keep the IP information when resetting</p> <p>Keep the User Information: Check this option to keep the user information when resetting</p> <p>Export Config File: Export configuration file.</p> <p>Import Config File: Click the Choose File button and select the configuration file, click Import button to import configuration file.</p>
Reboot	Restart the device immediately

5.4.6 Security Service

SSH Settings	
Enable SSH:	<input type="checkbox"/>
SSH Port:	<input type="text" value="6022"/>
<input type="button" value="Save"/>	

Parameters	Description
Enable SSH	Enable SSH feature.
SSH Port	Set the port to access this sensor via SSH.

5.4.7 About

User can view some open source software licenses about the sensor by clicking the View Licenses button.

Open Source Software Licenses

View Licenses

6. Mount the Sensor

To better utilize the advantages of AI algorithm, there are some important steps to follow :

6.1 Recommended Height for Certain Object

Object	Height	Note
sitting object	>2.5m (8.2ft)	Commonly used for Region People Counting
standing object	>3m (9.8ft) (the optimum height is 3m)	Commonly used for Line Crossing Counting and People Flow Analysis

Recommended detection ranges for region people counting and people flow analysis at different heights:

Version	Height	Recommended detection range
Standard Version	2.5m	3m*4m
	3m	4.4m*5.7m
	3.5m	4.9m*6.4m
	4m	5.6m*7.4m
High Ceiling Mount Version	5m	3.5m*10m
	6m	4.5m*12m
	7m	5.5m*14m

6.2 Illuminance Requirements for AI Analysis

- ❖ Region People Counting
 - We recommend that the illuminance is greater than 20Lux.
 - We recommend enabling WDR function(Turn to [page 22](#)), which will make the image effect better.
- ❖ Line Crossing Counting and People Flow Analysis
 - We recommend that the illuminance is greater than 50Lux.
 - When the illuminance is between 20~50Lux, we recommend disabling WDR function.
 - When the illuminance is >50Lux and the scene has a clear contrast between light and dark (such as a corridor), we recommend enabling WDR function.

To know the illuminance of the current scene, you must use an illuminance meter, or you can refer to the following common environmental illuminance values:

place/environment	illuminance
Indoors at dusk	10Lux
cloudy indoor	5~50Lux
sunny indoor	100~1000Lux

6.3 Recommended Installation for Line Crossing Counting

- Make sure the sensor is facing straight down, in line with the ceiling.

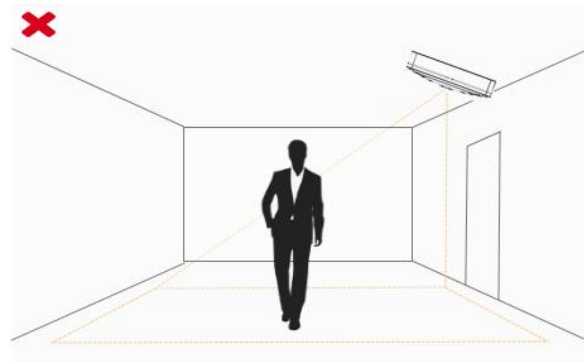
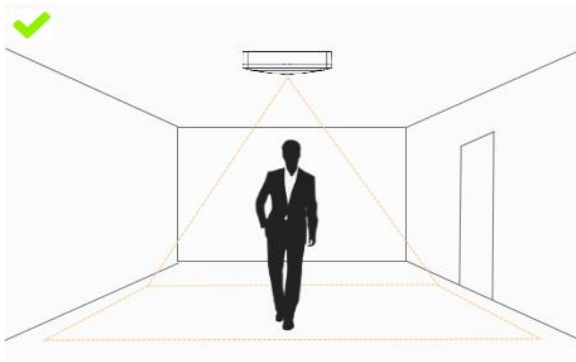

- Make sure there is sufficient white light on site.



- Avoid getting very strong light, like sunlight.

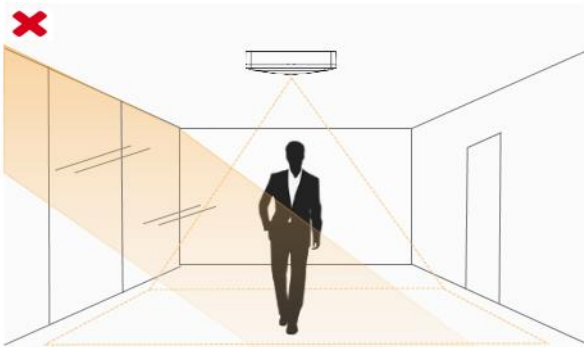

- Make sure there are no moving objects interfering in the counting area. For example, do not install the sensor too close to a door.

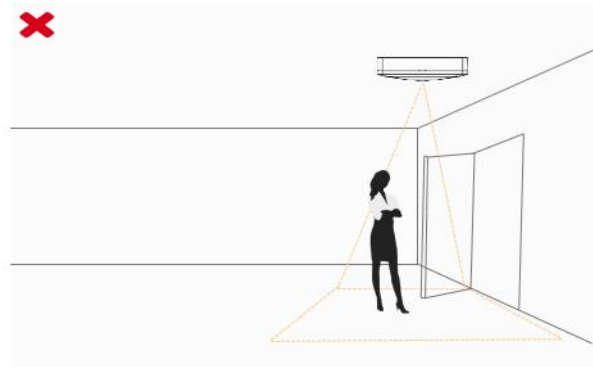
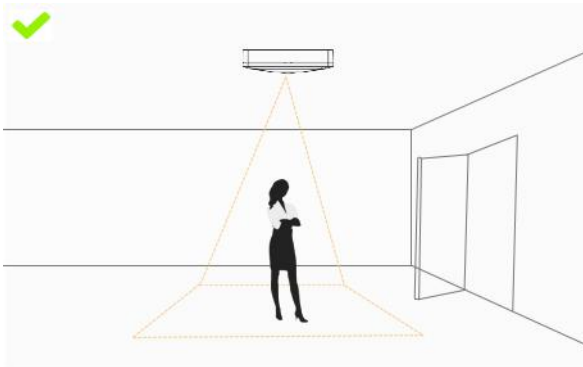

- Avoid installing the sensor near a mirror or avoid drawing the line to the mirror.

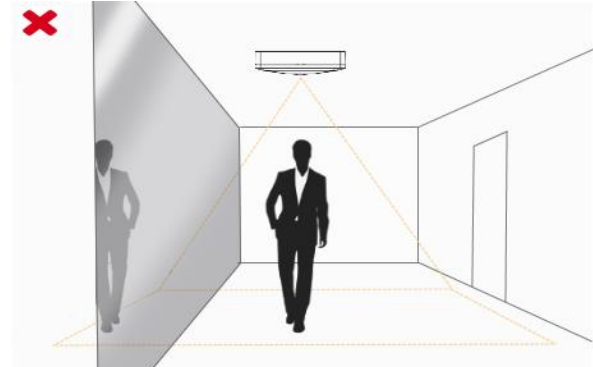
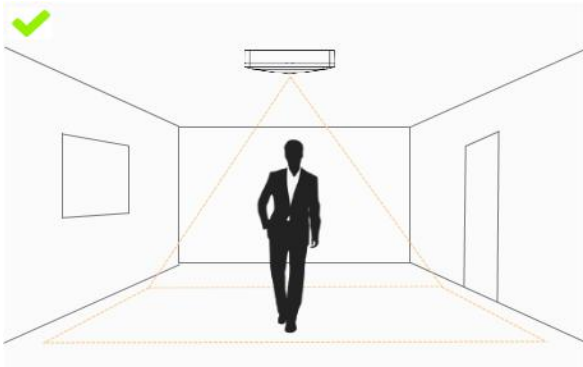

6.4 Factors Affecting Accuracy

- The color of hair or clothes is close to the floor color.

Reason: It will make it difficult for the algorithm to identify the correct object, thus affecting the accuracy.

- The floor color and wall color are black.

Reason: The brightness of the scene will be reduced due to the absorption of light by black.

- The contrast between light and dark in the scene is too strong.

Reason: It will cause the people to be backlight, which will affect the accuracy of the detection.

6.5 Ceiling Installation

Step 1: Ensure the thickness of ceiling is more than 30 mm, then attach the mounting sticker to the ceiling and drill 4 holes with a diameter of 6 mm.

Step 2: Fix the wall plugs into the ceiling holes.

Step 3: Remove the cover on the device, then fix the device to the wall plugs via mounting screws; remember to adjust the mounting direction according to the detection area requirement and direction sticker on the inner cover.

Step 4: Take the cover back to device; note that the Milesight Logo should be facing the LED indicator.

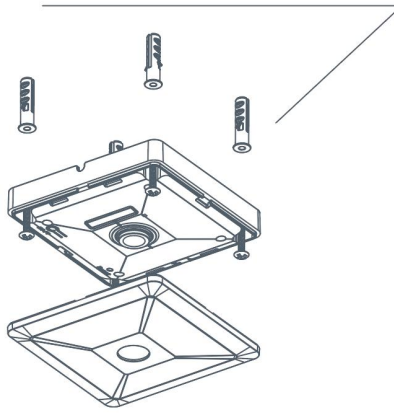

7. Communication Protocol

VS121-P will post the people counting data in json format to HTTP URL or MQTT broker.

7.1 Region People Counting

● Periodic Report

1. Occupancy Status

```
{  
  "event": "Region People Counting",  
  "report_type": "interval",  
  "device_info": {  
    "device": "Workplace Sensor",  
    "device_sn": "369362028335",  
    "device_mac": "00:16:28:FA:8E:68",  
    "ip_address": "192.168.0.99"  
  },  
  "time_info": {  
    "timezone": "UTC+8:00",  
    "start_time": "2022/12/20 18:15:52", //Period start time  
    "end_time": "2022/12/20 19:15:52" //Period end time  
  },  
  "current_total": 10,  
  "max_counted": 12, //Maximum number of people during the reporting interval
```

```

"total_mapped_regions":2,
"numbering_regions":[1,2],
"occupancy":[1,0]
"snapshot":
"/9j/4AAQSkZJRgABAQAAAQABAAD/2wDFABALDA4MChAODQ4SERATGCgaGBY...(Image
code)" //HTTP Post only
}

```

2. Per Region People Counting

```

{
"event":"Region People Counting",
"report_type": "interval",
"device_info":{
"device":"Workplace Sensor",
"device_sn":"369362028335",
"device_mac":"00:16:28:FA:8E:68",
"ip_address":"192.168.0.99"
},
"time_info":{
"timezone": "UTC+8:00",
"start_time":"2022/12/20 18:15:52", //Period start time
"end_time":"2022/12/20 19:15:52" //Period end time
},
"current_total":10,
"Max_counted":12, //Maximum number of people during the reporting interval
"total_mapped_regions":2,
"numbering_regions":[1,2],
"current_counted":[5,5],
"snapshot":
"/9j/4AAQSkZJRgABAQAAAQABAAD/2wDFABALDA4MChAODQ4SERATGCgaGBY...(Image
code)" //HTTP Post only
}

```

● Trigger Report

1. Occupancy Status

```
{  
  "event": "Region People Counting",  
  "device_info": {  
    "device": "Workplace Sensor",  
    "device_sn": "369362028335",  
    "device_mac": "00:16:28:FA:8E:68",  
    "ip_address": "192.168.0.99"  
  },  
  "time_info": {  
    "time": "2022/12/20 18:15:52",  
    "timezone": "UTC+8:00"  
  },  
  "report_type": "trigger",  
  "current_total": 10,  
  "total_mapped_regions": 2,  
  "numbering_regions": [1, 2],  
  "occupancy": [1, 0],  
  "snapshot":  
    "/9j/4AAQSkZJRgABAQAAQABAAD/2wDFABALDA4MChAODQ4SERATGCgaGBY...(Image  
code)" //HTTP Post only  
}
```

2. Per Region People Counting

```
{  
  "event": "Region People Counting",  
  "device_info": {  
    "device": "Workplace Sensor",  
    "device_sn": "369362028335",  
    "device_mac": "00:16:28:FA:8E:68",
```

```
"ip_address": "192.168.0.99"
},
"time_info": {
  "time": "2022/12/20 18:15:52",
  "timezone": "UTC+8:00"
},
"report_type": "trigger",
"current_total": 10,
"total_mapped_regions": 2,
"numbering_regions": [1, 2],
"current_counted": [5, 5],
"snapshot":
"/9j/4AAQSkZJRgABAQAAQABAAD/2wDFABALDA4MChAODQ4SERATGCgaGBY...(Image
code)" //HTTP Post only
}
```

7.2 Line Crossing Counting

● Periodic Report

```
{
  "event": "Line Crossing Counting",
  "report_type": "interval",
  "device_info": {
    "device": "Workplace Sensor",
    "device_sn": "369362028335",
    "device_mac": "00:16:28:FA:8E:68",
    "ip_address": "192.168.0.99"
  },
  "time_info": {
    "timezone": "UTC+8:00",
    "start_time": "2022/12/20 18:15:52", //Period start time
  }
}
```

```

"end_time":"2022/12/20 19:15:52"           //Period end time
},
"in_counted":10,
"out_counted":10,
"capacity_counted":0,//=in_counted-out_counted
"snapshot":
"/9j/4AAQSkZJRgABAQAAAQABAAD/2wDFABALDA4MChAODQ4SERATGCgaGBY...(Image
code)" //HTTP Post only
}

```

7.3 People Flow Analysis

● Periodic Report

```

{
"event":"People Flow Analysis",
"report_type": "interval",
"device_info":{
"device":"Workplace Sensor",
"device_sn":"369362028335",
"device_mac":"00:16:28:FA:8E:68",
"ip_address":"192.168.0.99"
},
"time_info":{
"timezone": "UTC+8:00",
"start_time":"2022/12/20 18:15:52", //Period start time
"end_time":"2022/12/20 19:15:52" //Period end time
},
"flow_data":{
"A-A":10, //Number of people from A to A
"A-B":10, //Number of people from A to B
"A-C":10,
"A-D":10,
"B-A":10,
"B-B":10,
"B-C":10,
"B-D":10,
"C-A":10,
"C-B":10,
"C-C":10,
"C-D":10,
"D-A":10,

```

```
"D-B":10,  
"D-C":10,  
"D-D":10  
}  
}
```

-END-